

Enabling Grip Switch A4EG

CSM_A4EG_DS_E_9_1

Enabling Grip Switch with Distinct Feel for Three Easily Discernible Positions

- In addition to the standard models, the lineup also includes models with an emergency stop switch and models with a momentary operation switch.
- An optional Holding Key (sold separately) provides a versatile method for selecting modes.
- Equipped with conduit connector.



Be sure to read the "Safety Precautions" on page 10.

For the most recent information on models that have been certified for safety standards, refer to your OMRON website.

Features

Positive Operating Feel

Original Double Snap Action switch mechanism lets the operator precisely confirm the enable position.

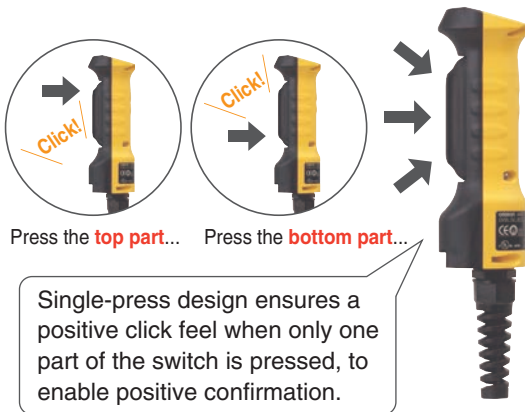

Safety Circuits Are Easy to Configure

Safety circuits can be easily configured by combining the A4EG with the G9SX-GS Safety Guard Switching Unit.

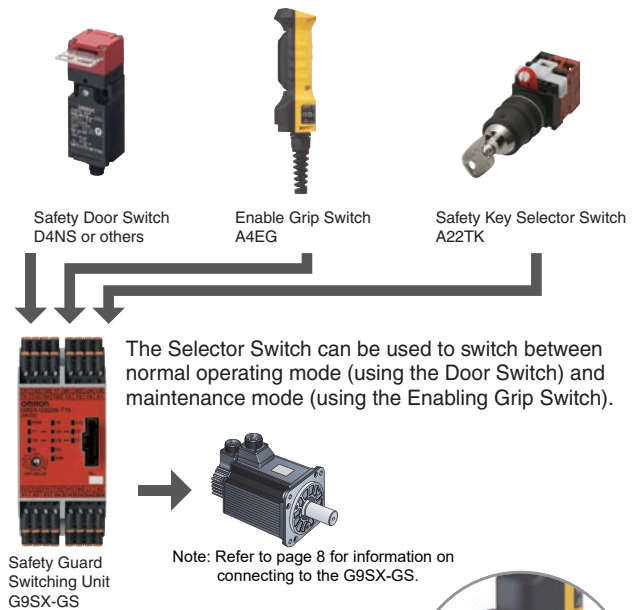

Selection Based on Application

In addition to the standard models, the lineup also includes models with an emergency stop switch and models with a momentary operation switch.





A Holding Key can be used to change modes rather than a key-type selector switch.





Ordering Information

Enabling Grip Switches

Appearance	Contact form			Model
	Enabling switch	Monitor switch	Pushbutton switch	
	Two contacts	1NC (grip output)	None	A4EG-C000041
	Two contacts	None	Emergency stop switch (2NC)	A4EG-BE2R041
	Two contacts	None	Momentary operation switch (2NO)	A4EG-BM2B041

Accessories (Order Separately)

Appearance	Item	Model
	Rubber Cover (replacement part)	A4EG-OP1
	Mounting Bracket (for securing the A4EG)	A4EG-OP2
	Holding Key	A4EG-OP3

Specifications

Standards and EC Directives

Compliance with EC Directives and International Standards

- Low Voltage Directive
- GS-ET-22

Certified Standards

Certifying body	Standard	File No.
TÜV SÜD	EN 60947-5-1 (certified direct opening)	Consult your OMRON representative for details.
UL *	UL 508, CSA C22.2 No.14	E76675
CQC (CCC)	GB/T 14048.5	Consult your OMRON representative for details.
KOSHA	EN60947-5-1	Consult your OMRON representative for details.

* Certification for CSA C22.2 No. 14 by UL is indicated by the .

Certified Standard Ratings (Enabling Switch Section)

TÜV (EN 60947-5-1)

Item	Utilization category	AC-15	DC-13
Rated operating current (Ie)		0.75 A	0.55 A
Rated operating voltage (Ue)		240 V	125 V

Note: Use a 10-A fuse type gI or gG that conforms to IEC 60269 as the short-circuit protection device.
The fuse is not built into the Switch.

UL/CSA (UL 508, CSA C22.2 No.14), CCC (GB/T 14048.5)

- 24 VDC, 0.3 A (inductive load)
- 125 VAC, 1 A (resistive load)

Ratings

Item	Section	Enabling switch	Emergency stop switch (A4EG-BE2R041 only)	Pushbutton (A4EG-BM2B041 only)
Rated insulation voltage		250 V		---
Rated ON current		2.5 A	5 A	0.1 A
Rated load		24 VDC, 0.3 A (inductive load) 125 VAC, 1 A (resistive load) EN certification rating: AC-15 0.75 A/240 V DC-13 0.55 A/125 V	General rating: 125 VAC, 5 A (resistive load) 250 VAC, 3 A (resistive load) 30 VDC, 3 A (resistive load) UL and cUL rating: 125 VAC, 5A (inductive load, power factor: 0.75 to 0.8) 250 VAC, 3 A (inductive load, power factor: 0.75 to 0.8) 30 VDC, 3 A (resistive load) EN certification rating: AC-12 3 A/250 V DC-12 3 A/30 V	General rating: 125 VAC, 0.1 A (resistive load) 8 VDC, 0.1 A (resistive load) 14 VDC, 0.1 A (resistive load) 30 VDC, 0.1 A (resistive load) UL and cUL rating: 125 VAC, 0.1 A (resistive load) 30 VDC, 0.1 A (resistive load) EN certification rating: AC-12 0.1 A/125 V DC-12 0.1 A/30 V
Minimum applicable load		24 VDC, 4 mA		5 VDC, 1 mA

Characteristics

Item	Section	Enabling switch	Emergency stop switch (A4EG-BE2R041 only)	Pushbutton (A4EG-BM2B041 only)
Degree of protection		IP66 (A4EG-C000041), IP65 (A4EG-BE2R041, A4EG-BM2B041)		
Operating section strength		Operating direction: 200 N, 1 min	Operating direction: 367 N, 1 min Rotating direction: 0.49 N·m, 1 min	Operating direction: 50 N, 1 min
Cable pull strength		30 N, 1 min		
Allowable operating frequency	Electrical	20 operations/minute max.	10 operations/minute max. (set/reset for one operation)	60 operations/minute max.
	Mechanical	20 operations/minute max.	10 operations/minute max. (set/reset for one operation)	120 operations/minute max.
Electrical durability		100,000 operations min. (rated load)	100,000 operations min. (set/reset for one operation) (rated load)	100,000 operations min. (rated load)
Mechanical durability		OFF-ON-OFF (direct opening): 100,000 operations min. OFF-ON: 1,000,000 operations min.	100,000 operations min. (set/reset for one operation)	2,000,000 operations min.
Dielectric strength	Between terminals of the same polarity	2,500 VAC, 50/60 Hz, 1 minute (impulse voltage)	1,000 VAC, 50/60 Hz, 1 minute	1,000 VAC, 50/60 Hz, 1 minute
	Between terminals of the different polarity	2,500 VAC, 50/60 Hz, 1 minute (impulse voltage)	2,000 VAC, 50/60 Hz, 1 minute	2,000 VAC, 50/60 Hz, 1 minute
	Between each terminal and non-current carrying metallic parts	2,500 VAC, 50/60 Hz, 1 minute (impulse voltage)	2,000 VAC, 50/60 Hz, 1 minute	2,000 VAC, 50/60 Hz, 1 minute
Insulation resistance		100 MΩ min. (at 500 VDC)		
Vibration resistance	Malfunction	1.5 mm double amplitude, 10 to 55 Hz		
Shock resistance	Malfunction	150 m/s ² max.		
Ambient operating temperature		-10 to 55°C (with no icing or condensation)		
Ambient operating humidity		35% to 85%		
Ambient storage temperature		-25 to 65°C (with no icing or condensation)		
Protection against electric shock		Class II (double insulation) <input type="checkbox"/>		
Pollution degree (operating environment)		3 (EN 60947-5-1)		
Conditional short-circuit current		100 A (EN 60947-5-1)		

Note: The timing of contact outputs for two or more circuits is not synchronized. Confirm performance before application.

Structure and Nomenclature

Structure

A4EG-C000041

A4EG-BE2R041
A4EG-BM2B041

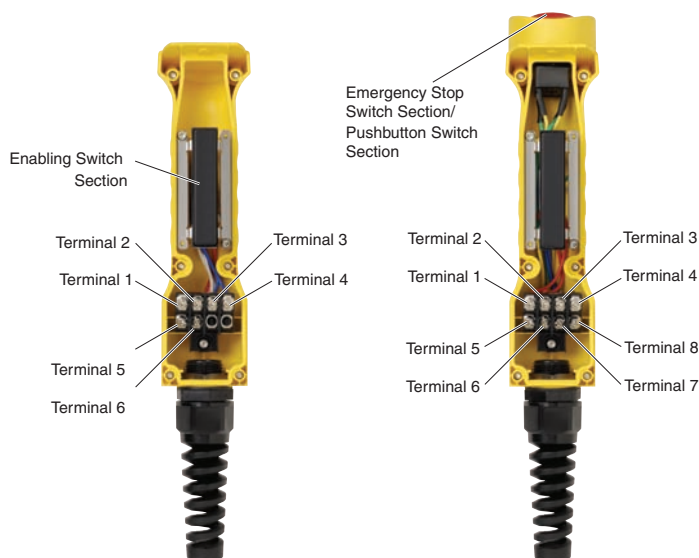

Three Positions: OFF - ON - OFF

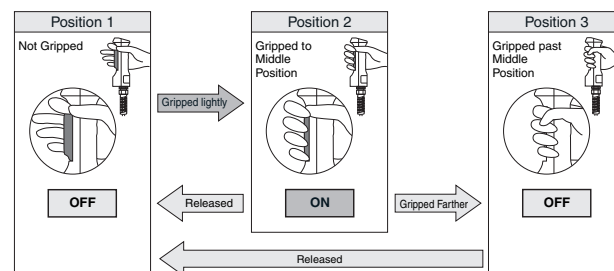

Contact Configuration

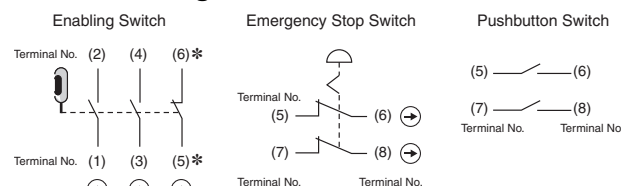

* Terminal No. (5), (6): A4EG-C000041 only

Contact Forms

Operating Patterns

A4EG-C000041

Operation	Terminal No.	Position 1	Position 2	Position 3
Enable output	1 to 2			
	3 to 4			
Grip output	5 to 6			

A4EG-BE2R041

Operation	Terminal No.	Position 1	Position 2	Position 3
Enable output	1 to 2			
	3 to 4			

Pushbutton switch	Terminal No.	Operation	Contact
Emergency stop switch output	5 to 6 7 to 8	Operation (push)	ON → OFF
		Reset (turn reset)	OFF → ON

A4EG-BM2B041

Operation	Terminal No.	Position 1	Position 2	Position 3
Enable output	1 to 2			
	3 to 4			

Pushbutton switch	Terminal No.	Operation	Contact
Pushbutton switch output	5 to 6 (pushbutton switch A) *	Push	OFF → ON
	7 to 8 (pushbutton switch B) *	Push	OFF → ON

* Refer to *Dimensions* on page 6 for information on the positions of pushbutton switches A and B.

- OPEN ON: CLOSED
- CLOSED OFF: OPEN

Note: 1. The contact ON/OFF timing is not synchronized. Confirm performance before application.
2. Direct opening only during grip.

Operating Characteristics

Chart (Enabling Switch Section)

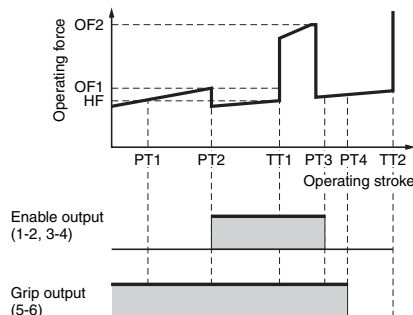

Operating Stroke (Enabling Switch Section)

Operating characteristics	Specified value
Enable output (ON)	PT2 max. 3.6 mm
Max. enable holding position	TT1 Approx. 4.2 mm
Enable direct opening position	PT3 max. 6.0 mm
Max. stroke	TT2 Approx. 6.7 mm

Operating Force (Enabling Switch Section: Reference Values)

Operating characteristics	Specified value
Enable operating force	OF1 max. 14 N
Enable holding force	HF * Approx. 8 N
Grip operating force	OF2 max. 40 N

* HF: Holding force

Operating Force (Emergency Stop Switch Section: Reference Values)

Operating characteristics	Specified value
Operating force	OF max. 14.7 N
Reset force	RF max. 0.1 N·m

Operating Force (Pushbutton Switch Section: Reference Value)

Operating characteristics	Specified value
Operating force	OF max. 4 N

Dimensions

Enabling Grip Switches

A4EG-C00041

Holding Key Mounted

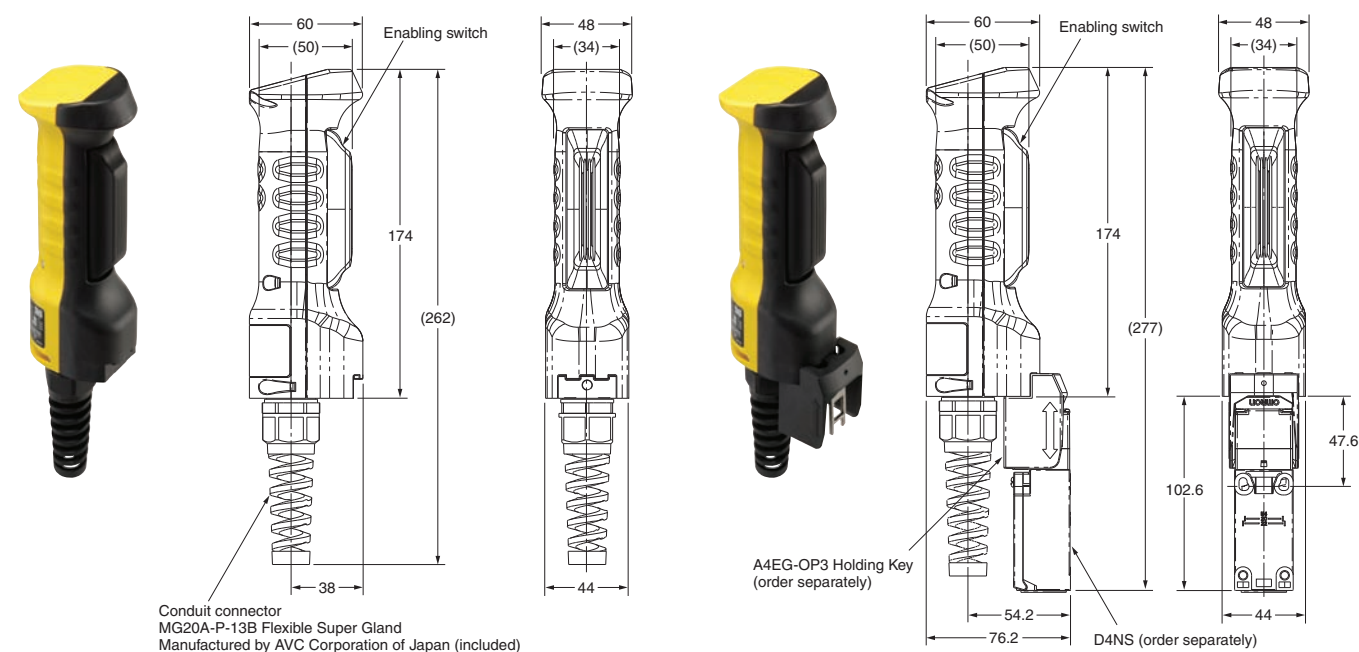

A4EG-BE2R041

Holding Key Mounted

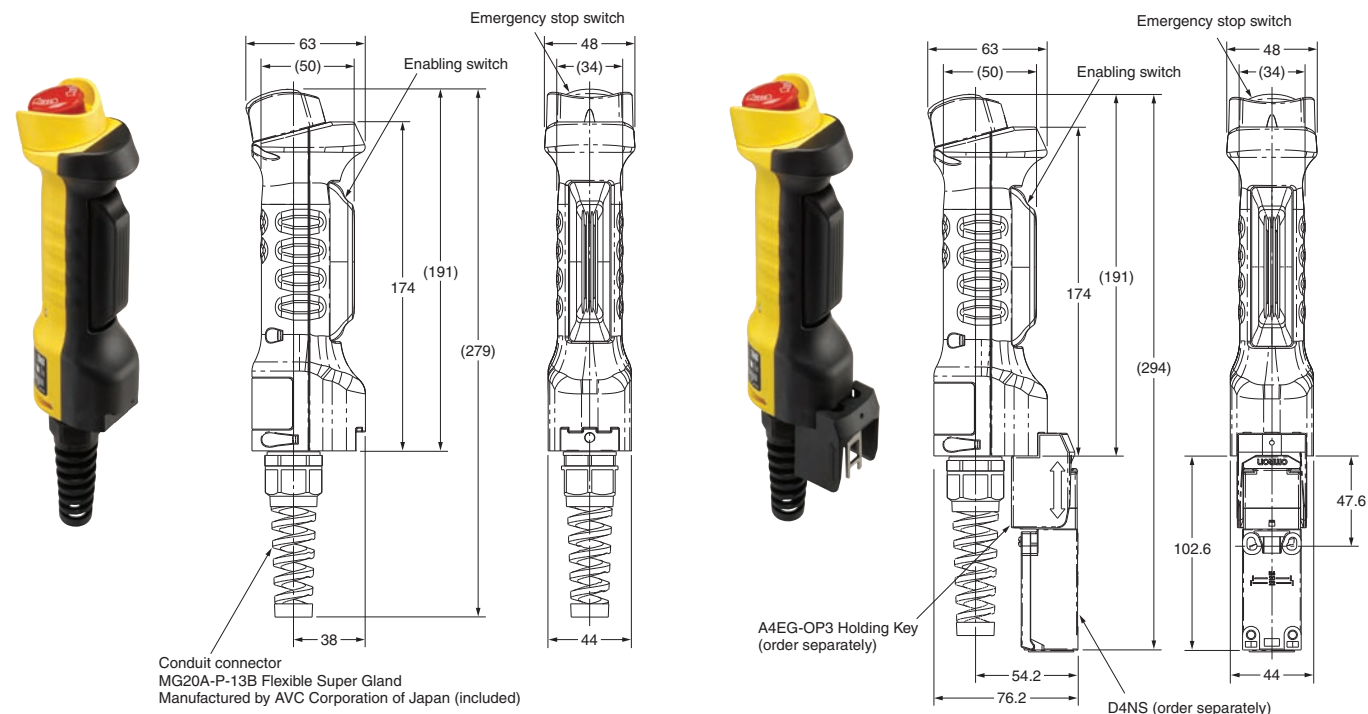

A4EG-BM2B041

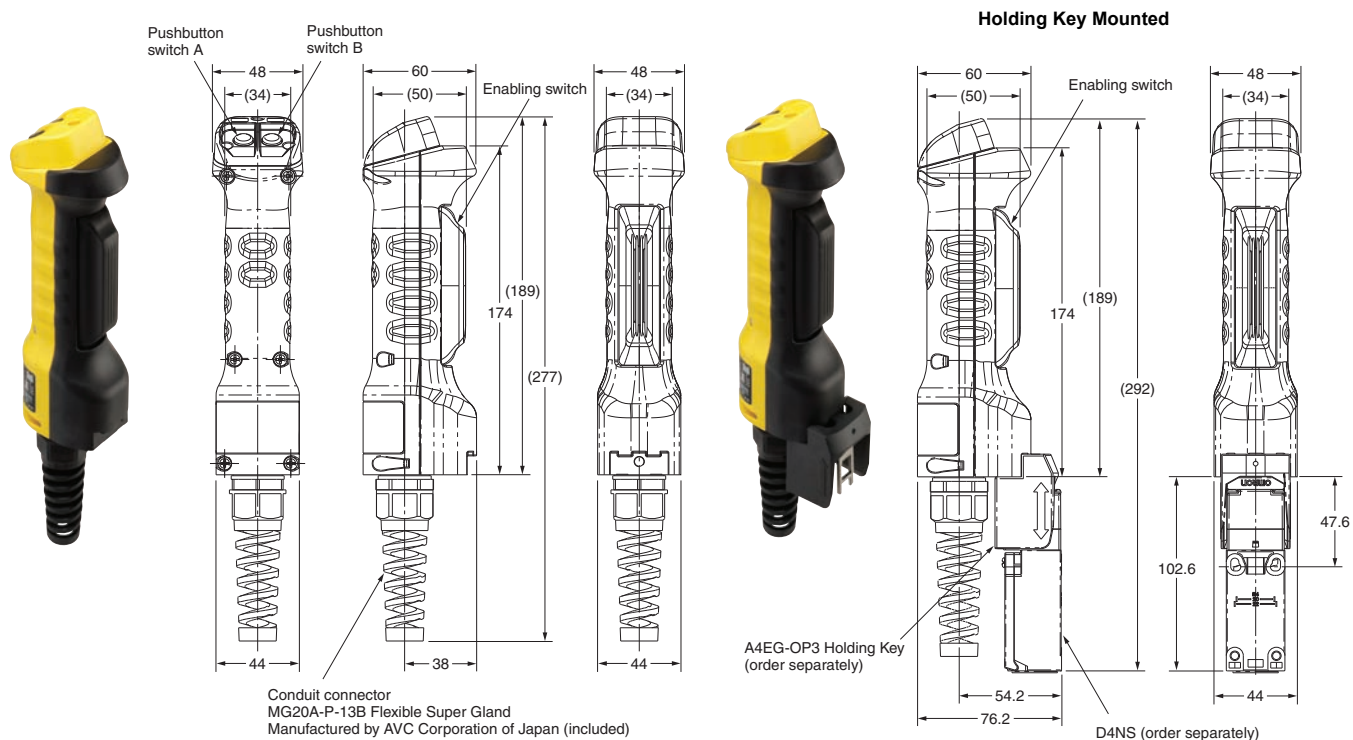

Accessories (Order Separately)

Rubber Cover (Replacement Part)
A4EG-OP1



Mounting Bracket (for Securing the A4EG)
A4EG-OP2

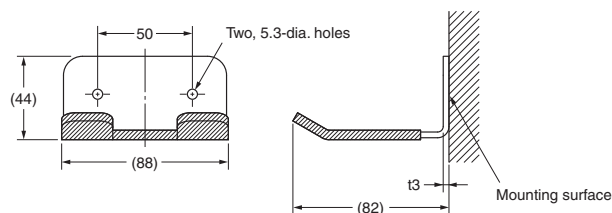

Holding Key
A4EG-OP3



Enabling Grip Switch Mounted

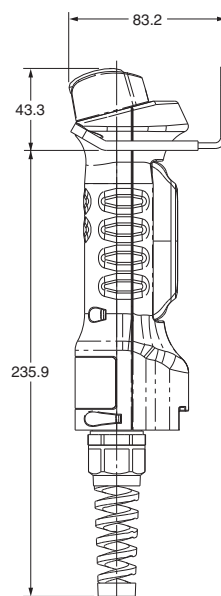

Note: The screws are not included.

Application Examples

Highest achievable PL/ safety category	Model	Stop category	Reset
PLe/4 equivalent	A22TK-□-11-□□ Safety Key Selector Switch D4NL / D4SL-N / D4JL Guard Lock Safety-door Switch (Mechanical Lock Type) D4N / D4F Safety Limit Switch A4EG Enabling Grip Switch G9SX-GS226-T15 Safety Guard Switching Unit G9SX-BC202 Flexible Safety Unit	0	Manual

Note: The above PL is only the evaluation result of the example. The PL must be evaluated in an actual application by the customer after confirming the usage conditions.

Application Overview

1. When the emergency stop switch S1 is pressed.

- The power supply to the motor M1 and M2 is turned OFF immediately when the emergency stop switch S1 is pressed.
- The power supply to the motor M1 is kept OFF until the reset switch S2 is pressed while the emergency stop switch S1 is released.
- When normal operating mode (M1 = ON, M2 = OFF) is selected on the selector switch S8, the power supply to the motor M2 is kept OFF until the guard is closed and the reset switch S2 and S7 are pressed while the emergency stop switch S1 is released.
- When maintenance mode (M1 = OFF, M2 = ON) is selected on the selector switch S8, the power supply to the motor M2 is kept OFF until the enabling switch is gripped to the middle position and the reset switch S2 and S7 are pressed while the emergency stop switch S1 is released.

2. Normal operating mode (the emergency stop switch S1 is released)

- Normal operating mode (M1 = ON, M2 = OFF) is selected on the selector switch S8. The enabling switch S3 is disabled.
- Power is supplied to motor M2 when the guard is closed.
- After opening of the guard is permitted by turning ON of the lock release enable signal, the lock release switch S5 is pressed, then the guard lock is released and the guard is opened. Opening of the guard is detected by S4 and S6, and the power supply to the motor M2 is turned OFF immediately (The power supply to the motor M1 is kept ON).
- The power supply to the motor M2 is kept OFF until the guard is closed and the reset switch S7 is pressed.

3. Maintenance mode (the emergency stop switch S1 is released)

- Maintenance mode (M1 = OFF, M2 = ON) is selected on the selector switch S8 after the motor M2 is stopped. S4 and S6 for detecting the opening and closing of the guard are disabled.
- After opening of the guard is permitted by turning ON of the lock release enable signal, the lock release switch S5 is pressed, then the guard lock is released and the guard is opened.
- The power supply to the motor M2 is turned ON while the enabling switch is gripped to the middle position.
- If the enabling switch is released or gripped past the middle position, the power supply to the motor M2 is turned OFF immediately.
- The power supply to the motor M2 is kept OFF until the enabling switch is gripped again to the middle position and the reset switch S7 is pressed.

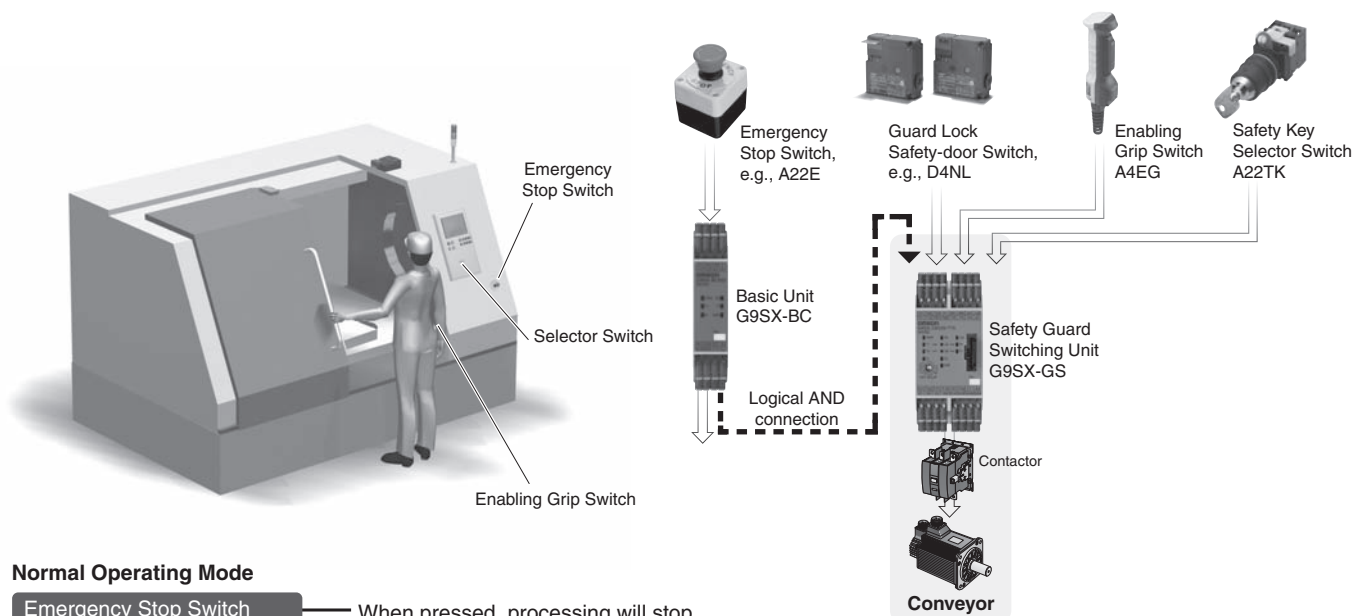

Normal Operating Mode

- Emergency Stop Switch** — When pressed, processing will stop.
- Door** — When the door is opened, processing will stop.
- Enabling Grip Switch** — The Enabling Grip Switch will be disabled.

Maintenance Mode

- Emergency Stop Switch** — When pressed, processing will stop.
- Door** — The Door Switch will be disabled.
- Enabling Grip Switch** — Processing will be possible only when the operator is gripping the Enabling Grip Switch.

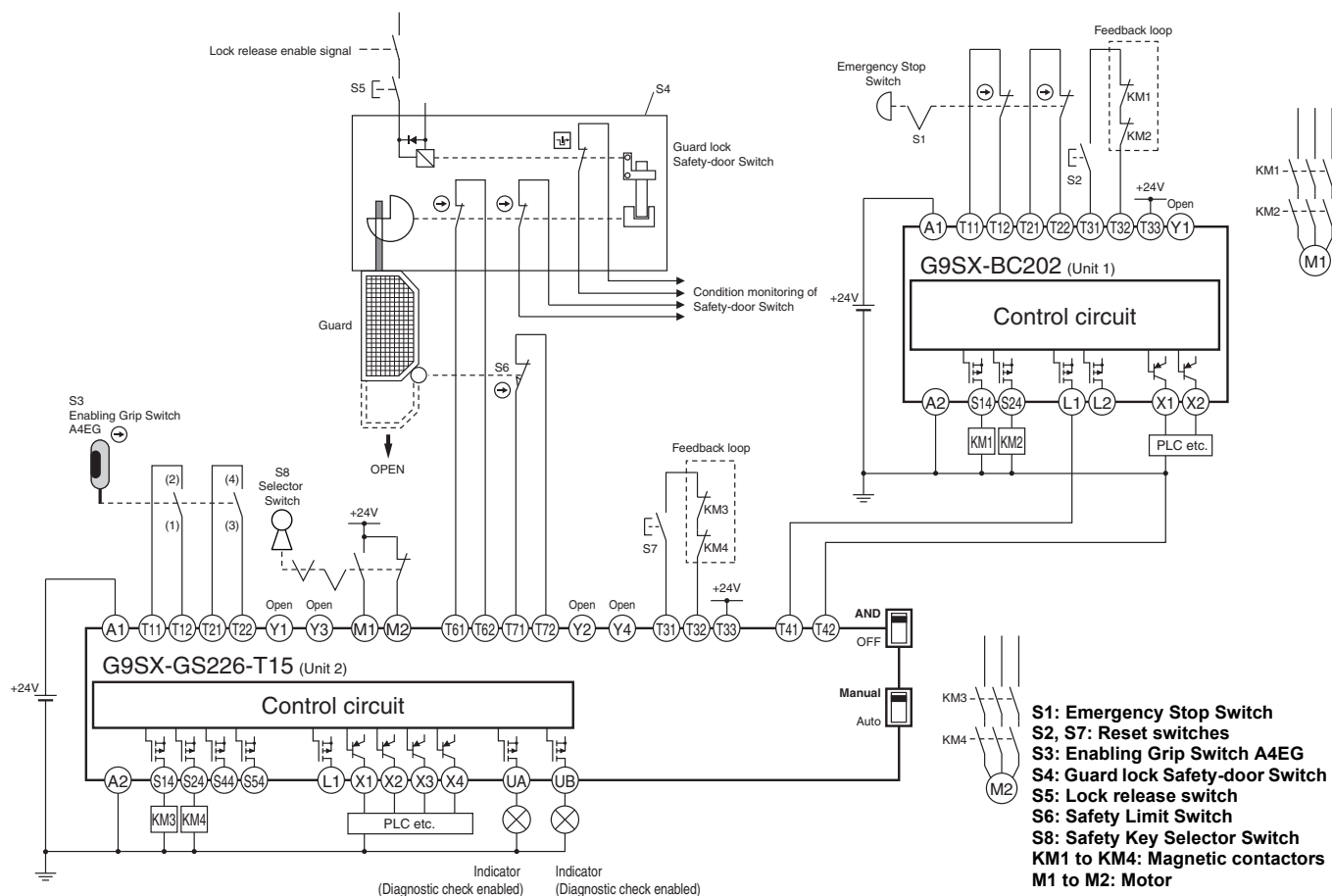

- S1: Emergency Stop Switch
- S2, S7: Reset switches
- S3: Enabling Grip Switch A4EG
- S4: Guard lock Safety-door Switch
- S5: Lock release switch
- S6: Safety Limit Switch
- S8: Safety Key Selector Switch
- KM1 to KM4: Magnetic contactors
- M1 to M2: Motor

Timing Chart

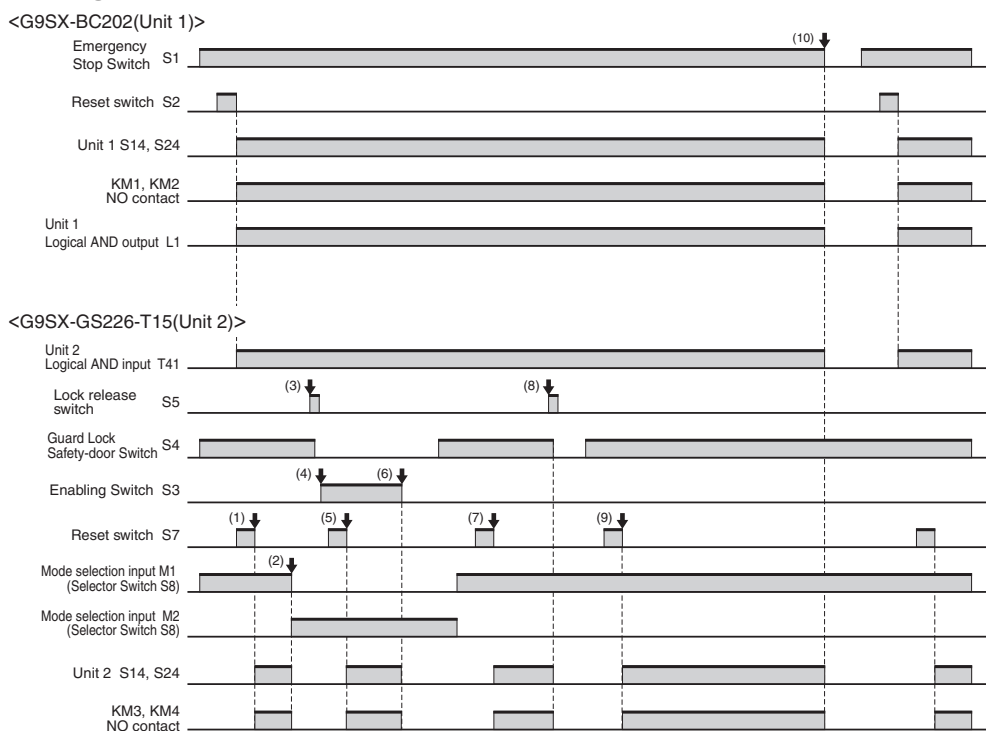

Note: The lock release enable signal must be configured so that it should turn ON after dangerous movement is stopped and safety is ensured for the door to open.

- (1) Start the unit 2 in normal operating mode.
- (2) Switch to maintenance mode by operating the selector switch.
- (3) After checking that the motor has stopped, press the lock release switch to release the guard lock, and open the door to perform maintenance.
- (4) Grip the enabling switch to the middle position.
- (5) Press the reset switch to start the unit 2 in maintenance mode.
- (6) Release (or grip) the enabling switch to stop the unit 2.
- (7) After closing the guard and switching to operating mode by operating the selector switch, press the reset switch to restart the unit 2.
- (8) After checking that the motor has stopped after a stop signal is input during operating mode, press the lock release switch and open the guard to stop the unit 2.
- (9) Close the guard and press the reset switch to restart the unit 2.
- (10) Operate the emergency stop switch -> All the units stop.

Safety Precautions

Indication and Meaning for Safe Use

 WARNING	Indicates a potentially hazardous situation which, if not avoided, will result in minor or moderate injury, or may result in serious injury or death. Additionally there may be significant property damage.
Precautions for Safe Use	Supplementary comments on what to do or avoid doing, to use the product safely.
Precautions for Correct Use	Supplementary comments on what to do or avoid doing, to prevent failure to operate, or undesirable effect on product performance.

WARNING

Always verify the operation of the safety functions before starting the system. Not doing so may result in the safety functions not performing as expected if the wiring or settings are incorrect or the switches have failed.



Do not drop the switch. Doing so may damage the switch and the system may continue to operate, possibly causing injury or death.



Precautions for Safe Use

- This product is a switch for teaching the machine such as robot in hazardous area. The machine is allowed to operate only when operating the switch continuously. Configure the system so that the machine can be operated only at position 2.
- Apply load current not to exceed the rated value.
- Do not use the switch submerged in oil or water or in locations continuously subject to splashes of oil or water. Doing so may result in oil or water entering the switch.
- Do not use the switch in locations where explosive or flammable gasses may be present.
- Mount the switch securely to prevent it from falling. Otherwise, injuries may occur.
- The durability of the switch is greatly influenced by the switching conditions. Always test the switch under actual conditions before application and use it in a switching circuit for which there are no problems with performance.
- Always attach the cover after completing wiring and before using the switch. Electric shock may occur if the switch is used without the cover attached.
- The user must not maintain or repair equipment incorporating the switch. Contact the manufacturer of the equipment for any maintenance or repairs required.
- Do not disassemble or remodel the switch in any case, or the switch will not operate normally.
- Do not override by inserting the Holding Key itself in the door switch.
- Configure the circuit so that the machine does not operate when operating the Enabling Grip Switch while the Holding Key is being inserted in the door switch.
- Do not impose excessive vibration or shock on the Door Switch while the Holding Key is inserted. Excessive vibration or shock may cause the Switch to fail or break.
- Do not incline and pull the switch body or do not impose shock on the switch body in the directions shown with the arrows in Fig.1. Otherwise, the switch may be damaged and may not operate properly.
- Refer to the *D4NS Safety-door Switch Datasheet and Instruction Sheet* about the storage, ambient conditions, the details and handling of the Switch.

Fig. 1

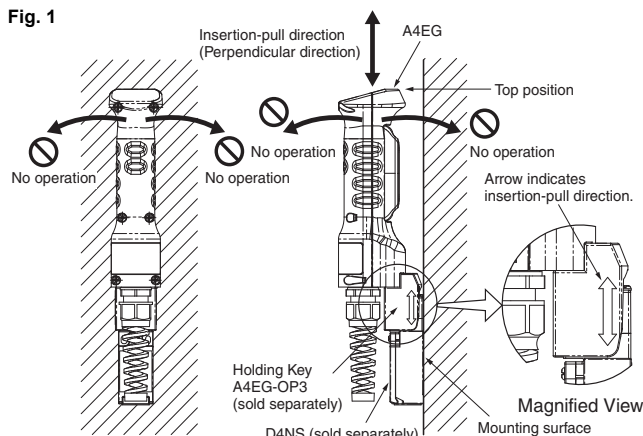

- Do not contact the enabling switch section to the mounting bracket in Fig.2. Doing so may result in malfunction.

Fig. 2

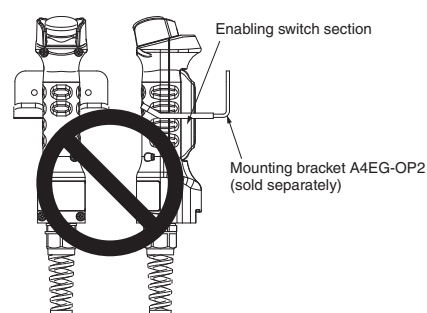

Precautions for Correct Use

- Do not hold the Enabling Grip Switch Device at Position 2 by any other methods except for handling. Otherwise, the original function of the Enabling Grip Switch Device is not worked.

Operating Environment

- This switch is designed for use indoors. Using the switch outdoors may damage it.
- The switch contacts can be used with either standard loads or microloads. Once the contact be used to switch smaller loads. The contact surfaces will become rough once they have been used and contact reliability for smaller loads may be reduced.
- Do not use the switch in the following locations.
 - Locations where the interior of the Protective Door may into direct contact with cutting chips, metal filings, oil chemicals
 - Locations subject to detergents, thinners, or other solvents
 - Locations subject to sudden temperature changes
 - Locations subject to high humidity and condensation
 - Locations subject to severe vibration
- Do not use the switch where corrosive gasses (e.g., H₂S, SO₂, NH₃, HNO₃, or Cl₂) are present or in locations subject to high temperature and humidity. Doing so may result in damage to the switch as a result of contact failure or corrosion.
- Do not store the switch where corrosive gasses (e.g., H₂S, SO₂, NH₃, HNO₃, or Cl₂) or dust are present or in high temperature and humidity.
- If the switch is not turned ON and OFF for a long period of time, contact resistance may be increased or continuity failure may occur due to contact oxidation.

Mounting Method

Specified Tightening Torque

Loose screws may result in malfunction. Be sure to tighten each screw of the Switch properly.

Item	Specified torque
Cover mounting screw	1.1 to 1.3 N·m
Terminal screw	0.4 to 0.5 N·m
Holding Key mounting screw	0.5 to 0.7 N·m
Conduit Connector (Conforming spanner 27 mm (width across flats))	2.0 to 2.4 N·m
Mounting Bracket	2.4 to 2.8 N·m

Cover Mounting

- Dislocation of the seal rubber or foreign substance on the seal rubber reduces seal performance of the switch. Mount the cover after confirming that there is no abnormality on the seal rubber. If the seal rubber cracks or breaks, replace the Cover with a new one (A4EG-OP1 Rubber Cover, separately sold).
- Do not touch the rubber boot with sharp objects. Otherwise, the rubber boot may break and the operating characteristics and the seal performance may not be satisfied.

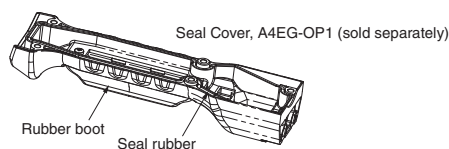

Installing Mounting Bracket

- Securely install the Mounting Bracket using M5 screws and washers and tighten them to a torque of 2.4 to 2.8 N·m.

Holding Key Type (sold separately)

- Use the A4EG-OP3 Holding Key when using the A4EG combining with the door switch.
- Use the D4NS Safety-door Switch.
- Loose screws may result in malfunction. Tighten the screws at the specified torques. Adhesive is recommended to prevent screws from being loose.
The specified torque: 0.5 to 0.7 N·m (Mounting screw, 2 pcs.)
- Do not impose excessive force on the tip of the Holding Key or do not drop the switch body when the Holding Key is mounted on the switch body. Otherwise the Holding Key may deform or break. Stop using in case that deformation or breakage of the Holding Key occurs.
- Use the provide Spring washers and Mounting screws when mounting the Holding Key. Fit a tip of a slotted-screw driver on the head of the Mounting screw as shown in the following figure when tightening Mounting screws. The Mounting screws cannot be released once tightened.

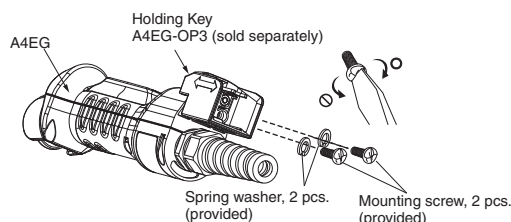

- As shown in figure 1 in *Precautions for Safe Use*, install the D4NS so that its mounting surface is above the highest part of the A4EG.
- As shown in figure 1 in the *Precautions for Safe Use*, use the Holding Key inserted vertically to the insert hole.

Using the A4EG-BE2R041 (Enabling Grip Switch Equipped with an Emergency Stop Button)

If the A4EG is installed in a machine, do not use the A4EG alone as an emergency stop switch or as an emergency shutoff switch as specified by SEMI-S2.

SEMI-S2 specifies the installation of emergency shutoff switches at

specified intervals on equipment. The A4EG can be removed from the equipment, and so may not satisfy the requirements of SEMI. Use the A4EG in combination with emergency stop switches or emergency shutoff switches that are installed at fixed positions.

Wiring

- Confirm that safety is satisfied on the operation of the equipment to wire.
- Do not put the electric power when wiring. Otherwise electric shock may occur.
- Use an adequate diameter of cable. The seal performance is reduced when the diameter is smaller than the adequate diameter.
- Use the conforming sizes of lead wires to the apply voltage and current.

Conforming cable size

Recommended multi-wire cable size: AWG20 to 18

(0.5 to 0.75 mm²)

Recommended cable diameter:

8.0 to 13 mm

(used with provided Conduit Connector)

- Do not pull the lead wires with excessive force. Doing so may disconnect them.
- Do not pull the cable when the Enabling Switch Device is hung on the Bracket.

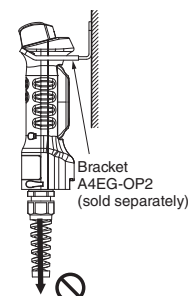

- Use crimp terminals with insulator tube for wiring.
Recommended crimp terminal (Ring tongue terminal, Nylon-insulated): J.S.T. Mfg Co. FN1.25-3.7 (F Type)/N1.25-3.7 (Straight Type)

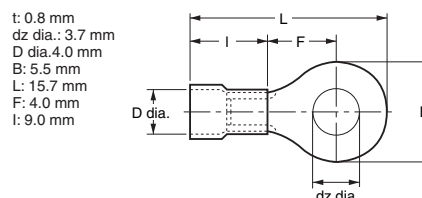

- Cut and crimp the lead wires in length as shown in the following table.
Otherwise, excess length may cause the cover to rise and not fit properly.

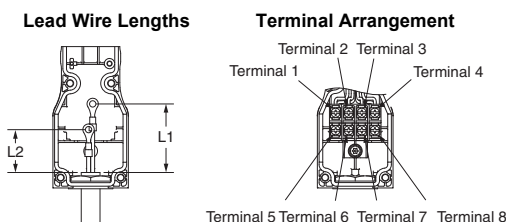

Length of lead wires	Terminal No.	1-4	5-8
L1/L2 (Length to the centers of crimp terminals)		40±2 mm	25±2 mm

- Do not let particles such as small piece of lead wire in the switch body when wiring.

Terminal No. and Circuit Configuration

Model	Circuit	Terminal No.
A4EG-C000041	Enable output	1-2, 3-4
	Grip output	5-6
A4EG-BE2R041	Enable output	1-2, 3-4
	Emergency Stop Pushbutton Switch output	5-6, 7-8
A4EG-BM2B041	Enable output	1-2, 3-4
	Pushbutton Switch output	5-6, 7-8

- Assemble all of the parts without leaving any parts as shown in the following figure when mounting Conduit Connector. Mount Rubber packing, Conduit part, Cable Seal part and Spiral Nut part in order.

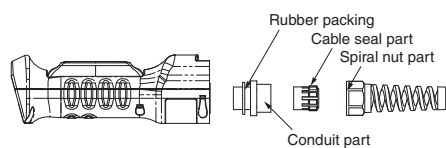

- Both of the switches is ON when pushing the two push buttons simultaneously. Confirm that safety is satisfied on the operation of the equipment to wire. (A4EG-BM2B041)
- Perform maintenance inspections periodically.

Terms and Conditions Agreement

Read and understand this catalog.

Please read and understand this catalog before purchasing the products. Please consult your OMRON representative if you have any questions or comments.

Warranties.

(a) Exclusive Warranty. Omron's exclusive warranty is that the Products will be free from defects in materials and workmanship for a period of twelve months from the date of sale by Omron (or such other period expressed in writing by Omron). Omron disclaims all other warranties, express or implied.

(b) Limitations. OMRON MAKES NO WARRANTY OR REPRESENTATION, EXPRESS OR IMPLIED, ABOUT NON-INFRINGEMENT, MERCHANTABILITY OR FITNESS FOR A PARTICULAR PURPOSE OF THE PRODUCTS. BUYER ACKNOWLEDGES THAT IT ALONE HAS DETERMINED THAT THE PRODUCTS WILL SUITABLY MEET THE REQUIREMENTS OF THEIR INTENDED USE.

Omron further disclaims all warranties and responsibility of any type for claims or expenses based on infringement by the Products or otherwise of any intellectual property right. (c) Buyer Remedy. Omron's sole obligation hereunder shall be, at Omron's election, to (i) replace (in the form originally shipped with Buyer responsible for labor charges for removal or replacement thereof) the non-complying Product, (ii) repair the non-complying Product, or (iii) repay or credit Buyer an amount equal to the purchase price of the non-complying Product; provided that in no event shall Omron be responsible for warranty, repair, indemnity or any other claims or expenses regarding the Products unless Omron's analysis confirms that the Products were properly handled, stored, installed and maintained and not subject to contamination, abuse, misuse or inappropriate modification. Return of any Products by Buyer must be approved in writing by Omron before shipment. Omron Companies shall not be liable for the suitability or unsuitability or the results from the use of Products in combination with any electrical or electronic components, circuits, system assemblies or any other materials or substances or environments. Any advice, recommendations or information given orally or in writing, are not to be construed as an amendment or addition to the above warranty.

See <http://www.omron.com/global/> or contact your Omron representative for published information.

Limitation on Liability: Etc.

OMRON COMPANIES SHALL NOT BE LIABLE FOR SPECIAL, INDIRECT, INCIDENTAL, OR CONSEQUENTIAL DAMAGES, LOSS OF PROFITS OR PRODUCTION OR COMMERCIAL LOSS IN ANY WAY CONNECTED WITH THE PRODUCTS, WHETHER SUCH CLAIM IS BASED IN CONTRACT, WARRANTY, NEGLIGENCE OR STRICT LIABILITY.

Further, in no event shall liability of Omron Companies exceed the individual price of the Product on which liability is asserted.

Suitability of Use.

Omron Companies shall not be responsible for conformity with any standards, codes or regulations which apply to the combination of the Product in the Buyer's application or use of the Product. At Buyer's request, Omron will provide applicable third party certification documents identifying ratings and limitations of use which apply to the Product. This information by itself is not sufficient for a complete determination of the suitability of the Product in combination with the end product, machine, system, or other application or use. Buyer shall be solely responsible for determining appropriateness of the particular Product with respect to Buyer's application, product or system. Buyer shall take application responsibility in all cases.

NEVER USE THE PRODUCT FOR AN APPLICATION INVOLVING SERIOUS RISK TO LIFE OR PROPERTY OR IN LARGE QUANTITIES WITHOUT ENSURING THAT THE SYSTEM AS A WHOLE HAS BEEN DESIGNED TO ADDRESS THE RISKS, AND THAT THE OMRON PRODUCT(S) IS PROPERLY RATED AND INSTALLED FOR THE INTENDED USE WITHIN THE OVERALL EQUIPMENT OR SYSTEM.

Programmable Products.

Omron Companies shall not be responsible for the user's programming of a programmable Product, or any consequence thereof.

Performance Data.

Data presented in Omron Company websites, catalogs and other materials is provided as a guide for the user in determining suitability and does not constitute a warranty. It may represent the result of Omron's test conditions, and the user must correlate it to actual application requirements. Actual performance is subject to the Omron's Warranty and Limitations of Liability.

Change in Specifications.

Product specifications and accessories may be changed at any time based on improvements and other reasons. It is our practice to change part numbers when published ratings or features are changed, or when significant construction changes are made. However, some specifications of the Product may be changed without any notice. When in doubt, special part numbers may be assigned to fix or establish key specifications for your application. Please consult with your Omron's representative at any time to confirm actual specifications of purchased Product.

Errors and Omissions.

Information presented by Omron Companies has been checked and is believed to be accurate; however, no responsibility is assumed for clerical, typographical or proofreading errors or omissions.