

F3SP-T01

Simplifies wiring from Safety Light Curtains to the Safety Relay outputs.

As of June 2009



- Simplifies wiring inside the panel and helps prevent incorrect wiring.
- Terminals are numbered to make it easy to check terminal connections.
- Replacement of relays is easy, improving maintainability.
- Screw-less clamp terminals eliminate the need for extra tightening.
- The Support Software can be connected, enabling on-site adjustment of Light Curtains.

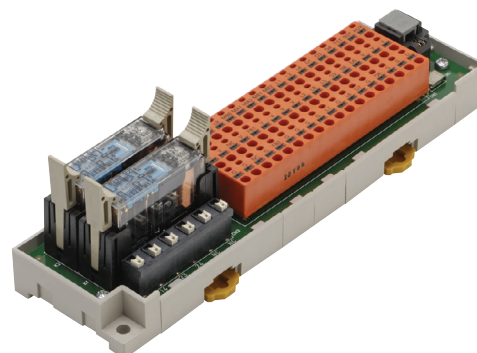

⚠ Be sure to read the "Safety Precautions" on page 8 and the "Precautions for All Safety Sensors".

Ordering Information

Safety Terminal Relays

Type	Applicable models	Model
Safety Terminal Relay	F3SJ-A□□□□P□□	F3SP-T01

Optional Accessories (Sold Separately)

Type	Model
Cable for connecting Support Software (cable length: 1.5 m)	E39-Z12-1
Replacement Relay	G7SA-3A1B

Specifications (Refer to Instruction Manual for details.)

Ratings

Power supply

Rated voltage	24 VDC+10%/–15%
Rated power consumption	DC 1.7 W max. (not including sensor's power consumption)

Contacts

Rated load	250 VAC 3 A, resistive load 30 VDC 3 A, resistive load
Rated current	3 A
Applicable Relays	G7SA-3A1B: 24 VDC

Characteristics

Operation time	100 ms max. (not including sensor's response time)
Response time	10 ms max. (not including sensor's response time)
Vibration resistance	10 to 55 to 10 Hz Single amplitude: 0.35 mm (Double amplitude: 0.7 mm)
Shock resistance	Destruction: 300 m/s ² , Malfunction: 100 m/s ²
Ambient operating temperature	–10 to 55°C
Ambient operating humidity	35 to 85%
Weight	Approx. 215 g

Durability

Electrical durability	100,000 operations min. Rated load Switching frequency: 1,800 operations/h
Mechanical durability	5,000,000 operations min. Switching frequency: 7,200 operations/h

Connections

Internal Circuit Diagrams

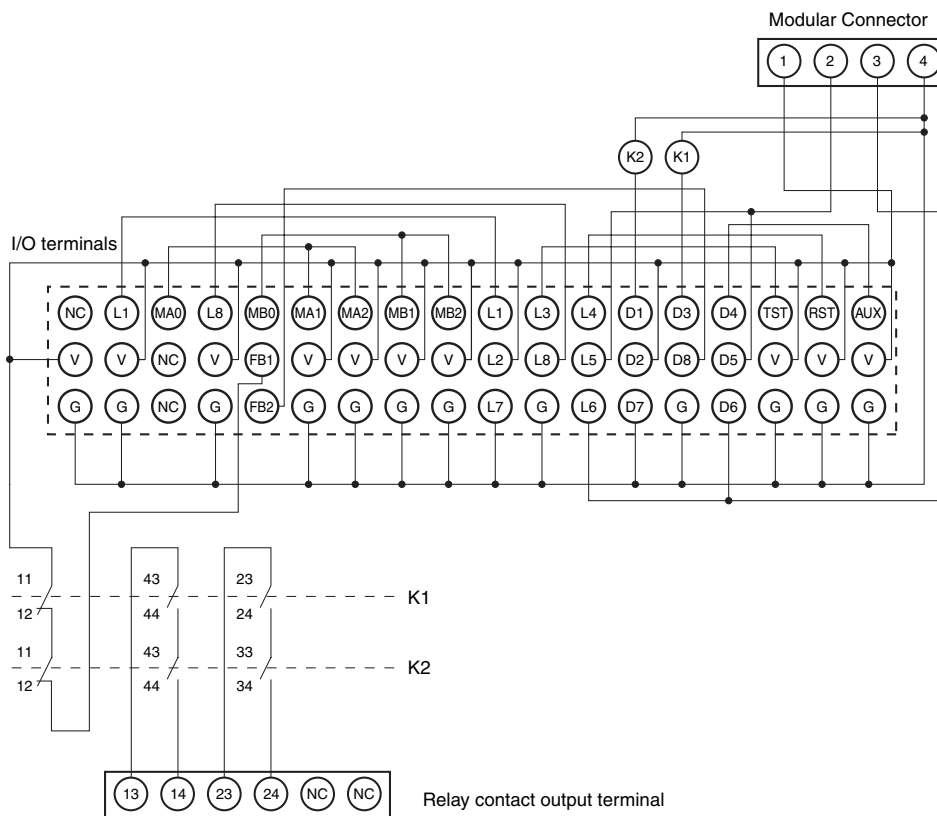

Wiring Diagrams

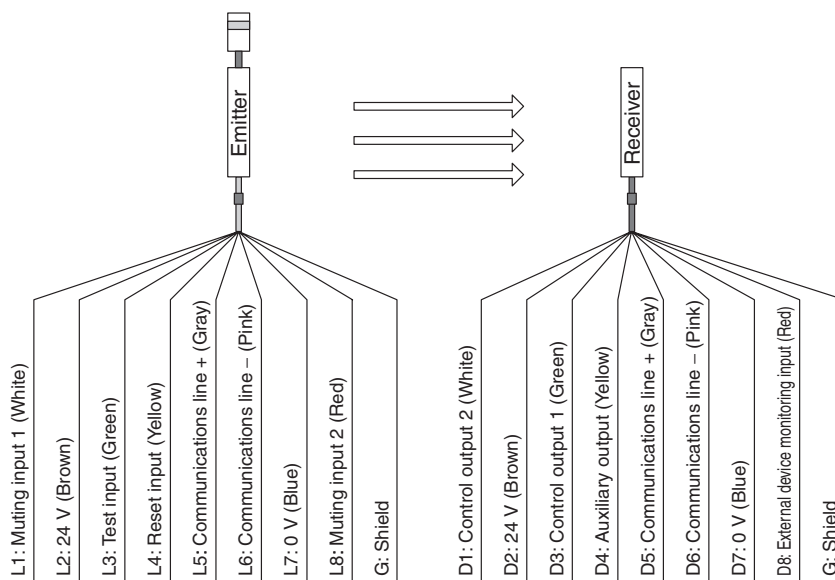

Wiring Example

The following example is for when two muting sensors are connected in the auto reset mode, and the external device monitoring function is enabled.

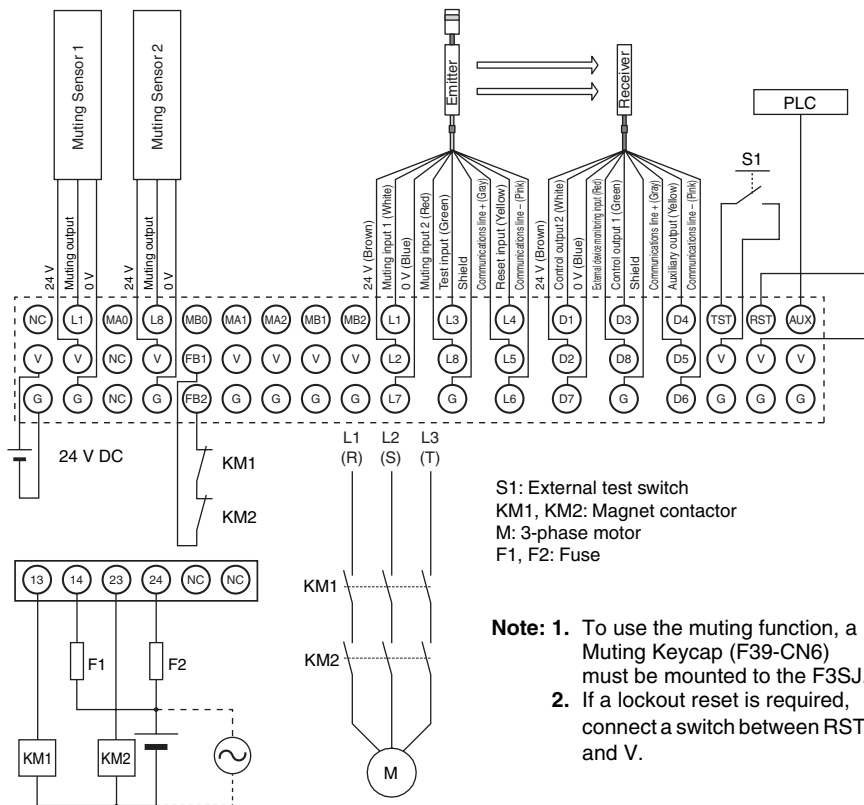

Connecting Four Muting Sensors

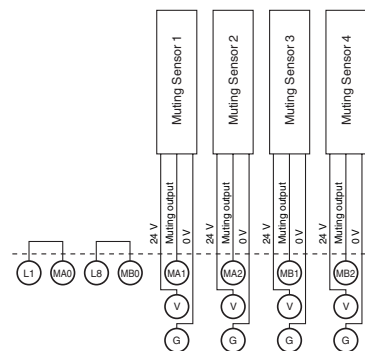

Note: If you are connecting four muting sensors, connect the sensor outputs to MA1, MA2, MB1, and MB2. Also short-circuit MA0 to L1, and MB0 to L8.

The following example is for when two muting sensors are connected in auto reset mode, and the external device monitoring function is disabled.

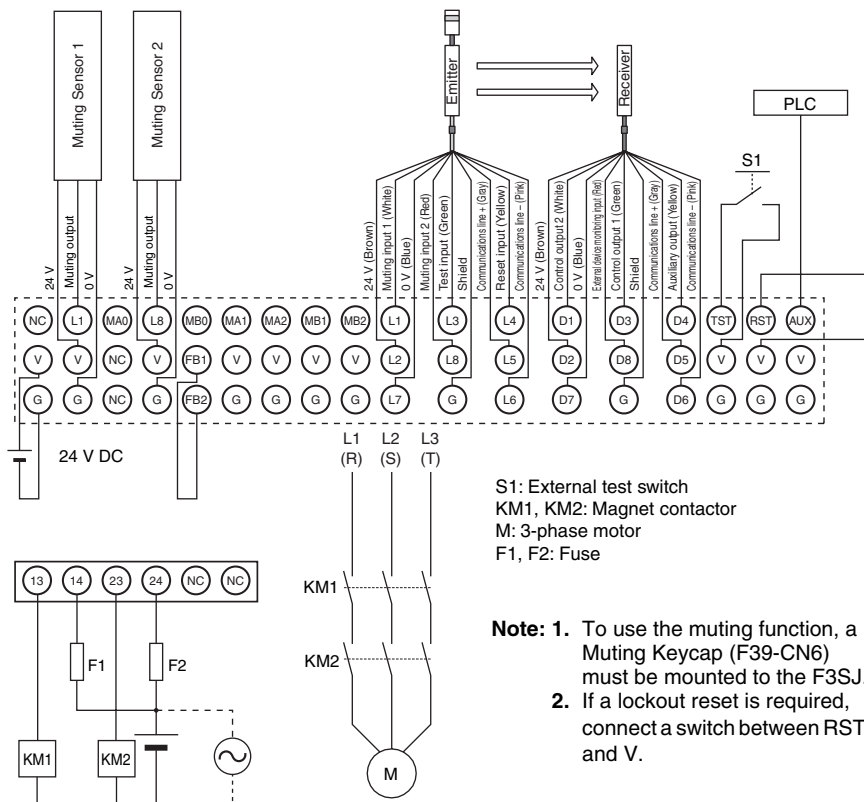

Connecting Four Muting Sensors

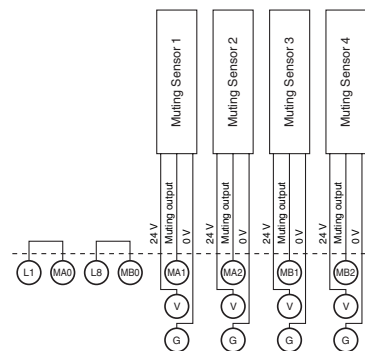

Note: If you are connecting four muting sensors, connect the sensor outputs to MA1, MA2, MB1, and MB2. Also short-circuit MA0 to L1, and MB0 to L8.

The following example is for when no muting sensors are connected in the auto reset mode, and the external device monitoring function is enabled.

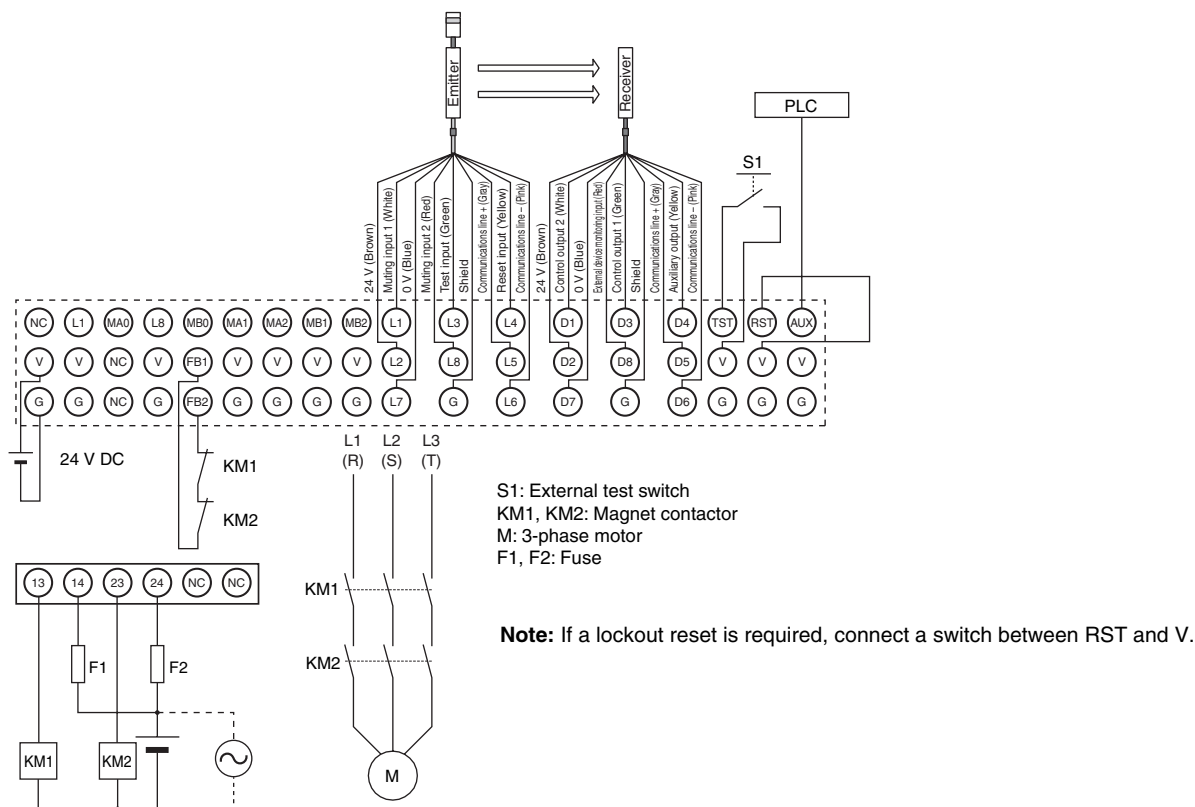

The following example is for when no muting sensors are connected in the auto reset mode, and the external device monitoring function is disabled.

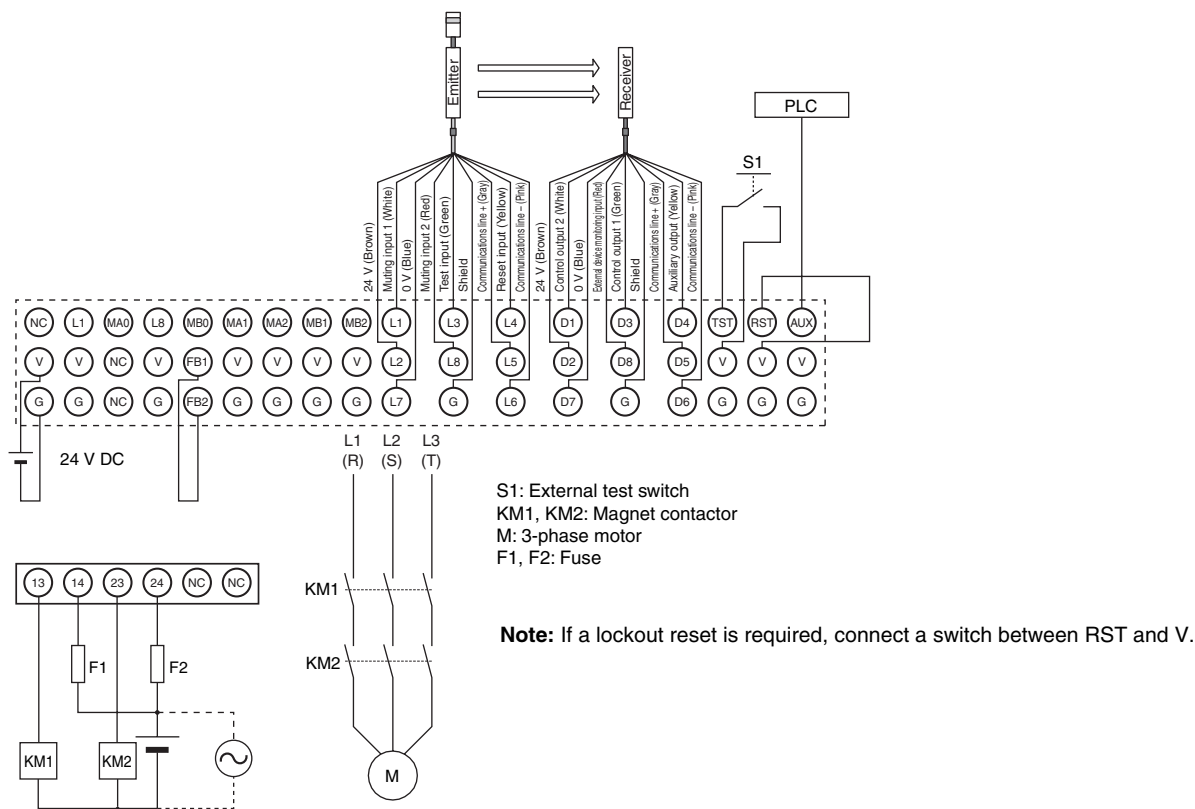

The following example is for when two muting sensors are connected in the manual reset mode, and the external device monitoring function is enabled.

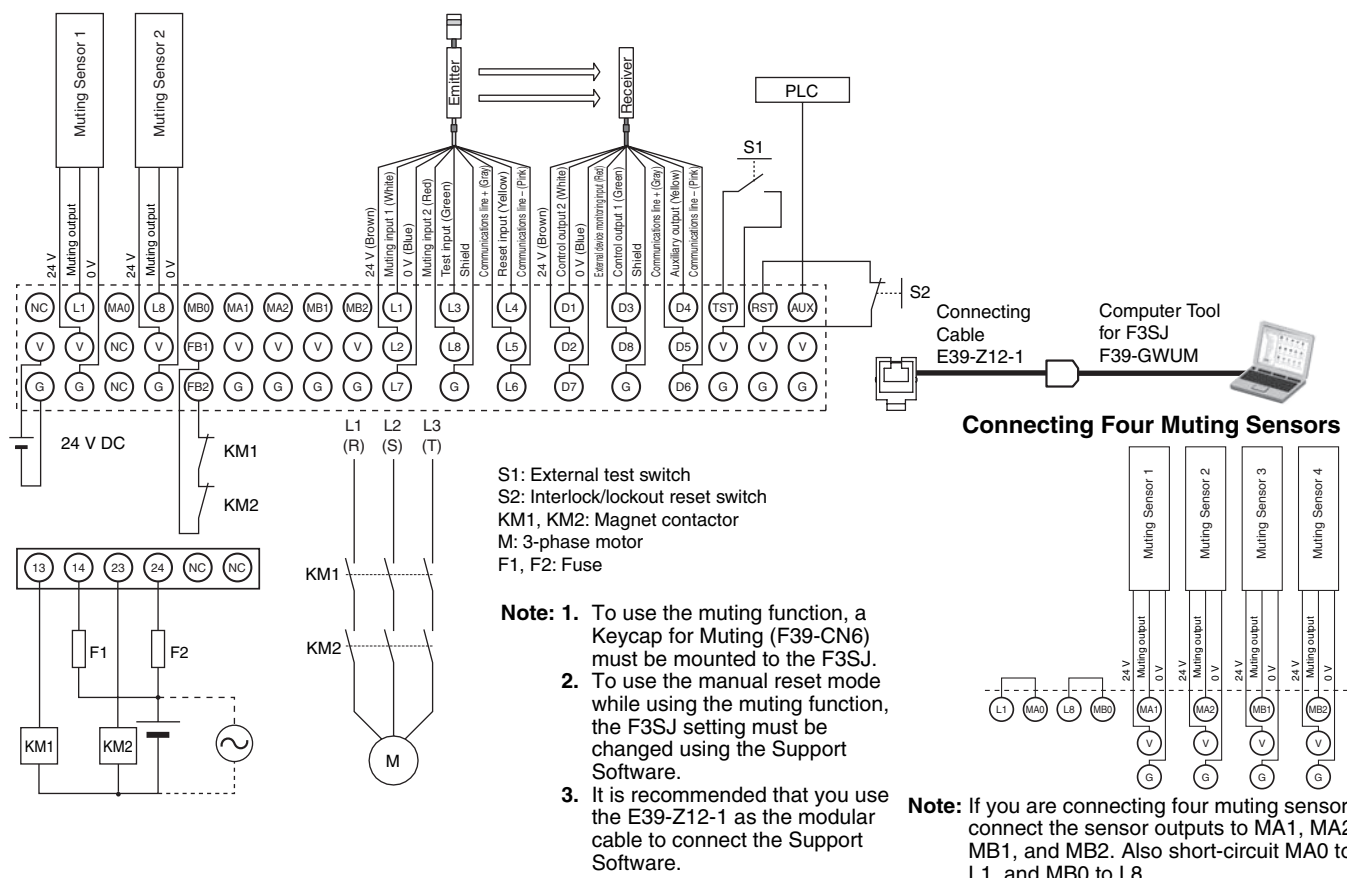

The following example is for when two muting sensors are connected in manual reset mode, and the external device monitoring function is disabled.

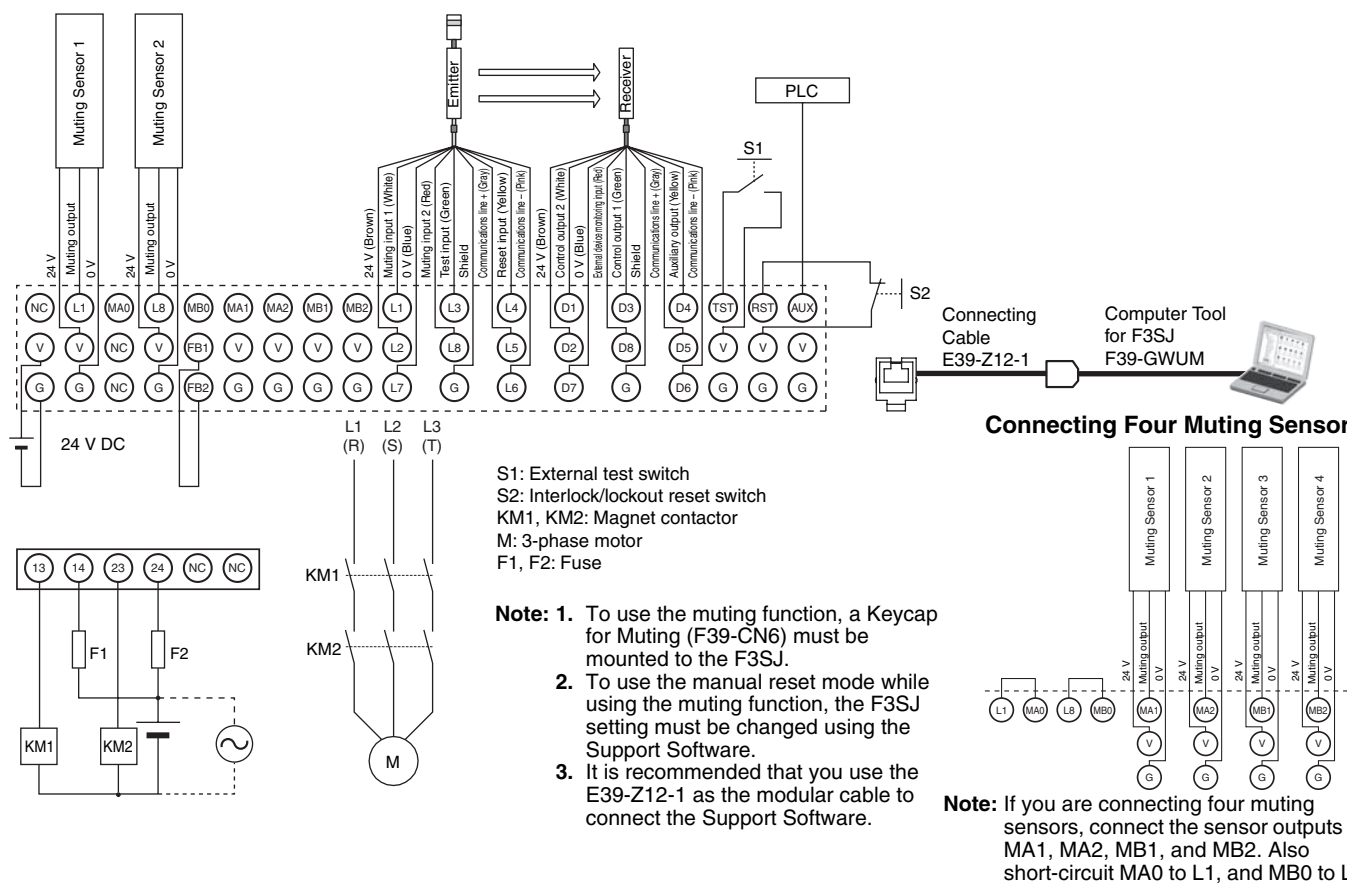

The following example is for when no muting sensors are connected in the manual reset mode, and the external device monitoring function is enabled.

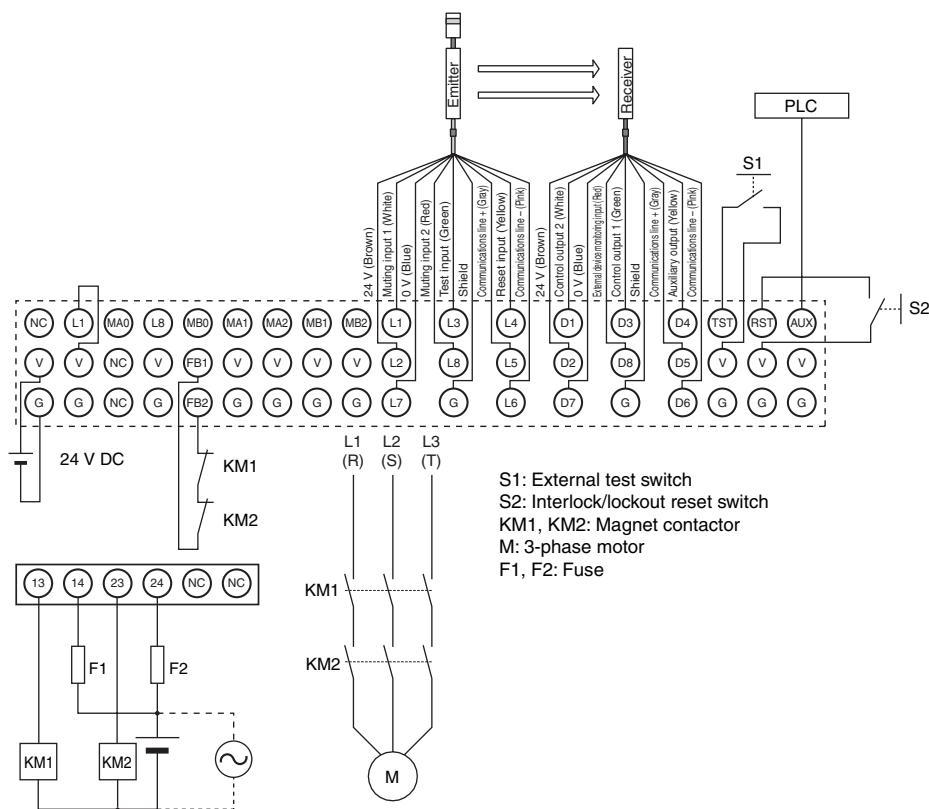

The following example is for when no muting sensors are connected in the manual rest mode, and the external device monitoring function is disabled.

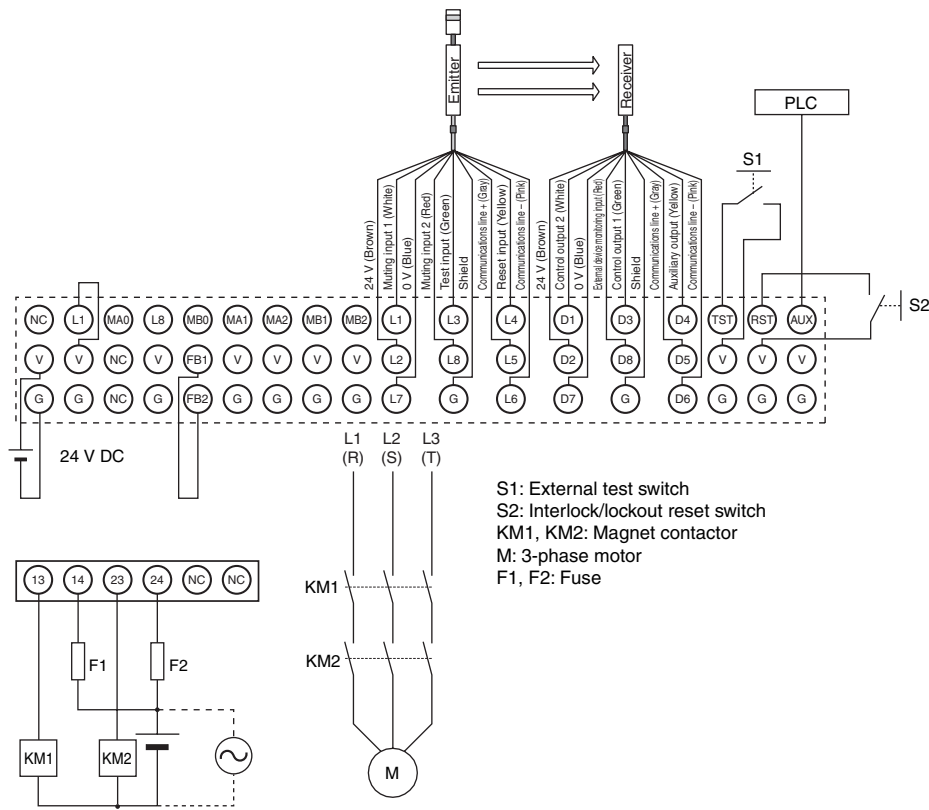

Dimensions

(Unit: mm)

F3SP-T01

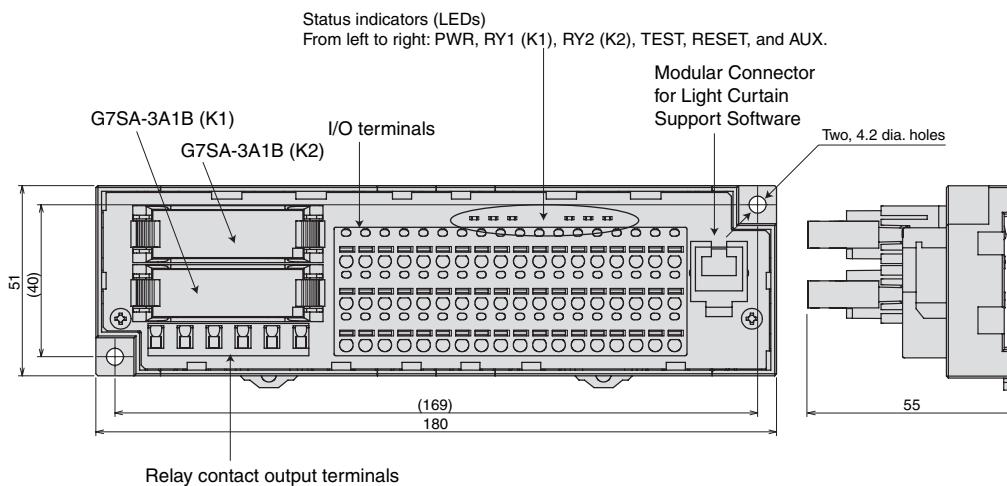

Safety Precautions

⚠ WARNING

Do not operate the product in atmospheres containing flammable or explosive gas. Arcs or heating of relays during switching may cause fire or explosion.



Do not use a load that exceeds the contact ratings or switching capacity. Doing so may cause the product to fail to perform its specified functions, causing insulation failure, contact welding, or contact failure. It may also cause damage to the F3SP-T01 or burning.



The service life will depend on the switching conditions. Be sure to check the actual operating conditions using the actual devices, and make sure that the number of switching operations will not cause performance problems. If you continue to use the device with deteriorated performance, it may result in breakdown of insulation between circuits, or cause burning of the product.



Precautions for Safe Use

Handle with Care

Do not drop the product or expose it to excessive vibration or shock. Doing so may prevent it from functioning properly.

Adhesion of Solvent

Do not allow solvents, such as alcohol, thinner, trichloroethane, or gasoline, to come into contact with the product. Such solvents may make the markings illegible and cause deterioration of parts.

Installation Location

Do not install or store the product in the following locations. Doing so may result in product failure or malfunction.

- Locations subject to direct sunlight
 - Locations subject to temperatures outside the range -10 to 55°C
 - Locations subject to humidity levels outside the range 35% to 85%
 - Locations subject to condensation due to extreme temperature changes
 - Locations subject to atmospheric pressures outside the range 86 to 106 kPa
 - Locations subject to corrosive or flammable gases
 - Locations subject to shock or vibration in excess of the product ratings
 - Locations subject to exposure to water, oil, or chemicals
 - Locations subject to dust (including iron dust) or salts
- Take appropriate and sufficient countermeasures when using the product in the following locations.
- Locations subject to static electricity or other forms of noise
 - Locations subject to possible exposure to radioactivity
 - Locations close to power supply lines

Installation

- Do not use products that have been dropped or have its internal parts disassembled. Specified characteristics may not be achieved, and may cause damage to the product or burning.
- If the products are installed side-by-side, the rated current is 1 A. Do not exceed 1 A.
- Use the F3SP-T01 in an enclosure that provides at least IP54 degree of protection.

Installation and Wiring

- Use the following electrical wiring for external I/O devices.

Solid wire	0.2 to 1.3 mm ² AWG24 to 16
Flexible wires	1.3 to 2.0 mm ² , AWG16 to 14 If flexible wires are used, terminate the wires with insulated ferrules (DIN 46228-4 compatible type) before connecting them.

Compatible Ferrules

- Use ferrules that meet the following standards for length and width. If the standards are not met, connection may fail, or the ferrules may not be able to be plugged in and out of the terminals.
- Ferrule Dimensions (for Power Supply Terminal of F3SP-T01)

Square Ferrules

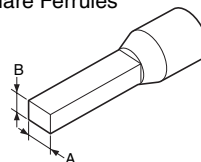

Cylindrical Ferrules

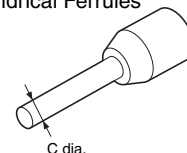

Square Ferrules	Dimension A	1.0 to 2.3	The cross-sectional area after crimping must be less than 4.8 mm ² .
	Dimension B	0.8 to 2.65	
Cylindrical Ferrules	Dimension C	0.8 dia. to 2.3 dia.	

- Recommended Ferrule and Crimping Tool

Type of ferrule	Manufacturer	Size	Model	Recommended crimping tool
Square Ferrules	Phoenix Contact	AWG24	AI0.25-8YE	UD6 ZA3
		AWG22	AI0.34-8TQ	
		AWG20	AI0.5-10WH AI0.5-8WH	
		AWG18	AI0.75-10GY AI0.75-8GY	
		AWG16	AI1.5-10BK	
		AWG14	AI2.5-10BU	
	Weidmuller	AWG24	H0.25/12	PZ6 roto
		AWG22	H0.34/12	
		AWG20	H0.5/16 H0.5/14	
		AWG18	H0.75/16 H0.75/14	
Cylindrical Ferrules	Nichifu	AWG22	TGV TC-1.25-11T TGN TC-1.25-11T	NH11 NH32 NH65
		AWG20		
		AWG18		
		AWG16		

- Apply the specified voltages to the input terminals. Applying an inappropriate voltage may prevent specified functions from operating properly, which may cause damage to the product or burning.
- Disconnect the power supply before wiring.
- Check the condition of the emitter and receiver before connecting them.
- You cannot use the product if the positive side is connected to ground.
- NC terminals have no function. Do not connect them.

Wiring the Terminal Block

- Insert the wires using the following procedure.
Flexible wires: (1) Use a flat-blade screwdriver to push in the lever and (2) insert the wire.
Solid wires or ferrules: Insert the wire into the wire hole and push all the way to the back. (Operating the lever is not required.)
- Remove the wires using the following procedure (same for flexible wires, solid wires, and ferrules).
(1) Use a flat-blade screwdriver to push in the lever and (3) pull out the wire.

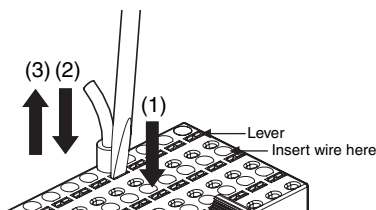

- Use a flat-blade screwdriver that has the same thickness from tip to base and is within the following standards.

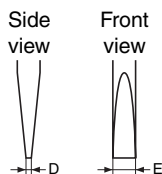

Dimension D	0.3 to 0.8
Dimension E	2.9 to 3.6

We recommend the following flat-blade screwdrivers for inserting wires.

Recommended Screwdrivers

Model
XW4Z-00B
XW4Z-00C

Mounting to and Removing from DIN Track

- To mount the product to a DIN Track, release the slider lock, place the product on the DIN track, and then lock the slider.
- After using the slider lock, make sure that the lock is engaged on the DIN Track.
- To dismount the product from the DIN Track, place the driver in the slider section, release the lock, and then remove the product from the DIN Track.
- Secure both ends of the Safety Terminal Relays with End Plates. The following products are sold separately.

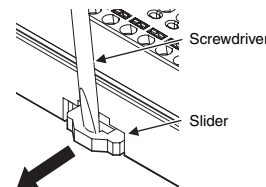

DIN Tracks	PFP-50N PFP-100N
End Plate	PFP-M

Selecting the Power Supply

- Use the rated power supply voltage. Do not use power supplies with large ripple component or intermittent irregular voltages.
- To meet IEC 61496-1 and UL 508 safety standards and to prevent electrical shock, make sure that the power supply and load satisfy the requirements outlined in the sensor's user manual.

Periodic Checks and Maintenance

- Do not attempt to disassemble, repair, or modify the product.
- Make sure that the power supply is turned OFF before replacing parts.

Disposal

- Exercise caution to prevent injury when disassembling the F3SP-T01.

Precautions for Correct Use

Durability of Contact Outputs

The durability of the contact outputs on Safety Terminal Relays varies considerably depending on switching conditions. Always confirm the usage conditions by testing the Safety Terminal Relay in an actual application, and use the Safety Terminal Relay only for the number of switching operations that its performance allows. Restarting may not be possible if the switching capacity is exceeded. If this occurs, replace the relevant relays immediately. If a Safety Terminal Relay is used after performance has deteriorated, it may result in reduced safety.

Read and Understand This Catalog

Please read and understand this catalog before purchasing the products. Please consult your OMRON representative if you have any questions or comments.

Warranty and Limitations of Liability

WARRANTY

OMRON's exclusive warranty is that the products are free from defects in materials and workmanship for a period of one year (or other period if specified) from date of sale by OMRON.

OMRON MAKES NO WARRANTY OR REPRESENTATION, EXPRESS OR IMPLIED, REGARDING NON-INFRINGEMENT, MERCHANTABILITY, OR FITNESS FOR PARTICULAR PURPOSE OF THE PRODUCTS. ANY BUYER OR USER ACKNOWLEDGES THAT THE BUYER OR USER ALONE HAS DETERMINED THAT THE PRODUCTS WILL SUITABLY MEET THE REQUIREMENTS OF THEIR INTENDED USE. OMRON DISCLAIMS ALL OTHER WARRANTIES, EXPRESS OR IMPLIED.

LIMITATIONS OF LIABILITY

OMRON SHALL NOT BE RESPONSIBLE FOR SPECIAL, INDIRECT, OR CONSEQUENTIAL DAMAGES, LOSS OF PROFITS OR COMMERCIAL LOSS IN ANY WAY CONNECTED WITH THE PRODUCTS, WHETHER SUCH CLAIM IS BASED ON CONTRACT, WARRANTY, NEGLIGENCE, OR STRICT LIABILITY.

In no event shall the responsibility of OMRON for any act exceed the individual price of the product on which liability is asserted.

IN NO EVENT SHALL OMRON BE RESPONSIBLE FOR WARRANTY, REPAIR, OR OTHER CLAIMS REGARDING THE PRODUCTS UNLESS OMRON'S ANALYSIS CONFIRMS THAT THE PRODUCTS WERE PROPERLY HANDLED, STORED, INSTALLED, AND MAINTAINED AND NOT SUBJECT TO CONTAMINATION, ABUSE, MISUSE, OR INAPPROPRIATE MODIFICATION OR REPAIR.

Application Considerations

SUITABILITY FOR USE

OMRON shall not be responsible for conformity with any standards, codes, or regulations that apply to the combination of products in the customer's application or use of the products.

At the customer's request, OMRON will provide applicable third party certification documents identifying ratings and limitations of use that apply to the products. This information by itself is not sufficient for a complete determination of the suitability of the products in combination with the end product, machine, system, or other application or use.

The following are some examples of applications for which particular attention must be given. This is not intended to be an exhaustive list of all possible uses of the products, nor is it intended to imply that the uses listed may be suitable for the products:

- Outdoor use, uses involving potential chemical contamination or electrical interference, or conditions or uses not described in this catalog.
- Nuclear energy control systems, combustion systems, railroad systems, aviation systems, medical equipment, amusement machines, vehicles, safety equipment, and installations subject to separate industry or government regulations.
- Systems, machines, and equipment that could present a risk to life or property.

Please know and observe all prohibitions of use applicable to the products.

NEVER USE THE PRODUCTS FOR AN APPLICATION INVOLVING SERIOUS RISK TO LIFE OR PROPERTY WITHOUT ENSURING THAT THE SYSTEM AS A WHOLE HAS BEEN DESIGNED TO ADDRESS THE RISKS, AND THAT THE OMRON PRODUCTS ARE PROPERLY RATED AND INSTALLED FOR THE INTENDED USE WITHIN THE OVERALL EQUIPMENT OR SYSTEM.

PROGRAMMABLE PRODUCTS

OMRON shall not be responsible for the user's programming of a programmable product, or any consequence thereof.

Disclaimers

CHANGE IN SPECIFICATIONS

Product specifications and accessories may be changed at any time based on improvements and other reasons.

It is our practice to change model numbers when published ratings or features are changed, or when significant construction changes are made. However, some specifications of the products may be changed without any notice. When in doubt, special model numbers may be assigned to fix or establish key specifications for your application on your request. Please consult with your OMRON representative at any time to confirm actual specifications of purchased products.

DIMENSIONS AND WEIGHTS

Dimensions and weights are nominal and are not to be used for manufacturing purposes, even when tolerances are shown.

PERFORMANCE DATA

Performance data given in this catalog is provided as a guide for the user in determining suitability and does not constitute a warranty. It may represent the result of OMRON's test conditions, and the users must correlate it to actual application requirements. Actual performance is subject to the OMRON Warranty and Limitations of Liability.

ERRORS AND OMISSIONS

The information in this document has been carefully checked and is believed to be accurate; however, no responsibility is assumed for clerical, typographical, or proofreading errors, or omissions.

2009.9

In the interest of product improvement, specifications are subject to change without notice.

OMRON Corporation
Industrial Automation Company

<http://www.ia.omron.com/>

(c)Copyright OMRON Corporation 2009 All Right Reserved.