

Cat. No.  
W248-E1-2

**SYSMAC**  
C-series and CVM1 PCs  
**SYSMAC Support Software**

**OPERATION MANUAL:  
C-series PCs**

**OMRON**

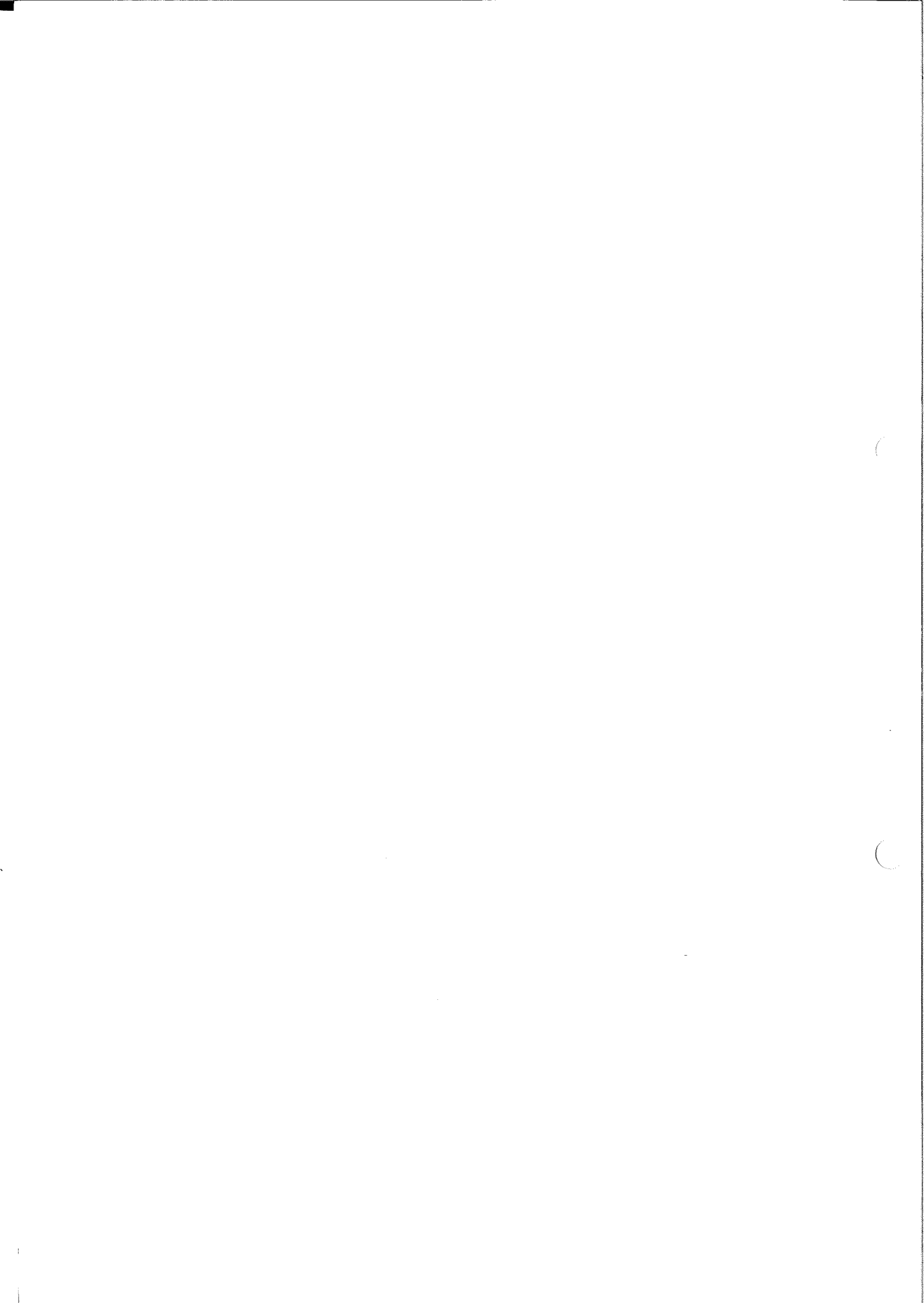







# **SYSMAC C-series and CVM1 PCs SYSMAC Support Software**

## **Operation Manual: C-series PCs**

*Produced May 1996*





## **Notice:**

OMRON products are manufactured for use according to proper procedures by a qualified operator and only for the purposes described in this manual.

The following conventions are used to indicate and classify precautions in this manual. Always heed the information provided with them. Failure to heed precautions can result in injury to people or damage to the product.

 **DANGER!** Indicates information that, if not heeded, is likely to result in loss of life or serious injury.

 **WARNING** Indicates information that, if not heeded, could possibly result in loss of life or serious injury.

 **Caution** Indicates information that, if not heeded, could result in relatively serious or minor injury, damage to the product, or faulty operation.

## **OMRON Product References**

All OMRON products are capitalized in this manual. The word "Unit" is also capitalized when it refers to an OMRON product, regardless of whether or not it appears in the proper name of the product.

The abbreviation "Ch," which appears in some displays and on some OMRON products, often means "word" and is abbreviated "Wd" in documentation in this sense.

The abbreviation "PC" means Programmable Controller and is not used as an abbreviation for anything else.

## **Visual Aids**

The following headings appear in the left column of the manual to help you locate different types of information.

**Note** Indicates information of particular interest for efficient and convenient operation of the product.

**1, 2, 3...** 1. Indicates lists of one sort or another, such as procedures, checklists, etc.

### **© OMRON, 1995**

All rights reserved. No part of this publication may be reproduced, stored in a retrieval system, or transmitted, in any form, or by any means, mechanical, electronic, photocopying, recording, or otherwise, without the prior written permission of OMRON.

No patent liability is assumed with respect to the use of the information contained herein. Moreover, because OMRON is constantly striving to improve its high-quality products, the information contained in this manual is subject to change without notice. Every precaution has been taken in the preparation of this manual. Nevertheless, OMRON assumes no responsibility for errors or omissions. Neither is any liability assumed for damages resulting from the use of the information contained in this publication.





# TABLE OF CONTENTS

|   |             |
|---|-------------|
| <b>PRECAUTIONS</b> .....                        | <b>xiii</b> |
| 1 Intended Audience .....                       | xiv         |
| 2 General Precautions .....                     | xiv         |
| 3 Safety Precautions .....                      | xiv         |
| 4 Operating Environment Precautions .....       | xiv         |
| 5 Application Precautions .....                 | xv          |
| 6 Software Operating Precautions .....          | xvi         |
| <b>PART 1:</b>                                  |             |
| <b>INTRODUCTION</b> .....                       | <b>1</b>    |
| <b>SECTION 1</b>                                |             |
| <b>Saving and Retrieving Data</b> .....         | <b>3</b>    |
| 1-1 File Formats .....                          | 4           |
| 1-2 Saving and Retrieving DOS Files .....       | 4           |
| 1-3 Saving and Retrieving LSS Data Files .....  | 5           |
| <b>PART 2:</b>                                  |             |
| <b>OFFLINE OPERATION</b> .....                  | <b>7</b>    |
| <b>SECTION 2</b>                                |             |
| <b>Programming</b> .....                        | <b>9</b>    |
| 2-1 Getting Started .....                       | 10          |
| 2-2 Programming in Ladder Form .....            | 18          |
| 2-3 Storing and Checking Programs .....         | 65          |
| 2-4 Saving and Retrieving Programs .....        | 71          |
| 2-5 Searching in Ladder Diagrams .....          | 80          |
| 2-6 Editing Instruction Blocks .....            | 90          |
| 2-7 Editing I/O Comments .....                  | 93          |
| 2-8 Programming in the Mnemonic Mode .....      | 101         |
| <b>SECTION 3</b>                                |             |
| <b>Editing DM</b> .....                         | <b>111</b>  |
| 3-1 Editing DM .....                            | 112         |
| 3-2 Changing the Input Mode (HEX ↔ ASCII) ..... | 114         |
| 3-3 Writing and Editing DM Data .....           | 114         |
| 3-4 Reading DM Data .....                       | 115         |
| 3-5 Copying DM Data .....                       | 116         |
| 3-6 Filling DM Words with Same Value .....      | 116         |
| 3-7 Printing DM Data .....                      | 117         |
| 3-8 Saving DM Data .....                        | 117         |
| 3-9 Retrieving DM Data .....                    | 119         |
| 3-10 Initializing DM Data .....                 | 123         |
| <b>SECTION 4</b>                                |             |
| <b>Editing I/O Tables</b> .....                 | <b>125</b>  |
| 4-1 Editing I/O Tables .....                    | 126         |
| 4-2 I/O Table Errors .....                      | 128         |
| 4-3 Display Formats .....                       | 129         |
| 4-4 Writing I/O Tables .....                    | 131         |
| 4-5 Checking I/O Tables .....                   | 137         |
| 4-6 Saving/Retrieving I/O Tables .....          | 138         |
| 4-7 Printing I/O Tables .....                   | 139         |
| 4-8 Allocations to Special I/O Units .....      | 140         |

|                           |                               |            |
|---------------------------|-------------------------------|------------|
| <b>SECTION 5</b>          |                               |            |
| <b>Utility Operations</b> | .....                         | <b>143</b> |
| 5-1                       | The Utility Menu              | 144        |
| 5-2                       | Displaying Data Lists         | 145        |
| 5-3                       | Globally Changing Addresses   | 149        |
| 5-4                       | Printing Lists                | 157        |
| 5-5                       | Manipulating EPROM            | 164        |
| 5-6                       | Converting Programs           | 175        |
| 5-7                       | Creating LSS Data Libraries   | 177        |
| 5-8                       | Time Chart Monitor Data       | 178        |
| 5-9                       | Instruction Trace Data        | 179        |
| 5-10                      | Data Trace Data               | 179        |
| 5-11                      | Instructions Tables           | 180        |
| 5-12                      | Expansion Instructions        | 185        |
| 5-13                      | PC Setup                      | 187        |
| 5-14                      | Allocating UM                 | 199        |
| <b>SECTION 6</b>          |                               |            |
| <b>System Setup</b>       | .....                         | <b>205</b> |
| 6-1                       | System Setup Menu             | 206        |
| 6-2                       | System Setup Parameters       | 207        |
| <b>SECTION 7</b>          |                               |            |
| <b>File Management</b>    | .....                         | <b>217</b> |
| 7-1                       | File Management Operations    | 218        |
| 7-2                       | DOS File Operations           | 219        |
| 7-3                       | LSS File Operations           | 224        |
| <b>SECTION 8</b>          |                               |            |
| <b>Option Menu</b>        | .....                         | <b>231</b> |
| 8-1                       | Introduction                  | 232        |
| 8-2                       | Registering a Utility         | 232        |
| 8-3                       | Deleting a Utility            | 234        |
| 8-4                       | Changing a Registered Utility | 235        |
| 8-5                       | Starting a Utility            | 236        |

# TABLE OF CONTENTS

## PART 3:

### ONLINE OPERATION ..... 237

#### SECTION 9

#### Going Online ..... 239

- 9-1 Preparations ..... 240
- 9-2 Going Online ..... 241

#### SECTION 10

#### Monitoring ..... 243

- 10-1 Monitoring ..... 244
- 10-2 Monitoring Displays ..... 244
- 10-3 Transferring Programs ..... 246
- 10-4 Clearing Data Areas ..... 255
- 10-5 Searching in Ladder Diagrams ..... 257
- 10-6 Changing the Display Mode ..... 260
- 10-7 Pause ..... 265
- 10-8 Differential Monitor ..... 269
- 10-9 Clearing Errors ..... 271
- 10-10 Monitor Data Operations ..... 271
- 10-11 Online Editing ..... 286
- 10-12 Reading the Cycle Time ..... 290
- 10-13 Displaying Memory Usage ..... 290

#### SECTION 11

#### Editing DM ..... 293

- 11-1 The DM Display and DM Menu ..... 294
- 11-2 Transferring and Comparing DM Data ..... 296

#### SECTION 12

#### Editing I/O Tables ..... 301

- 12-1 Introduction ..... 302
- 12-2 Creating I/O Tables ..... 304
- 12-3 Changing I/O Tables ..... 305
- 12-4 Verifying I/O Tables ..... 307
- 12-5 Transferring and Comparing I/O Tables ..... 307
- 12-6 Clearing I/O Tables ..... 308
- 12-7 Replacing I/O Units during Operation ..... 308

#### SECTION 13

#### Utility Operations ..... 311

- 13-1 The Utility Menu ..... 312
- 13-2 File Memory Operations ..... 312
- 13-3 Time Chart Monitoring ..... 323
- 13-4 Instruction Traces ..... 327
- 13-5 Data Traces ..... 330
- 13-6 Debugging ..... 335
- 13-7 Reading and Setting the Clock ..... 337
- 13-8 Transferring Expansion Instructions ..... 337
- 13-9 PC Setup ..... 337

|   |            |
|---|------------|
| <b>PART 4:</b>                                      |            |
| <b>NETWORKS</b> .....                               | <b>339</b> |
| <b>SECTION 14</b>                                   |            |
| <b>SYSMAC NET Data Link Communications</b> .....    | <b>341</b> |
| 14-1 SYSMAC NET Data Link Communications .....      | 342        |
| 14-2 Overall Procedure .....                        | 342        |
| 14-3 SYSMAC NET Data Link Table Menu .....          | 343        |
| 14-4 Transferring Data Link Tables .....            | 349        |
| 14-5 Creating and Modifying Routing Tables .....    | 351        |
| <b>SECTION 15</b>                                   |            |
| <b>SYSMAC LINK Data Link Communications</b> .....   | <b>353</b> |
| 15-1 Introduction .....                             | 354        |
| 15-2 Offline SYSMAC LINK Data Link Table Menu ..... | 355        |
| 15-3 Online SYSMAC LINK Data Link Table Menu .....  | 363        |
| <b>PART 5:</b>                                      |            |
| <b>APPENDICES</b> .....                             | <b>379</b> |
| A Error Messages .....                              | 381        |
| B Offline Operations .....                          | 387        |
| C Online Operations .....                           | 393        |
| <b>Glossary</b> .....                               | <b>397</b> |
| <b>Index</b> .....                                  | <b>399</b> |
| <b>Revision History</b> .....                       | <b>413</b> |

## About this Manual:

This manual describes operating procedures for SYSMAC C-series Programmable Controllers (PCs) using the SYSMAC Support Software (SSS) running on an IBM PC/AT or compatible computer.

This manual is designed to be used together with two other SSS Operation Manuals. The entire set of CVSS manuals is listed below. (The revision numbers have been omitted from the catalog numbers; be sure you are using the most current revision for your version of the SSS.)

| Manual   | Content  | Cat. No. |
|--|--|----------|
| SYSMAC Support Software Operation Manual:<br><b>Basics</b>                 | SSS installation procedures, hardware information for the SSS, and general basic operating procedures (including data conversion between C-series and CVM1 PCs). | W247-E1  |
| SYSMAC Support Software Operation Manual:<br><b>C-series PC Operations</b> | Detailed operating procedures for the C-series PCs.  | W248-E1  |
| SYSMAC Support Software Operation Manual:<br><b>CVM1 Operations</b>        | Detailed operating procedures for CVM1 PCs.  | W249-E1  |

This manual does not cover basic operating procedures for the SSS. If you are not yet familiar with SSS operating procedures, refer to the *SYSMAC Support Software Operation Manual: Basics* for installation procedures and basic information.

This manual does not cover details on programming and on the operation of specific Units. This information is covered in the *Operation Manual* and *Installation Guide* for individual PCs or PC Units. Use these manuals together with the SSS manuals. Manuals on any special Units (e.g., SYSMAC NET Link Units or SYSMAC LINK Units) used with the PC will also be necessary.

Please read this manual completely together with the other manuals related to your PC system and be sure you understand the information provide before attempting to program or operate a C-series PC.

The basic content of each section of this manual is outlined below.

### Part 1: Introduction

**Section 1** describes the methods for inputting drive, path, and file names when carrying out operations involving saving or retrieving files. These operations are not explained in detail in subsequent sections.

### Part 2: Offline Operation

**Section 2** explains how to write, edit, save, retrieve, and delete programs in both ladder and mnemonic form. In particular, it explains how to use the various items on the Programming Menu and how to use the read, write, insert, and delete modes.

**Section 3** explains the various commands on the DM Menu. These operations are used to enter data to the DM Area as 4-digit hexadecimal or ASCII, to save and retrieve the contents of the DM Area to and from a data disk or hard disk, and to print a memory map of the DM contents.

**Section 4** explains the various commands on the I/O Table Menu. These operations can be used to create and edit the I/O table at the computer and store it in the system work area, to check that the I/O table is correct, to save and retrieve the contents of the I/O table to and from a data disk or hard disk, and to print the contents of the I/O table.

**Section 5** explains the various commands within the Utility Menu. The Utility Menu contains a variety of operations used to manage programming, debugging, and system data.

**Section 6** describes the various parameters that are set to control SSS operation and communications with the PC and SSS peripherals.

**Section 7** explains how to manage files on data disks. Here, a data disk can be either a floppy disk or a directory on your hard disk.

**Section 8** describes how to register optional programs for execution from the Option Menu.

## Part 3: Online Operation

**Section 9** describes how to switch to online SSS operation. Online operation can be used to transfer programs and data between the SSS and the PC, to control and monitor PC operation, to debug the program, and to edit data and the program in the PC.

**Section 10** describes the operations used to transfer the program between the computer and PC, to monitor program execution in the PC, and to edit programs online.

**Section 11** explains the commands within the DM Menu. These operations are used to transfer DM area data between the PC and computer, compare the PC's DM data with the computer's DM data, and monitor/edit the PC's DM data.

**Section 12** explains the various commands within the I/O Table Menu. These operations can be used to create, edit, and transfer the PC's I/O table from the computer.

**Section 13** explains the various commands within the Utility Menu. The Utility Menu contains a variety of operations used to debug and control the PC.

## Part 4: Networks

**Section 14** provides information on setting up, controlling, and maintaining data links in SYSMAC NET Systems and on creating a routing table for the SSS so that PCs on remote SYSMAC NET networks can be communicated with.

## Part 5: Appendices

**Appendix A** lists the error messages that may be displayed. By referring to this table, corrective action can be taken to correct an error.

**Appendix B** lists the basic SSS offline operations.

**Appendix C** lists the basic SSS online operations.

**Note:** The SYSMAC Support Software uses the file compression utility DIET and the compress library management program LHA. LHA is the creation of Mr. H. Yoshisaki and all rights to this program belong to him.



### **WARNING**

Failure to read and understand the information provided in this manual may result in personal injury or death, damage to the product, or product failure. Please read each section in its entirety and be sure you understand the information provided in the section and related sections before attempting any of the procedures or operations given.



# PRECAUTIONS

This section provides general precautions for using the Programmable Controller (PC) and related devices.

**The information contained in this section is important for the safe and reliable application of the PC. You must read this section and understand the information contained before attempting to set up or operate a PC system.**

|   |     |
|---|-----|
| 1 Intended Audience .....                 | xiv |
| 2 General Precautions .....               | xiv |
| 3 Safety Precautions .....                | xiv |
| 4 Operating Environment Precautions ..... | xiv |
| 5 Application Precautions .....           | xv  |
| 6 Software Operating Precautions .....    | xvi |

## 1 Intended Audience

This manual is intended for the following personnel, who must also have knowledge of electrical systems (an electrical engineer or the equivalent).

- Personnel in charge of installing FA systems.
- Personnel in charge of designing FA systems.
- Personnel in charge of managing FA systems and facilities.

## 2 General Precautions

The user must operate the product according to the performance specifications described in the operation manuals.

Before using the product under conditions which are not described in the manual or applying the product to nuclear control systems, railroad systems, aviation systems, vehicles, combustion systems, medical equipment, amusement machines, safety equipment, and other systems, machines, and equipment that may have a serious influence on lives and property if used improperly, consult your OMRON representative.

Make sure that the ratings and performance characteristics of the product are sufficient for the systems, machines, and equipment, and be sure to provide the systems, machines, and equipment with double safety mechanisms.

This manual provides information for programming and operating OMRON PCs. Be sure to read this manual before attempting to use the software and keep this manual close at hand for reference during operation.

 **WARNING** It is extremely important that a PC and all PC Units be used for the specified purpose and under the specified conditions, especially in applications that can directly or indirectly affect human life. You must consult with your OMRON representative before applying a PC System to the abovementioned applications.

## 3 Safety Precautions

 **WARNING** Never attempt to disassemble any Units while power is being supplied. Doing so may result in serious electrical shock or electrocution.

 **WARNING** Never touch any of the terminals while power is being supplied. Doing so may result in serious electrical shock or electrocution.

## 4 Operating Environment Precautions

Do not operate the control system in the following places.

- Where the PC is exposed to direct sunlight.
- Where the ambient temperature is below 0°C or over 55°C.
- Where the PC may be affected by condensation due to radical temperature changes.
- Where the ambient humidity is below 10% or over 90%.
- Where there is any corrosive or inflammable gas.
- Where there is excessive dust, saline air, or metal powder.
- Where the PC is affected by vibration or shock.
- Where any water, oil, or chemical may splash on the PC.

 **Caution** The operating environment of the PC System can have a large effect on the longevity and reliability of the system. Improper operating environments can lead to malfunction, failure, and other unforeseeable problems with the PC System. Be sure that the operating environment is within the specified conditions at installation and remains within the specified conditions during the life of the system.

## 5 Application Precautions

Observe the following precautions when using the PC.

 **WARNING** Failure to abide by the following precautions could lead to serious or possibly fatal injury. Always heed these precautions.

- Always ground the system to 100  $\Omega$  or less when installing the system to protect against electrical shock.
- Always turn off the power supply to the PC before attempting any of the following. Performing any of the following with the power supply turned on may lead to electrical shock:
  - Mounting or removing any Units (e.g., I/O Units, CPU Unit, etc.) or memory cassettes.
  - Assembling any devices or racks.
  - Connecting or disconnecting any cables or wiring.

 **Caution** Failure to abide by the following precautions could lead to faulty operation of the PC or the system or could damage the PC or PC Units. Always heed these precautions.

- Use the Units only with the power supplies and voltages specified in the operation manuals. Other power supplies and voltages may damage the Units.
- Take measures to stabilize the power supply to conform to the rated supply if it is not stable.
- Provide circuit breakers and other safety measures to provide protection against shorts in external wiring.
- Do not apply voltages exceeding the rated input voltage to Input Units. The Input Units may be destroyed.
- Do not apply voltages exceeding the maximum switching capacity to Output Units. The Output Units may be destroyed.
- Always disconnect the LG terminal when performing withstand voltage tests.
- Install all Units according to instructions in the operation manuals. Improper installation may cause faulty operation.
- Provide proper shielding when installing in the following locations:
  - Locations subject to static electricity or other sources of noise.
  - Locations subject to strong electromagnetic fields.
  - Locations subject to possible exposure to radiation.
  - Locations near to power supply lines.
- Be sure to tighten Backplane screws, terminal screws, and cable connector screws securely.
- Do not attempt to take any Units apart, to repair any Units, or to modify any Units in any way.

 **Caution** The following precautions are necessary to ensure the general safety of the system. Always heed these precautions.

- Provide double safety mechanisms to handle incorrect signals that can be generated by broken signal lines or momentary power interruptions.
- Provide external interlock circuits, limit circuits, and other safety circuits in addition to any provided within the PC to ensure safety.

## 6 Software Operating Precautions

Observe the following precautions when using the Support Software.

 **WARNING** Never transfer programs to other nodes, change I/O memory at other nodes, or perform any other operations at other nodes without first confirming that the results of the action will not create a dangerous situation. Depending on the controlled system, changes to programs or data can result in serious injury or death.

 **Caution** Never edit a program or other data online without first confirming that no problems will result even if the cycle time is extended. Online editing can cause the cycle time to increase, possibly causing input signals to be read late or not at all. Depending on the controlled system, changes to cycle time can have serious and unexpected results.

 **Caution** Never use an incorrect program. Never change to a different program without first confirming operation and safety. Depending on the controlled system, an incorrect or inappropriate program can have serious and unexpected results.

 **Caution** Never change the PC's operating mode without first confirming that no problems will result in the controlled system. Depending on the controlled system, changes to the PC's operating mode can have serious and unexpected results.

 **Caution** Never force-set or force-reset bits in memory without first confirming that no problems will result in the controlled system. Depending on the controlled system, force-setting or force-resetting bits in memory can have serious and unexpected results.

 **Caution** Never change the present value of a timer or counter without first confirming that no problems will result in the controlled system. Depending on the controlled system, changes to the present value of a timer or counter can have serious and unexpected results.

 **Caution** Never change the set value of a timer or counter without first confirming that no problems will result in the controlled system. Depending on the controlled system, changes to the set value of a timer or counter can have serious and unexpected results.

# Part 1

# Introduction

This part of the manual covers procedures for saving and retrieving data from files. Refer to the *SYSMAC Support Software Operation Manual: Basics* for basic operating procedures for the SSS.





# SECTION 1

## Saving and Retrieving Data

The operations for saving and retrieving programs and data are standardized throughout the SYSMAC Support Software. This section describes in detail the methods for inputting drive, path, and file names when carrying out operations involving saving or retrieving files. These operations are not explained in detail in subsequent sections, so it will be helpful to master them now before proceeding further.

|     |  |   |
|-----|--|---|
| 1-1 | File Formats .....                         | 4 |
| 1-2 | Saving and Retrieving DOS Files .....      | 4 |
| 1-3 | Saving and Retrieving LSS Data Files ..... | 5 |

## 1-1 File Formats

The SSS allows you to save and retrieve PC data as DOS files. It is also still possible to save and retrieve in the LSS data format.

Regardless of the type of data that is being saved or retrieved, whether programs, I/O comment data, or DM data, the default setting is for saving and retrieving DOS files.

**Note** If you need to use data created on the SSS with the LSS, you will need to save in the LSS data format. The DOS format cannot be read by the LSS.

## 1-2 Saving and Retrieving DOS Files

The procedures for saving and retrieving DOS files are explained here using "S:Save program" from the Programming Menu as an example.

When the desired operation (i.e., saving or retrieving a program or data) is selected, the following menu will be displayed.

```

C200HS < >
|
|
| 0
| [ Programming ]
| [ Save program ]
|
| [ Save program ]
| Format [ DOS ]
| Input the name of the file to save
| A:\SSSDAT\
|
| E:Edit ladder
| N:Edit comments
| D:Retrieve comments
| M:Memory usage
| C:Clear memory
| F:Check program
| *:Edit intrupt prgrm
| *:Program input mode
|
|
| 1Format2 3 4 5 6 7 8 9 0
  
```

As mentioned above, the default setting is saving and retrieving DOS files. The path name that is set for the data disk drive under the System Setup will be displayed as the default. The default path name can be changed.

To bring up the screen for saving and retrieving LSS files, press the F1 Key on the DOS file screen.

### Inputting the Path Name

Input path names of no more than 66 normal characters.  
Example: B:\CCV\PROG

### Inputting the File Name

Input file names of no more than 8 normal characters.  
Example 1: PROG001  
Example 2: Process 1

### Inputting the Title

When the path and file names are input, and the Enter Key is pressed, the screen for inputting a title will be displayed. Input a title of no more than 30 normal characters. The title input here will be displayed when a file list screen is displayed.

### Selecting Files from a List

A list of files stored on a data disk can be displayed, and file names can be selected from that list.

To display the list, press the Escape Key while the screen for inputting path and file names is being displayed. The following screen will then be displayed.

| C200HS < >          |       | Read     | Ladr     |
|---------------------|-------|----------|----------|
| Path A:\SSSDAT\     |       |          |          |
| File                | Size  | Date     | PC model |
| <.. >               | <DIR> | 01/01/95 |          |
| TEMP                | 14280 | 01/01/95 | CQM1     |
| SAMPLE1 .SP1        | 12875 | 01/01/95 | C200HS   |
| SAMPLE2 .SP1        | 12754 | 01/01/95 | C1000H   |
| SAMPLE3 .SP1        |       |          |          |
| Comment             |       |          |          |
| sample 1            |       |          |          |
| sample 2            |       |          |          |
| Sample program data |       |          |          |
| 275kbytes available |       |          |          |
| 1Format2            | 3     | 4        | 5        |
| 6                   | 7     | 8        | 9        |
| 0                   |       |          |          |

First use the Up and Down Cursor Keys to select a file, and then input the file name by pressing the Enter Key.

### 1-3 Saving and Retrieving LSS Data Files

Press the F1 Key while the screen for saving and retrieving DOS files is being displayed. The following screen will be displayed. This is the screen for saving and retrieving LSS data files.

| C200HS < >                         |  | Read | Ladr |
|------------------------------------|--|------|------|
| 0                                  |  |      |      |
| [ Programming ]                    |  |      |      |
| [ Save program ]                   |  |      |      |
| [ Save ]                           |  |      |      |
| Format [ LSS ]                     |  |      |      |
| Input the name of the file to save |  |      |      |
| A:                                 |  |      |      |
| E:Edit ladder                      |  |      |      |
| N:Edit comments                    |  |      |      |
| D:Retrieve comments                |  |      |      |
| M:Memory usage                     |  |      |      |
| C:Clear memory                     |  |      |      |
| P:Check program                    |  |      |      |
| *:Edit intrupt prgrm               |  |      |      |
| *:Program input mode               |  |      |      |
| 1Format2Drive 3                    |  |      |      |
| 4                                  |  |      |      |
| 5                                  |  |      |      |
| 6                                  |  |      |      |
| 7                                  |  |      |      |
| 8                                  |  |      |      |
| 9                                  |  |      |      |
| 0                                  |  |      |      |

The drive name that is set for the data disk drive under the System Setup will be displayed.

**Note** To return to the screen for saving and retrieving DOS files, press the F1 Key on the LSS file screen.

**Changing the Drive Name** To change the drive name, first press the F2 Key to display an input area to change the drive name, then input a letter from A to Z and press the Enter Key.

**Inputting the File Name** Input a file name of no more than 8 normal characters.  
 Example 1: PROGRAM  
 Example 2: ProcCtrl

**Selecting Files from a List** A list of files stored on a data disk can be displayed, and file names can be selected from that list.

To display the list, press the Escape Key while the screen for inputting and file names is being displayed. The following screen will then be displayed.

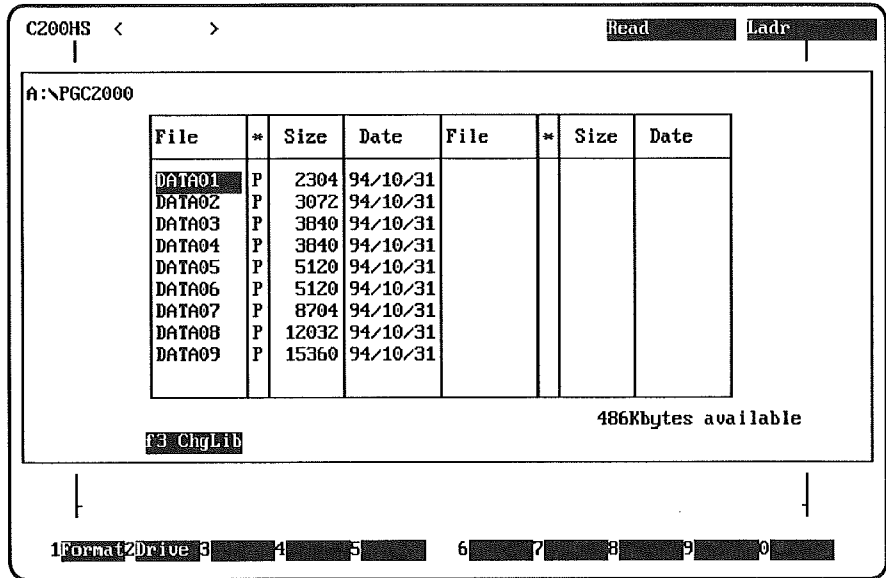

First use the Up and Down Cursor Keys to select a file, and then input the file name by pressing the Enter Key.

To change the library, press the F1 Key while the screen for selecting files is being displayed. Use the Cursor Keys to select a library, and press the Enter Key. The screen for selecting from the list of files in that library will then be displayed.

# Part 2

## Offline Operation

This part of the manual covers procedures for operations performed offline (i.e., while not connected to a PC). These operations are used to write programs and otherwise prepare and manage data for later transfer to PCs online or to manage data transferred from PCs.





## SECTION 2

# Programming

This section explains how to write, edit, save, retrieve, and delete programs in both ladder and mnemonic form. In particular, it explains how to use the various items on the Programming Menu and how to use the read, write, insert, and delete modes.

|        |  |     |
|--------|--|-----|
| 2-1    | Getting Started .....                                  | 10  |
| 2-1-1  | Before Programming .....                               | 10  |
| 2-1-2  | Clearing Memory .....                                  | 12  |
| 2-1-3  | Changing Display Modes .....                           | 13  |
| 2-1-4  | Displaying Memory Usage .....                          | 17  |
| 2-2    | Programming in Ladder Form .....                       | 18  |
| 2-2-1  | Creating a Ladder Diagram .....                        | 18  |
| 2-2-2  | Entering Input Conditions .....                        | 20  |
| 2-2-3  | Entering Right-hand Instructions .....                 | 21  |
| 2-2-4  | Entering Bit/Word Addresses and Data .....             | 22  |
| 2-2-5  | Program Input Example .....                            | 23  |
| 2-2-6  | Writing and Deleting Line Connections .....            | 30  |
| 2-2-7  | Continuing Instruction Lines .....                     | 40  |
| 2-2-8  | Editing Ladder Diagrams .....                          | 42  |
| 2-2-9  | Creating I/O, Instruction, and Block Comments .....    | 56  |
| 2-2-10 | Creating I/O Comments .....                            | 56  |
| 2-2-11 | Creating Block Comments .....                          | 59  |
| 2-2-12 | Creating Instruction Comments .....                    | 61  |
| 2-2-13 | Summary of Operations in Write Mode .....              | 63  |
| 2-3    | Storing and Checking Programs .....                    | 65  |
| 2-3-1  | Store/Store Insert .....                               | 65  |
| 2-3-2  | Checking the Program .....                             | 69  |
| 2-4    | Saving and Retrieving Programs .....                   | 71  |
| 2-4-1  | Saving Programs .....                                  | 71  |
| 2-4-2  | Retrieving Programs .....                              | 74  |
| 2-4-3  | Retrieving Comments .....                              | 76  |
| 2-5    | Searching in Ladder Diagrams .....                     | 80  |
| 2-5-1  | Searching and Reading Ladder Diagrams .....            | 80  |
| 2-5-2  | Finding I/O Comments and Block Comments .....          | 87  |
| 2-5-3  | Summary of Ladder Search/Read Operations .....         | 89  |
| 2-6    | Editing Instruction Blocks .....                       | 90  |
| 2-6-1  | Moving, Copying, and Deleting Instruction Blocks ..... | 90  |
| 2-7    | Editing I/O Comments .....                             | 93  |
| 2-7-1  | Comment Editing Operations .....                       | 93  |
| 2-7-2  | Writing and Modifying I/O Comments .....               | 95  |
| 2-7-3  | Moving and Copying I/O Comments .....                  | 96  |
| 2-7-4  | Clearing I/O Comment Data .....                        | 98  |
| 2-7-5  | Writing an I/O Comment to Multiple Addresses .....     | 99  |
| 2-7-6  | Deleting Unused Comments .....                         | 99  |
| 2-7-7  | Finding I/O Comments .....                             | 100 |
| 2-8    | Programming in the Mnemonic Mode .....                 | 101 |
| 2-8-1  | Mnemonic Programming .....                             | 101 |
| 2-8-2  | Mnemonic Programming Screen .....                      | 102 |
| 2-8-3  | Entering Mnemonic Programs .....                       | 103 |
| 2-8-4  | Writing Mnemonic Programs .....                        | 106 |
| 2-8-5  | Editing Mnemonic Programs .....                        | 107 |
| 2-8-6  | Searching and Reading Mnemonic Programs .....          | 108 |

## 2-1 Getting Started

This section explains the preliminary procedures that must be carried out before beginning programming.

### 2-1-1 Before Programming

The basic operations that must be carried out before beginning programming are outlined below. For details, refer to the relevant sections in the manual.

- 1, 2, 3...
1. Make the appropriate settings in the System Setup according to the system that is to be employed. (See *Section 6 System Setup*.)
  2. In the Programming Menu, use "C:Clear memory" to clear the user program and I/O comments from the system work area. (See *2-1-2 Clearing Memory*.)
  3. In the Programming Menu, use "H:Change display" to set the way in which the programming screen is displayed. (See *2-1-3 Changing the Display Mode*.)
  4. To begin actual programming, refer to later parts of this section. (See the table of contents for this section.)

#### Ladder Programming Screen

The ladder programming screen is used to create ladder programs. The function keys at the bottom of the screen can be used to carry out functions such as changing the editing mode and writing, storing, finding, and reading programs.

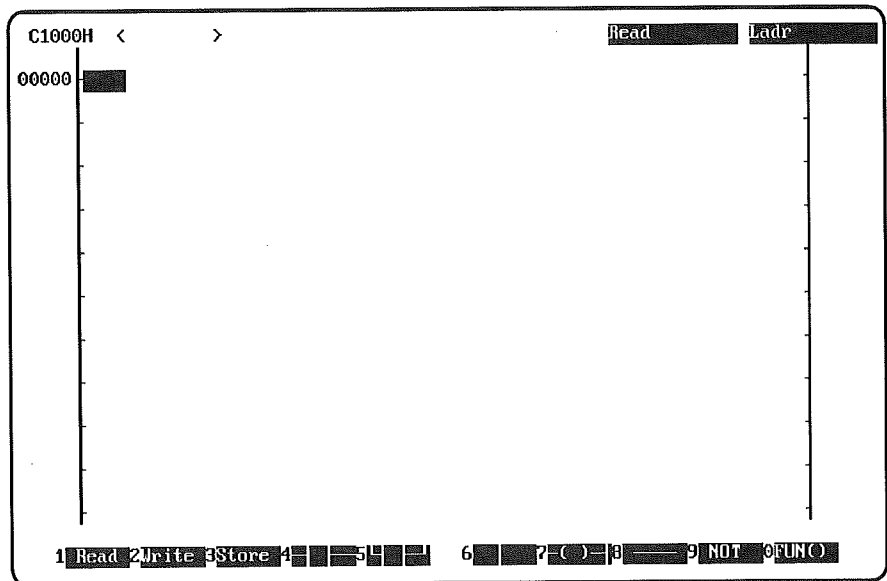

#### Shift + Function Keys

1 Dele 2 Inser 3 Strin 4 [Ladder Symbol] 5 [Ladder Symbol] 6 [Ladder Symbol] 7 (C) 8 SET 9 RSET 0 FUNC

↑  
CQM1, C200HS only

**Note** For CQM1 and C200HS Programmable Controllers, F8 is "SET" and F9 is "RSET."

**Editing Modes** The following editing modes can be selected with the function keys displayed at the bottom-left of the screen.

| Editing mode        |  | Function  |
|---------------------|--|---|
| Read                | Read (F1)                              | Set to display the program from the work disk on the screen.  |
|                     |  | Set to find a program address, instruction, operand, I/O comment, or block comment, and display it on the screen.   |
| Write               | Write (F2)                             | Set to create or edit a program on the screen.  |
|                     | Store (F3),<br>Enter                   | Set to write the ladder program created on the screen to the system work area. Ladder programs are not saved when they are created on the screen, so always execute "Store" or "Store insert" after creating or changing a program. |
|                     | Store insert<br>(Shift + F3),<br>Enter | This mode is not necessary when creating mnemonic programs on the screen as these programs are automatically written to the system work area as they are being input.   |
| Insert (Shift + F2) |  | Set to insert data into a program displayed on the screen.  |
| Delete (Shift + F1) |  | Set to clear a program displayed on the screen.   |

**Programming Menu**

To access the Programming Menu from the programming screen, either press the End Key or press Control + M. To return to the programming screen, either press the Escape Key or press Control + /.

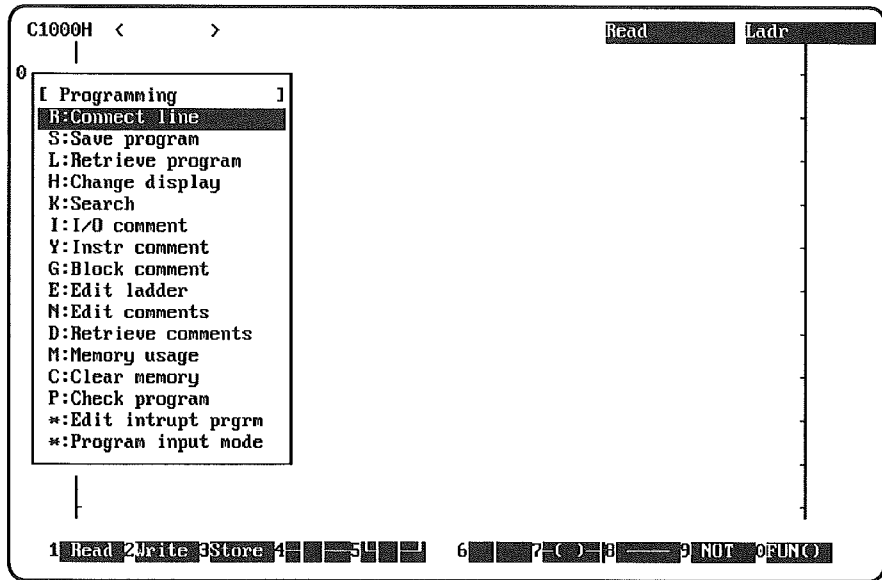

The following operations can be executed from the Programming Menu.

| Menu item           | Operation   | Page |
|---------------------|---|------|
| R:Connect line      | Creates connecting lines between programming elements (vertical line, symbols, etc.).               | 30   |
| S:Save program      | Writes the ladder or mnemonic program in the system work area to the data disk.                     | 71   |
| L:Retrieve program  | Reads the ladder or mnemonic program on the data disk to the system work area.                      | 74   |
| H:Change display    | Sets the method for displaying ladder diagrams and mnemonic programs.                               | 56   |
| K:Search            | Searches for instructions through their operands.   | 80   |
| I:I/O comment       | Finds and displays ladder diagrams, by means of writing and specifying I/O comments.                | 87   |
| Y:Instr comment     | Writes comments such as output conditions to output instructions.                                   | 61   |
| G:Block comment     | Writes block comments between instruction lines.  | 59   |
| E>Edit ladder       | Moves, copies, or deletes instruction blocks for a program in the system work area.                 | 90   |
| N>Edit comments     | Displays I/O comments on the screen 32 at a time, and edits the comments.                           | 93   |
| D:Retrieve comments | Reads I/O comments, instruction comments, and block comments from programs stored on the data disk. | 76   |
| M:Memory usage      | Displays how the memory area is being used in the system work area.                                 | 17   |
| C:Clear memory      | Clears the data in the system work area.  | 12   |
| P:Check program     | Checks whether ladder and mnemonic programs in the system work area are correct.                    | 69   |

**Note** The last two items on the Programming Menu are not supported by C-series PCs.

## 2-1-2 Clearing Memory

The "C:Clear memory" operation on the Programming Menu is used to clear the user program (including I/O comments, instruction comments, and block comments) from the system work area.

Always clear the memory before creating a program. Instruction comments, and block comments are cleared at the same time as the user program. I/O comments, however, are only cleared when the user program has been completely cleared (i.e., when the program address is 0).

The following types of data are not cleared by the "C:Clear memory" operation. They can be cleared using operations on other menus.

|                         |                 |
|-------------------------|-----------------|
| DM, I/O table           | Data link table |
| Time chart monitor data | Data trace data |
| Instruction trace data  |                 |

- Note**
1. To clear only I/O comments, use the "N>Edit comments" operation. (Refer to *2-7 Editing I/O Comments*.)
  2. To clear only parts of a program, use the "E>Edit ladder" operation. (Refer to *2-6 Editing Instruction Blocks*.)

### Clearing the Entire Program

The procedure for clearing the entire program from memory is as follows:

- 1, 2, 3... 1. Select "C:Clear memory" from the Programming menu.

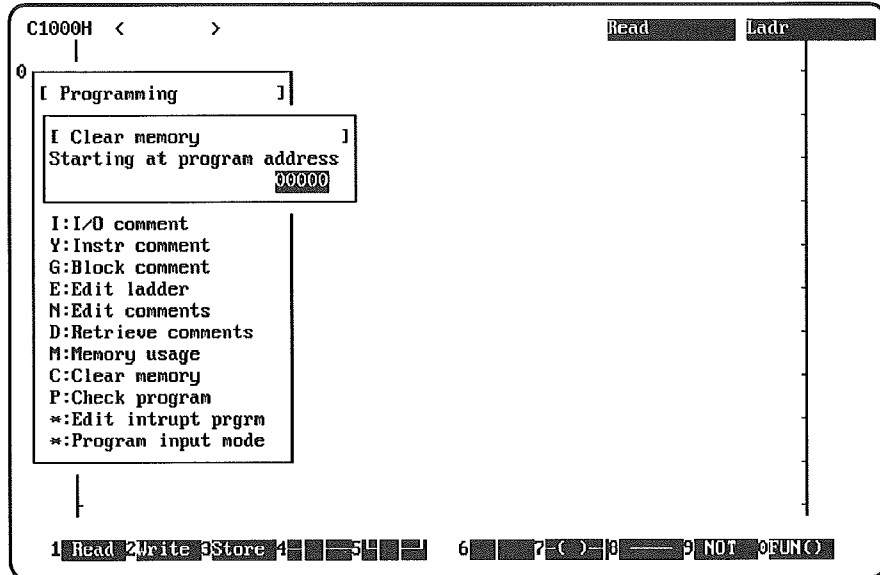

2. To clear the entire program, press Enter without inputting anything else.  
 or To clear the program from a particular program address until the end (i.e., to the final program address), specify the starting address of the part of the program to be cleared and then press Enter.  
 In either case, a message will be displayed asking for confirmation before the program is actually cleared.
3. Either press Enter to confirm that the program is to be cleared or select "N" and press Enter to cancel the operation. Once the program has been cleared, the display will return to the programming screen.

### 2-1-3 Changing Display Modes

Use the "H:Change display" operation on the Programming Menu to change the display mode of the basic programming screen to any of the four modes shown in the following table. It is also possible to toggle between the two ladder diagram modes by using Control + G.

#### Program Display Modes

| Display mode                      | Function   |
|-----------------------------------|--|
| Ladder diagram (without comments) | Set to create and display ladder programs with no comments.  |
| Ladder /w comments                | Set to create and display ladder programs with comments.   |
| Mnemonic (F keys)                 | Set to create and display programs in mnemonic code. Function keys are used to write instructions.     |
| Mnemonic (typed)                  | Set to create and display programs in mnemonic code. Alphanumeric keys are used to write instructions. |

**Caution** After creating a program using either of the ladder display modes, be sure to execute "Store/Store insert." If this is not done, the ladder program will be cleared when the display is changed. After "Store/Store insert" has been executed, the display can be changed without losing the ladder program.

#### Instruction Blocks

An instruction line and all interconnecting instruction lines is called an instruction block. A single instruction block can contain up to 22 instruction lines. When the maxi-

When the maximum number of 22 instruction lines is reached, execute the "Store" operation. Instruction blocks requiring more than 22 instruction lines cannot be written in ladder form and must be written in mnemonic form instead.

When several inputs are placed in an OR configuration or when there are multiple input conditions, as in special instructions, these are counted as multiple instruction lines within the instruction block.

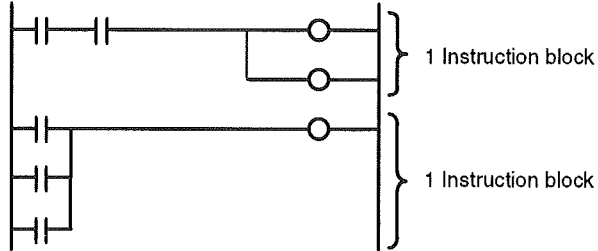

**Display Modes**

The display for each of the display modes is shown below.

**Ladder Diagram (Without Comments)**

Up to 11 instruction lines can be displayed on the screen at a time.

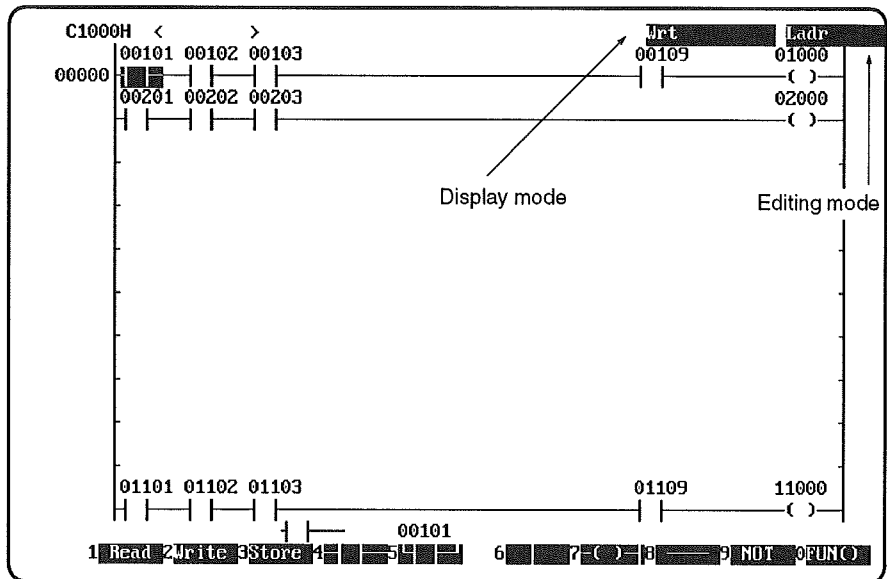

Ladder Diagram W/Comments

Up to 5 instruction lines can be displayed on the screen at a time.

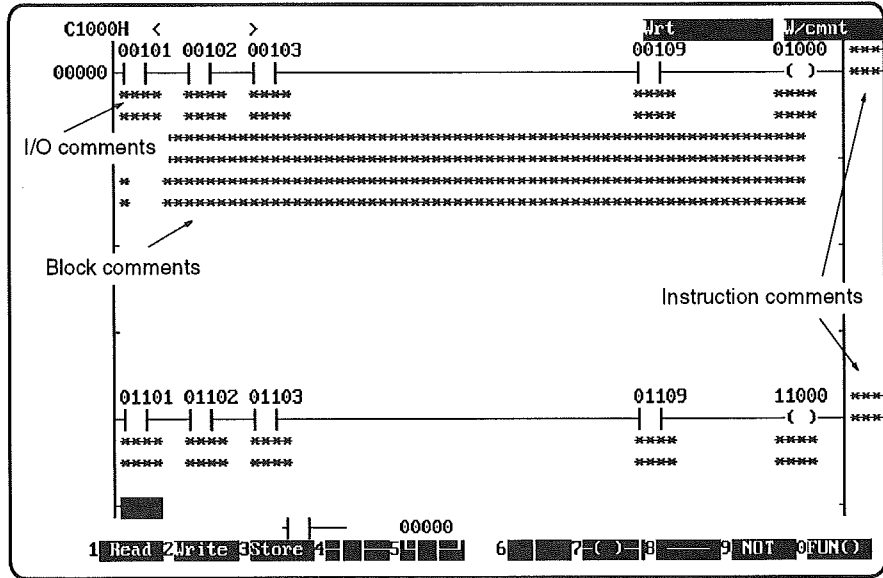

Mnemonics with Function Keys and Typed Mnemonics

Although the methods of inputting instructions are different for mnemonic and mnemonic with alphanumeric input, the display format is the same.

On a mnemonic screen, all I/O comments that have been created can be displayed. An I/O comment can contain a maximum of 16 characters.

Neither block comments nor instruction comments can be created on a mnemonic screen. They must be created on a ladder diagram screen.

In mnemonic form, programs are automatically written to the system work area as they are input.

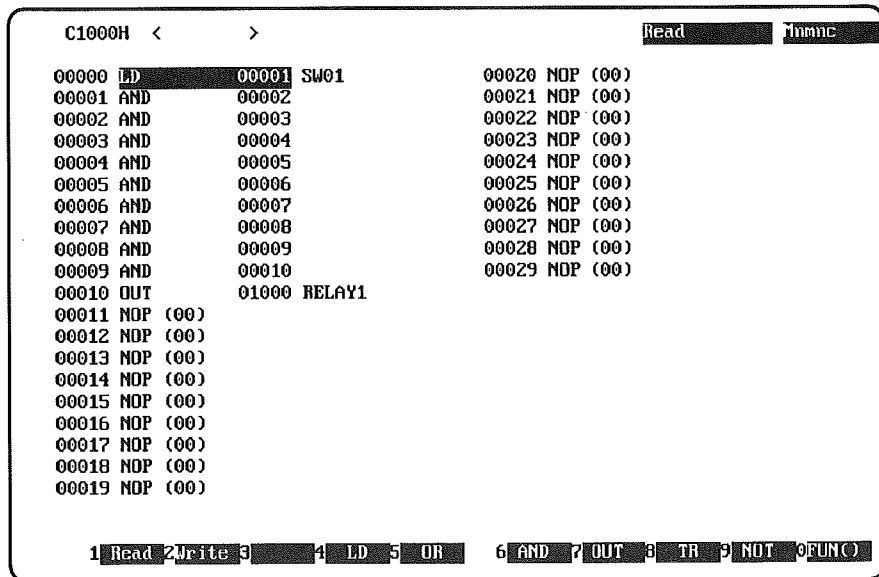

## Procedure for Changing the Display Mode

- 1, 2, 3... 1. Select "H:Change display" from the Programming Menu.

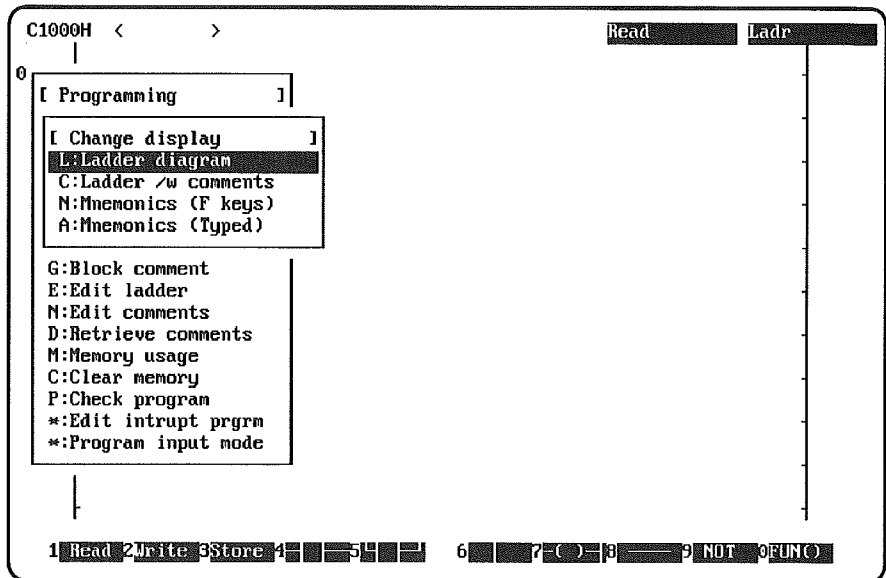

2. Move the cursor to select the desired display mode, and press Enter. The selected mode will appear, and the display mode will be shown at the upper right of the screen. The default setting is for ladder diagrams with no comments.
3. If the store or store insert operation has are not executed after inputting or changing instructions, the following message will be displayed when "H:Change display" is selected.

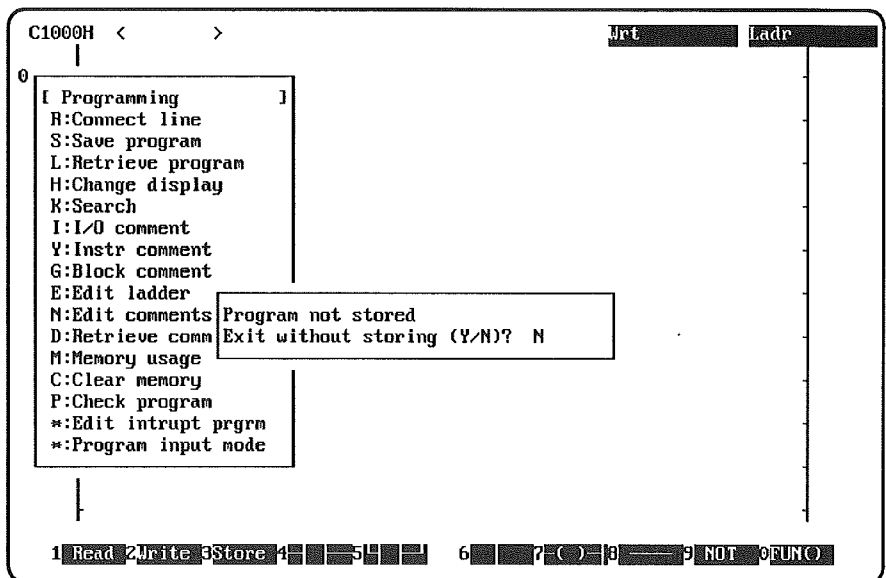

Either press Enter or input "N" and press Enter, and then execute the store operation. You can then change the display mode without losing the program.



## 2-1-4 Displaying Memory Usage

The "M:Memory usage" command on the Programming Menu displays the number of words currently being used in the program memory in the system work area, and also displays the memory capacity required when transferring a program to the Programmable Controller.

When this command is selected from the Programming Menu, the number of words currently being used in the programming memory, the number of comments used, the number of words used in special areas (e.g., Expansion DM) and the percentage of the work space still available will be displayed.

The storage capacity of the program memory area differs according to which Programmable Controller is used. The following table lists the capacity of each Programmable Controller.

| Model           | Storage Capacity           |
|-----------------|----------------------------|
| C20             | 1,194 addresses            |
| C120            | 8K bytes                   |
| C500            | 16K or 24K bytes           |
| C1000H, C2000H  | 8K, 16K, 24K, or 32K words |
| P-type PCs      | 1,194 addresses            |
| K-type PCs      | 1,194 addresses            |
| C200H           | 2,878 or 6,974 words       |
| C200HS          | 15.2K words                |
| Mini H-type PCs | 2,878 words                |
| CQM1            | 3.2K or 7.2K words         |

### Procedure

To display the current memory usage conditions, simply select "M:Memory usage" from the Programming Menu. The conditions will then be displayed.

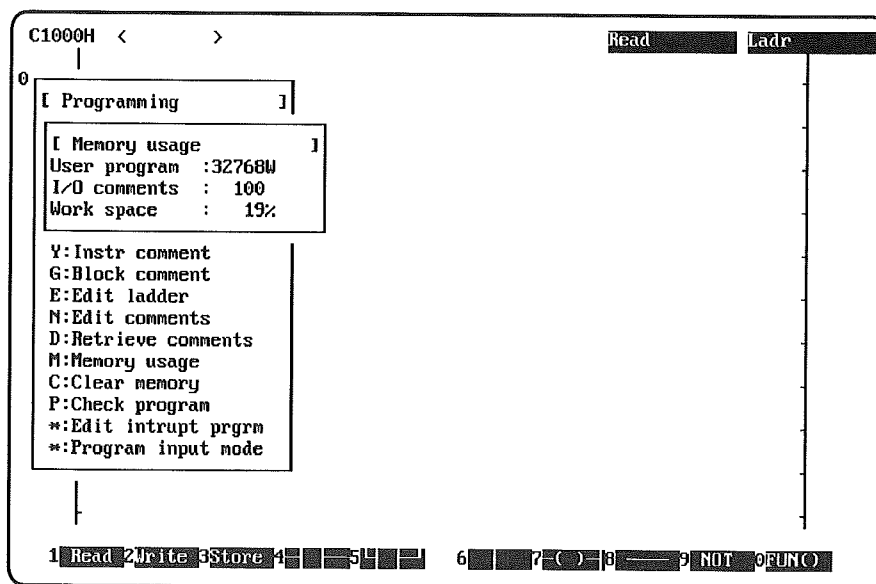

If the Programmable Controller is a C200HS, the following display will appear. For information on the I/O comment area and the expansion DM area, refer to 5-14 *Allocating UM*.

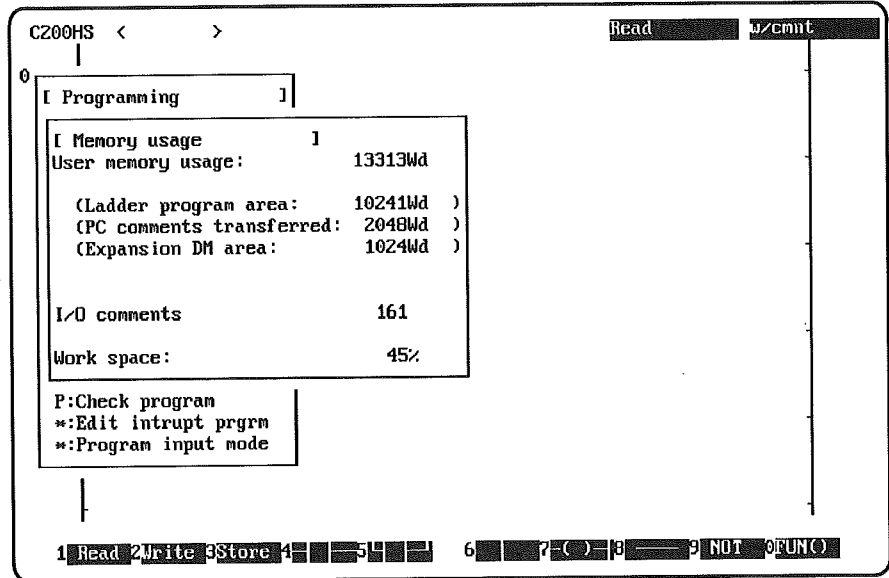

- User Program (User Memory Usage)** Program capacity is displayed up to the first END instruction in the user program stored in the system work area. If there is no END instruction in the program, the entire user program capacity will be shown. I/O comments, block comments, and instruction comments are not included.
- Ladder Program Area** The number of words used for the ladder program.
- PC Comments Transferred** The number of comments that would be transferred with the program as it currently exits.
- Expansion DM Area** The number of words used in the Expansion DM Area
- I/O Comments** The number of I/O comments used. A maximum of 3,500 I/O comments can be used.
- Work Space** The percentage of user program capacity still available in the system work area is displayed. The user program area includes instruction comments and block comments.

## 2-2 Programming in Ladder Form

This section explains how to create and revise ladder diagrams.

### 2-2-1 Creating a Ladder Diagram

#### Preparations

- System Setup** Set the Programmable Controller model that is to be used on the System Setup, and set all of the required items according to the system that is to be used.
- Clearing Memory** Use the "C:Clear memory" command to delete the contents of the memory before creating a new program. Existing programs will be overwritten if not deleted before a new program is written.
- Retrieving the Program** When modifying or adding to an existing program, use the "L:Retrieve program" command to write the program stored on the data disk to the system work area.

**Setting the Display Mode** The default display mode is "Ladder diagram" (without comments). To set another display mode, execute "H:Change display" from the Programming Menu.

**Checking the Program** Programs must be checked to be sure the maximum addresses for the respective PCs have not been exceeded for I/O bits and operand ranges. "P:Check program" checks these limits according to the Programmable Controller set in the System Setup.

**Caution** Whenever creating a new program or modifying an existing one, be sure to store the program by executing the "Store" operation (i.e., the F3, Enter). After the program has been finished or whenever a section of a large program has been finished, save the program to the data disk by executing "S:Save program" from the Programming Menu.

**Ladder Program Input Screen**

**Editing Mode** The editing mode and display mode are displayed at the top-right of the screen. The default editing mode is the read mode. Use function keys F1 through F3 to change the mode.

To create or modify a ladder program, press the F2 key to enter the Write mode. The Write mode screen appears as follows:

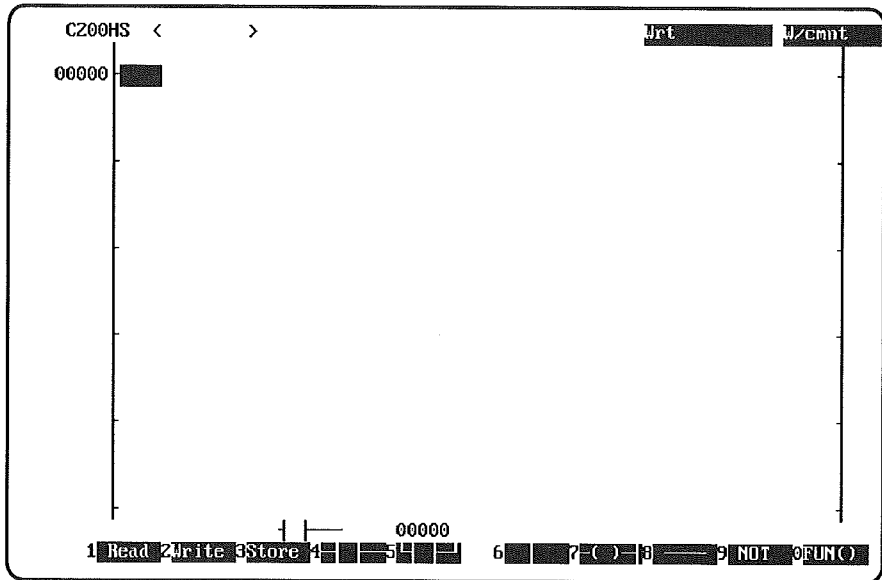

**Shift + Function Keys**



CQM1, C200HS only

**Function Keys** The function keys (F1 to F10) are located at the bottom of the screen. The function allocated to the function keys can be changed by holding down the Shift Key.

**Note** For CQM1 and C200HS Programmable Controllers, F8 is "SET" and F9 is "RSET."

**Number of Instruction Lines**

The maximum number of instruction lines allowed in a ladder diagram is 22, including the portion of the program which is not appearing on the screen. The number of instruction lines that can be displayed on the screen at one time is as follows:





- Ladder diagram: 11
- Ladder w/ comments: 5

**Moving the Cursor**

- Press the Up and Down Cursor Keys to move the cursor up and down through the 22 instruction lines (to the top and the bottom).
- Press the Left Cursor Key to move the cursor to the left; from the left edge of the screen, the cursor will move to the right edge.
- Press the Right Cursor Key to move the cursor to the right; from the right edge of the screen, the cursor will move to the left edge.

**2-2-2 Entering Input Conditions**

There are four types of input conditions that can be entered in a ladder diagram. To enter an input condition, press the function key represented by the appropriate symbol. Then enter the bit address for that input. The four types of conditions and their symbols are shown in the following table.

| Instruction       | Symbol   | Function key inputs   |
|-------------------|--|---|
| LD<br>AND         | Normally open<br>       | <i>Bit_address</i> Enter  |
| LD NOT<br>AND NOT | Normally closed<br>     | F9 <i>Bit_address</i> Enter<br>Shift+F4 <i>Bit_address</i> Enter    |
| OR                | OR: Normally open<br>   | F5 <i>Bit_address</i> Enter   |
| OR NOT            | OR: Normally closed<br> | F5 F9 <i>Bit_address</i> Enter<br>Shift+F5 <i>Bit_address</i> Enter |

After the program is stored, input bits set by DIFU and by DIFD are shown on the read screen as follows:

Set by DIFU: 

Set by DIFD: 

- Note**
1. For information on inputting bit addresses, refer to 2-2-4 *Entering Bit/Word Addresses and Data*.
  2. If there are too many input conditions to fit on one program line, use the "continue instruction" operation. For details, refer to 2-2-7 *Continuing Instruction Lines*.

### 2-2-3 Entering Right-hand Instructions

The output instructions and other instructions connecting to the right bus bar that can be used in ladder programs are shown in the following table, along with their symbols. Bit operands, word operands, timer numbers, or counter numbers are designated.

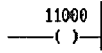
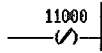
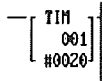
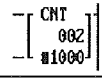
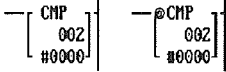
| Instruction  | Symbol  |
|--|---|
| OUTPUT   |  |
| OUTPUT NOT   |  |
| TIMER  |  |
| COUNTER  |  |
| Instructions with function codes<br>(differentiated instructions: @) |  |
| Block programming instructions<br>(mnemonic)                         | <i>mnemonic &lt;function_code&gt;</i>   |

The following table shows the function key sequences for entering each type of instructions.

| Instruction                              | Keys used   |
|--|---|
| OUT                                      | <b>F7</b> <i>Bit_address</i> <b>Enter</b>   |
| OUT NOT                                  | <b>F7</b> <b>F9</b> <i>Bit_address</i> <b>Enter</b><br>or<br><b>Shift+F7</b> <i>Bit_address</i> <b>Enter</b>  |
| TIMER                                    | <b>Ctrl+F6</b> <i>Timer_number</i> <b>Enter</b><br>Then<br><i>Set_value</i> <b>Enter</b><br>or<br><b>Ctrl+F7</b> <i>Word_address</i> <b>Enter</b>                                 |
| COUNTER                                  | <b>Ctrl+F5</b> <i>Counter_number</i> <b>Enter</b><br>Then<br><i>Set_value</i> <b>Enter</b><br>or<br><b>Ctrl+F7</b> <i>Word_address</i> <b>Enter</b>                               |
| SET (See note.)                          | <b>Shift+F8</b> <i>Bit_address</i> <b>Enter</b>   |
| RESET (See note.)                        | <b>Shift+F9</b> <i>Bit_address</i> <b>Enter</b>   |
| Instructions with function codes         | <b>F10</b> <i>Function_number</i> <b>Enter</b><br>( <i>Operand</i> <b>Enter</b> ) ( <i>Operand</i> <b>Enter</b> )<br>( <i>Operand</i> <b>Enter</b> )                              |
| Differentiated instructions (with @)     | <b>F10</b> <i>Function_number</i> (@, /, or F9) <b>Enter</b><br>( <i>Operand</i> <b>Enter</b> ) ( <i>Operand</i> <b>Enter</b> )<br>( <i>Operand</i> <b>Enter</b> )                |
| Block programming instructions (with <>) | Store program, switch to mnemonic display, then<br><b>Shift+F10</b> <i>Function_number</i> ( <i>Operand</i> )<br>( <i>Operand</i> ) ( <i>Operand</i> ) ( <b>F9</b> ) <b>Enter</b> |

**Note** SET and RESET are enabled only when the Programmable Controller model is set to either the CQM1 or C200HS in the System Setup.

To set the SV externally (i.e., via an input word), switch to the word input display by pressing Control + F7, and then input the word address.

**Entering Function Codes**

- When inputting function codes, include all leading zeroes.
- If the wrong function code is input by mistake, press the F10 Key and then input the function code again.
- The number of operands varies according to the instruction. (For details, refer to the relevant C-series operation manual.)
- For instructions with function codes 04 through 15, 91, 92, 94, and 97, and block programs, input the operand(s) before pressing Enter.
- For instructions with function codes 25 through 29, 38, 39, 44, and 46, use the Right and Down Cursor Keys to move the cursor to the next program line after inputting the operand(s). Enter cannot be used for this purpose.

Special instructions can also be entered in the following way:

- 1, 2, 3...**
1. Pressing the F10 Key or Shift\_F10 Keys. Either "FUN(??)" or "FUN<??>" will be displayed. Then press Enter or input Control + F to display a list of instructions and their function codes.
  2. Move the cursor to select the instruction that is to be entered, and then press Enter. The instruction that is entered will be displayed at the bottom of the screen.

**2-2-4 Entering Bit/Word Addresses and Data**

This section explains how to enter bit addresses, word addresses, and other data.

- The leftmost zeroes of addresses and numbers can be omitted.
- If the wrong address is input by mistake, press the Home Key and then input the address again.
- When creating timer and counter input conditions, press the F4 Key to start again even if the the input symbol is shown in the input display area.
- Constants can be input in BCD with or without a sign.

The following table shows the key sequences for entering bit addresses, word addresses, and data.

| Memory area | Inputting bit addresses  | Inputting word addresses             | Ladder diagram display |
|-------------|--|--------------------------------------|------------------------|
| IR, SR      | <i>Bit_address</i>   | <i>Word_address</i>                  | –                      |
| HR          | <b>Ctrl+F2</b> <i>Bit_address</i>  | <b>Ctrl+F2</b> <i>Word_address</i>   | H                      |
| AR          | <b>Ctrl+F1</b> <i>Bit_address</i>  | <b>Ctrl+F1</b> <i>Word_address</i>   | A                      |
| LR          | <b>Ctrl+F3</b> <i>Bit_address</i>  | <b>Ctrl+F3</b> <i>Word_address</i>   | L                      |
| DM          | –  | <b>Ctrl+F4</b> <i>DM_address</i>     | D                      |
| Indirect DM | –  | <b>Ctrl+F8</b> <i>DM_address</i>     | *D                     |
| Constants   | –  | <b>Ctrl+F10</b> <i>Numeral</i>       | #                      |
| Timer       | Move cursor to existing input (LD, AND, OR, etc.) and then<br><b>Ctrl+F6</b> <i>Timer_number</i>   | <b>Ctrl+F6</b> <i>Timer_number</i>   | T                      |
| Counter     | Move cursor to existing input (LD, AND, OR, etc.) and then<br><b>Ctrl+F5</b> <i>Counter_number</i> | <b>Ctrl+F5</b> <i>Counter_number</i> | C                      |

**Inputting BCD Constants**

To input a constant for an operand, first press Control + F10. At this point hexadecimal input will be possible.

To change the input method, press the F4 Key. Each time the F4 Key is pressed, the input method method will changed in order as follows: BCD without sign to BCD with sign to hexadecimal.

When BCD with sign is selected, the F5 Key serves as the +/- key. Pressing the F5 Key will toggle between "+" and "-."

The displays for F4 will should the next constant input mode. Permissible input ranges are shown below.

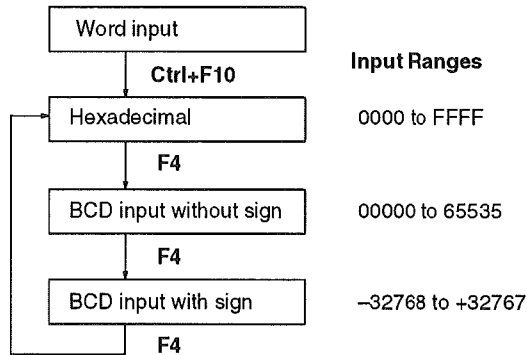

### 2-2-5 Program Input Example

This section provides examples of entering instructions in a ladder-diagram program.

#### Example 1: Entering Input Conditions

- 1, 2, 3... 1. Press the F2 Key to go into the Write mode. The cursor will be displayed at the beginning program line, "00000."

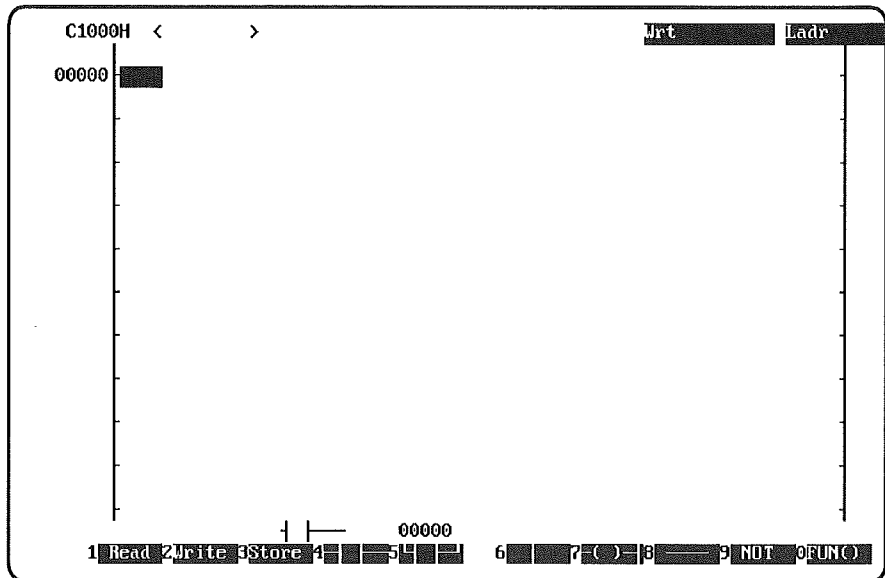

2. Move the cursor to the desired position. If a program is already written at the cursor position, the symbol and bit address will be displayed at the bottom of the screen.
3. Using the function keys, specify the instruction to be input.
4. Input the bit address. Leading zeroes can be omitted. For example, to change the "00000" shown in the screen above to "00001," it is sufficient to simply input "1."

5. Press Enter to write the instruction into the program.

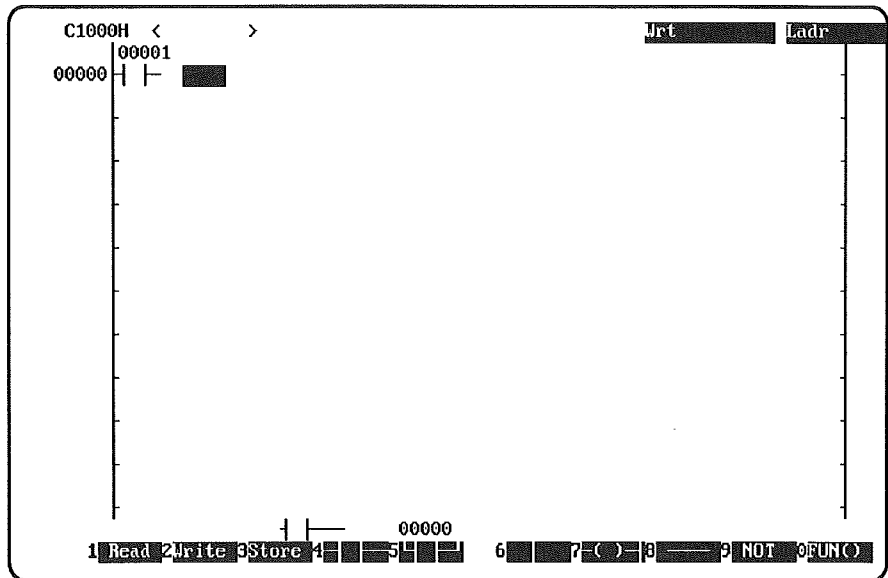

**Note** When entering instructions in for a ladder diagram with comments, align the cursor with the short horizontal lines branching out from the left bus line (the vertical line on the left side of the ladder diagram).

### Example 2: Entering Right-hand Instructions

- 1, 2, 3... 1. Press the F2 Key to go into the Write mode.  
2. Move the cursor to the right of the input condition.

**Note** If there are any breaks in the line between input conditions and right-hand instructions, use the "R:Connect line" operation on the Programming Menu to fill them in.

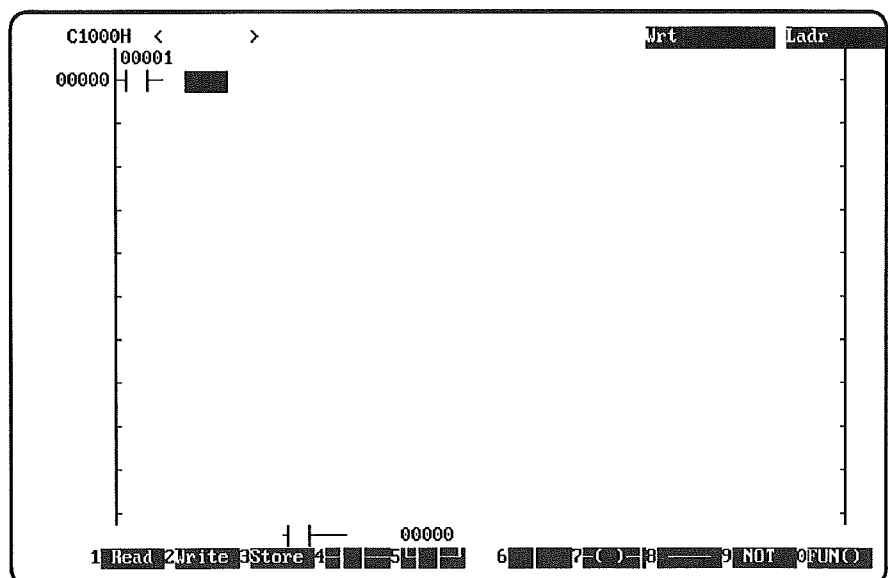

3. Use the function keys to specify the instruction.



4. Input the operand(s) and other information required for the instruction (e.g., function code, set value, operands, etc.).
5. Press Enter to write the new instruction into the program.

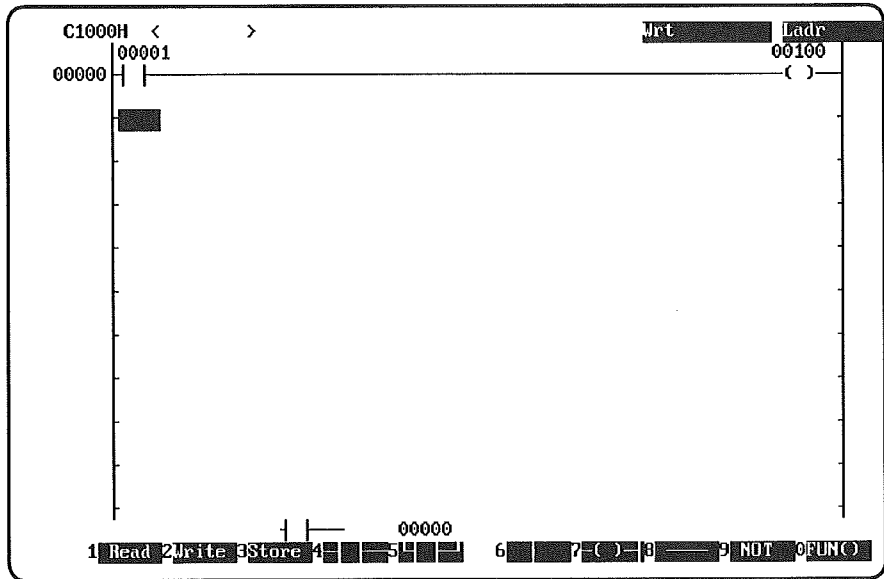

**Example 3: Entering Timer Instructions and Operands**

- 1, 2, 3... 1. Type "1" followed by a carriage return to input the bit address for the first LD instruction. The leading zeros can be omitted.

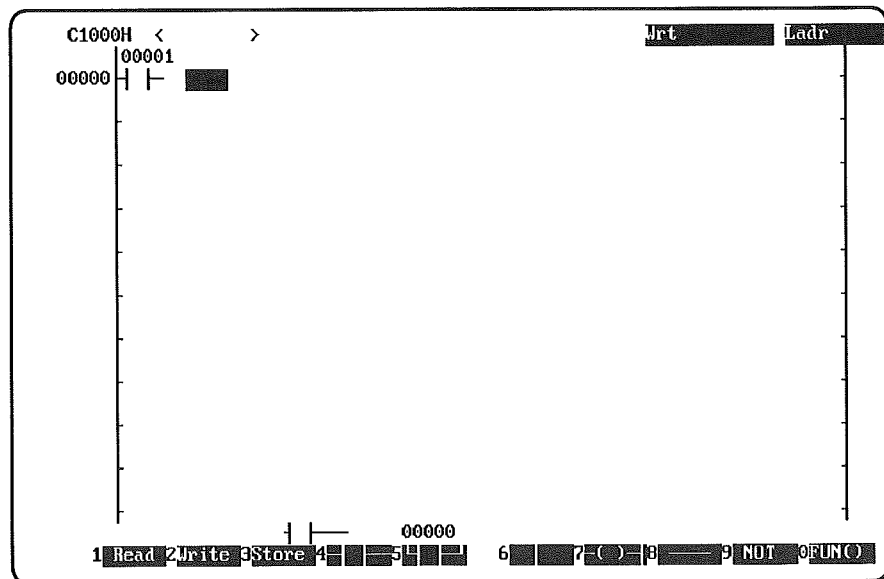

- To enter the timer, input Control+F6 followed by the timer number ("10" in this example) and Enter. Then enter the set value by inputting "100" and Enter.

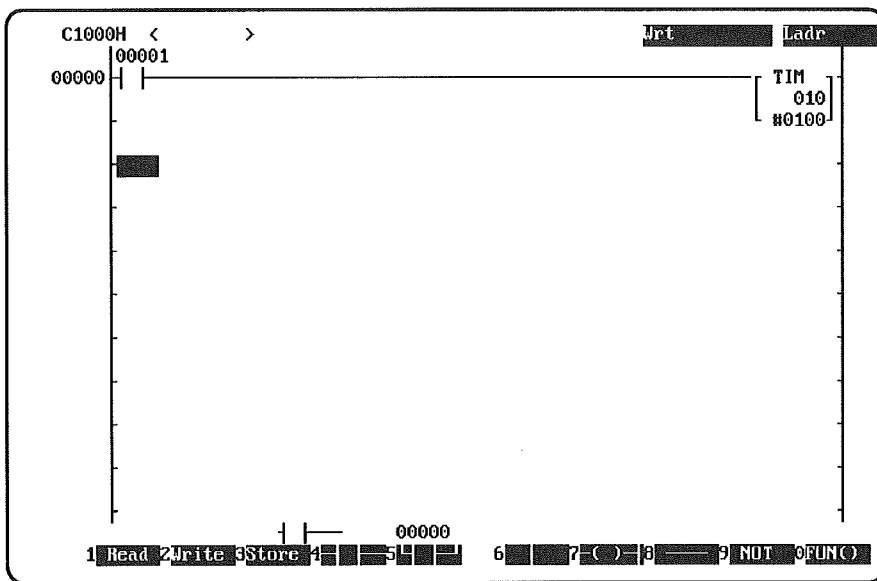

- To write a timer or counter as a bit operand for an input condition, first press F4, then input Control+F6 followed by the number of the timer/counter ("10" in this example).

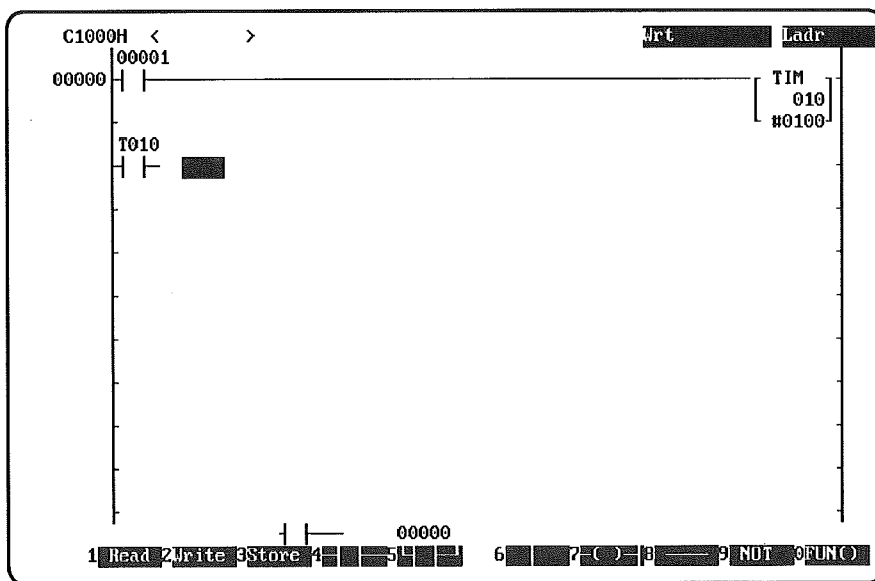

4. To enter an OUTPUT instruction, press F7 followed by Control+F3, 1, and Enter.

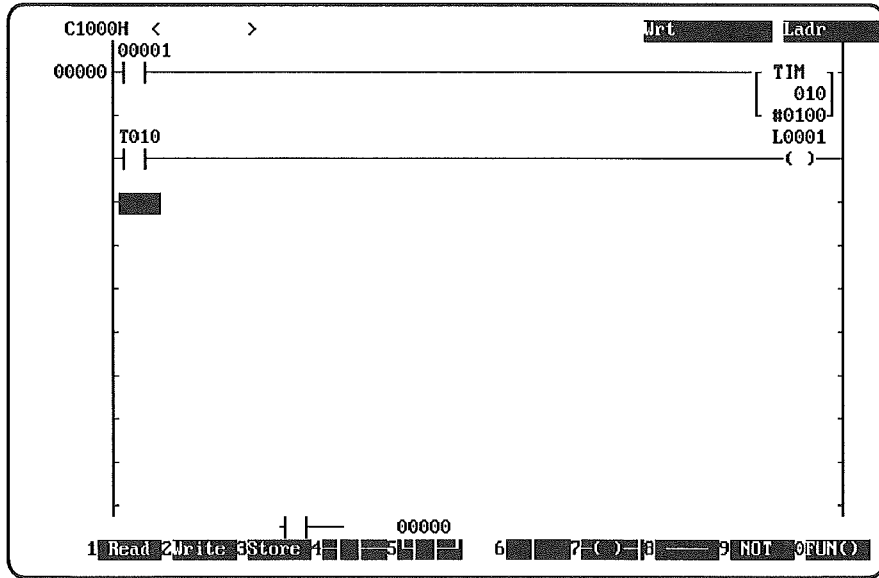

5. Press F3 and Enter to store the program.

### Example 4: Entering Special Instructions

This example will show the procedure for entering the following ladder diagram.

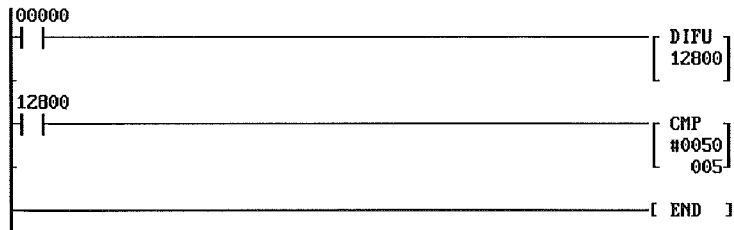

1, 2, 3...

1. Press Enter to enter the first input condition.

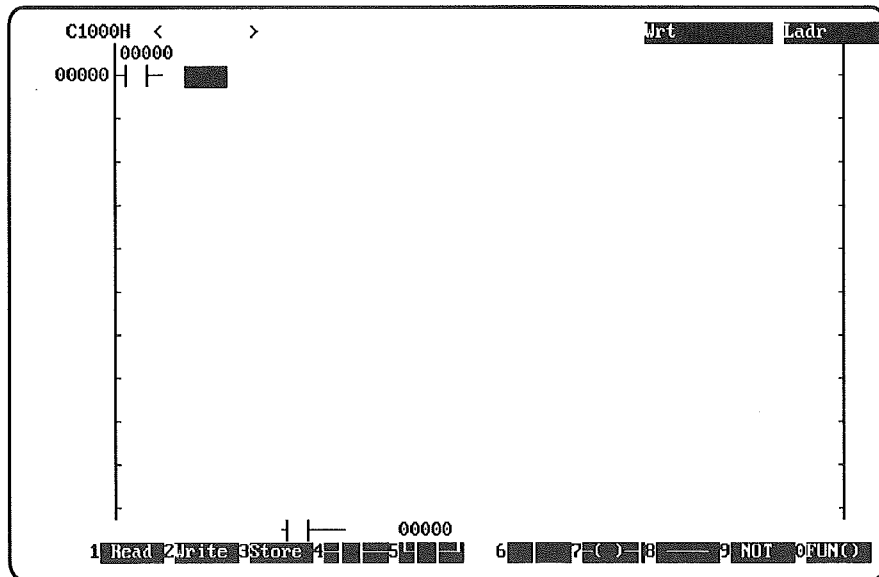

- To enter the DIFU instruction, input F10 followed by "13." Then input "12800" and press Enter. Leading zeroes in function codes must be input.

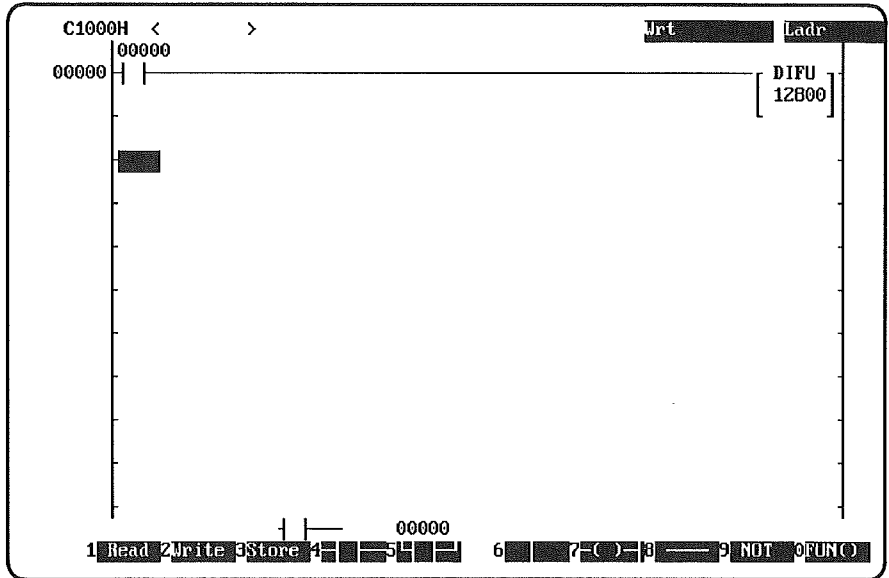

- Input "12800" and press Enter.

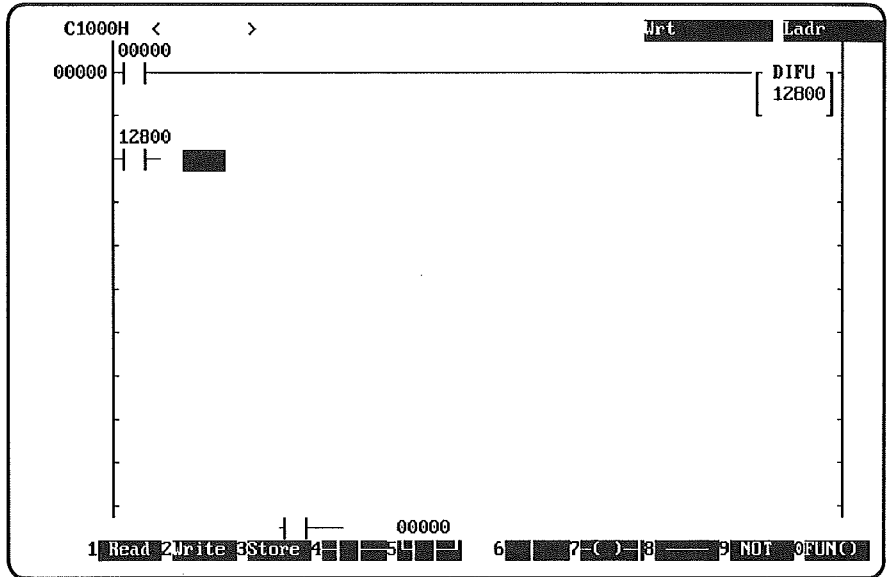

4. Input F10 followed by "20" and press Enter.

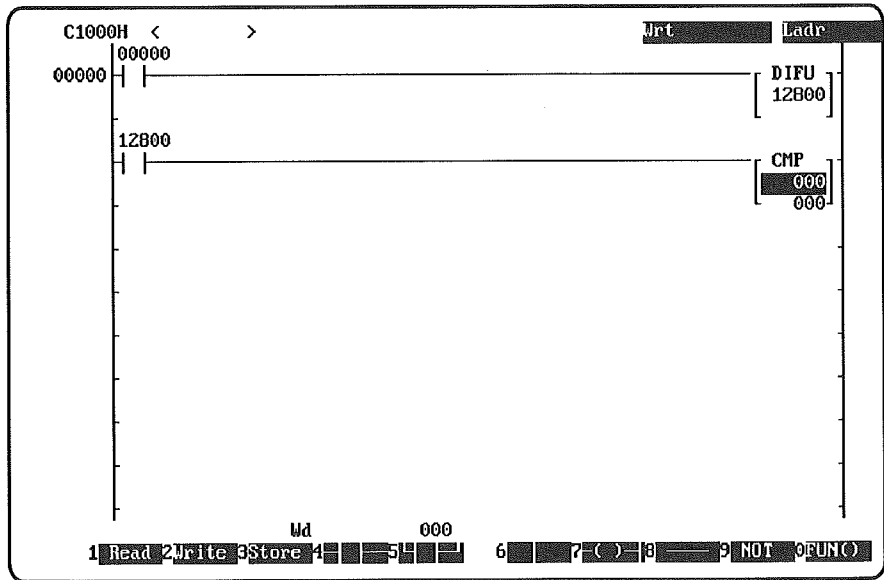

5. To input a constant for any instruction other than TIM/CNT, first input Control+F10. In this example, input Control+F10 followed by "50," and then press Enter. Next input "5" for IR 005 and press Enter.

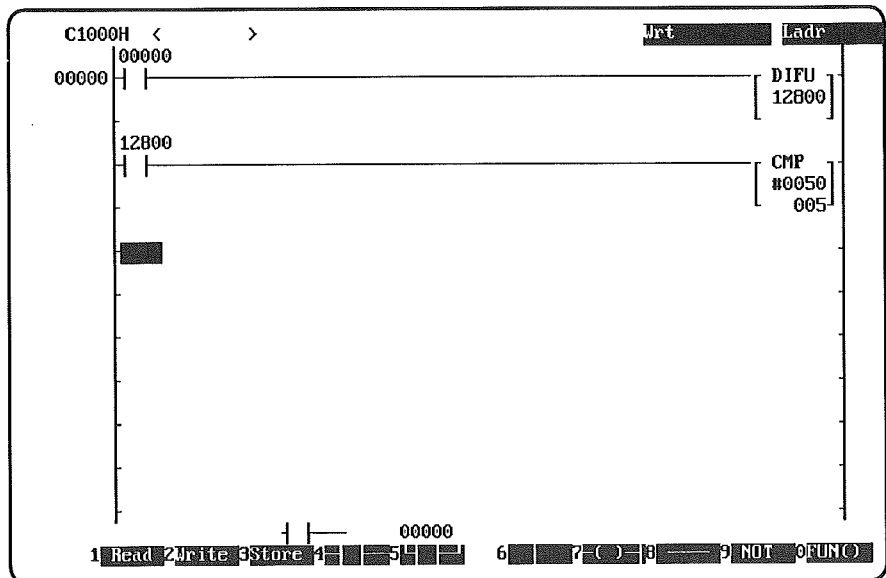

6. To write END (function code 01), input F10 followed by "01" and press Enter.

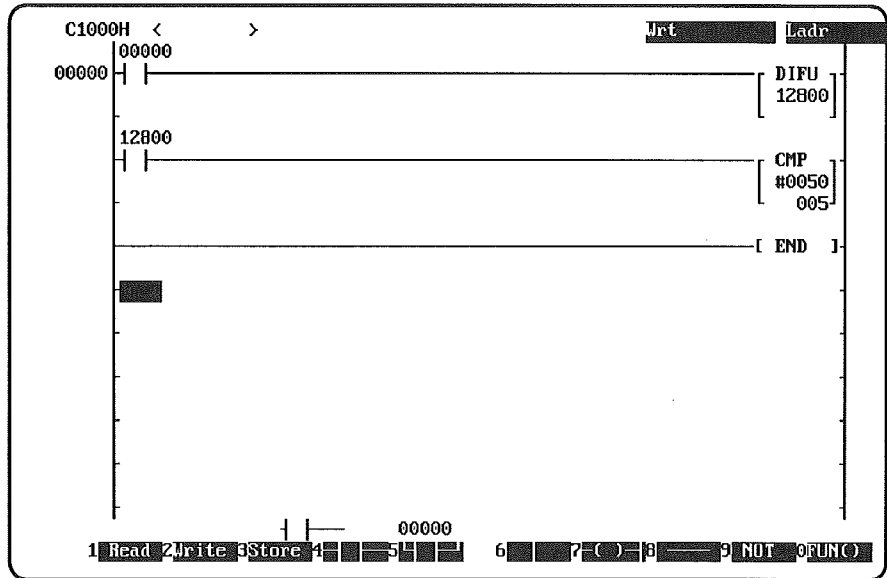

7. Press F3 and Enter to store the program.

### 2-2-6 Writing and Deleting Line Connections

There are two ways to write connecting lines. The first is to write vertical or horizontal lines one cursor movement at a time, and the second is to use the "R:Connect line" operation to write the line by designating the beginning and ending points.

Connections cannot be made for more than 22 instruction lines (the maximum number permitted in an instruction block).

Use the Backspace Key to delete connecting lines one at a time. When the Backspace Key is pressed, the connecting line (the size of one condition) to the left of the cursor will be deleted.

The operations shown in the following table can be used to write and delete vertical and horizontal lines and connections between symbols.

| Connection      | Key sequence  | Function   |
|-----------------|---|--|
| Horizontal line | <b>F8 Enter</b>   | Creates a horizontal line the size of one condition, at the position of the cursor.  |
| Vertical line   | <b>F6 Enter</b>   | Creates a vertical line the size of one instruction line, to the upper left of the cursor.   |
| Connect line    | (Move cursor to start point) <b>End Enter</b> (Move cursor to end point) <b>Enter</b><br>or<br>(Move cursor to start point) <b>Ctrl+L</b> (Move cursor to end point) <b>Enter</b> | Makes long lines to connect two designated points on the screen. The position immediately to the left of the cursor is the start or end point. |

**Note** Use the "R:Connect line" operation to write vertical lines to connect to right-hand instructions. The F6 Key can be used for creating vertical lines only up to within two places to the left a right-side instruction.

**Example 1: Connecting a Single Horizontal Line**

- 1, 2, 3... 1. Move the cursor to the position of the break in the horizontal line.

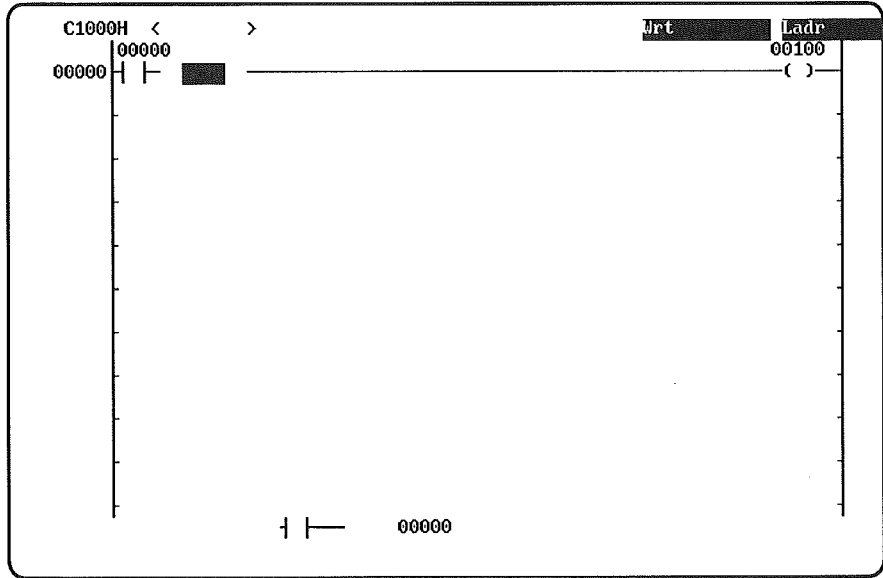

2. Press the F8 Key followed by Enter. The line will be connected.

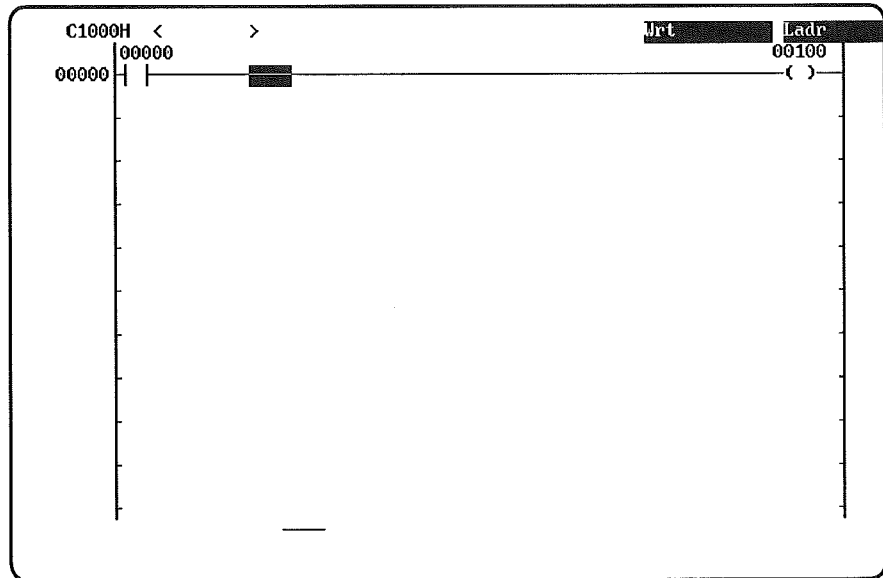

**Example 2: Connecting a Single Vertical Line**

- 1, 2, 3... 1. Move the cursor to the lower right of the position where the vertical line is to be written. (In this example, an OR LD instruction is being created.)

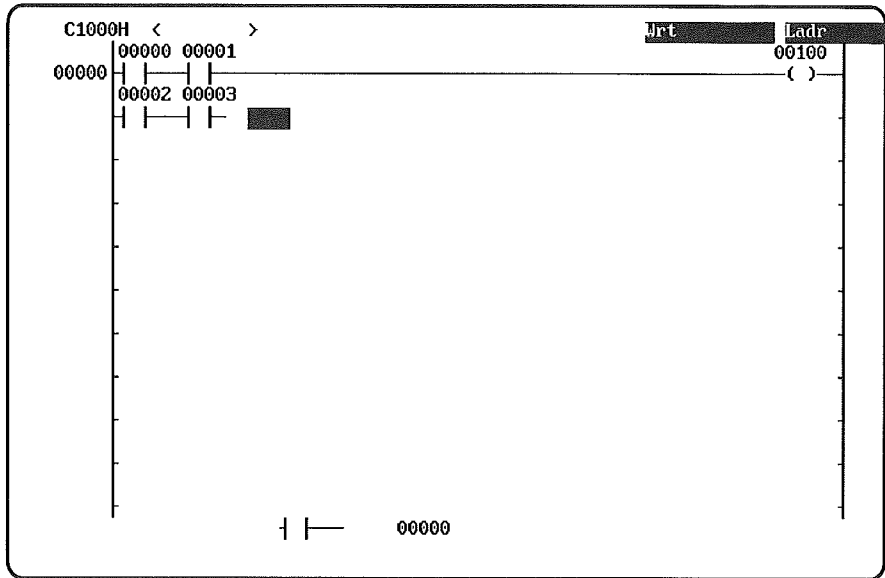

2. Press the F6 Key followed by Enter. The line will be connected.

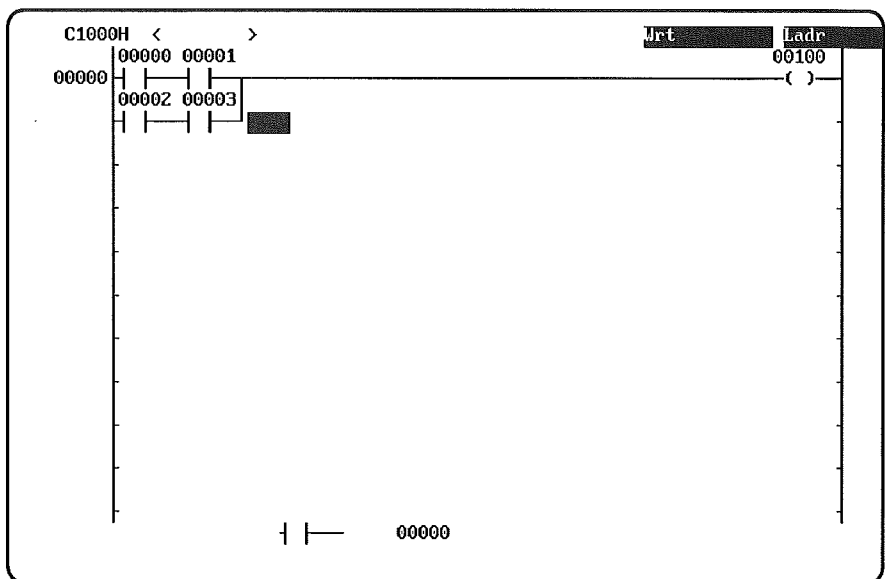



**Example 3: Connecting Parallel OUTPUT Instructions**

- 1, 2, 3... 1. Move the cursor to the left of the lower OUTPUT instruction.

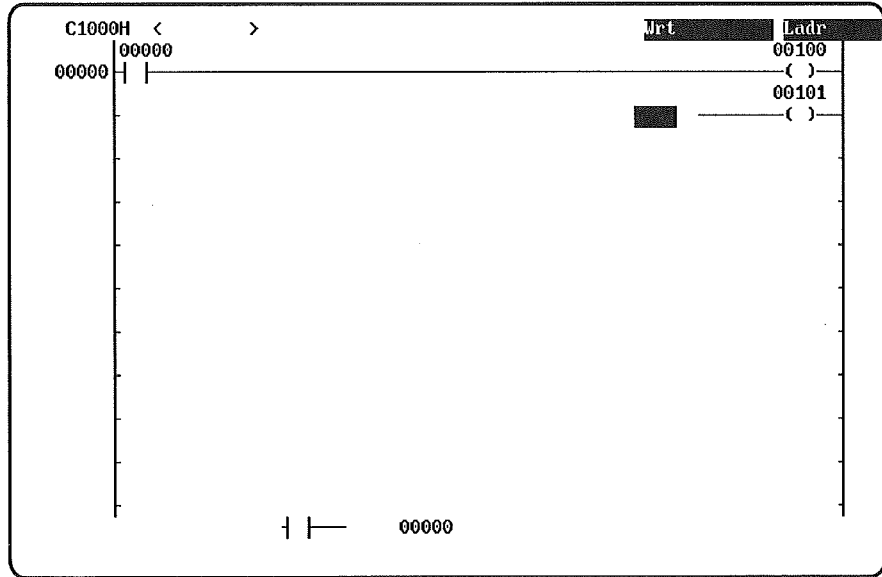

2. To connect the vertical line, press the F6 Key followed by Enter. (This operation cannot be used, however, to create a vertical line immediately to the left of an output instruction. To do that, use the "R:Connect line" operation.)

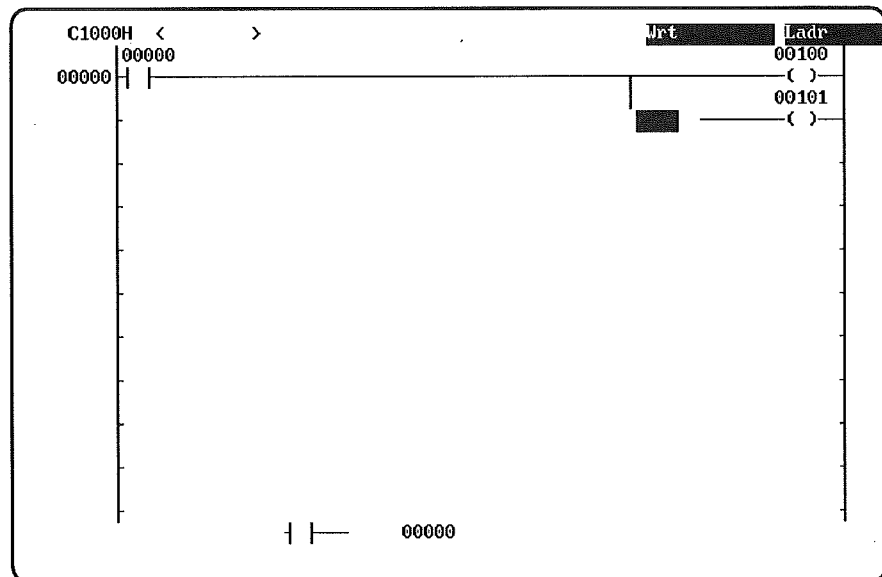

3. To connect the horizontal line, press the F8 Key followed by Enter.

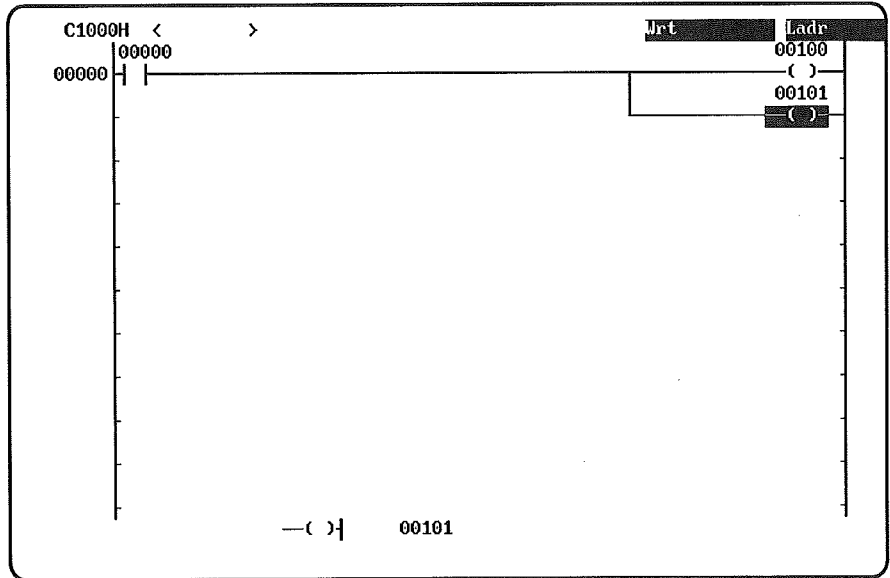

### Example 4: Using Line Connection Operations

“R:Connect line” can be used to connect long horizontal lines, to connect one instruction line to another, and to connect between multiple input conditions.

#### Connecting Long Horizontal Lines

- 1, 2, 3... 1. Move the cursor to the start point and press the End Key followed by Enter. Alternatively, input Control+L to go into the line connect mode.

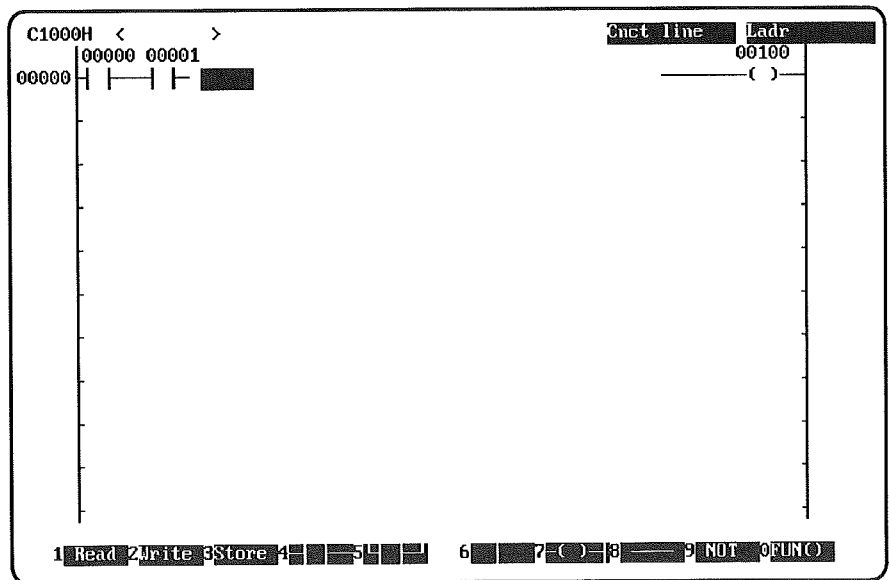

2. Move the cursor to the end point.

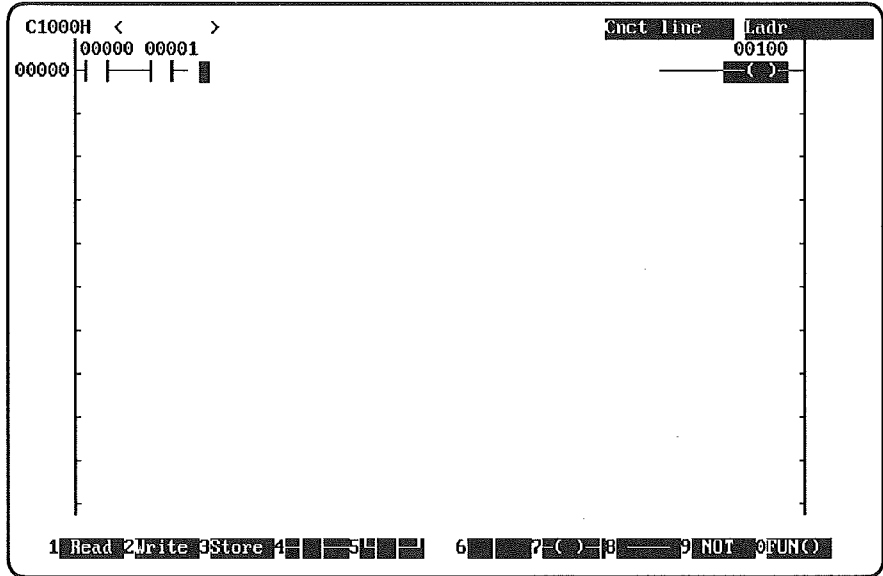

3. Press Enter. The line will then be connected.

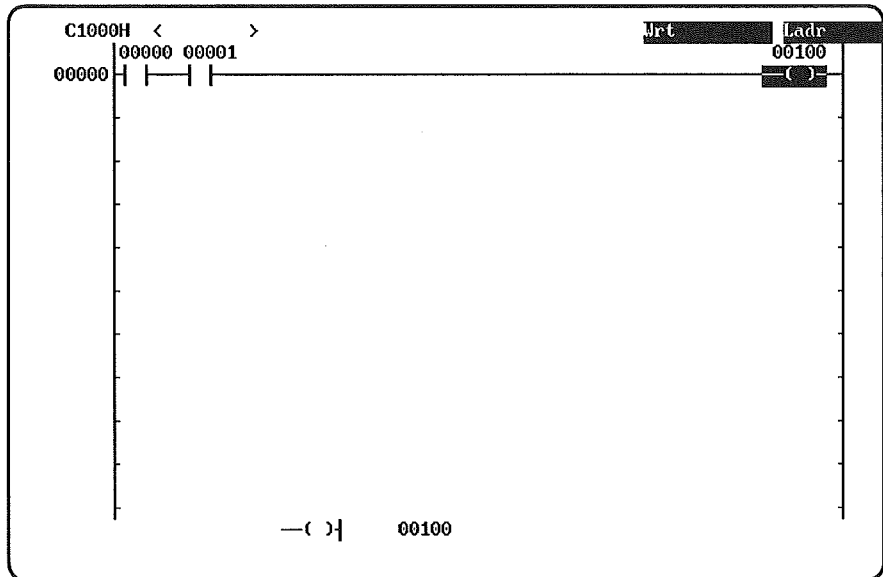

Creating Long Connecting Lines

- 1, 2, 3... 1. Move the cursor to the start point and press the End Key followed by Enter. Alternatively, input Control+L to go into the line connect mode.

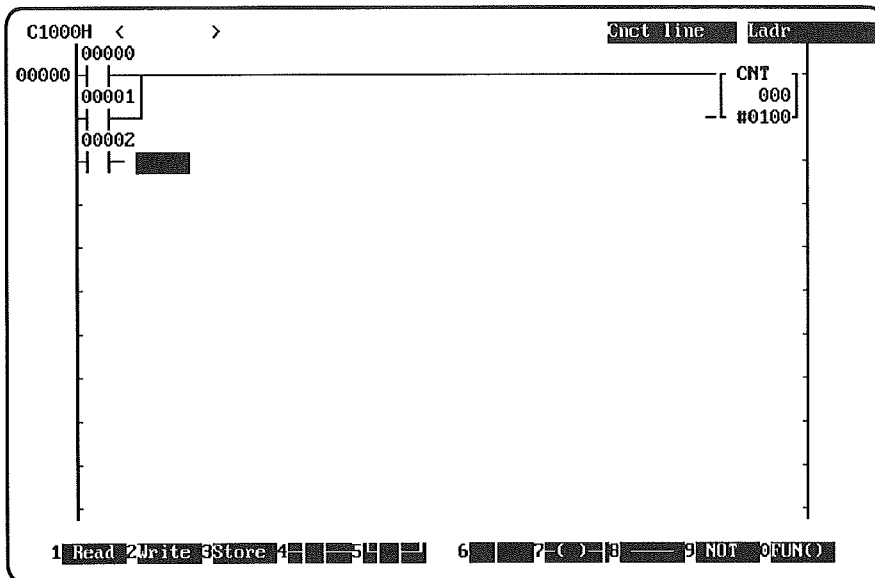

2. Move the cursor to the end point.

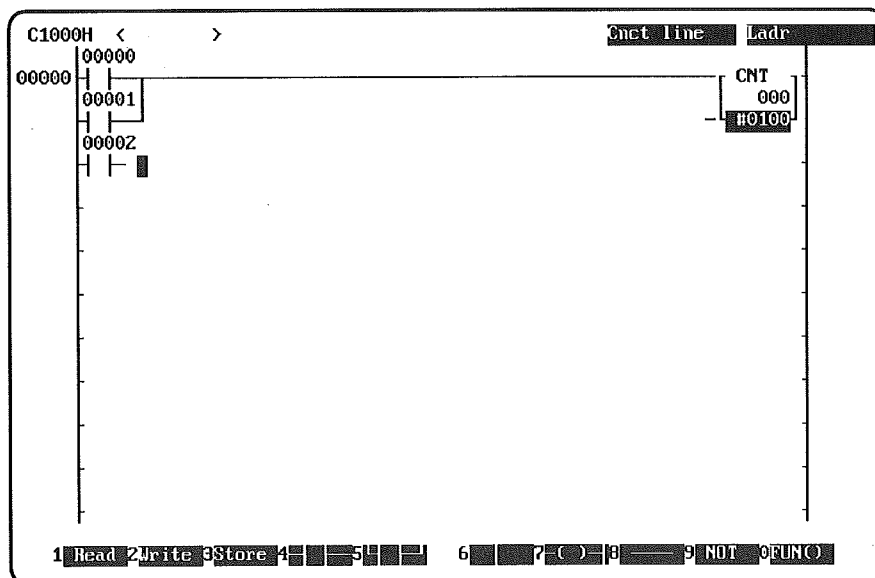

3. Press Enter. The line will then be connected.

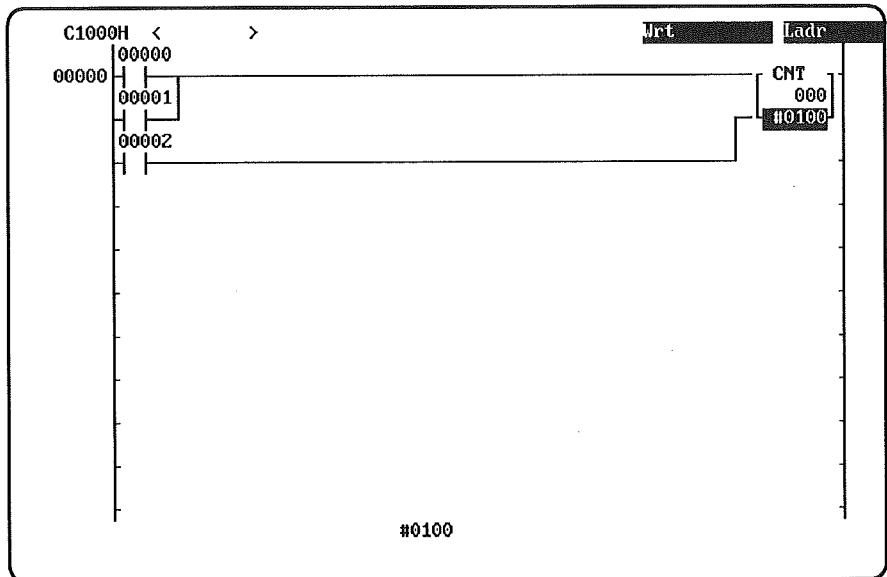

**Connecting Multiple Inputs**

- 1, 2, 3... 1. Move the cursor to the start point and press the End Key followed by Enter. Alternatively, input Control+L to go into the line connect mode.

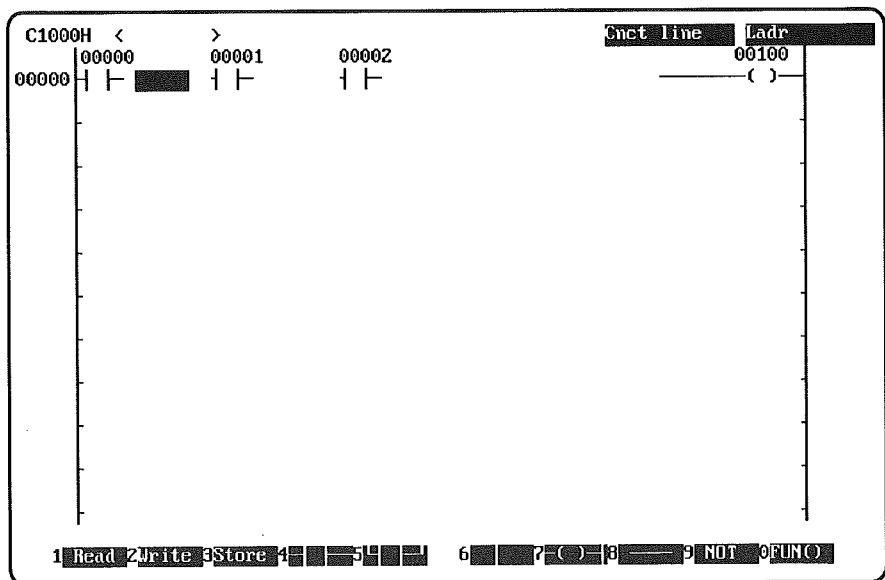

2. Move the cursor to the end point.

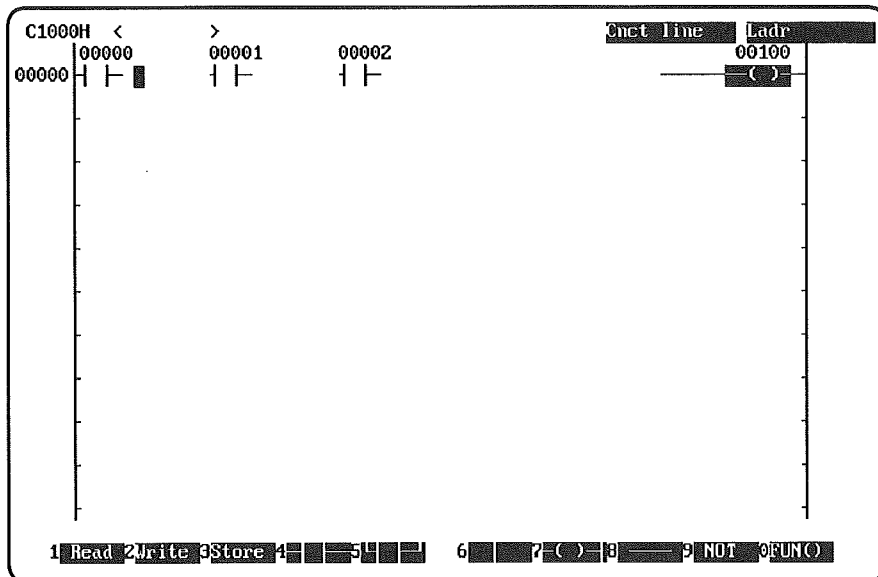

3. Press Enter. All of the inputs will be connected at once.

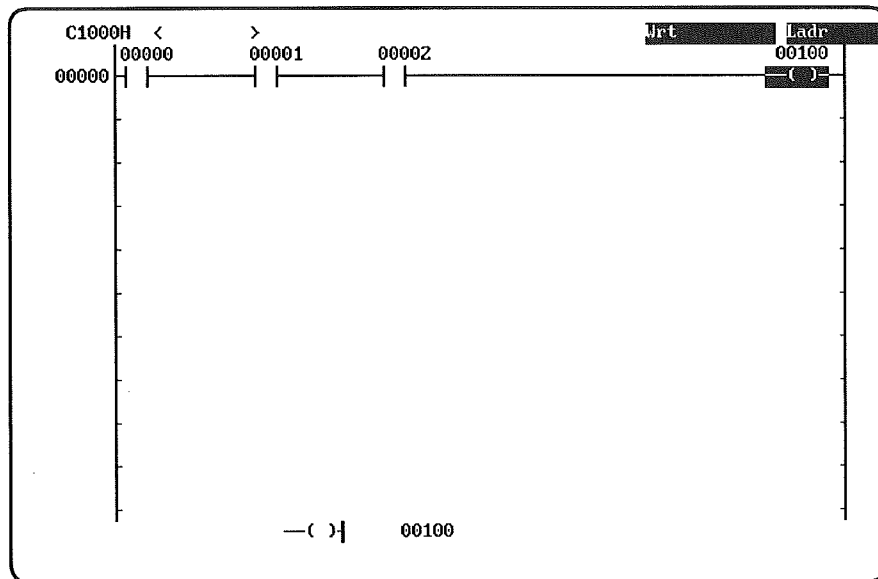

Connecting Parallel OUTPUT Instructions

- 1, 2, 3... 1. Move the cursor to the first OUTPUT instruction that is to be connected.

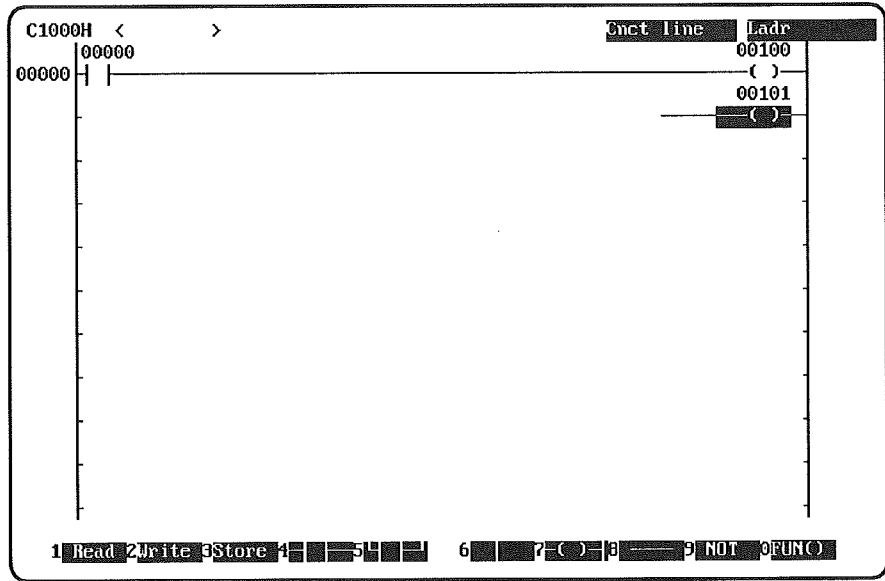

2. Press the End Key followed by Enter. Alternatively, input Control+L to go into the line connect mode.  
3. Move the cursor to the other OUTPUT instruction.

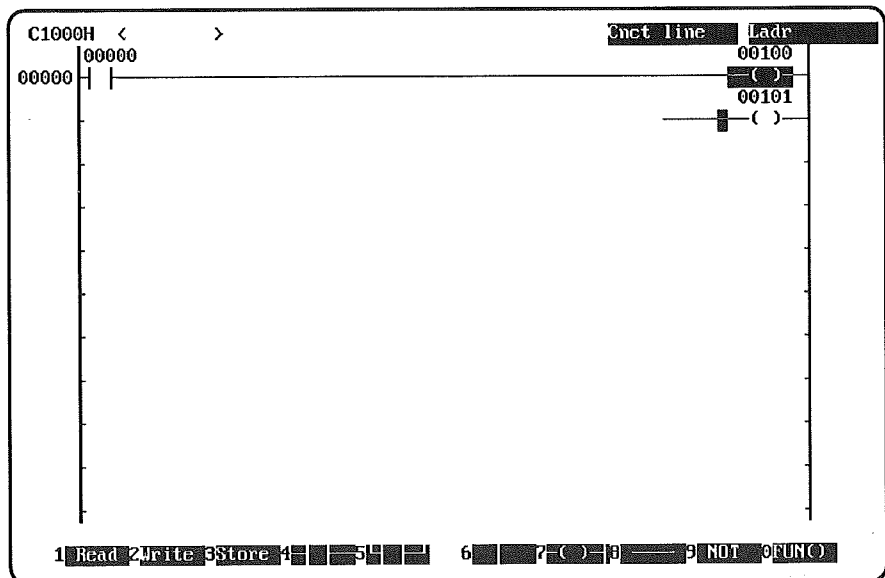

4. Press Enter. The connection will be made between the outputs.

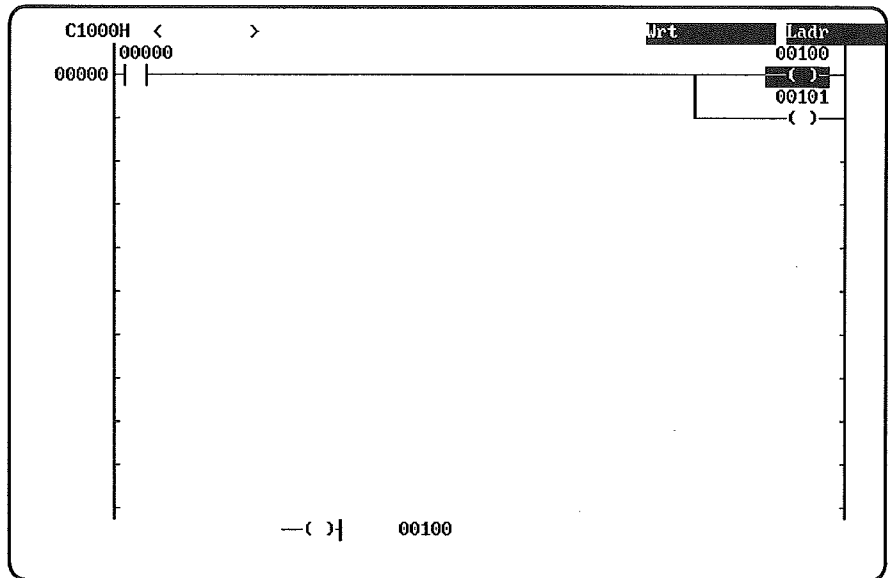

### 2-2-7 Continuing Instruction Lines

The continue operation is used to continue an instruction line when the maximum number of input conditions already exists on an instruction line.

Up to 9 input conditions and 1 right-hand instruction can be connected in a single line. If all required conditions and instructions cannot be written in a single line, use the continue operation to link it to the next line.

The following diagram illustrates how **not** to connect multiple conditions and instructions in a single line. Connecting lines with the "R:Connect line" operation, as shown here, will result in a program error. Use the continue operation instead.

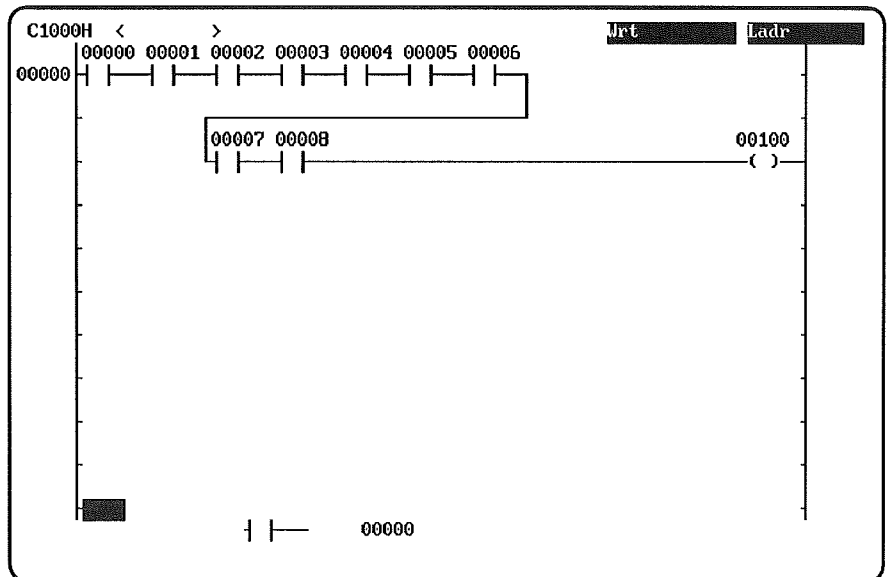

#### Procedure

The procedure outlined below is an example of the correct way to construct a ladder diagram with more than the maximum number of input conditions on a single line.



- 1, 2, 3... 1. Move the cursor to the 10th column (i.e., the extreme right) of the instruction line. The continue operation can only be executed from this position.

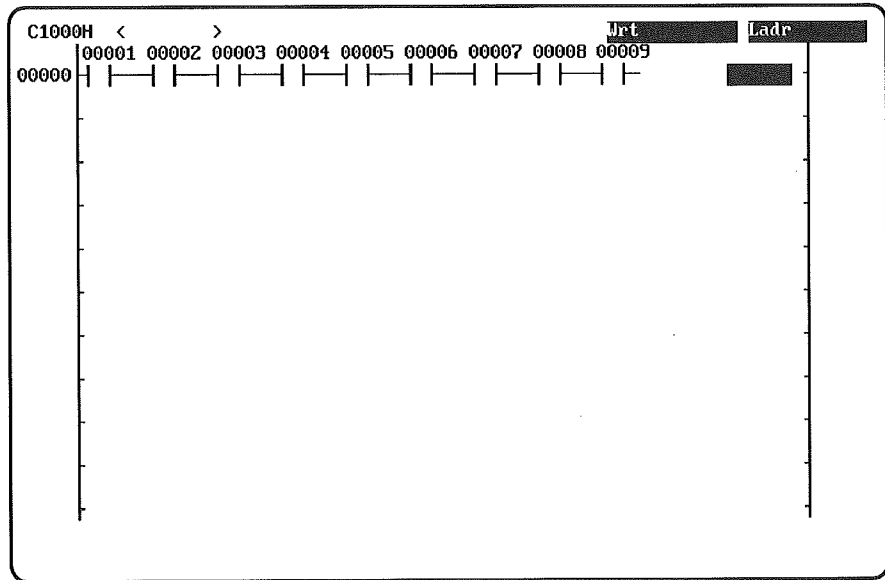

2. Up to this point, no symbol should be displayed in the 10th column. Press the F4 Key and then enter the input condition operand (IR 010, in this example). Then press Enter. The connection symbols will then be displayed and the conditions in the 9th and 10th columns will be displayed on the next line.

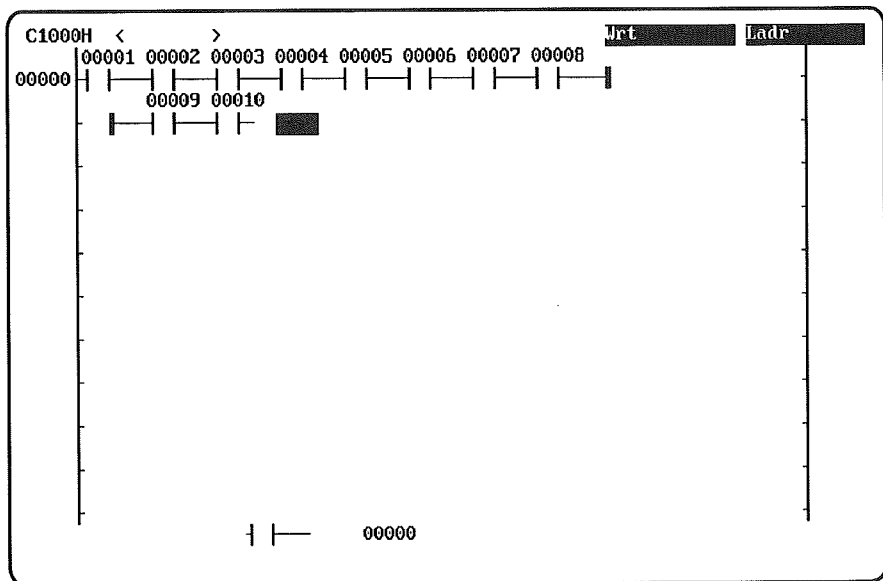

### 2-2-8 Editing Ladder Diagrams

The procedure for editing a ladder program is described below. Ladder programs can be edited either in the Write or Insert/Delete modes. Do not forget to store the edited program.

| Operation                                   | Keys used   |
|---|---|
| Inserting and deleting symbols              | <b>Insert</b> (then input condition) and <b>Backspace</b> |
| Inserting and deleting empty columns        | <b>Insert</b> and <b>Delete</b>                           |
| Inserting and deleting empty rows           | <b>PageUp</b> and <b>PageDown</b>                         |
| Deleting instruction blocks                 | <b>Shift+Home</b>   |
| Deleting input data (bit or word addresses) | <b>Home</b>   |
| Interchanging NC and NO conditions          | <b>/</b> or <b>F9 Enter</b>                               |

See 2-6 *Editing Instruction Blocks* for details on moving, copying, and deleting instruction blocks.

See 5-3 *Globally Changing Addresses* for globally changing bit or word addresses in the entire program in a single operation.

The same editing functions can be accomplished in the Write mode as in the Insert or Delete modes, but the Insert and Delete modes are especially handy for carrying out the operations shown in the following table. For most other operations, it is generally better to use the Write mode in order to save having to change modes back and forth by means of Shift+F1 and Shift+F2.

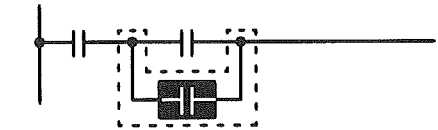
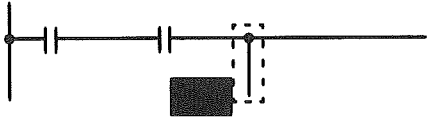
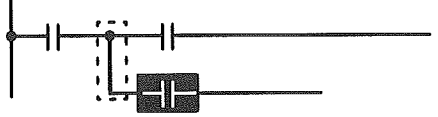
| Operation                      | Mode        | Process   |
|--------------------------------|-------------|---|
| Continuously inserting symbols | Insert mode | There is no need to repeatedly press the Insert Key to insert symbols.  |
| Deleting OR statements         | Delete mode |  <p>Simply press the F5 Key and Enter to delete the entire portion indicated in dotted lines.</p>  |
|                                | Write mode  | It is necessary to delete the contact and the two vertical lines separately.  |
| Deleting vertical lines        | Delete mode |  <p>The vertical connecting line can be deleted by pressing the F5 and Enter Keys with the cursor positioned before (i.e., to the left of) the line. This is especially useful for deleting vertical lines just before instructions. (Those lines cannot be deleted in Write mode.)</p> |
|                                | Write mode  |  <p>The vertical connecting line can be deleted by pressing the F6 and Backspace Keys with the cursor positioned after (i.e., to the right of) the line.</p>  |

**⚠ Caution** Be sure to store the ladder program again after it has been edited. If it is not stored after editing, the edited contents will not be saved.

## Editing in Write Mode

| Operation   | Key used  | Comments  |
|---|---|---|
| Deleting instruction block (up to 22 instruction lines of the ladder diagram) | <b>Shift+Home</b>   | —   |
| Clearing input data from input display area                                   | Re-input the instruction  | —   |
| Clearing bit and word addresses from input area                               | Home  | —   |
| Inserting a symbol  | Move cursor <b>Ins</b> Insert condition <b>Bit_address Enter</b>  | The cursor position goes blank and a symbol is entered.   |
| Deleting the symbol to left of cursor   | Deleting a condition, right-hand instruction, or horizontal line:<br>Move cursor <b>Backspace</b><br>Deleting a vertical line:<br>Move cursor <b>F6 Backspace</b> | <ul style="list-style-type: none"> <li>• The symbol to the left of the cursor will be deleted. To delete a right-hand instruction, place the cursor on the far left of the same instruction line and press the Backspace Key.</li> <li>• For block comments, all four rows at the cursor will be completely deleted.</li> <li>• After making the deletion, edit as required to complete the program.</li> </ul>   |
| Creating a blank column   | Move cursor <b>Insert</b>   | <ul style="list-style-type: none"> <li>• A blank column is created at the cursor position.</li> <li>• If an instruction block contains more than one line, a blank column is created at the cursor position in every line of the instruction block.</li> <li>• A blank column cannot be created if there are nine input symbols in a single line. In that case, first use the continue operation to change to a continuing instruction line, and then create the blank column.</li> </ul> |
| Deleting a blank column   | Move cursor <b>Delete</b>   | <ul style="list-style-type: none"> <li>• The blank column at the cursor position is deleted.</li> <li>• If an instruction block contains more than one line, the blank column is deleted at the cursor position in every line of the instruction block at the cursor position. The delete operation will be cancelled unless a blank column exists at the cursor position in every line of the instruction block.</li> </ul>  |
| Creating a blank line   | Move cursor <b>PgUp</b>   | <ul style="list-style-type: none"> <li>• A blank line is created at the cursor position.</li> <li>• No blank line can be created if the program already contains 22 instruction lines.</li> <li>• No blank line can be created if there is an instruction in the line where the cursor is positioned. A blank line can be created, however, at the reset input position for CNT, CNTR, SFT, and KEEP instructions.</li> </ul>   |
| Deleting a blank line   | Move cursor <b>PgDn</b>   | The blank line at the cursor position is deleted. The deleted operation will be cancelled if the line at the cursor position contains ladder elements, including any instructions.  |
| Reversing NO and NC conditions  | Move cursor <b>/ (or F9) Enter</b>  | The condition at the cursor will change from normally open to normally closed or from normally closed to normally open.   |

**Editing Examples**

**Changing a Bit Address** In this example, the input address is changed from IR 00111 to IR 00300.

- 1, 2, 3... 1. Move the cursor to the input symbol for the address that is to be changed.

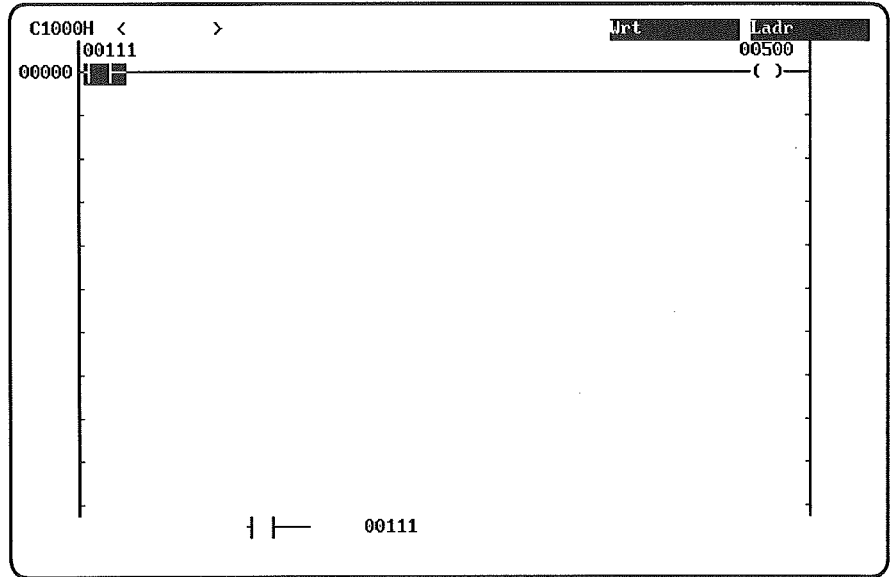

2. Input the new address (300 in this example), and press Enter. The address will be changed, and the new address will be displayed.

**Inserting a Symbol**

In this example, another input condition (bit address: IR 00001) is inserted into the program.

- 1, 2, 3... 1. Move the cursor to the position where the symbol is to be inserted, and press the Insert Key.

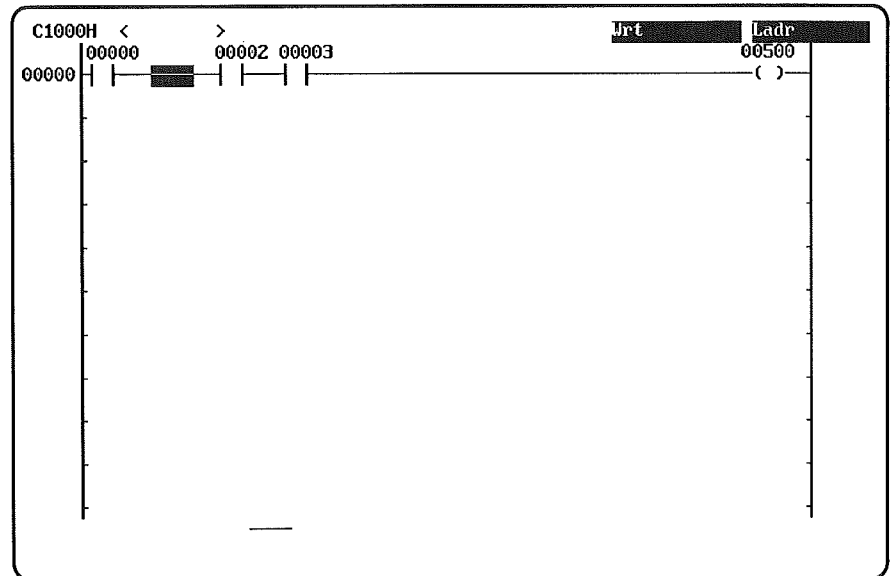

2. Input the symbol that is to be inserted (F4 followed by 1, in this example), and press Enter.

**Deleting a Vertical Connection**

In this example, the vertical connection in the OR LD instruction is deleted from the program.

- 1, 2, 3... 1. Move the cursor to the right of the vertical connecting line that is to be deleted.

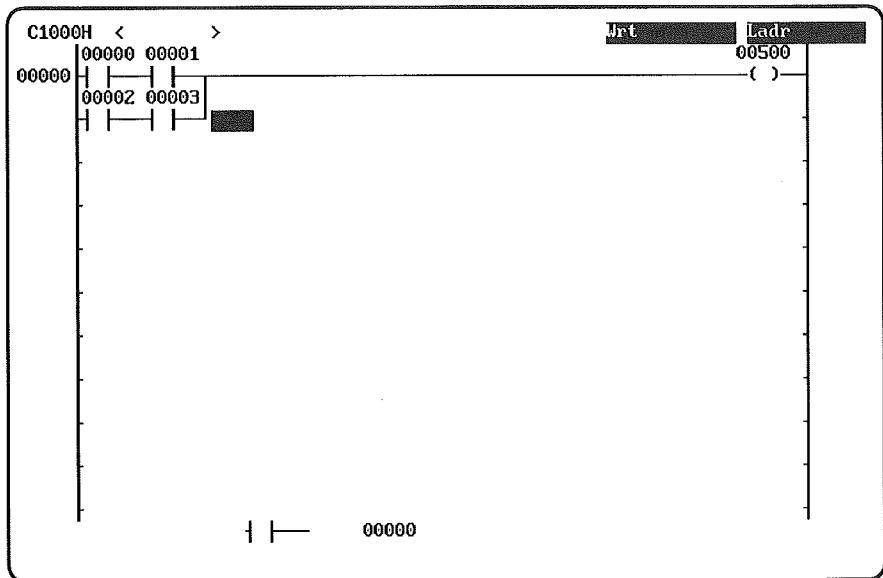

2. Press the F6 Key to designate the vertical connection, and then press the Backspace Key.

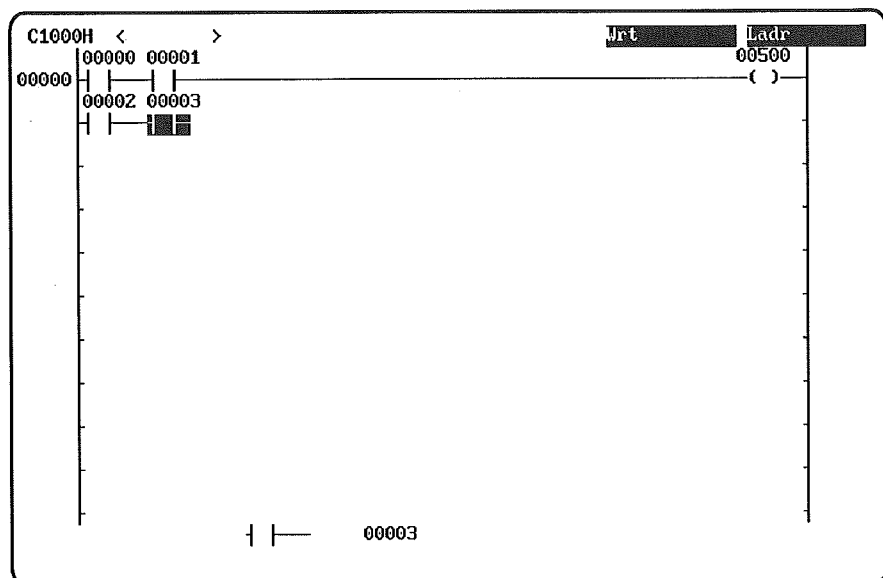

**Deleting a Symbol to the Left of the Cursor**

In this example, the symbol to the left of the cursor is deleted from the program.

- 1, 2, 3... 1. Move the cursor to the right of the symbol that is to be deleted.

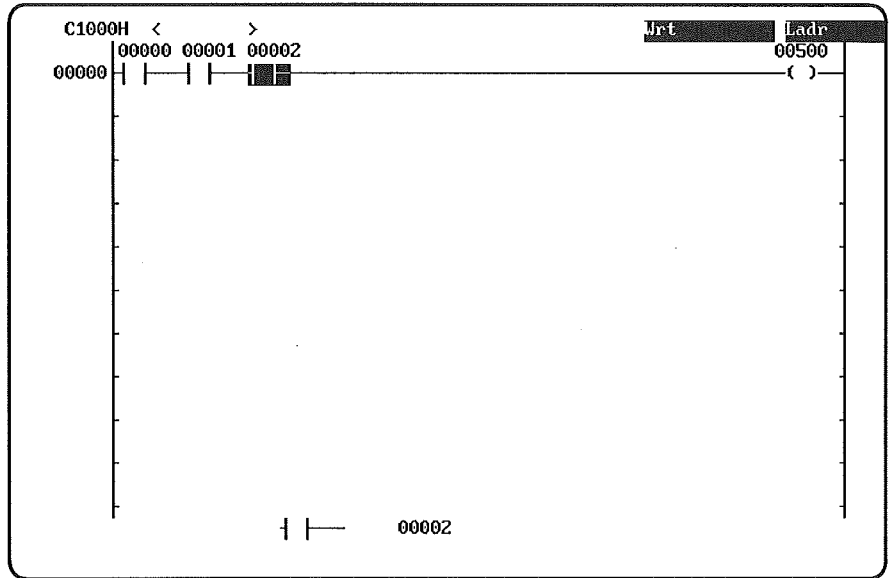

2. Press the Backspace Key. The symbol will be deleted and a blank space will be created in its place.

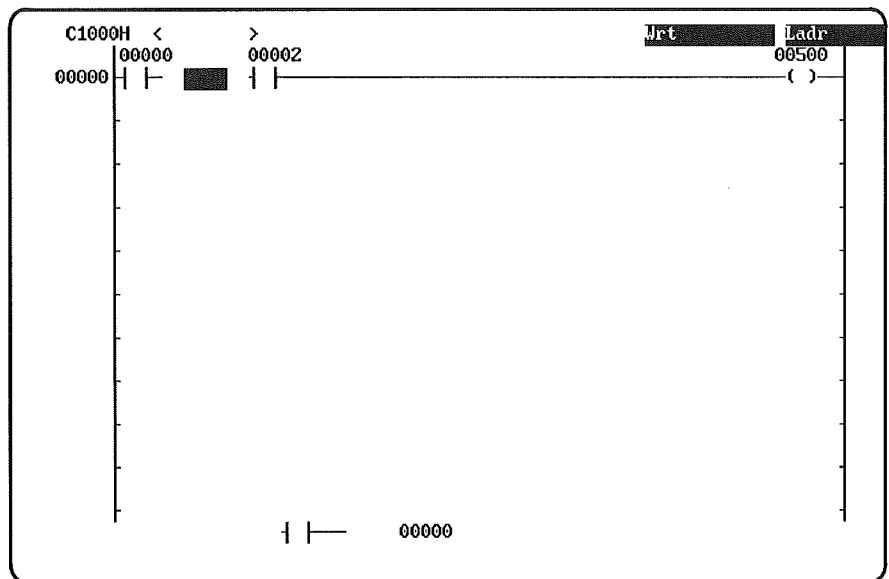

**Deleting the Reset Input Line for a CNT Instruction**

In this example, the reset input line for a CNT instruction is deleted. This operation cannot be carried out by means of the procedure described above for deleting a vertical connection.

- 1, 2, 3... 1. Move the cursor to the first line of the CNT instruction. The reset input line is deleted by deleting the CNT instruction.

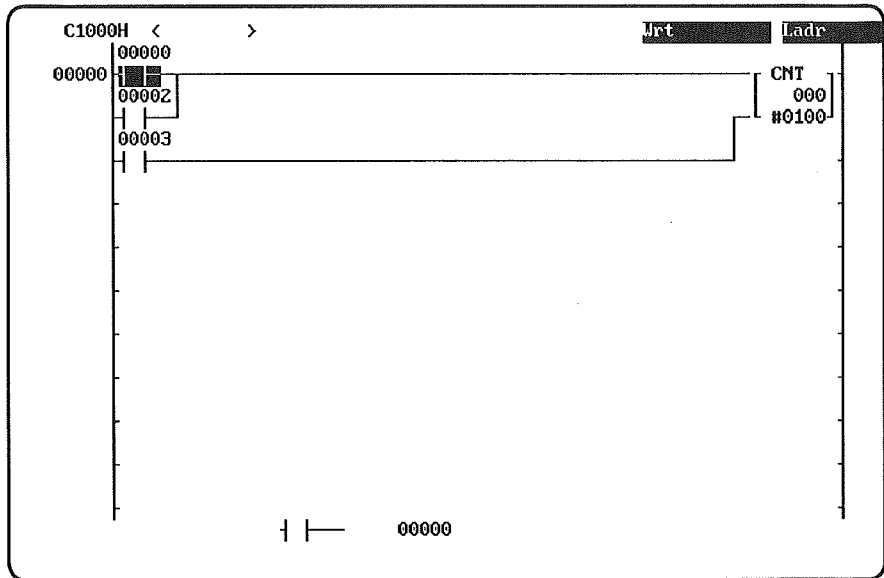

- 2. Press the Backspace Key. The CNT instruction will be deleted and a blank space will be created in its place.

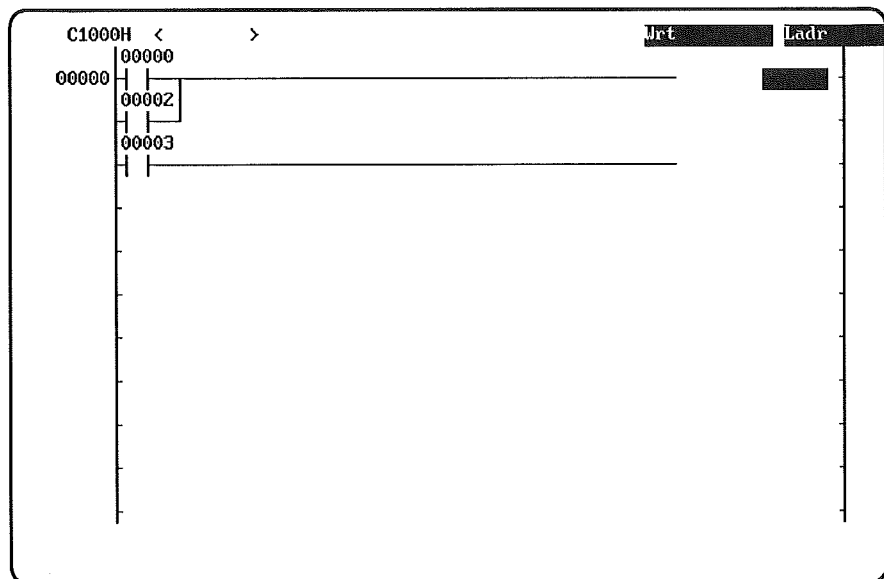

Creating and Deleting a Blank Column

- 1, 2, 3... 1. To create a blank column, move the cursor to the right of the column that is to be created. To delete the column, move the cursor to the column.

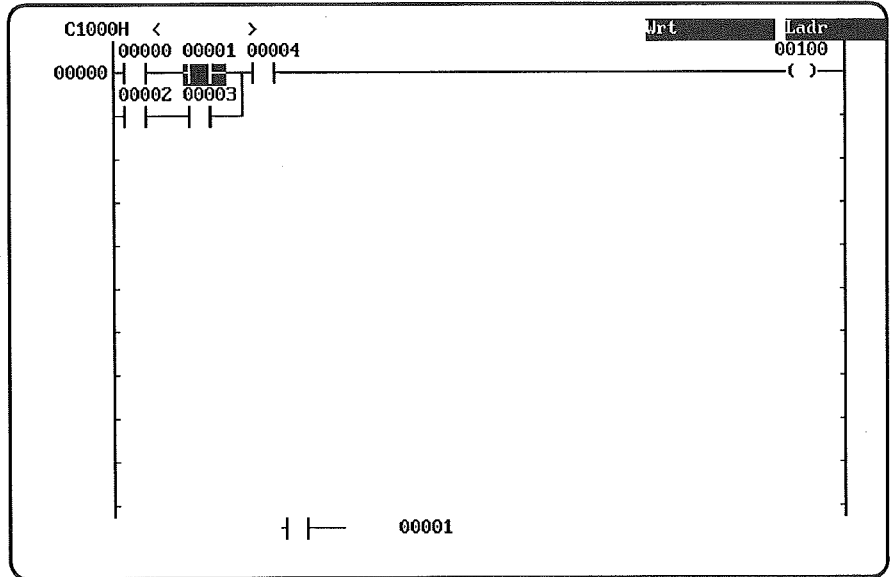

2. To create a blank column, press the Insert Key. To delete the column, press the Delete Key.

Insert Key (Create)

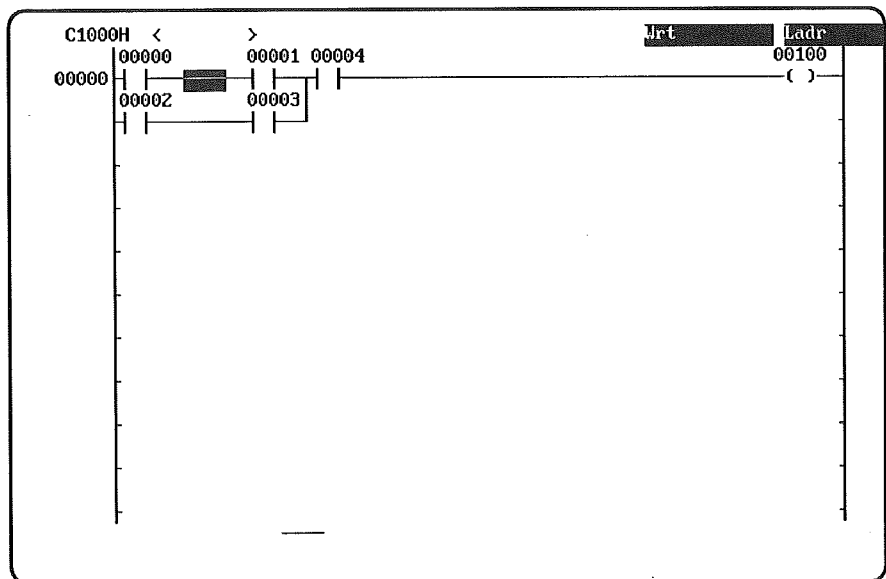



Delete Key (Delete)

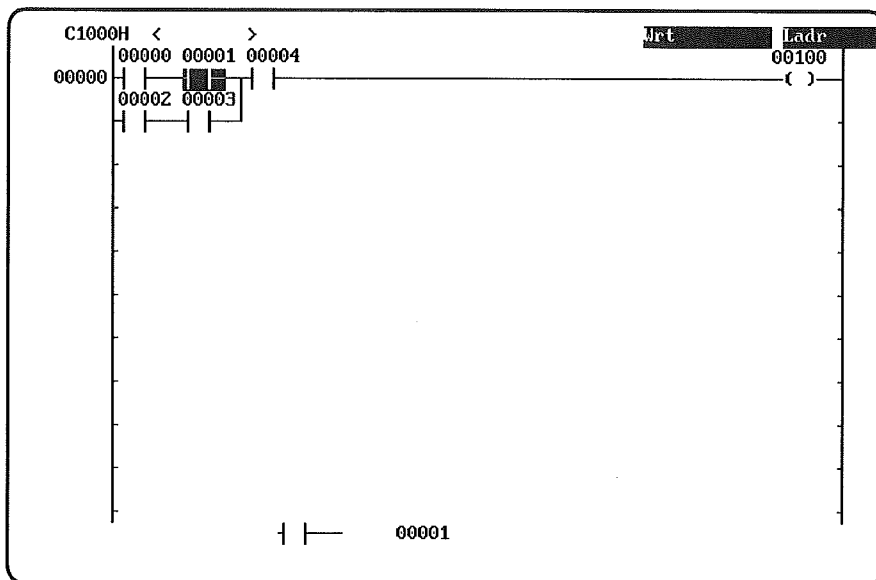

Creating and Deleting a Blank Line

- 1, 2, 3... 1. To create a blank line, move the cursor to the line below the line that is to be created. To delete the line, move the cursor to the line.

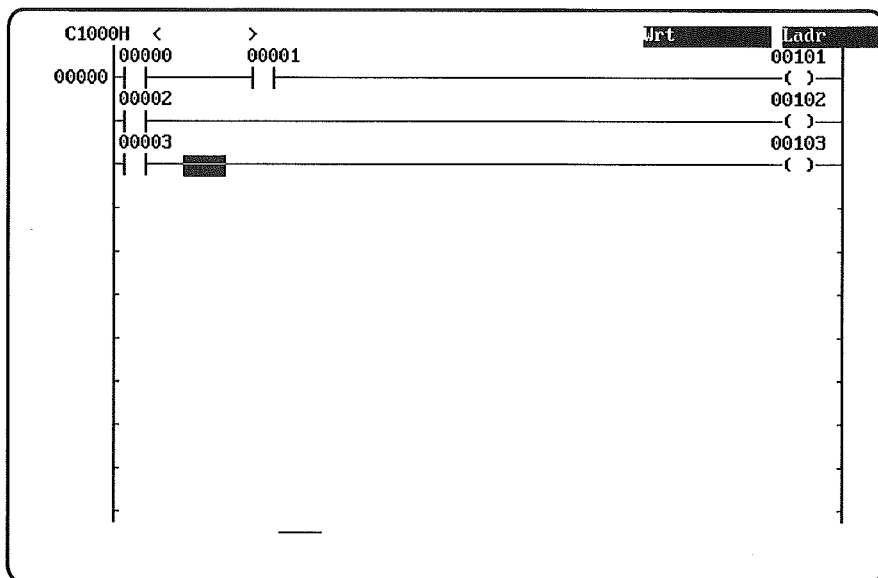

2. To create a blank line, press the PgUp Key. To delete the line, press the PgDn Key.

PgUp Key (Create)

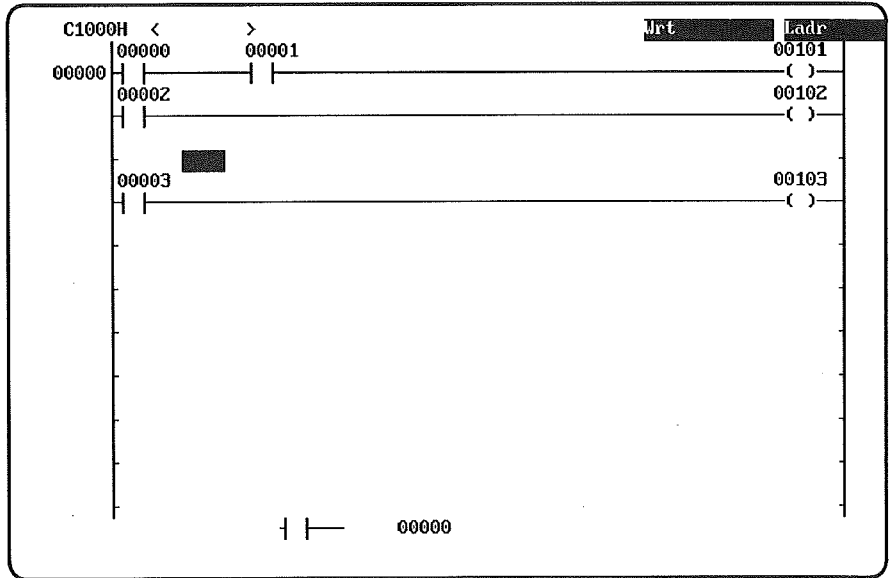

PgDn Key (Delete)

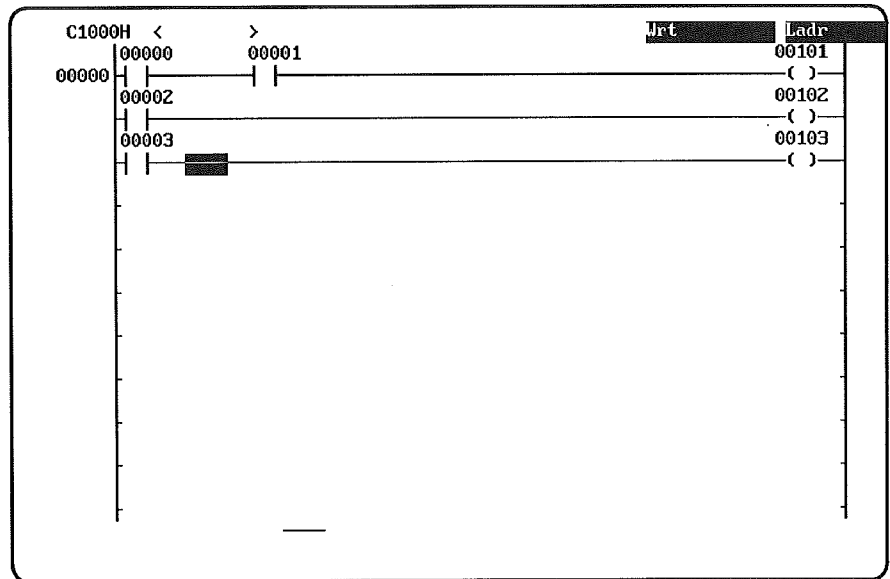

Creating a Blank Line for a CNT, CNTR, SFT, or KEEP Instruction

- 1, 2, 3... 1. Move the cursor to the line of the last operand in the instruction.

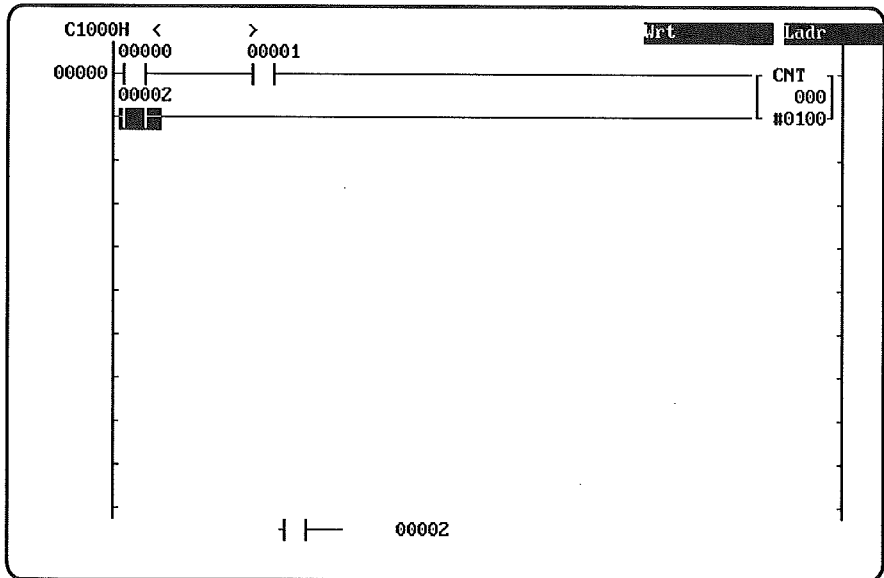

2. Press the PgUp Key. The blank line will be created as shown.

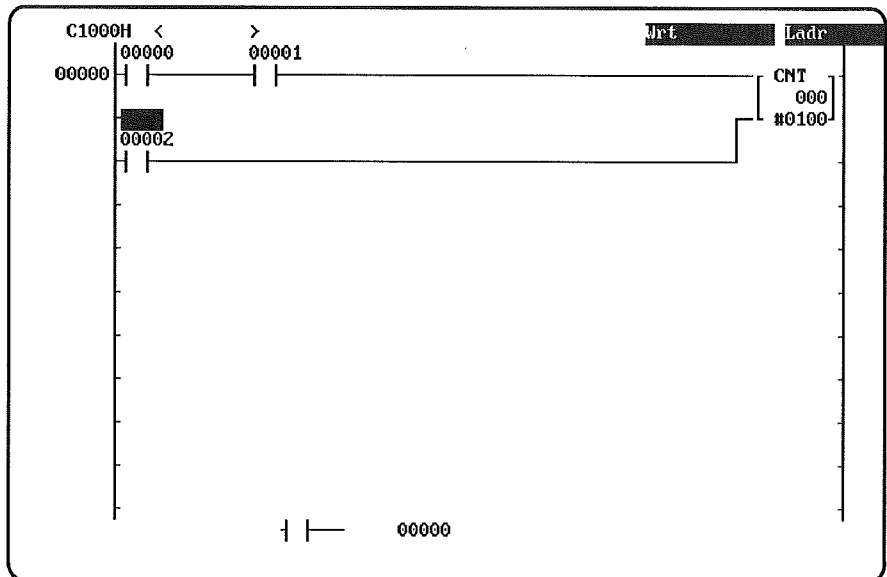

**Creating a Continuous Instruction Line Including an OR**

1, 2, 3...

This example shows a more complex procedure, i.e., creating a continuous instruction line that includes an OR instruction. To simplify the procedure, start by creating the instruction line without the OR.

1. Move the cursor to the final (i.e., the rightmost) column in the line.

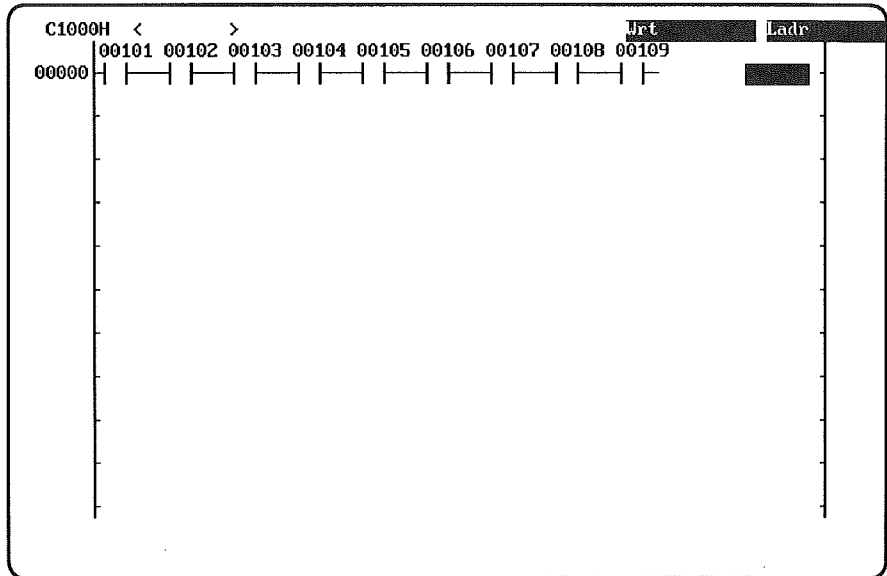

2. Press the F4 Key followed by "1," and then press Enter. This will create the continuous instruction line shown in the following diagram.

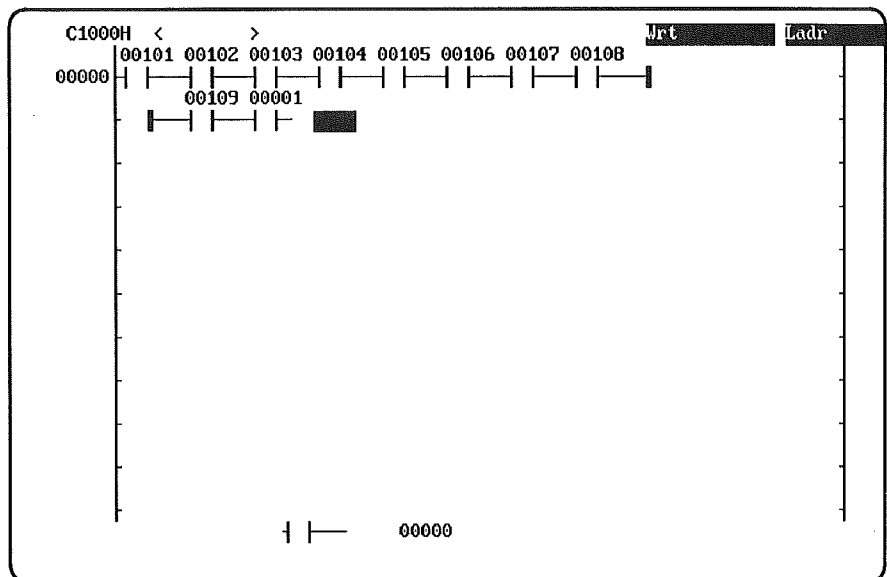

3. Enter the OUTPUT instruction by pressing the F7 Key, followed by "100," and then pressing Enter.

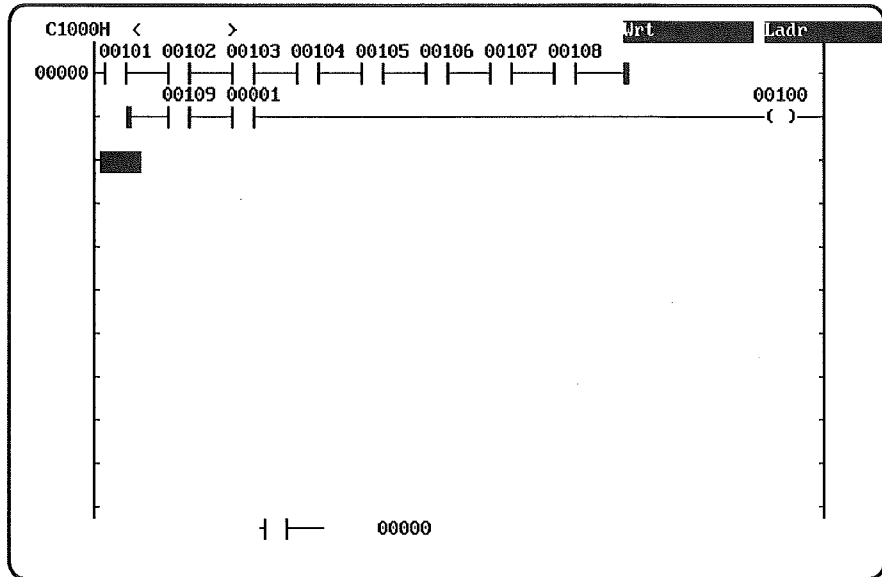

4. Move the cursor up one line (using the Up Cursor Key) and then create a blank line by pressing the PgUp Key.

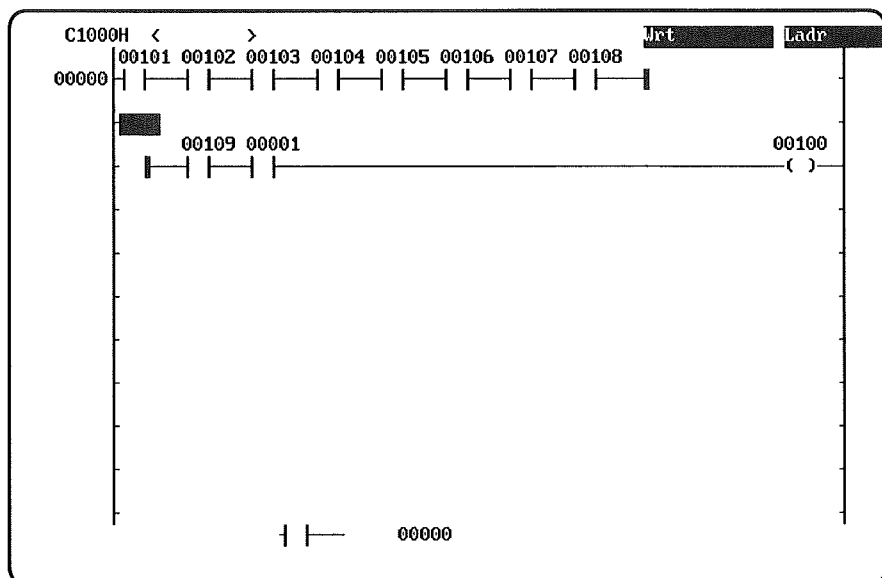

- Finally, create the OR statement by pressing the F5 Key followed by "2" and Enter.

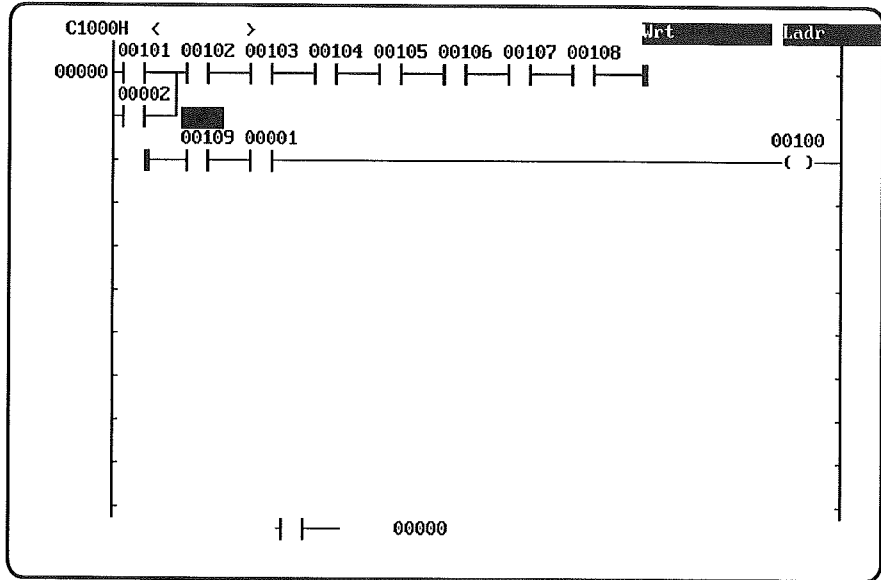

**Reversing NO and NC Conditions**

In this example, a normally open condition is changed to normally closed, but the procedure is the same for changing a normally closed condition to normally open.

1, 2, 3...

1. Move the cursor to the condition that is to be changed.

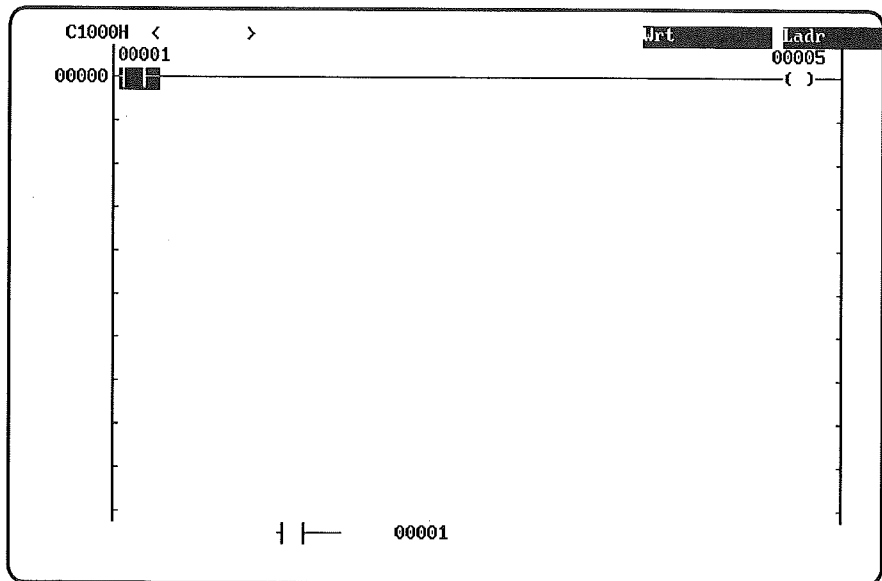

2. Press the / Key or the F9 Key, followed by Enter. The condition will be reversed.

**Editing In Insert Mode**

When there are a number of conditions to be input consecutively, the Insert mode can be used to save having to repeatedly press the Insert Key.

- 1, 2, 3... 1. To go into the Insert mode from the Write mode, press Shift+F2.

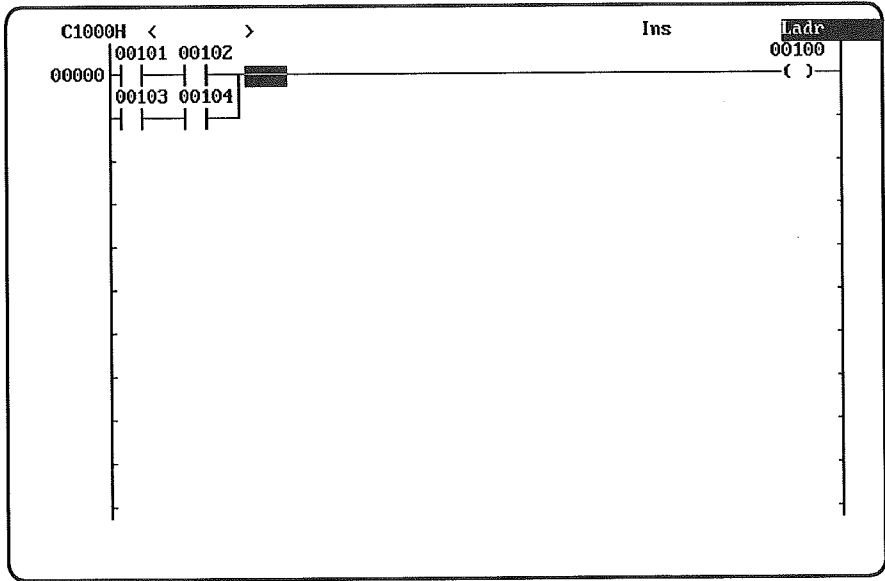

2. Move the cursor to the position where the condition is to be inserted. Then enter the instruction and bit address (by pressing the F4 Key followed by "1" in this example).  
 3. When Enter is pressed, the new condition will be inserted.

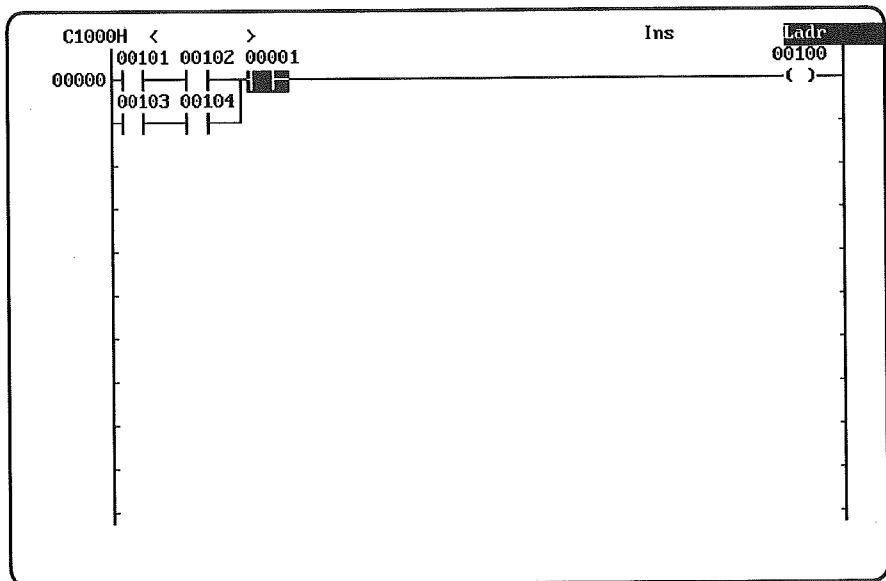

### 2-2-9 Creating I/O, Instruction, and Block Comments

To create I/O comments, instruction comments, or block comments, use the “Ladder w/ comments” display mode.

The methods of writing, editing, storing, and reading ladder diagrams are the same in the “Ladder w/ comments” mode as in the “Ladder diagram” mode. The operation for editing comments is the same as for writing them.

The following table shows the basic functions of these three types of comments.

**Comment Functions**

| Item                 | Function  |
|----------------------|---|
| I/O comments         | Created at the bottom of input and output bits, and serve as comments. Cannot be created for special instructions. Correspond one-to-one to bit addresses.  |
| Instruction comments | Created to the right of right-hand instructions, and serve as comments for instruction blocks and special instructions. When instruction comments are used with OUT, OUT NOT, TIM/CNT, DIFU/DIFD, KEEP, or STEP/SNXT instructions, the output bit comment type must be set to instruction comments in the System Setup. |
| Block comments       | Created between instruction blocks in a ladder diagram.   |

Be sure to store programs after inputting or changing the ladder diagram (including changes to comments).

The number of characters that can be input and displayed for each type of comment is shown in the following table.

| Comment type         | Characters input  | Characters displayed |
|----------------------|-------------------|----------------------|
| I/O comments         | 16                | 4/line x 2 lines     |
| Instruction comments | 32                | 6/line x 2 lines     |
| Block comments       | 60/line x 2 lines | 60/line x 2 lines    |

All of the characters that have been input will be printed out, even if they are not displayed on the screen.

### 2-2-10 Creating I/O Comments

An I/O comment can be written for each input or output bit. I/O comments can be input or changed during ladder diagram input or debugging, thereby making debugging and maintenance operations more efficient.

I/O comments can be written in order of bit address by means of the “N>Edit comments” operation. This operation enters the comments for each input and output in the I/O comment table.

Another way of writing I/O comments is to input them directly while creating the ladder diagram. This way is described here.

To use this method, select the “Ladder w/ comments” display mode from the “H:Change display” operation in the Programming Menu. I/O comments can then be input or displayed. The maximum number of characters that can be written for an I/O comment is 16. The number that can be displayed is 8.

I/O comments created by means of this procedure will also be displayed on the “Edit I/O comments” screen. Likewise, I/O comments created by means of “N>Edit comments” will be displayed when changing to the “Ladder w/ comments” display mode using “H:Change display.”

After being input, an I/O comment is actually written when Enter is pressed. The ladder diagram still must be stored, however, after the program has been created. If the ladder program is not stored, then any changes to it will be lost (even though the I/O comment will be saved).



**Note** For information on using the “D:Retrieve comments” operation to retrieve I/O, instruction, and block comments from programs stored on the data disk, refer to 2-4-3 *Retrieving Comments*.

**Example 1: Writing I/O Comments while Coding**

- 1, 2, 3... 1. Select “H:Change display” from the Programming Menu.

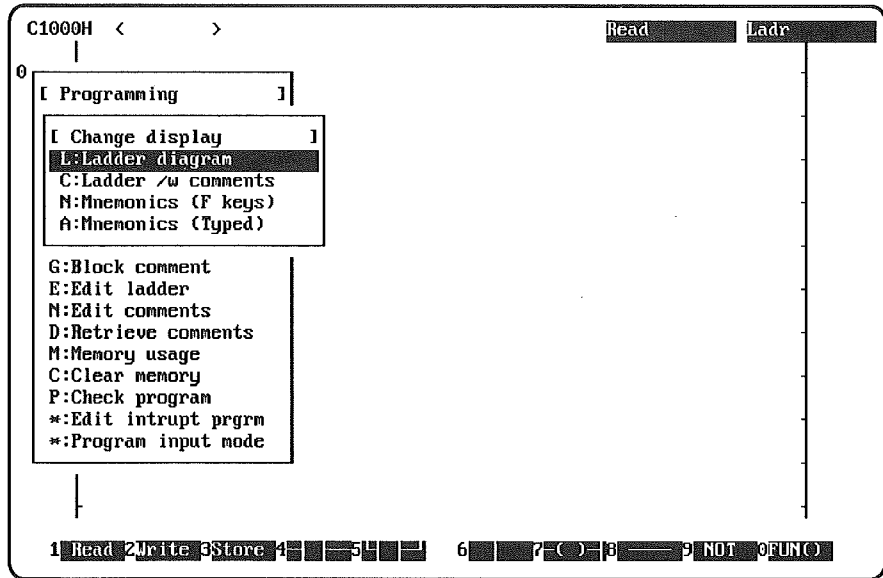

2. Select “C:Ladder w/ comments.”  
 3. If in the Read mode, press the F2 Key to change to the Write mode.  
 4. Write the bit address (“101” in this example), and then press Enter.

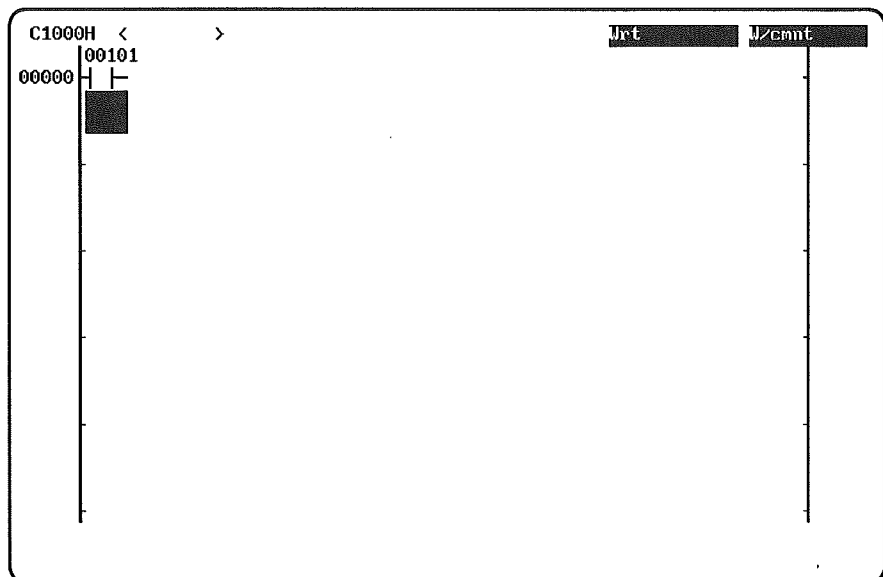

- Write the I/O comment. (In this example, first press the Caps Key, and then input "START.") Then press Enter. The input bit address and the comment will be displayed.

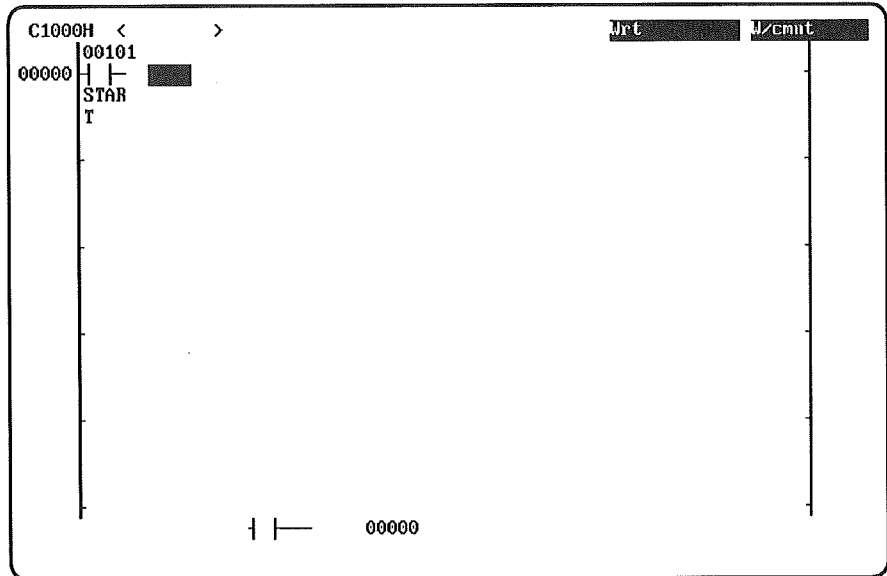

**Example 2: Writing I/O Comments for Existing Programs**

- 1, 2, 3...
  - If in the Read mode, press the F2 Key to change to the Write mode.
  - Move the cursor to the line below the condition where the I/O comment is to be written or edited.

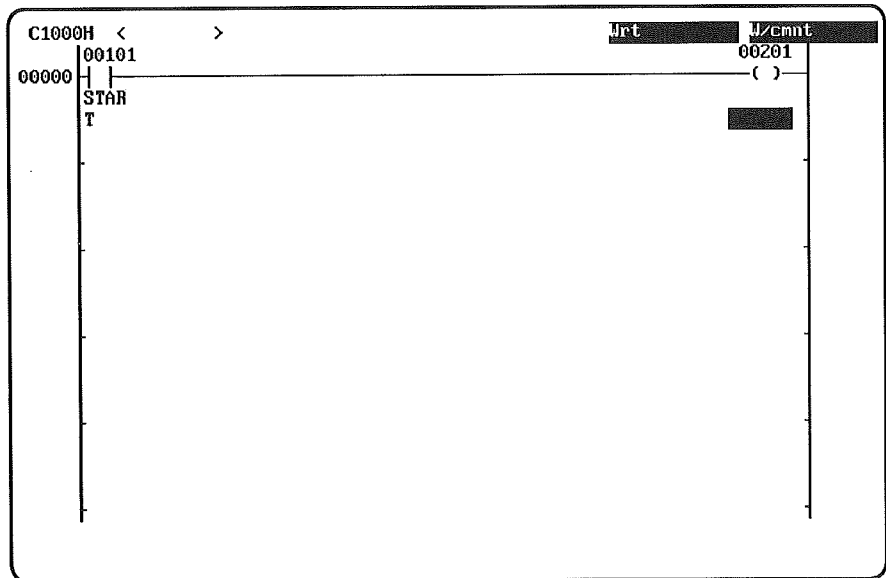

3. Press Enter. An input area will appear.

4. Input the I/O comment (in this example, input "VALVE1") and press Enter.

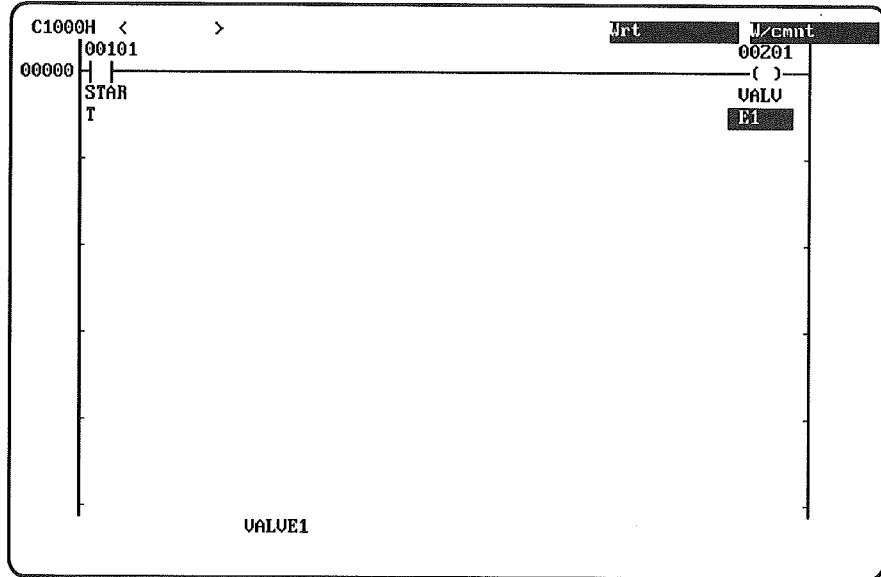

### 2-2-11 Creating Block Comments

Block comments can be written to help explain programming. To create a block comment, use the "Ladder w/ comments" display mode. All letters and numbers are permitted in block comments. Each block comment is denoted with an asterisk (\*) before it.

A maximum of 60 letters and numbers can be used in one line, and two lines can be created at one time. Four lines of comments can be created for one instruction line, but the first and second lines must be created or it will not be possible to create the third and fourth.

To create a block comment, place the cursor at the beginning of a blank line next to the left bus line (the vertical line on the left side of the ladder diagram). After the comment has been created, be sure to store it.

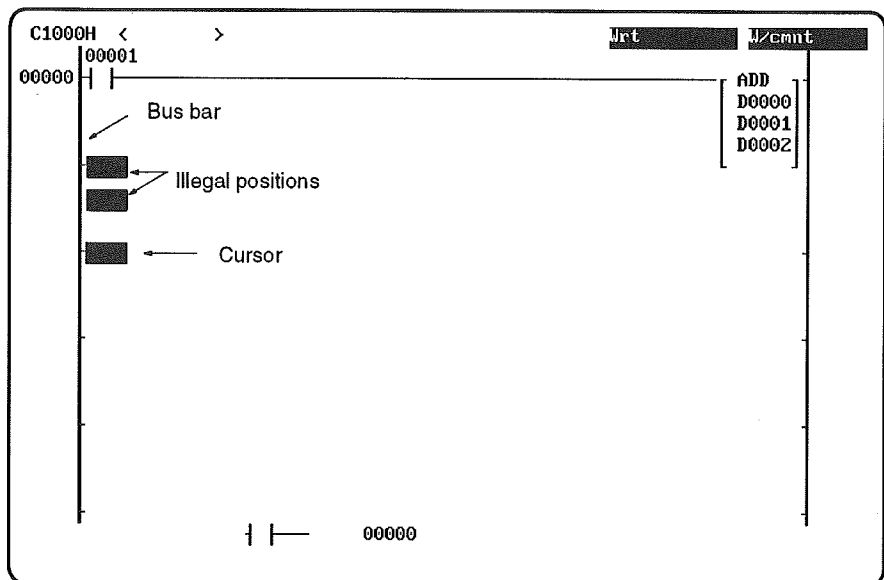

If there is no blank line, then create one by pressing the PgUp Key in Write mode. After the blank line has been created, then the block comment can be created.

There is also a way to create a block comment without first creating a blank line. First read the instruction block before the line where the block comment is to be inserted. Then go into Write mode and create the block comment. After writing the block comment, be sure to store it. When a block comment is inserted between two instruction blocks in this way, it will be inserted automatically with no need to create a blank line first.

**Caution** A block comment can be accidentally deleted in the "Ladder diagram" display mode by using the PgUp or PgDn Key to read instruction blocks before and after the line comment. If the program is then stored, the line comment will be lost.

**Procedure**

- 1, 2, 3...
1. Select "H:Change display" from the Programming Menu, and then select the "C:Ladder w/ comments" display mode.
  2. Press the F2 Key to go into the Write mode.
  3. Move the cursor to a blank line. If there is no blank line, press the PgUp Key to create one.
  4. Press the End Key to display the Programming Menu. Then select "G:Blockcomment." An input area will appear.
  5. Write the block comment ("ALARM SWITCH," in this example).
  6. After the block comment has been written, press Enter twice. The comment will be denoted with an asterisk (\*) before it.

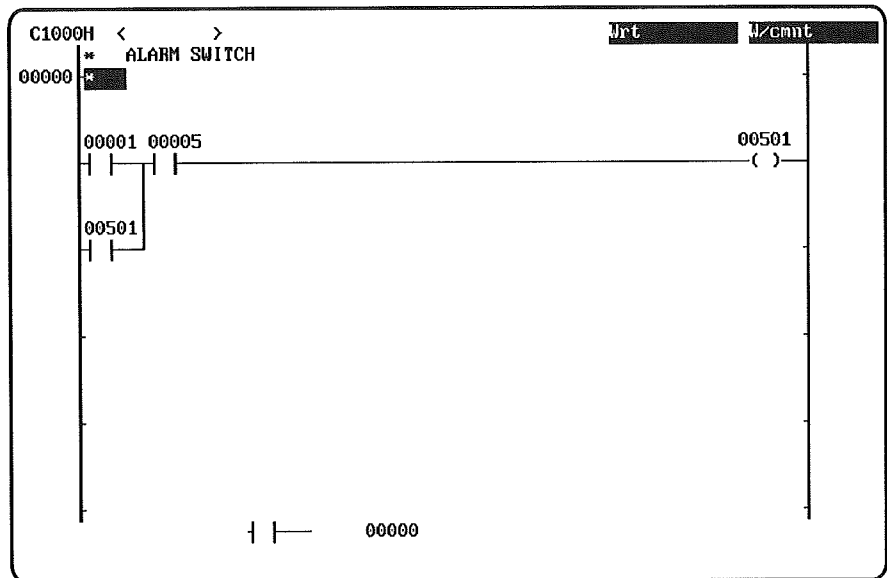

7. After all block comments have been written, store the program by pressing the F3 Key followed by Enter.

### 2-2-12 Creating Instruction Comments

Instruction comments can be written for output instructions (instruction blocks and special instructions) to check operating conditions. Up to 32 characters (any letters or numbers) can be used for an instruction comment, and two lines of six characters each can be displayed on the screen at one time.

When instruction comments are used with OUT, OUT NOT, TIM/CNT, DIFU/DIFD, KEEP, or STEP/SNXT instructions, the output bit comment type must be set to instruction comments in the System Setup. If it is set to I/O comments, then instruction comments cannot be written.

After writing instruction comments, be sure to store them.

Instruction comments are deleted when their corresponding output instructions are deleted.

**Procedure**

This example procedure shows how to write the instruction comment shown in the following diagram.

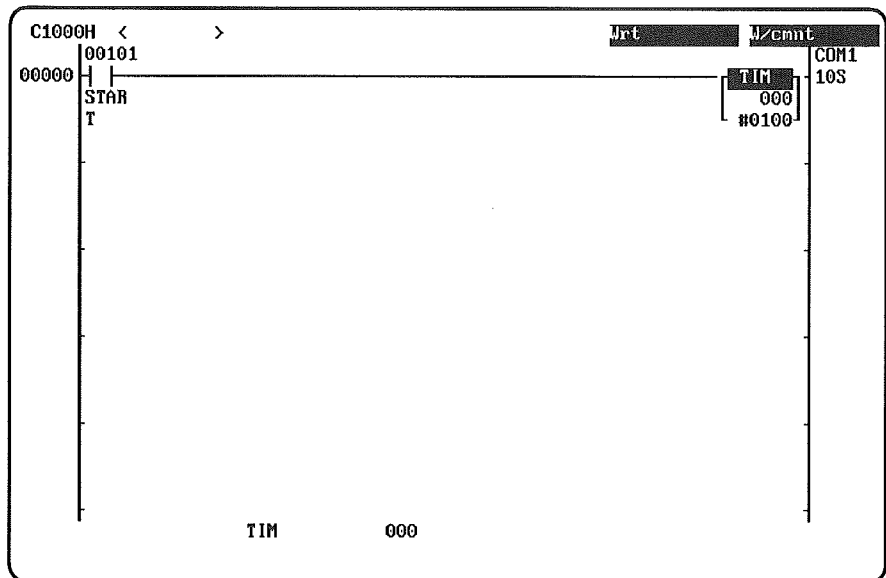

1, 2, 3...

1. Select "H:Change display" from the Programming Menu, and then select the "C:Ladder w/ comments" display mode.
2. Press the F2 Key to go into the Write mode.

3. Move the cursor to the top line of the TIM instruction. The instruction comment can only be written in this position.

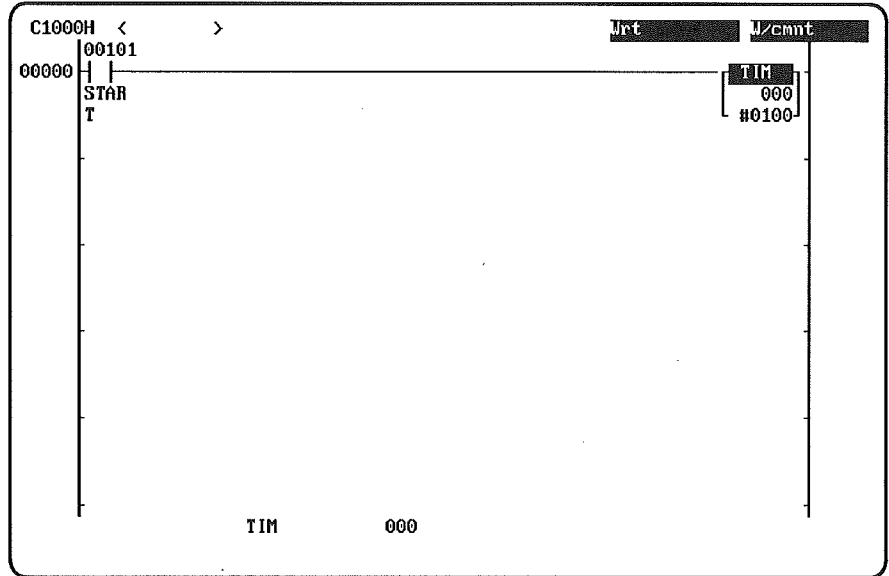

4. Press the End Key to display the Programming Menu. Then select "Y:Instr comment." An input area will appear.
5. Input "Delay:10s," and then press Enter. The instruction comment will then be displayed to the right of the TIM instruction.

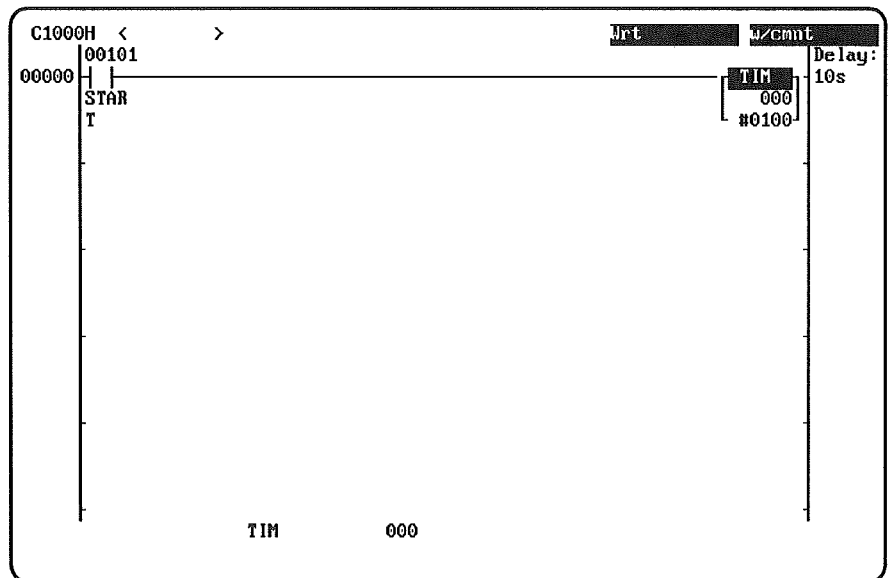

6. Store the program by pressing the F3 Key followed by Enter.

## 2-2-13 Summary of Operations in Write Mode

### Write Mode Operations









Write mode operations are summarized in the following table.

| Instruction                              | Keys used   |
|--|---|
| NO condition                             | <i>Bit_address</i> Enter  |
| NC condition                             | F9 <i>Bit_address</i> Enter   |
|  | Shift+F4 <i>Bit_address</i> Enter   |
| NO OR                                    | F5 <i>Bit_address</i> Enter   |
| NC OR                                    | F5 F9 <i>Bit_address</i> Enter  |
|  | Shift+F5 <i>Bit_address</i> Enter   |
| OUT                                      | F7 <i>Bit_address</i> Enter   |
| OUT NOT                                  | F7 F9 <i>Bit_address</i> Enter<br>or<br>Shift+F7 <i>Bit_address</i> Enter   |
| TIMER                                    | Ctrl+F6 <i>Timer_number</i> Enter<br>Then<br><i>Set_value</i> Enter   |
|  | or<br>Ctrl+F7 <i>Word_address</i> Enter   |
| COUNTER                                  | Ctrl+F5 <i>Counter_number</i> Enter<br>Then<br><i>Set_value</i> Enter   |
|  | or<br>Ctrl+F7 <i>Word_address</i> Enter   |
| SET (See note.)                          | Shift+F8 <i>Bit_address</i> Enter   |
| RESET (See note.)                        | Shift+F9 <i>Bit_address</i> Enter   |
| Instructions with function codes         | F10 <i>Function_number</i> Enter<br>( <i>Operand</i> Enter) ( <i>Operand</i> Enter)<br>( <i>Operand</i> Enter)  |
| Differentiated instructions (with @)     | F10 <i>Function_number</i> (@, I, or F9) Enter<br>( <i>Operand</i> Enter) ( <i>Operand</i> Enter)<br>( <i>Operand</i> Enter)                                |
| Block programming instructions (with <>) | Store program, switch to mnemonic display, then<br>Shift+F10 <i>Function_number</i> ( <i>Operand</i> )<br>( <i>Operand</i> ) ( <i>Operand</i> ) (F9) Enter  |
| Horizontal connections                   | F8 Enter  |
| Vertical connections (See note 2.)       | F6 Enter  |
| Connect line                             | (Move cursor to start point) End Enter<br>(Move cursor to end point) Enter<br>or<br>(Move cursor to start point) Ctrl+L<br>(Move cursor to end point) Enter |

- Note**
1. SET and RESET are enabled only when the Programmable Controller model is set to either CQM1 or C200HS in the System Setup.
  2. Use the "R:Connect line" operation to create a lines to right-hand instructions. The F6 Key can only be used for creating vertical lines up to within two places to right-hand instructions.

**Write Mode  
Function Keys**

The following table provides a list of function keys available in Write mode.

| Key            |  | Function  |
|----------------|--|---|
| F1             | Read   | Used to switch to the Read mode. Once in the Read mode, you can scroll through the program in the system user area using the cursor keys and PgUp/PgDn Keys.              |
| F2             | Write  | Used to switch to the Write mode. The Write mode can be used to input instructions or to edit instruction in the instruction block(s) that are currently being displayed. |
| F3             | Store  | Used to save the instruction block(s) shown on the display to the instruction block last read from the system work area.  |
| F4             |   | Used to designate LD and AND instructions.  |
| F5             |   | Used to designate OR instructions   |
| F6 or Shift+F6 |   | Used to create vertical lines.  |
| F7             |   | Used to designate OUT instructions  |
| F8             |   | Used to create horizontal lines.  |
| F9             | NOT  | Used to change a symbol to a NOT instruction.   |
| F10            | FUN( )   | Used to designate instructions via function codes.  |
| Shift+F1       | Dele   | Used to switch to the Delete mode.  |
| Shift+F2       | Inser  | Used to switch to the Insert mode.  |
| Shift+F3       | Strln  | Used to add the instruction block(s) shown on the display to the front of the instruction block last read from the system work area.                                      |
| Shift+F4       |   | Used to specify LD NOT and AND NOT instructions.  |
| Shift+F5       |   | Use to specify OR NOT instructions  |
| Shift+F7       |  | Used to specify OUT NOT instructions.   |
| Shift+F8       | SET  | Used to specify SET instructions for PCs that support them. (CQM1 and C200HS only.)   |
| Shift+F9       | RSET   | Used to specify RSET instructions for PCs that support them. (CQM1 and C200HS only.)  |
| Shift+F10      | FUN<>  | Used to specify block instructions via function codes.  |
| Ctrl + F1      | AR   | Used to specify bit and word addresses in the AR area.  |
| Ctrl + F2      | HR   | Used to specify bit and word addresses in the HR area.  |
| Ctrl + F3      | LR   | Used to specify bit and word addresses in the LR area.  |
| Ctrl + F4      | DM   | Used to specify word addresses in the DM area.  |
| Ctrl + F5      | CNT  | Used to specify counter numbers (see note 1).   |
| Ctrl + F6      | TIM  | Used to specify timer numbers (see note 1).   |
| Ctrl + F7      | Wd   | Used to specify word addresses.   |
| Ctrl + F8      | *DM  | Used to specify indirect DM addresses   |
| Ctrl + F9      | Bit  | Used to specify bit addresses.  |
| Ctrl + F10     | #  | Used to specify constants (see note 2).   |

- Note**
1. Control +F5 or Control + F6 are used when inputting counter or timer instructions or when specifying PV as word operands. They are also used to specify Completion Flags when input for bit operands.
  2. The F4 Key is pressed to input signed BCD for constants. Press the F4 Key after designating a constant (Control + F10) to input constants in BCD. The F5 Key can be used to toggle between positive and negative values. The value will be displayed on the ladder diagram in hexadecimal. For information on inputting BCD (with and without sign), refer to 2-2-4 *Entering Bit/Word Address and Data*.



## 2-3 Storing and Checking Programs

This section explains how to use the Store, Store Insert, and Check Program operations.

### 2-3-1 Store/Store Insert

The Store and Store Insert operations are used to write a ladder program created on the screen to the system work area. Use Store when newly creating or editing ladder programs. Use Store Insert to insert a an edited ladder instruction block while leaving the original ladder program unchanged.

The Store and Store Insert operations can be used on up to 22 instruction lines (the maximum number permitted in an instruction block) at a time.

When an instruction block is edited and stored using Store, the ladder program in the system work area will be replaced by the edited version. With Store Insert, on the other hand, the instruction block that was read will be retained just as it is, and the edited instruction block will be inserted just before it. Subsequent instruction blocks will be moved down.

**Note** The Store operation is used when continuously writing new programs to memory, i.e., each time the Store operation is used, the next (blank) portion of memory is read. When an instruction block is input and then stored, it overwrites the previously blank portion of memory, allowing you to continuously input consecutive instruction blocks.

**Caution** Ladder programs created on the screen but not saved with the Store or Store Insert operations may be lost when menus are switched, the reset switch is pressed, or the POWER switch is turned off.

### Store vs Store Insert

The Store operation is used to write a new ladder instruction block when editing instruction blocks stored in the system work area. The Store Insert operation is used to insert an unchanged or partially edited instruction block into the system work area in front of its original position.

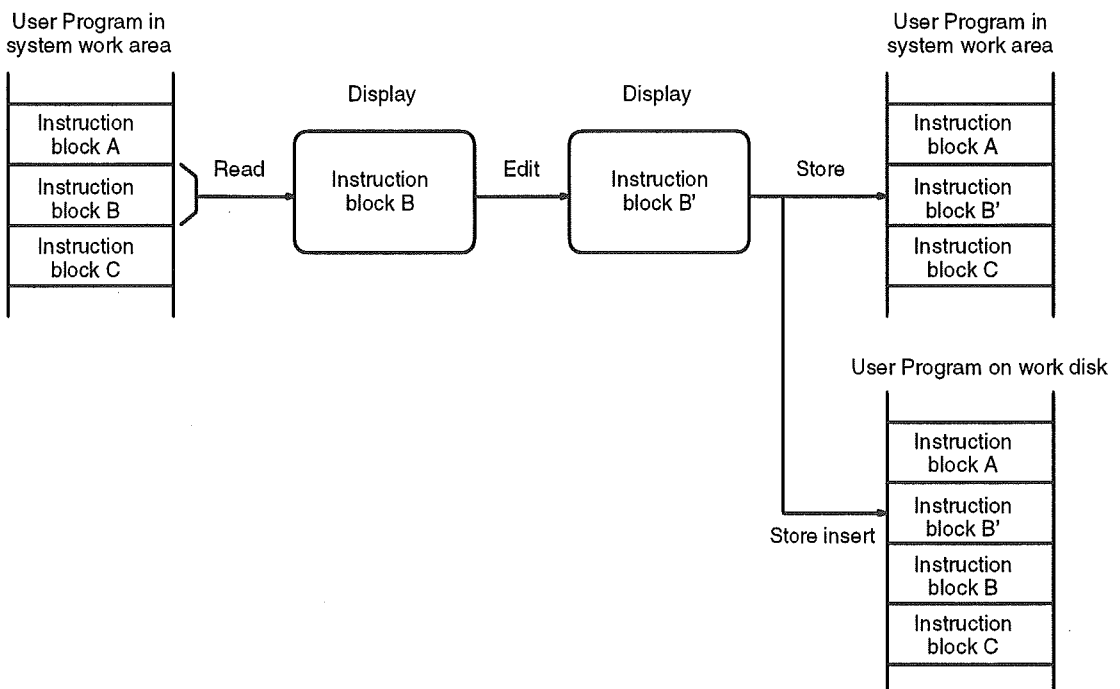

**⚠ Caution** An instruction block read from the system work area and then deleted on the screen will be permanently lost if the Store operation is used to write it back to the system work area after deletion. Take particular care in cases like the example below, where several Instruction blocks are read and deleted on screen and another Instruction block is created. When the new instruction block is stored to the system work area, the instruction blocks read originally will all be permanently lost. They would not be lost if the Store Insert operation was used.

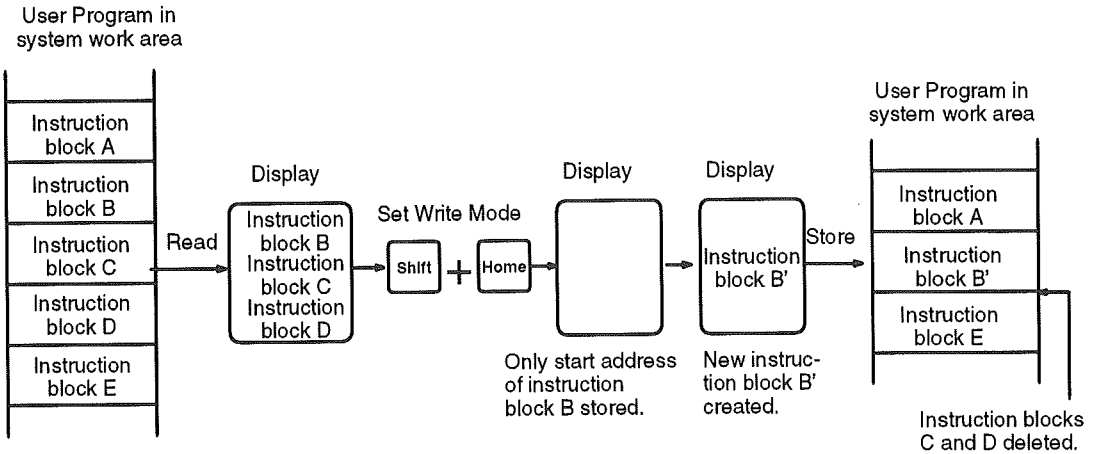

**Store/Store Insert Functions**

| Item         | Key sequence    | Comments  |
|--------------|-----------------|---|
| Store        | <b>F3 Enter</b> | Writes the ladder instruction block(s) created on the screen (with a maximum of 22 instruction lines) to the work disk.<br><br>A message will flash to indicate that the program is being stored. After the program is stored, the screen will return to the Write mode and the next address will be displayed.<br><br>The addresses of each instruction is fixed when the program is stored. The addresses will be displayed again the next time the program is read.<br><br>After an instruction block is read, edited and stored, only the edited version of the instruction block is stored on the work disk. |
| Store insert | <b>F4 Enter</b> | Writes the ladder instruction block(s) created on the screen (with a maximum of 22 instruction lines) to the work disk in front of the previously read instruction block. The previous instruction block remains unchanged on the work disk, behind the new, inserted instruction block.<br><br>A message will flash to indicate that the program is being stored. After the program is stored, the screen will return to the Write mode and the next address will be displayed.  |

**Note** The Store operation is used when continuously writing new programs to memory, i.e., each time the Store operation is used, the next (blank) portion of memory is read. When an instruction block is input and then stored, it overwrites the previously blank portion of memory, allowing you to continuously input consecutive instruction blocks.

**Illegal Instruction Blocks**

An error message will be displayed and the Store or Store Insert operation cancelled if an attempt is made to use the store/store insert operations with an incorrect instruction block or one which cannot be processed by the SSS. Correct and edit the instruction block if this problem occurs.

**Incomplete Instruction Lines**

a) No right-hand instruction



b) Broken connection



c) Instruction lines not entered for an execution condition



d) Surplus line



e) No conditions on an instruction line



f) Short-circuited conditions

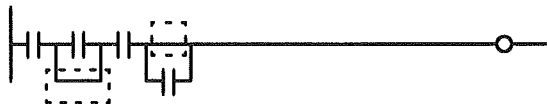

g) Instruction line doubles back



**Incorrect Instruction Blocks**

The following instruction blocks (on the left) cannot be processed. Correct them as shown on the right. (Although the wrong version of programming in item "a)" will be stored, the program will not be executable unless the ladder diagram is rewritten like that shown on the right.)

a) Two instruction blocks included on a single line

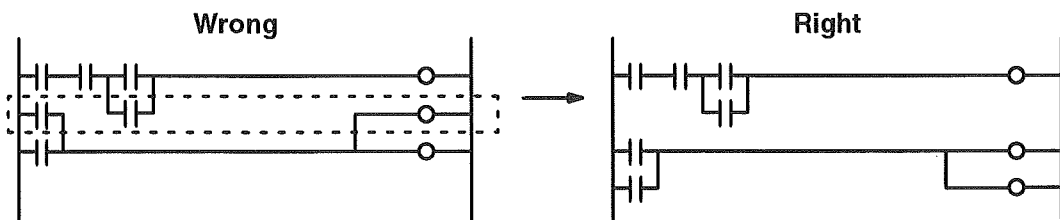

b) AND and OR instructions inside OR instructions. Move AND and OR to the bottom of the OR.

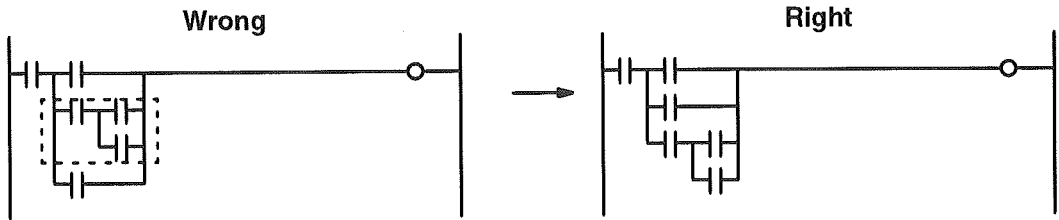

c) Horizontal line in front of OR instruction with no condition on the line. Conditions must be aligned on the left.

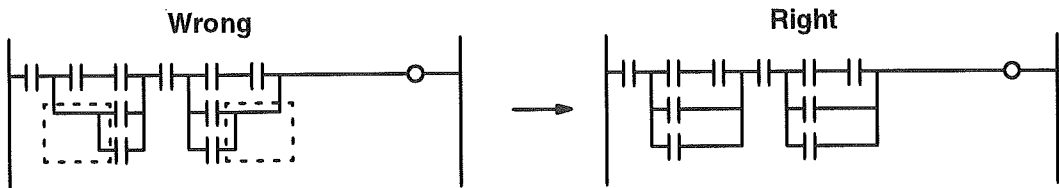

d) More than 8 LD instructions used (use mnemonic display if more than 8 LD instructions are required).

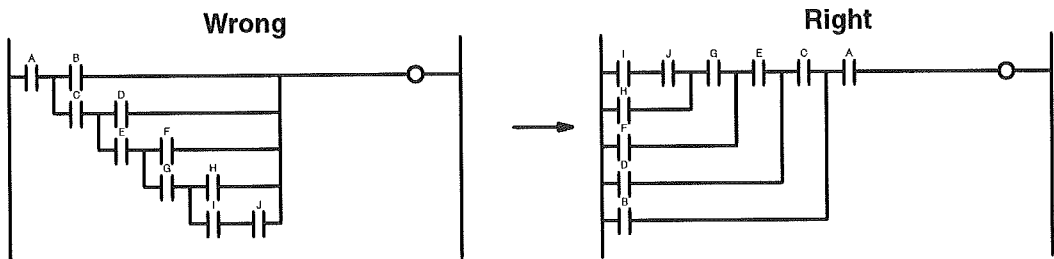

e) Multiple continue operations. Do not use continue operations in parallel.

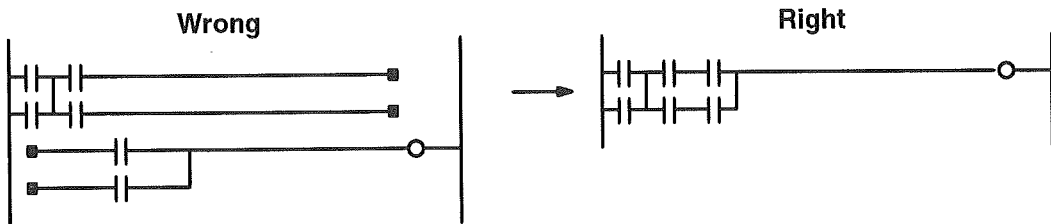

f) Continue instruction sandwiched between right-hand instructions. Move the continuous line to the top.

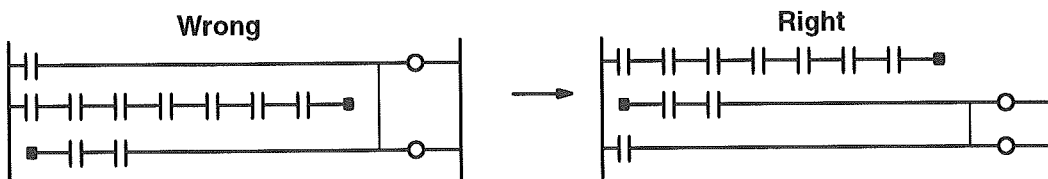

**Store/Store Insert Procedure**

- 1, 2, 3...
1. In the Write mode, press the F3 Key for the Store operation or the Shift Key + the F3 Key for the Store Insert operation.
  2. Begin the Store or Store Insert operation by pressing Enter. Either Store or Store Insert will flash at the upper right of the screen.
  3. When the operation is complete, the Write mode will resume and the next program address will be displayed.

**2-3-2 Checking the Program**

The "Check program" operation is used to check whether the program in the system work area is correct. It can be used regardless of whether the program was written in ladder or mnemonic form.

Always use this operation to check a newly created or edited ladder program after storing the program in the system work area.

Any of the following check levels can be selected for checking the program.

| Check level | Contents  |
|-------------|---|
| A           | Errors in program that prevent intended instructions from being executed.   |
| B           | Syntax errors that do not prevent intended instructions from being executed. (Alarms)   |
| C           | Errors such as omissions from the program or output timing errors that could prevent instructions from being executed properly. |

Program instructions and operand values are checked according to the PC model specified in the System Setup.

The program is checked until the first END instruction is reached. To check the entire program, do not include any END instructions until the very end of the program.

If there are any errors, the messages will be displayed when the program check is complete. Check the contents of the error messages and correct them. Then execute the program check again.

The time required to check the program will depend on the size of the program.

The program check will be carried out according to the maximum program capacity for that particular Programmable Controller model. If that capacity is exceeded, a "Need an END" error message will be displayed. The maximum capacity for each model is shown in the following table.

| Model           | Storage Capacity     |
|-----------------|----------------------|
| C20             | 1,194 words          |
| C120            | 24,576 bytes         |
| C500            | 24,576 bytes         |
| C1000H, C2000H  | 32,768 words         |
| P-type PCs      | 1,194 addresses      |
| K-type PCs      | 1,194 addresses      |
| C200H           | 6,974 words          |
| C200HS          | 15,200 words         |
| Mini H-type PCs | 2,878 words          |
| CQM1            | 3,200 or 7,200 words |

Procedure

- 1, 2, 3... 1. Select "P:Check program" from the Programming Menu.

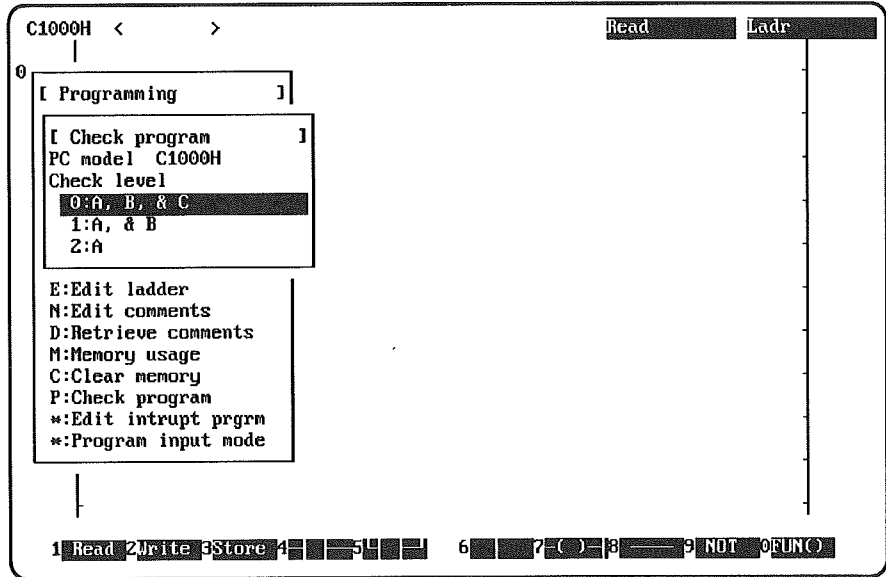

2. Specify the level(s) to be checked, and press Enter. The program check will then begin and a message will flash on the display.
3. When the check is complete, the results will be displayed.

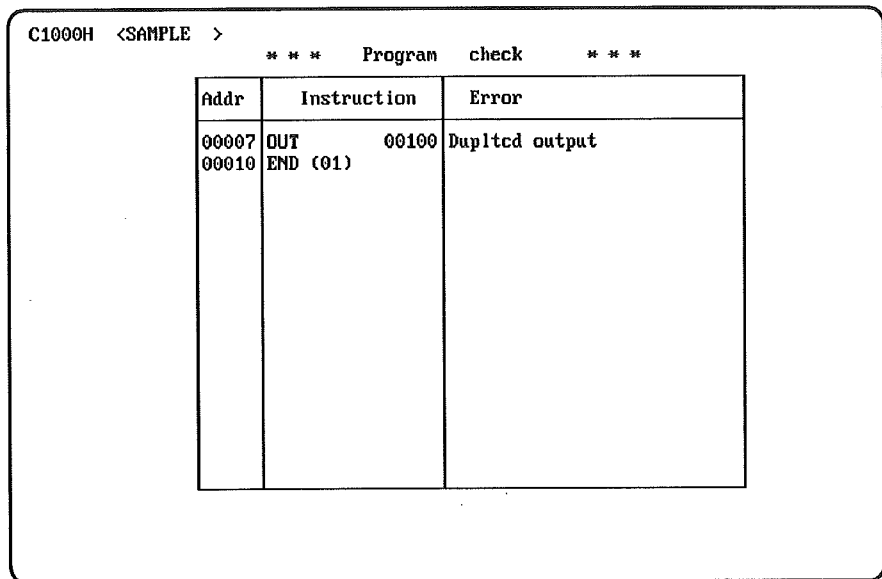

If there are no errors, only the END instruction will be displayed. If the errors cannot be displayed on a single page, use the PgDn and PgUp Keys to scroll the pages. If there are errors, correct them and run the program check again. If there are more than 1,024 errors (64 screens), the errors exceeding that amount will not be displayed.

4. To return to the Programming Menu, press the Escape Key.

**Error Messages**

| Rank       | Message                      | Description   | Remedy   |
|------------|------------------------------|---|--|
| A          | ?????                        | Program contents destroyed. Invalid instruction code.   | Enter correct instructions at the ???? parts of the program. |
|            | Lad error                    | Syntax error in instruction block. Number of LD instructions disagrees with number of logic block instructions (OR LD, AND LD). | Check the program.   |
|            | Wrong data                   | Incorrect operand set for an instruction.   | Enter correct operand.                                       |
|            | Need an END                  | No END instruction in the program   | Enter an END instruction at the end of the program.          |
|            | Data error                   | Instruction used in incorrect memory area   | Check use of instruction and correct program                 |
|            | Duplctd No.                  | SBN, BPRG, or JME number used twice.  | Check and correct program                                    |
|            | Wrong use of BPRG-BEND       | BPRG, BEND not used in pairs  |  |
|            | Wrong use of IF-IEND         | IF-IEND used incorrectly.   |  |
|            | Wrong use of LOOP-LEND       | LOOP-LEND used incorrectly.   |  |
|            | Undefined JME                | No JME corresponding to JMP.  |  |
|            | Undefined SBN                | No SBN corresponding to SBS.  |  |
| STEP error | STEP, SNXT used incorrectly. |   |  |
| B          | IL-ILC error                 | IL, ILC not used in pairs.  | Check and correct program                                    |
|            | Wrong use of SBN-RET         | RET instruction or SBN-RET used incorrectly.  |  |
|            | Too many DIFS                | Too many DIFU or DIFD instructions used (i.e., more than 128 for C500/C120 or more than 48 for P-type PCs).                     |  |
|            | Wrong use of JMP-JME         | JMP, JME not used in pairs.   |  |
| C          | Duplctd output               | Same output bit specified for more than one instruction controlling its status.   | Correct the bit addresses. This problem can cause racing.    |
|            | Need a JMP                   | No JMP address corresponding to JME address.  | Check and correct program                                    |
|            | Need a SBS                   | No SNS address corresponding to SBN address.  |  |

**2-4 Saving and Retrieving Programs****2-4-1 Saving Programs**

Once a program has been completed in the system work area, it can be saved to a data disk using the "S:Save program" operation. This operation cannot be selected if there is no program in the system work area.

Programs can be saved either in DOS or LSS data format. When "S:Save program" is selected from the Programming Menu, the two choices shown in the following table become available. By selecting one of them, either all or part of the program can be saved to the data disk.

| Menu item    | Function  |
|--------------|---|
| Save program | Saves the entire ladder or mnemonic program in the system work area to the data disk. (See note 1.) |
| Save block   | Saves the specified range of the ladder program to the data disk. (See notes 2 and 3.)              |

- Note**
1. To save a mnemonic program, it is first necessary to go into Read mode.
  2. Only "Save program" is available in the mnemonic display mode; it is not possible to use the "Save block" operation.
  3. Once a file has been saved by the "Save block" operation, it can be read only by means of the "Retrieve block" operation.

The path name for the save destination that is set under "Data disk drive" in the System Setup will be displayed. It can be changed on the file name input screen.

When the program is saved, all I/O comments, instruction comments, and block comments will be saved with it. If "Save block" is selected, however, only those I/O comments within the specified range of bit addresses will be saved. Word I/O comments will not be saved.

If the Programmable Controller model is either a CQM1 or C200HS, the instructions table will be saved under the same file name as the program. For information regarding instructions tables, refer to *5-11 Instruction Tables*.



**Caution** Check file names carefully when saving. When working with LSS files, no distinction is made between files containing entire programs and those containing program blocks. Thus, if an existing file name is specified when executing "Save program" or "Save block," the entire contents of the original file will be replaced by the program or program block that is saved by means of the "Save program" or "Save block" operation.

When working with DOS files, different extensions are used for files containing programs and those containing program blocks. You can still, however, overwrite program files with "Save program" and program block files with "Save block," thus losing the original contents.

### Floppy Disks

Diskettes must be formatted before they can be used. For an explanation, refer to *5-7 Creating LSS Data Libraries*.

Make sure that the diskette is not write-protected.

There are three types of LSS data disk: C2000H, C500, and C2000H/C500. When saving a program, be sure that the Programmable Controller model for which the data disk was initialized matches the "PC model" setting in the System Setup.

Programs cannot be saved if they exceed the free space available on the data disk. Make sure a new data disk is ready in case you need it.



Procedure

1, 2, 3...

1. Select "S:Save program" from the Programming Menu. The following menu will appear.

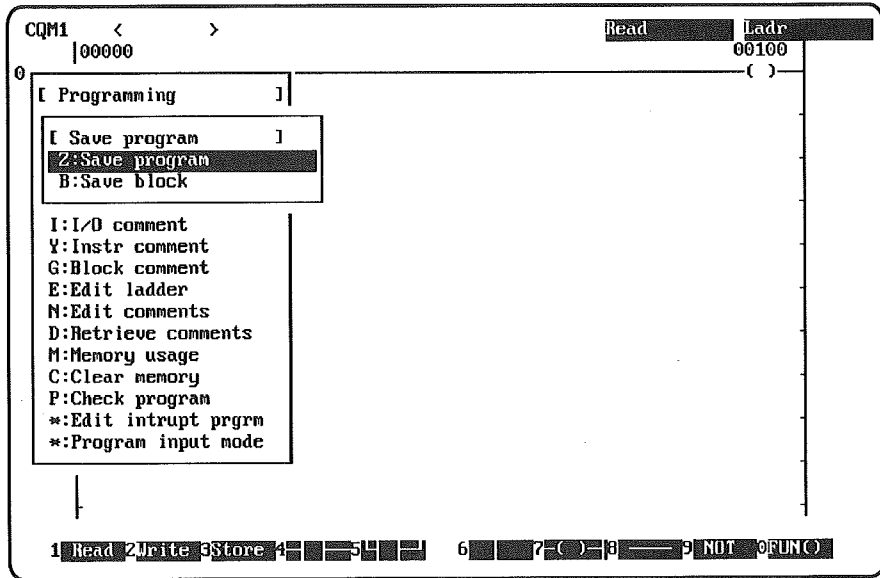

2. Select either "Z:Save program" or "B:Save block." (If the program is in mnemonic form, "Z:Save program" will be selected automatically.) If "Z:Save program" is selected, a screen will appear for entering the file name. If "B:Save block" is selected, a screen will appear for specifying the range of the program that is to be saved. Specify the starting and ending program addresses.

To specify the range, use the PgUp and PgDn Keys to display the required program block, and the Up and Down Cursor Keys to move the cursor to the desired starting and ending program addresses. Press Enter for each.

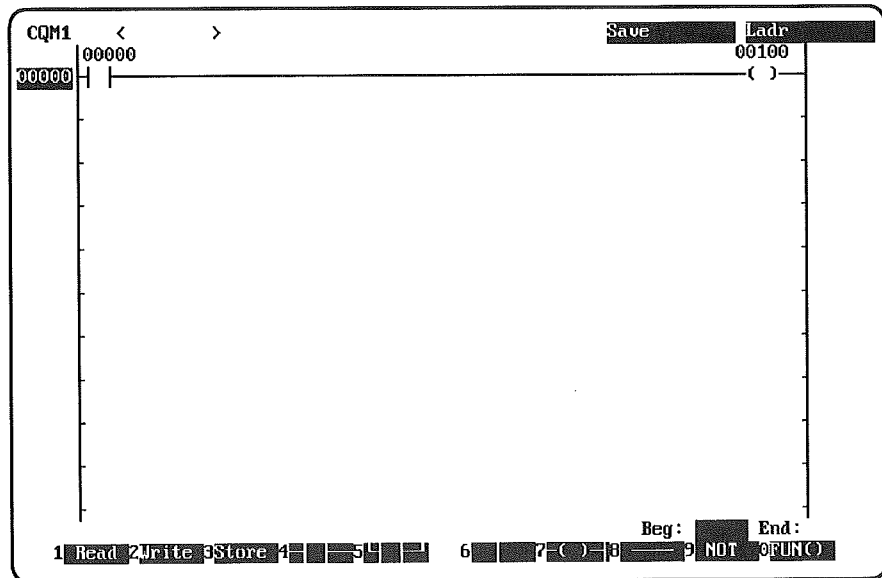

After the ending program address has been specified and Enter has been pressed, the screen for entering the file name will appear.

3. Input the file name, and press Enter. Another way to enter the file name is to press the End Key to display a list of file names on the disk. The file name can then be selected and input from the list.
4. If the file name that is entered already exists, a message will ask if the existing file should be overwritten. To overwrite it, press "Y" followed by Enter. To cancel the operation, press "N" and Enter or just press Enter.
5. When the file name has been entered, and Enter has been pressed, the save operation will begin and either "Save program" or "Save block" will flash. The time required to save the program will depend on the program size. When the operation is complete, the Programming display will return.

If the data disk has been formatted for a Programmable Controller model other than that for which the program in the system work area is set, a message stating that the data disk is wrong will be displayed on the screen.

## 2-4-2 Retrieving Programs

A program stored on a data disk can be retrieved to the system work area by using the "L:Retrieve program" operation. When a program is retrieved, all I/O comments, instruction comments, and block comments will be retrieved at the save time. Programs saved in either DOS or LSS format can be read.

The "L:Retrieve program" menu has two options: "Z:Retrieve program" and "B:Retrieve block." Use "Z:Retrieve program" to read an entire program (i.e., a program saved with "Save program") to the system work area. Use "B:Retrieve block" to insert part of a program (i.e., a program saved with "Save block") into a program that is being created.

| Menu item        | Function  |
|------------------|---|
| Retrieve program | Retrieve the program with the specified file name in the data disk to the system work area. The program in the system work area is lost when a new program is retrieved. (See note.)  |
| Retrieve block   | Retrieve the program block with the specified file name in the data disk to the system work area, from the specified address of the program already in the system work area.<br><br>"Retrieve block" can retrieve only files saved with the "Save block" operation. It cannot be used for mnemonic display. |

**Note** To retrieve a mnemonic program, it is first necessary to go into Read mode.

There are three types of LSS data disk: C2000H, C500, and C2000H/C500. When retrieving a program, be sure that the Programmable Controller model for which the data disk was initialized matches the "PC model" setting in the System Setup.

If the Programmable Controller model is either a CQM1 or C200HS, the instructions table will be retrieved under the same file name as the program. If there is no instructions table with the same file name as the program, no instructions table can be loaded and the instructions table in the systems work area will not be changed. For information regarding instructions tables, refer to *5-11 Instruction Tables*.

**Retrieve Block** Be careful regarding the following points when retrieving blocks.

- If the I/O comments in the program in the system work area is different from a program block that is retrieved, the I/O comments from the program in the system work area will be used.
- If the program in the system work area is different from a program block that is retrieved, and if there are no I/O comments for the program in the system work area, then the I/O comments from the partial program that was retrieved will be used.
- If the Programmable Controller model is changed after a program block has been retrieved to the system work area, the partial program that was retrieved will be deleted.

Procedure

- 1, 2, 3... 1. First select "L:Retrieve program" from the Programming Menu. The following menu will appear.

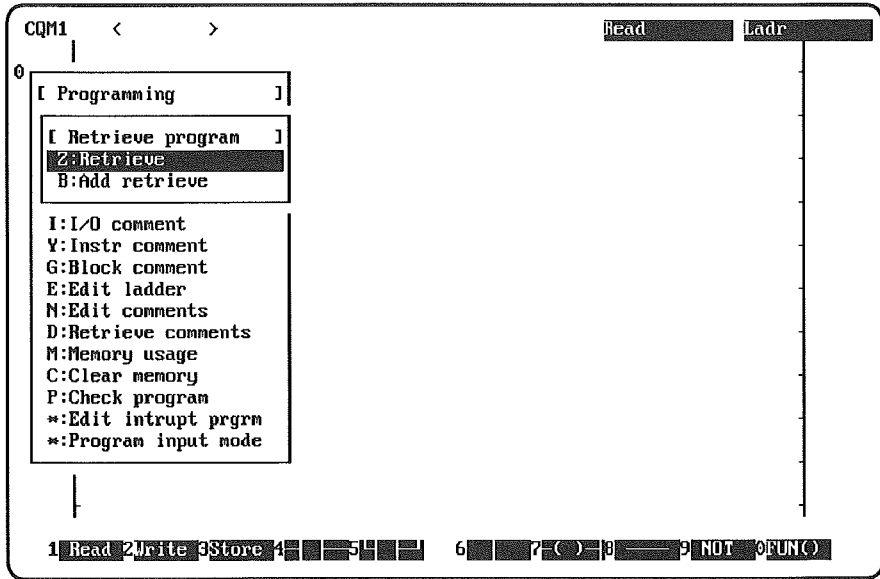

If the program is in mnemonic form, the following screen for inputting the file name for "Z:Retrieve program" will appear directly.

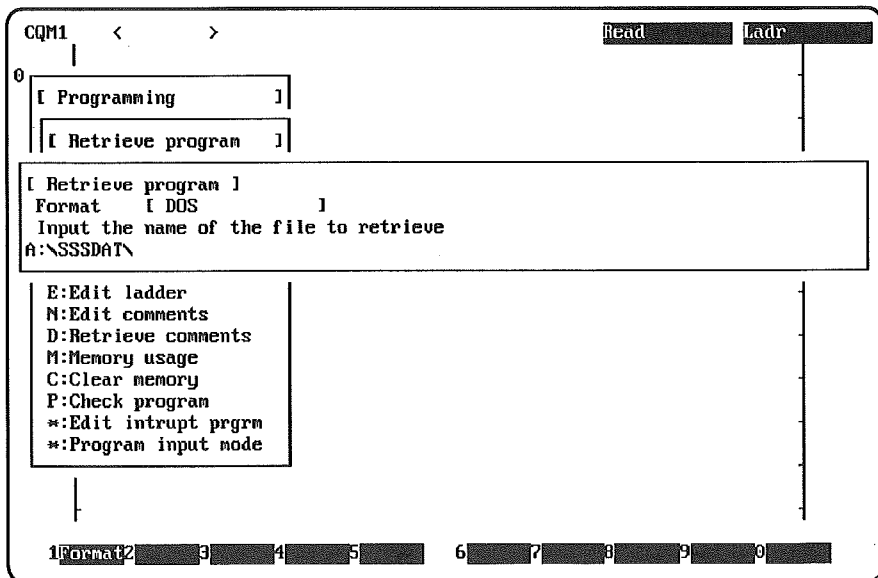

- If the program is in ladder diagram form, select either "Z:Retrieve program" or "B:Retrieve block." If "Z:Retrieve program" is selected, the screen shown above for inputting the file name will appear. If "B:Retrieve block" is selected, the following screen will be displayed, with the beginning destination address displayed at the bottom of the screen. Specify the beginning destination address by using the PgUp and PgDn Keys to display the desired program block, and the Up and Down Cursor Keys to move the cursor to the desired starting program addresses. Then press Enter.

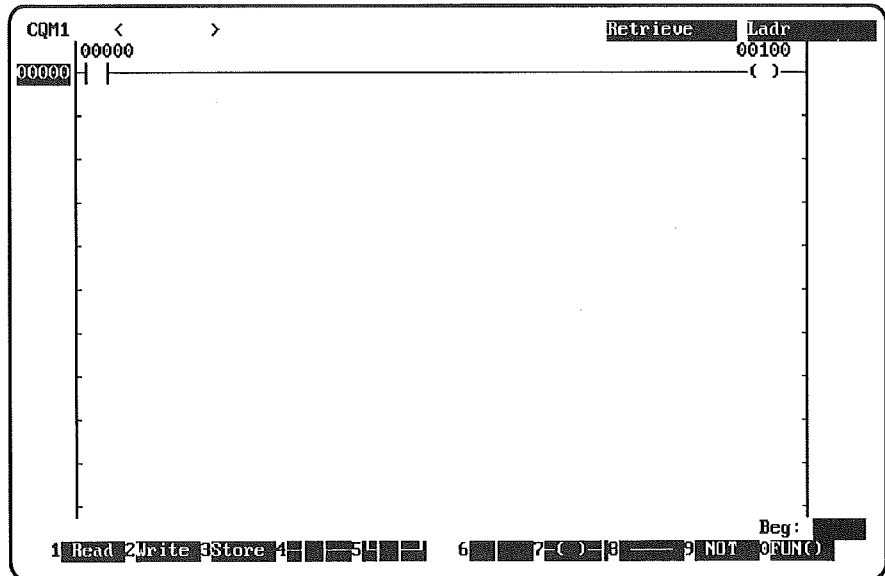

To insert the partial program after the final program address (i.e., at the end of the existing program), move the cursor to the final program address and then press the PgDn Key so that a message on the screen indicates that the final page is displayed. Then press Enter.

It is also possible to search and read according to program addresses and instructions.

- After the destination address has been specified and Enter has been pressed, a screen will appear for entering the file name. Input the file name and then press Enter. Another way to enter the file name is to press the End Key to display a list of program files. The file name can then be selected and input from the list.
- After the file name has been input, pressing Enter will start the retrieve operation. Either "Retrieve program" or "Retrieve block" will flash on the screen.

### 2-4-3 Retrieving Comments

It is possible to retrieve only the comments from a program that has been saved to a data disk.

When "D:Retrieve comments" is executed from the Programming Menu, I/O comments are read to the system work area. The newly retrieved I/O comments are then displayed in the program. The original I/O comments in the program are deleted, and they are replaced by the newly retrieved I/O comments.

At the same time, instruction comments and block comments are read to the system work area displayed on the screen. These comments will be lost if they are not stored after being retrieved.

In order to retrieve comments in mnemonic form, it is first necessary to go into "Read" mode.

The data disk is used as a work area, so it must write-enabled.

## Procedure 1: Retrieving Comments

- 1, 2, 3... 1. Select "D:Retrieve comments" from the Programming Menu.

The screenshot shows a terminal window titled 'CQM1' with navigation arrows. At the top right are 'Read' and 'Ladr' buttons. The main display area shows a menu with the following options:

- I Programming
- [ Retrieve comnt ]
- Format [ DOS ]
- Input the name of the file to retrieve
- A:\SSSDAT\
- Y:Instr comment
- G:Block comment
- E>Edit ladder
- N>Edit comments
- D:Retrieve comments
- M:Memory usage
- C:Clear memory
- P:Check program
- \*:Edit intrupt prgrm
- \*:Program input mode

At the bottom, a numeric keypad is visible with digits 1 through 0.

2. Input the file name and press Enter. Another way to enter the file name is to press the End Key to display a list of programs. The file name can then be selected and input from the list.
- The comments will then be retrieved. While they are being read, the "Retrieve comments" display will flash on the screen. When the operation is complete, the Programming Menu will return.
3. If there are no I/O comments saved in the program file on the data disk, a message will be displayed to inform the user of that fact, and to ask permission to proceed. To abort the operation, input "N" and press Enter. To proceed, just press Enter. If this case, even if the comments are retrieved is pressed, the I/O comments on the screen will not be deleted.

**Procedure 2:  
Copying  
Instruction  
Comments**

When "D:Retrieve comments" is executed, individual instruction comments are copied to the program on the screen from among the comments that are read to the system work area. In this example, an instruction comment will be copied to the output shown in the following program.

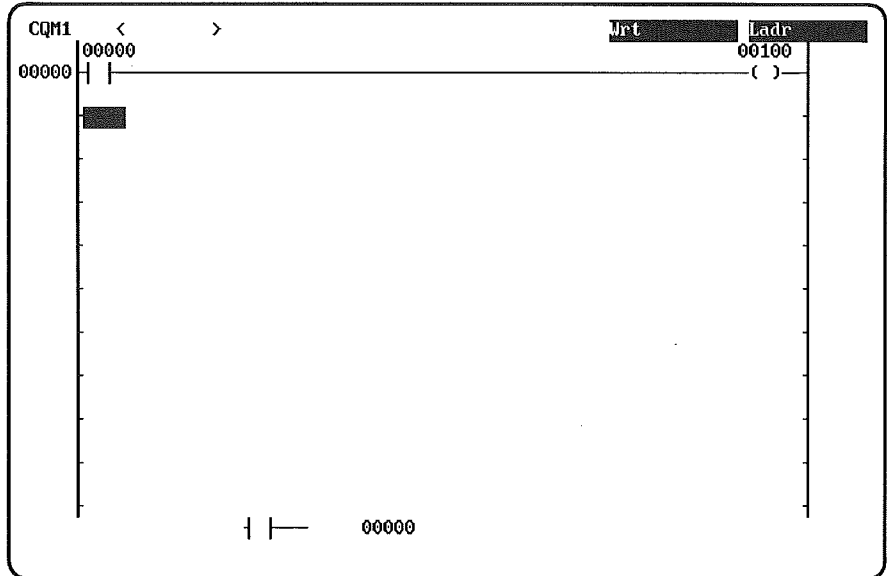

Before the operation can be carried out, there are two settings that must be made in advance. First of all, output bit comment type must be set to instruction comments in the System Setup. In addition, the "H:Change display" operation in the Programming Menu must be set to "C:Ladder w/comments." Once those settings have been made, the operation can be executed using the following procedure.

1, 2, 3...

1. Use the PgUp and PgDn Keys to find the instruction block. Then move the cursor to the output to which the instruction comment is to be copied.
2. Press the F2 Key to go into Write mode.
3. Select "Y:Instr comments" from the Programming Menu. The instruction comment at the beginning of the comments that were retrieved will be displayed.

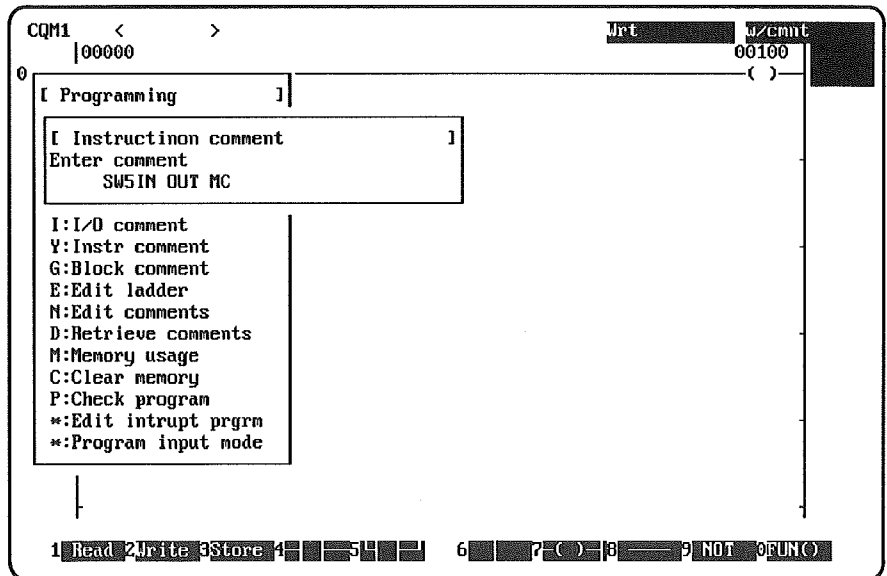

If a message is displayed indicating that the editing mode is wrong, it means that the output comments are not set to "Instruction comments" in the System Setup.

4. If the instruction comment that is currently displayed is the one that is to be copied, then press Enter. If a different one is to be copied, then use the function keys as explained in the following table.

|    |          |  |
|----|----------|--|
| F3 | Previous | Reads the instruction comment just before the one that is currently displayed. |
| F4 | Next     | Reads the instruction comment just after the one that is currently displayed.  |
| F5 | First    | Reads the first instruction comment.   |

5. After finding and displaying the desired instruction comment by using the function keys, press Enter. The comment will be copied to the right of the output bit at the cursor position. It is also possible to edit the comment before pressing Enter.
6. Press the F3 Key followed by Enter to store the comment. To copy instruction comments to other outputs, repeat steps 1 to 5 above.

**Procedure 3:  
Copying Block  
Comments**

When "D:Retrieve comments" is executed, individual block comments are copied to the program on the screen from among the comments that are read to the system work area. In this example, a block comment will be copied to the program shown in procedure 2.

Before the operation can be carried out, the "H:Change display" operation in the Programming Menu must be set to "C:Ladder w/comments." If continuing on from Procedure 2, this setting will have already been made. The operation can then be executed by means of the following procedure.

1, 2, 3...

1. Move the cursor to the left side of the blank line to which the block comment is to be copied. There should be a short horizontal line protruding from the left bus line.

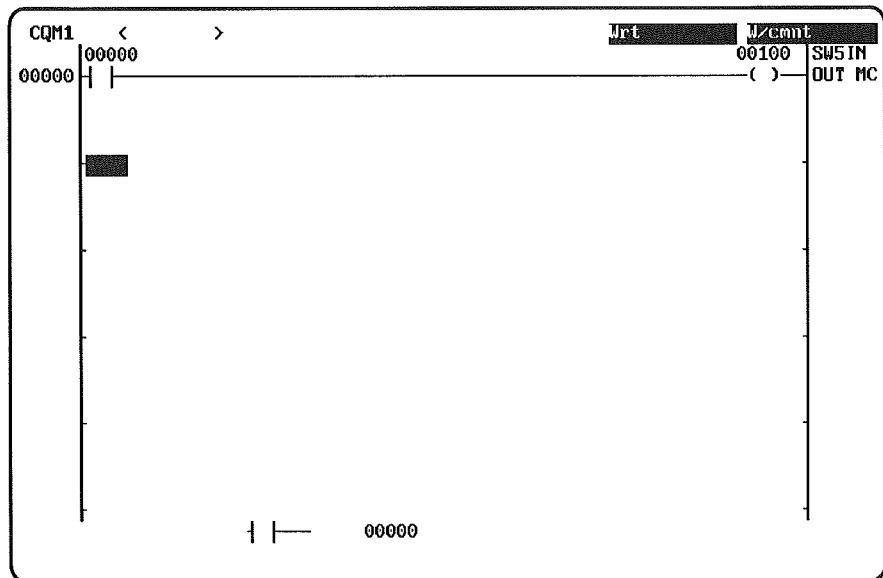

2. Press the F2 Key to go into the Write mode.

- Press the End Key and select "G:Block comment." The block comment at the beginning of the comments that were retrieved will be displayed.

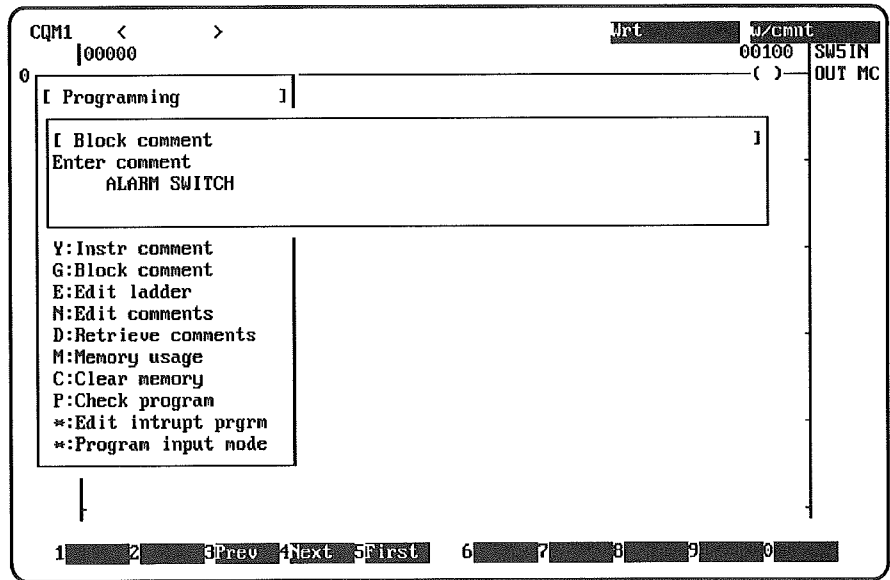

- If the block comment that is currently displayed is the one that is to be copied, then press Enter. If it is a different one that is to be copied, then use the function keys as explained in the following table.

|    |          |  |
|----|----------|--|
| F3 | Previous | Reads the block comment just before the one that is currently displayed. |
| F4 | Next     | Reads the block comment just after the one that is currently displayed.  |
| F5 | First    | Reads the first block comment.   |

- After finding and displaying the desired block comment by using the function keys, press Enter. The comment will be copied to the right of the output at the cursor position. It is possible to edit the comment before pressing Enter. The block comment extends over two lines, and the second line will be displayed the first time Enter is pressed. Press Enter again to display the block comment at the blank line where the cursor is positioned.
- Press the F3 Key followed by Enter to store the comment. To copy other block comments, repeat steps 1 to 5 above.

## 2-5 Searching in Ladder Diagrams

This section explains how to search ladder programs for various items. Searching is performed from the Read mode. Be sure that you are in the Read mode before attempting a search.

### 2-5-1 Searching and Reading Ladder Diagrams

A program in the system work area can be searched for specified contents to display those contents on the screen. The following search operations can be carried out:

- Finding a specified program address
- Finding a basic instruction and bit address
- Finding a bit address
- Finding corresponding input and output instructions using same bit operand
- Finding an instruction from its function code



- Finding an instruction with specific operands
- Finding an I/O comment
- Finding a block comment

**Read Mode Screen**

Ladder diagram searching and reading is carried out in Read mode. To switch from Write mode to Read mode, press the F1 Key.

The Read mode screen is shown in the following illustration. A display in the upper right-hand corner of the screen indicates that it is the Read mode. The search items are shown at the bottom of the screen. The display changes to show more search items when the Shift Key is pressed.

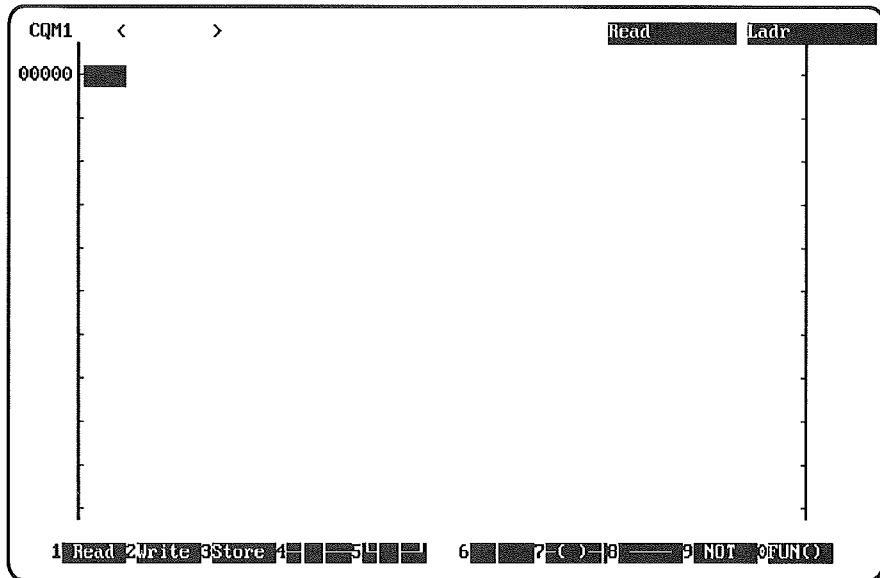

Use the PgUp and PgDn Keys to display the instruction blocks before and after the one that is currently displayed.

| Key  | Description                          |
|------|--------------------------------------|
| PgDn | Read the next instruction block.     |
| PgUp | Read the previous instruction block. |

If the instruction block that was found does not fit on a single screen, use the Up and Down Cursor Keys to move the cursor to display the rest.

| Key         | Description   |
|-------------|---|
| Down Cursor | Press the Down Cursor Key when the cursor is on the bottom line of the screen to display the next instruction line. |
| Up Cursor   | Press the Up Cursor Key when the cursor is on the top line of the screen to display the previous instruction line.  |

The number of instruction lines that can be displayed at one time on a screen for each of the two ladder display modes are shown in the following table.

| Display mode       | Number of instruction lines/screen |
|--------------------|------------------------------------|
| Ladder diagram     | 11                                 |
| Ladder w/ comments | 5                                  |

To abort the search operation before it is finished, press the Escape Key.

To display the instruction block that was found just prior to the one that is presently displayed on the screen, press the Tab Key.

If an instruction block consisting of more than 22 lines is read, the display mode will automatically switch to mnemonic. If that occurs, use "H:Change display" in the Pro-

gramming Menu to switch the display mode back to a ladder mode before displaying the next instruction block.

When there is an END instruction in a program that is searched, the search will stop when the END instruction is reached. If the search is continued past the END instruction, a "Need an END" message will be displayed in the upper left corner of the screen.

When the search is completed, one of the following messages will be displayed.

| Message             | Search type                       | Method for continuing search  |
|---------------------|-----------------------------------|---|
| Last screen         | Search other than from main menu. | To search again for the same item, press Enter. The search will begin from program address 00000.<br>To search for a different item, repeat the procedure from the beginning. |
| No such instruction | Search from main menu.            | To search again for the same item, repeat the procedure from the beginning.   |

**Procedure 1: Searching for Program Addresses**

- 1, 2, 3...
1. If not already in Read mode, press the F1 Key to go into Read mode.
  2. Press the Escape Key, and input the program address that is to be read ("100" in this example). Then press Enter. The instruction block that includes the specified program address will be displayed.

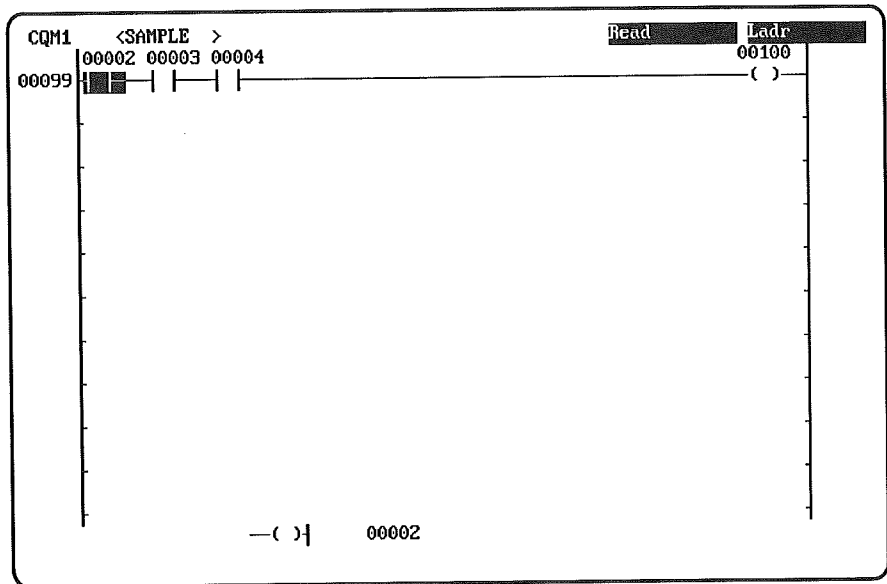

Procedure 2: Searching for Bit Addresses

- 1, 2, 3... 1. Press Control+F9 to specify that a bit address will be entered.

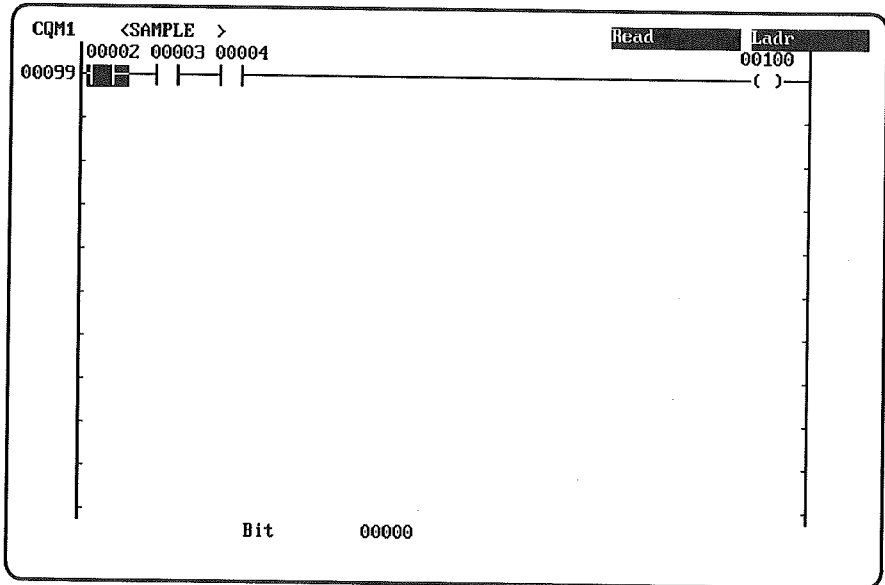

2. Input the bit address ("100" in this example), and then press Enter.  
 3. The search will begin from program address 00000. While the search is in progress, a message will flash on the screen. The instruction block that includes the specified bit address will then be displayed. All instructions with that bit address as an operand will be found in the search.

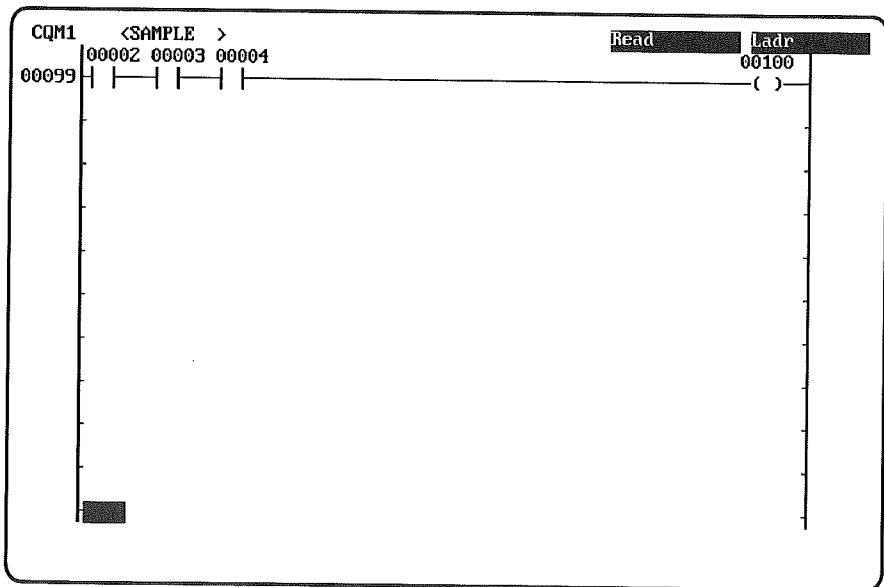

4. To continue searching the rest of the program for the same bit address, press Enter.  
 5. Press the PgDn Key to display the next instruction block, and press the PgUp Key to display the previous one. The original instruction block will remain on the screen if space allows.

**Procedure 3: Finding a Specified Basic Instruction and Bit**

- 1, 2, 3... 1. Press either the F4 Key or the F7 Key to enter a symbol. In this example, press the F4 Key.

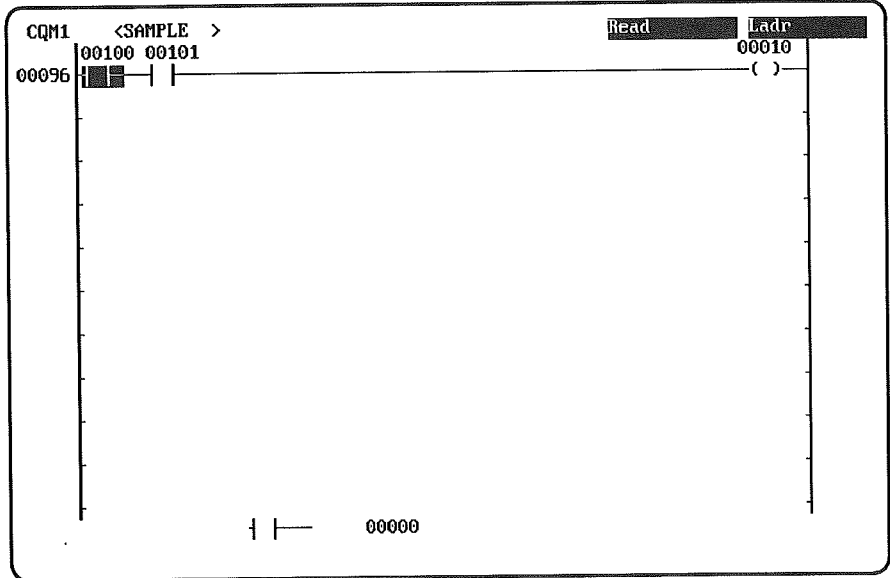

2. Input the bit address ("100" in this example), and then press Enter.  
 3. The search will begin from program address 00000. While the search is in progress, a message will flash on the screen. The instruction block that includes the specified instruction and bit address will be displayed.

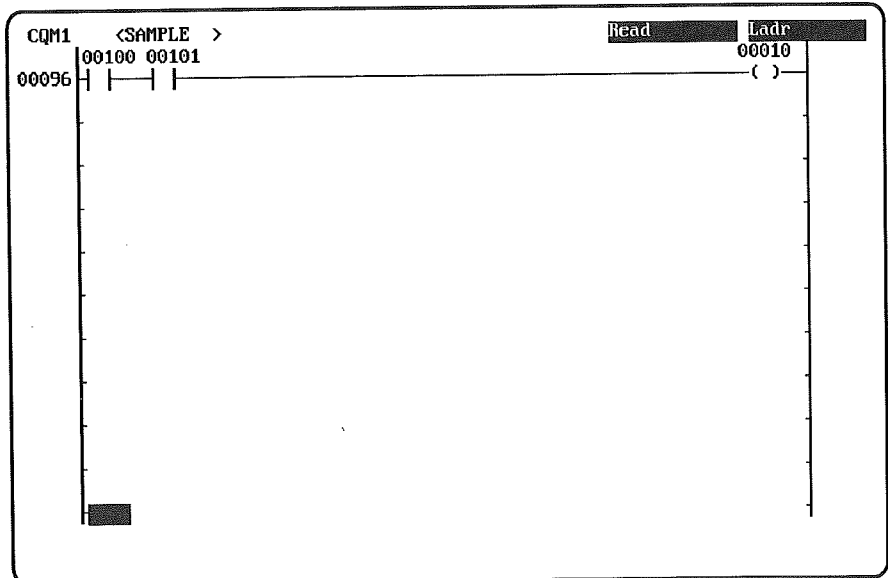

4. To continue searching the rest of the program for the same input condition or output, press Enter.  
 5. Press the PgDn Key to display the next instruction block, and press the PgUp Key to display the previous one. The original instruction block will remain on the screen if space allows.

**Note** The following instructions will be found if an OUTPUT instruction is specified for the search: OUT, OUT NOT, KEEP, DIFU, DIFD, SET, RSET, STEP, and SNXT.

**Procedure 4:  
Finding  
Corresponding  
Input/Output  
Bits**

This procedure can be used to find input and output instructions that have the same bit as an operand.

Move the cursor to the input bit instruction and press Enter. The corresponding output bit will then be found. In this example, output for IR 00100 in line 00099 is found.

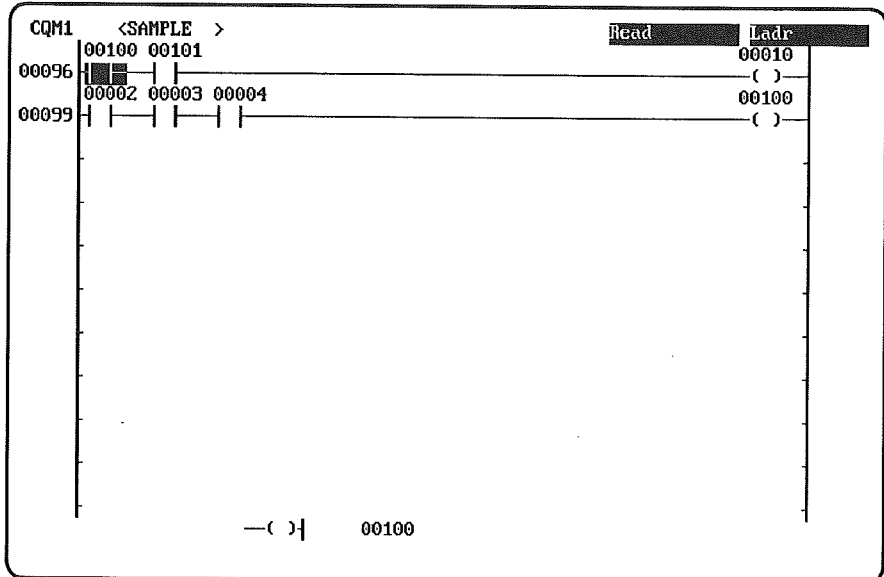

The procedure is the same when searching from an output to an input instruction with the same bit address.

**Procedure 5:  
Finding  
Instructions via  
Function  
Codes**

When searching for a particular function code, input all digits of the function code.

**Instructions With Function Codes**

Input F10, followed by "20" and Enter.

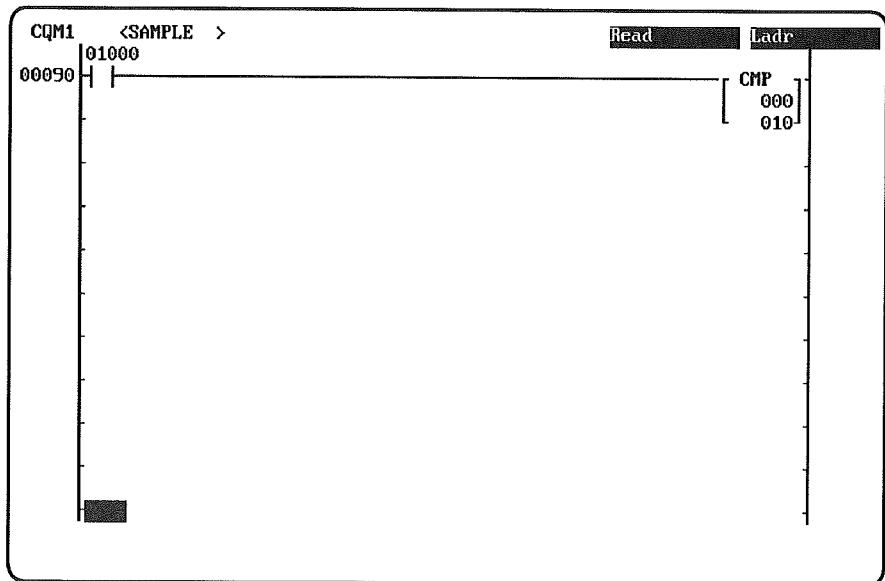

**Differentiated Instructions (with @)**

Input as follows: F10 *Function\_code* (@, F9, or I) (*Operands*) Enter

**Block Programming Instructions (with <>)**

Input as follows: **Shift+F10** *Function\_code* (*Operands*) (**F9**) **Enter**

**Procedure 6: Searching by Function Code and Operand(s)**

- 1, 2, 3... 1. Press the End Key to display the Programming Menu, and then select "K:Search." The following menu will appear.

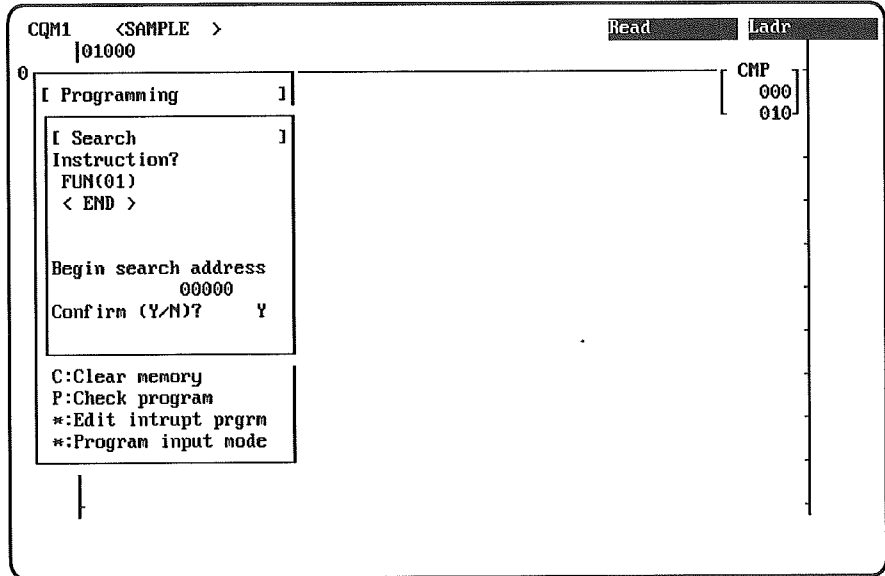

2. To continue searching for the same function code, press "Y." To search for a different function code, first input "N" and press Enter. Then move the cursor to the position of the function code.
3. Input the function code. (For this example, input "21.") The instruction mnemonic inside of the brackets will change automatically (to "MOV" in this example), and the cursor will move to the first operand position.

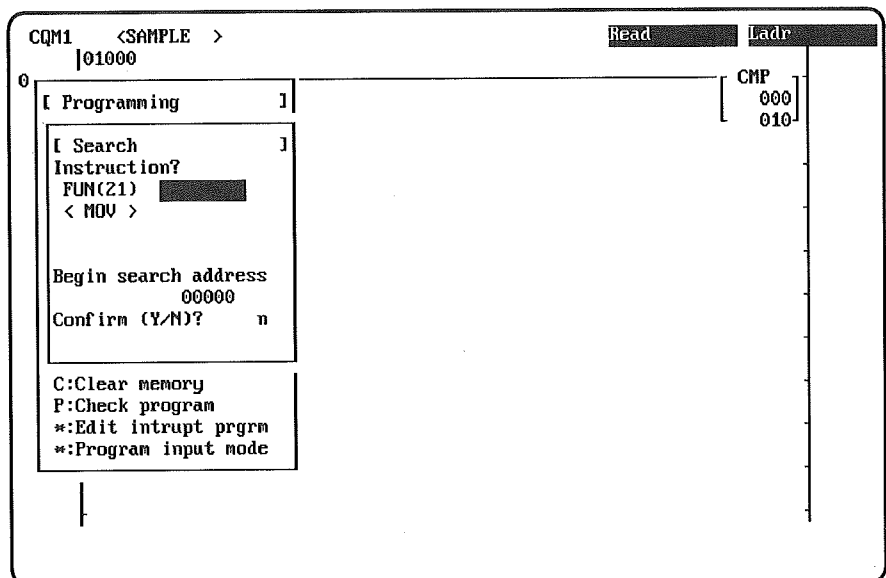

4. To move to the second operand position, press Enter.

- For this example, input "DM0001" by pressing Control+F4 to specify DM and then inputting "1" and pressing Enter. (If the wrong number is input by mistake, clear the number by pressing the Home Key before pressing Enter., then input the number again and press Enter.) The cursor will move to the position for specifying the program address.

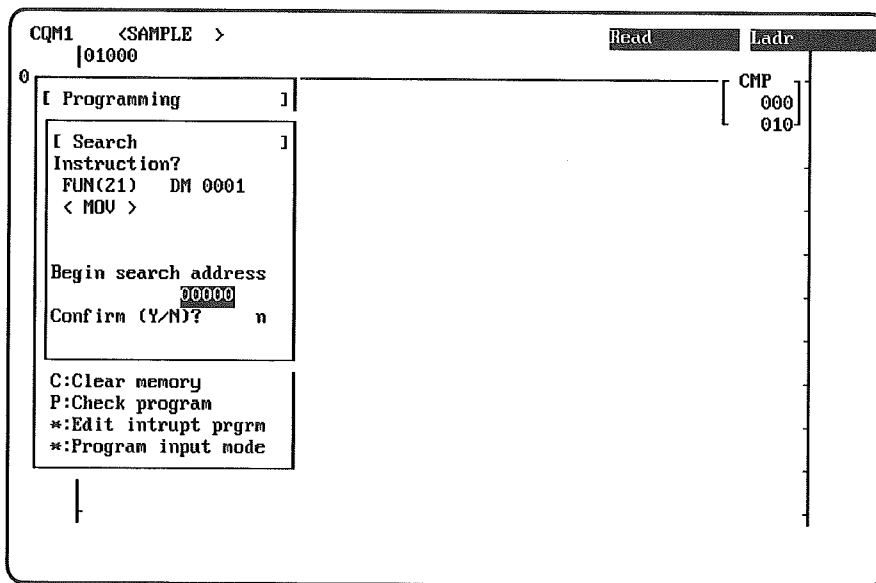

- Input the program address where the search is to begin, and then press Enter. In this example, the search is to begin at 00000, so just press Enter.
- A message will ask for confirmation. To begin the search, just press Enter. To cancel the operation, input "N" and press Enter.

### 2-5-2 Finding I/O Comments and Block Comments

Programs can be searched for specified I/O comments or block comments, and displayed on the screen. (Searches cannot be carried out for instruction comments.)

When searching for I/O comments, instruction blocks containing any bit addresses with an I/O comment that starts with the specified character string will be found and displayed.

When a search is carried out for a specified block comment, the block comment that starts with the specified character string will be found and displayed.

| Key input | Display | Search instructions                  |
|-----------|---------|--------------------------------------|
| F1        |         | LD, LD NOT, AND, AND NOT, OR, OR NOT |
| F2        |         | OUT, OUT NOT                         |

The search is carried out in the "Ladder w/ comments" display mode.

The search will begin from program address 0000. When there is an END instruction in a program that is searched, the search will stop when the END instruction is reached. If the search is continued past the END instruction, a "Need an END" message will be displayed in the upper left corner of the screen. When the last page is reached, a message will be displayed indicating that is the last page.

#### Procedure 1: Finding I/O Comments

- 1, 2, 3... 1. Select "H: Change display" from the Programming Menu, and then specify the "C:Ladder w/ comments" display format.
2. Press the F1 Key to go into the Read mode.

3. Select "I:I/O comment" from the Programming Menu. An input area will appear.
4. Input the I/O comment that is to be found (or the text string from the beginning of the I/O comment), and press Enter. (Example: Input "ABC" followed by Enter.) The bit address will be displayed at the bottom of the screen along with the I/O comment. If there is no I/O comment that corresponds to the character string that has been input, a message will appear on the screen to inform the user of that.
5. If the specified character string has been used for more than one I/O comment, you can find the next occurrence by pressing the F5 Key. The search can also be narrowed by means of the F1, F2, and F4 Keys to specify the type of .
6. Press Enter. The search will then begin from program address 00000. When the specified bit address is found, the first instruction block containing that bit address will be displayed on the screen.
7. To continue the search through the rest of the program, press Enter again.

To return at any point to the previous instruction block that was displayed (i.e., the last one that was found), press the Tab Key. To display the instruction blocks just before and after the one that is currently being displayed, use the PgDn and PgUp Keys respectively.

To carry out another search starting from program address 00000, repeat the procedure from step 3 above.

**Procedure 2: Finding Block Comments**

- 1, 2, 3... 1. Select "H: Change display" from the Programming Menu, and then specify the "C:Ladder w/ comments" display format.
2. Press the F1 Key to go into the Read mode.
3. Select "G:Block comment" from the Programming Menu. An input area will appear.
4. Input the block comment that is to be found (or the text string from the beginning of the comment), and press Enter. (Example: Input "ABC" followed by Enter.)
5. Press Enter. The search will then begin from program address 00000. When the specified block comment is found, it will be displayed on the screen.

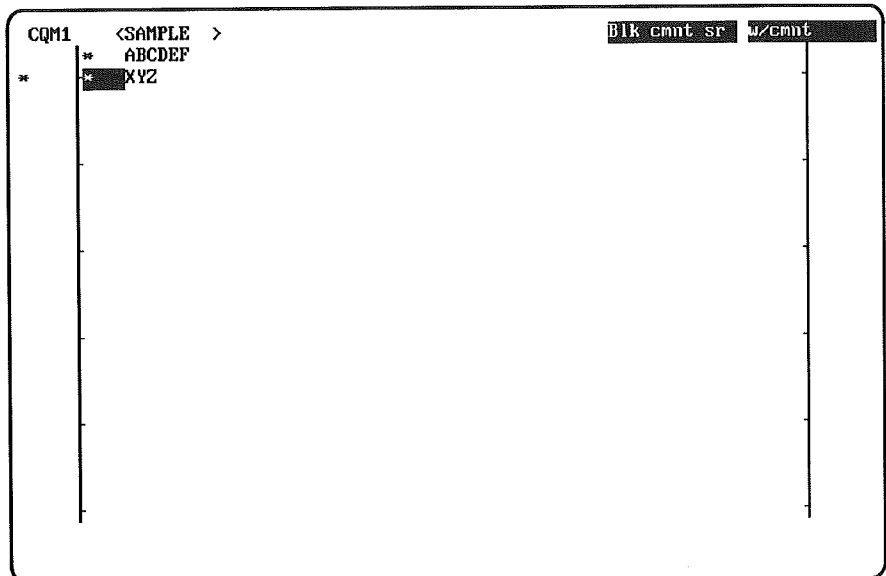

The block comment will be treated as a single instruction block, from the first line that is denoted with an asterisk (\*) before it, in the program address position, to the next line marked by an asterisk. If there is no subsequent asterisk, the continuing block comment will be treated as a single instruction all the way to the end.



When a block comment is specified for a search, the search object will be only the first line of the block comment which is denoted by an asterisk in the program address position.

6. To continue the search through the rest of the program, press Enter again.

To return at any point to the previous instruction block that was displayed (i.e., the last one that was found), press the Tab Key. To display the instruction blocks just before and after the one that is currently being displayed, use the PgDn and PgUp Keys respectively.

To carry out another search starting from program address 00000, repeat the procedure from step 3 above.

### 2-5-3 Summary of Ladder Search/Read Operations

The following table summarizes the methods for searching and reading ladder programs.

| Operation  | Key sequence  | Description  |
|--|---|--|
| Reading a specified program address  | <b>Esc Address Enter</b>  | It is not necessary to input leading zeros, e.g., input address 00000 as 0. The instruction block containing the specified address will be displayed on the screen.  |
| Finding a specified condition or output                                      | Specifying an input condition:<br><b>F4 Bit_address Enter</b><br>Specifying an OUTPUT:<br><b>F7 Bit_address Enter</b> | It is not necessary to input leading zeros. F4 finds and reads the following: LD, LD NOT, AND, AND NOT, OR, OR NOT. F7 finds and reads the following: OUT, OUT NOT. For TIM/CNT, press Control+F6 or Control+F5 for the bit address, and input the timer or counter number.  |
| Searching for bits   | <b>Ctrl+F9 Bit_address Enter</b>  | Searches for all instructions using the specified bit. It is not necessary to input leading zeros. While the search is in progress, "00000" is displayed at the bottom of the screen.  |
| Finding an output for the same input bit or an input for the same output bit | Move cursor to desired input condition/output <b>Enter</b>  | Select a condition or output with the cursor to find the corresponding output or condition. If LD, LD NOT, AND, AND NOT, OR, or OR NOT is specified, the OUT or OUT NOT with the same bit will be found. If OUT or OUT NOT is specified, the LD, LD NOT, AND, AND NOT, OR, OR NOT with the same bit will be found. |

| Operation                                     | Key sequence   | Description   |
|---|--|---|
| Finding an instruction from its function code | Non-differentiated instructions:<br><b>F10 Function_code (Operand) Enter</b><br>Differentiated instructions (with @)<br><b>F10 Function_number (@, I, or F9) (Operand) Enter</b><br>Block program instructions (with < >)<br><b>Shift+F10 Function_number (Operand) (F9) Enter</b> | Input all leading zeros of the function code.<br>For block program instructions and function codes 4 to 15, 91, 92, 94, and 97, input the operand(s) before pressing Enter.<br>While the prompt FUN(??) or FUN<??> is displayed, press Enter or the Control+F Keys to display a table of instructions. Select the required instruction with the cursor and press Enter. The selected instruction will be displayed at the bottom of the screen.<br>Press Enter to start the search.   |
| Finding instructions with specified operands  | Input steps 1 through 7 in order.<br>(1) <b>End</b><br>(2) <b>K</b> (or select with cursor)<br>Search menu will appear.<br>(3) <b>N Enter</b><br>(4) <b>Function_code Enter</b><br>(5) <b>Operand Enter</b><br>(6) <b>Start_program_address Enter</b><br>(7) <b>Enter</b>          | Input all leading zeros of the function code.<br>Either one or several operands can be specified.<br>Execute step 5 at left with the cursor at the position of the operand that is to be specified.<br>Input Control+F9 for instructions using bit addresses as operands, and Control+F7 for instructions using word addresses as operands.<br>For block program instructions, instructions without operands, and function codes 4 to 15, 91, 92, 94, and 97, use the method explained above for finding an instruction from its function code. |

## 2-6 Editing Instruction Blocks

This section explains how use the “E:Edit ladder” operation to move, copy, and delete instruction blocks within ladder programs in the system work area.

### 2-6-1 Moving, Copying, and Deleting Instruction Blocks

Programs in the system work area are edited directly, so there is no need to store them after editing with this operation.

Block comments can be moved, copied, and deleted in increments of instruction blocks. A block comment will be treated as a single instruction block, from the first line that is denoted with an asterisk (\*) before it, in the program address position, to the next line marked by an asterisk. If there is no subsequent asterisk, the continuing block comment will be treated as a single instruction block all the way to the end.

I/O comments and instruction comments will be moved, copied, and deleted together with instruction blocks. Even when an instruction block is deleted, however, the I/O comments will remain as data in the I/O comment area of the system work area.

Block and mnemonic programs within a ladder program are treated as a single block and must be moved as a single unit when editing with this operation.

#### Specifying the Range to be Edited

To specify the range of the program that is to be moved, deleted, or copied, specify the starting and end program addresses, and the destination address for moving or copying. When editing a program, be careful regarding the following points.

- The starting program address must be less than or equal to the end program address.
- If the starting address is equal to the end address, only that one instruction block will be edited.
- The destination address for moving or copying cannot be between the starting address and the end address.

- When moving or copying an instruction block to the end of the program, press the PgDn Key until the final instruction block is displayed. Then press the PgDn Key again so that a message is displayed at the upper left of the screen indicating that it is the final screen. The move or copy operation can then be executed by pressing Enter.

**Editing Operations**

The following table shows the three editing operations that can be carried out using "E:Edit ladder," with an example of each operation.

| Mode   | Execution | Order   |
|--------|-----------|---|
| Move   |           | <p>Starting address B</p> <p>↓</p> <p>End address C</p> <p>↓</p> <p>Blocks movement</p> |
| Copy   |           | <p>Starting address B</p> <p>↓</p> <p>End address C</p> <p>↓</p> <p>Blocks movement</p> |
| Delete |           | <p>Starting address B</p> <p>↓</p> <p>End address C</p>                                 |

Reading and searching for program addresses or instructions can be useful when editing programs. For details, refer to 2-5 Searching in Ladder Diagrams.

Procedure

- 1, 2, 3... 1. Select "E:Edit ladder" from the Programming Menu.

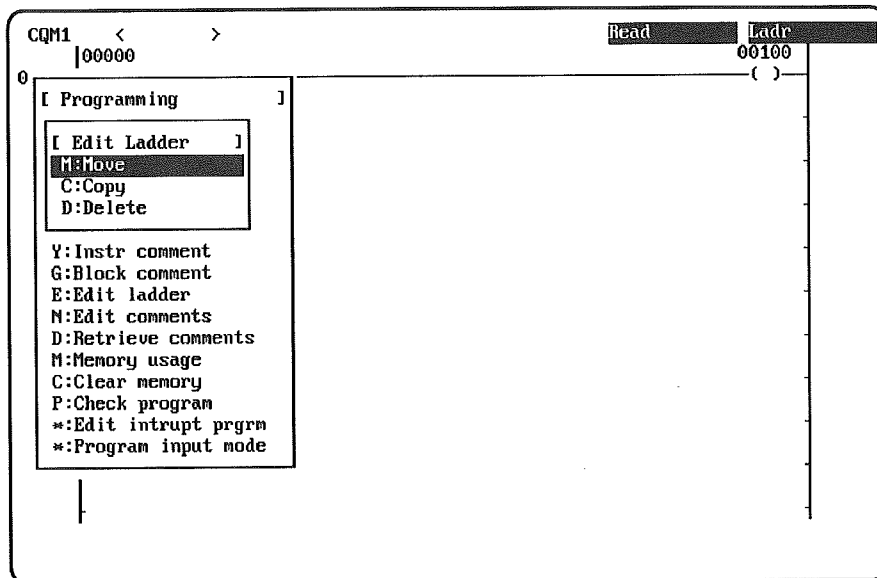

2. Select the operation that is to be executed. The area for setting the starting, end, and destination program addresses will be displayed in the lower right corner of the screen.

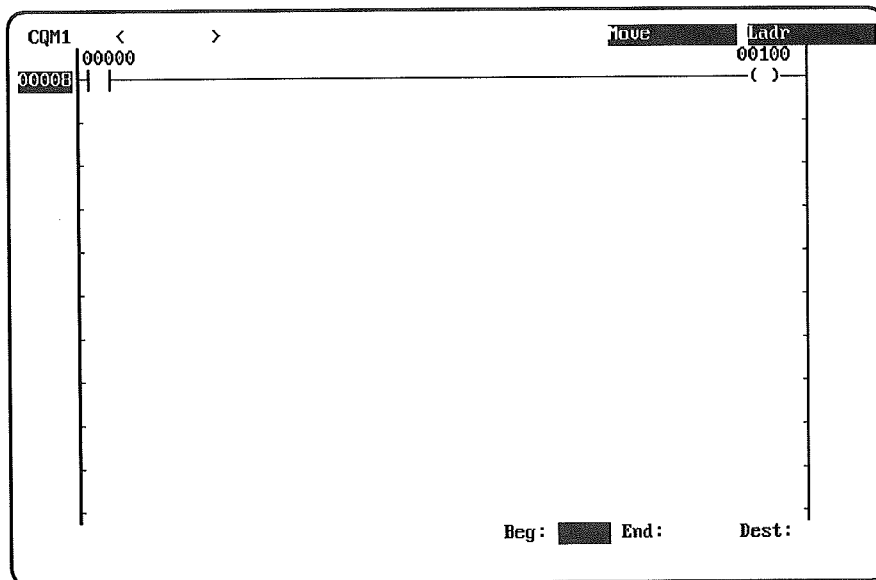

3. Move the cursor to the program address position and press Enter. Use the PgUp and PgDn Keys to scroll the screen, and use the Up and Down Cursor Keys to move the cursor within a screen.
4. To move or copy an instruction block to the end of the program, press the PgDn Key until the final instruction block is displayed. Then press the PgDn Key again so that a message is displayed at the upper left of the screen indicating that it is the final screen. The move or copy operation can then be executed by pressing Enter.

## 2-7 Editing I/O Comments

This section explains how to use the “N:Edit comments” operation. This operation edits I/O comments on the screen in all program formats and edit modes by finding and rewriting the specified comments. It does not, however, edit instruction or block comments.

### 2-7-1 Comment Editing Operations

I/O comments are comments assigned to specific bit addresses. A list of I/O comments can be displayed on the screen for each data area. Once I/O comments have been written or edited, they are automatically written to the system work area, so there is no need to store them.

**Caution** While I/O comments are being edited, do not turn the power supply off or press the reset button. Doing so may damage the I/O comment area in the system work area.

**Inputting I/O Comments** Up to 16 characters can be input for a single I/O comment. Any numbers or letters can be used.

**Comment Editing Screen** To bring up the screen for editing I/O comments, first select “N:Edit comments” from the Programming Menu. Then use either alphanumeric keys or the cursor to select the data area and word.

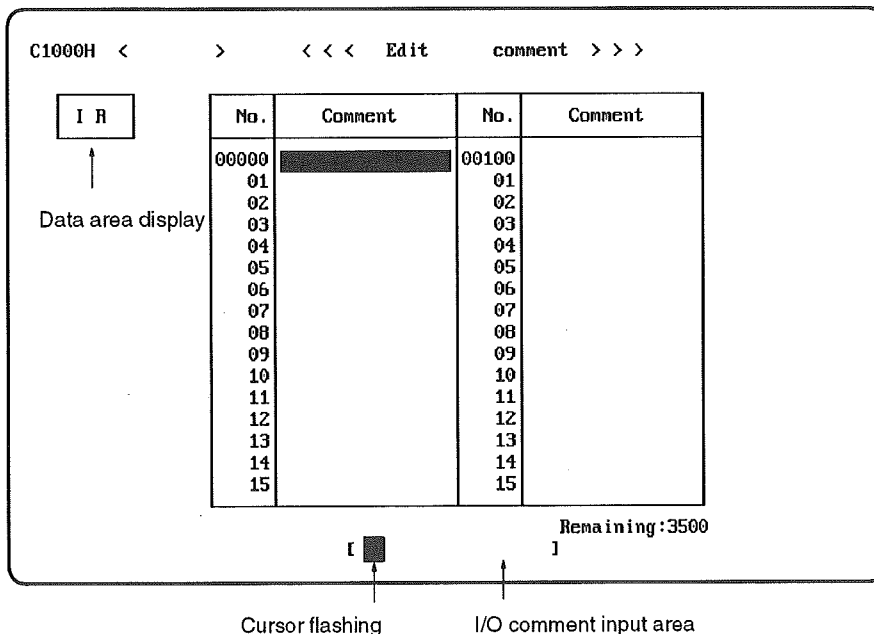

A maximum total of 3,500 I/O comments can be set, with up to 32 displayed on the screen at a time. Use the PgUp Key to display the previous screen, and the PgDn Key to display the next screen. Use the Up and Down Cursor Keys to move the cursor to bit addresses, and the Right and Left Cursor Keys to move the flashing cursor inside of the I/O comment input area.

I/O comments edited here are displayed on both ladder and mnemonic screens.

**Edit Comment Menu** In addition to editing comments one by one, commands on an Edit Comment Menu can also be used. To access this menu, press the End Key (or Control+M) while in the comment editing screen shown above.

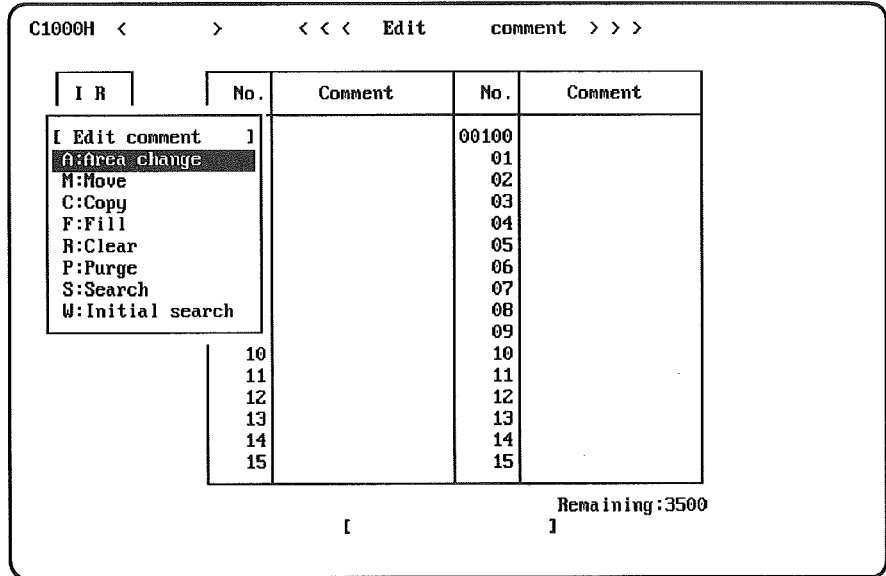

The following table gives a summary of the commands in the Edit Comment Menu.

| Command          | Function  |
|------------------|---|
| A:Area change    | Changes the data area being displayed on the screen for editing.  |
| M:Move           | Moves specified I/O comments within the same data area or to a different data area.   |
| C:Copy           | Copies and moves specified I/O comments within the same data area or to a new data area.  |
| F:Fill           | Adds the same comment to specified bits or words within the same data area.   |
| R:Clear          | Clears all comments in a specified data area.   |
| P:Purge          | Clears all bit-address I/O comments which are not being used in the program in the system work area. Also clears all word-address I/O comments in all areas regardless of whether or not they are being used. |
| S:Search         | Finds and displays the specified comment.   |
| W:Initial search | Finds and displays all comments which begin with a specified character.   |

### 2-7-2 Writing and Modifying I/O Comments

Follow this procedure to write and modify I/O comments for particular bits.

- 1, 2, 3... 1. Select "N:Edit comments" from the Programming Menu.

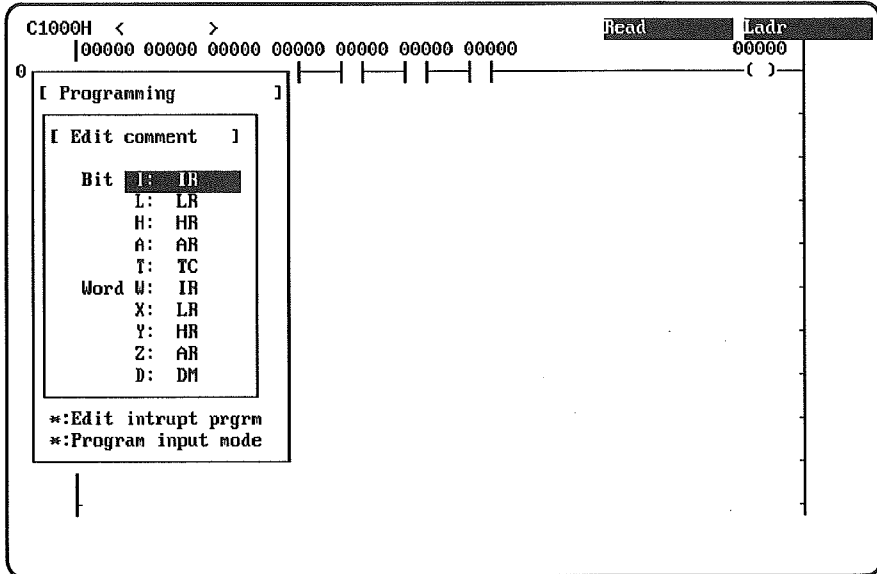

2. Select the data area according to whether the I/O comment is associated with a bit or word address.  
 3. For this example, press Enter to select the I/O area for bit addresses. The display for editing I/O comments in this area will then be displayed.

At the bottom of the screen, a cursor will flash in the area for inputting the I/O comment. If an I/O comment is already set for that address, it will be displayed.

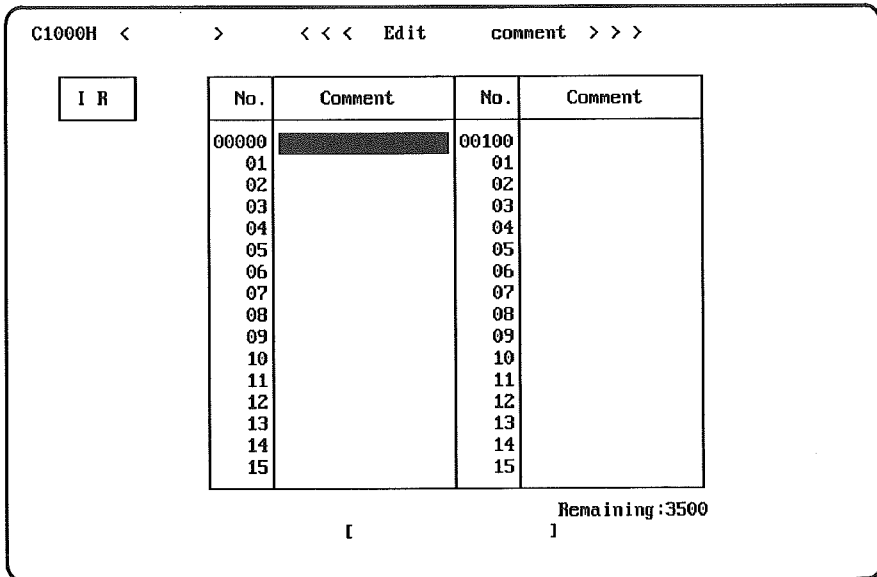

4. Input a new I/O comment or change the existing one. For this example, input "TEST1" and press Enter. The new or revised comment will then be written in the list.

5. Move the cursor to the next line. Follow the same procedure as before to input this and subsequent I/O comments.
6. To specify another data area or address, press the End Key (or Control+M) while in the comment editing screen. The Edit Comment Menu will appear.
7. Select "A:Area change" from the menu, and input the data area and address. Then follow the same procedure as explained above.
8. To return to the Programming Menu, press the Escape Key.

### 2-7-3 Moving and Copying I/O Comments

**Procedure 1:**  
**Moving I/O**  
**Comments**

1, 2, 3...

Follow this procedure to move an I/O comment and assign it to another bit or word.

1. Select "N:Edit comments" from the Programming Menu. Then select the bit or word area. While the comment editing screen is displayed, press the End Key to bring up the Edit Comment Menu.
2. Select "M:Move" from the Edit Comment Menu.

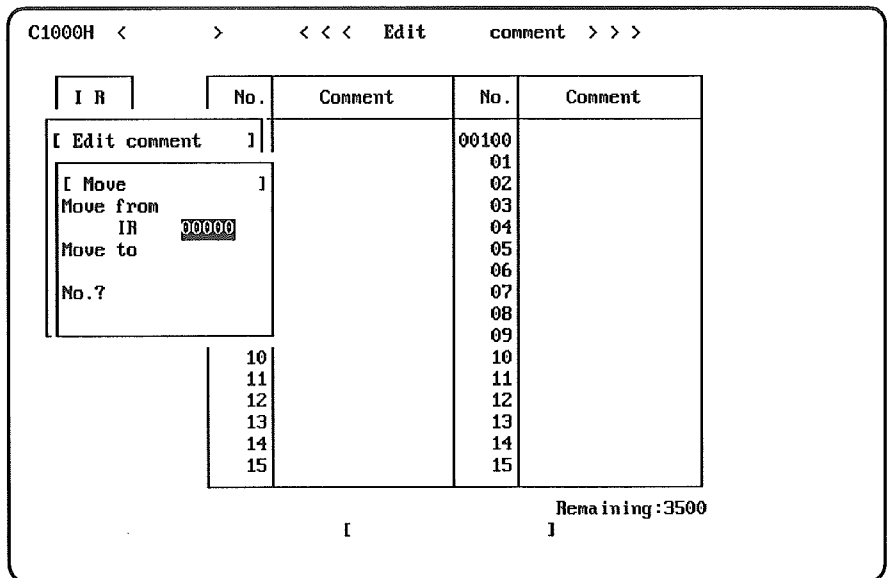

3. To move an I/O comment for a bit in the I/O area, just input the bit address and press Enter. To move a comment for a bit in another area, first change the display according to the following table.

| Data area    | Key sequence                                 |
|--------------|--|
| I/O          | <i>Bit_address</i> Enter                     |
| LR           | Ctrl+F3 <i>Bit_address</i> Enter             |
| HR           | Ctrl+F2 <i>Bit_address</i> Enter             |
| AR           | Ctrl+F1 <i>Bit_address</i> Enter             |
| TIM/CNT      | Ctrl+F6/F5 <i>Timer/counter_number</i> Enter |
| Word address | Ctrl+F7 plus the same key inputs as above.   |
| DM           | Ctrl+F7, Ctrl+F4 <i>DM_address</i> Enter     |

4. Input the source bit, and press Enter.
5. Input the destination bit, and press Enter. The data area for the destination can be different from that of the source.



- Input the number of I/O comments to be moved (for this example, input "2") and then press Enter. The specified I/O comments will be moved. If there are no I/O comments in the source area, the I/O comments in the destination area will not be affected.

**Procedure 1:  
Copying I/O  
Comments**

Follow this procedure to copy an I/O comment to another bit or word.

1, 2, 3...

- Select "N:Edit comments" from the Programming Menu, and then select the data area. While the comment editing screen is displayed, press the End Key to bring up the Edit Comment Menu.
- Select "C:Copy" from the Edit Comment Menu.

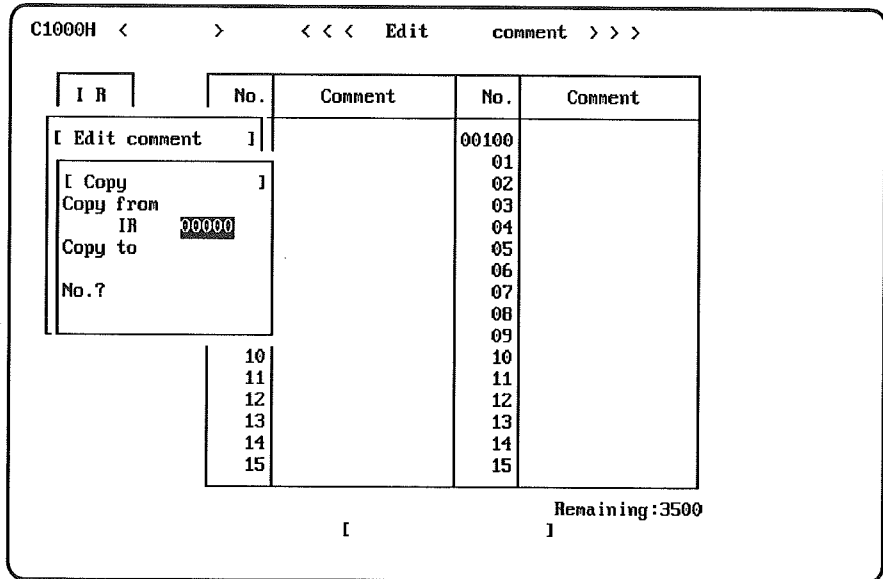

- From this point onward, the procedure is the same as for the move operation outlined in Procedure 1, above, but the original comments are left as they unchanged.

### 2-7-4 Clearing I/O Comment Data

Follow this procedure to clear I/O comment data for a bit or word.

- 1, 2, 3...
1. Select "N:Edit comments" from the Programming Menu. Then select the data area. While the comment editing screen is displayed, press the End Key to bring up the Edit Comment Menu.
  2. Select "R:Clear" from the Edit Comment Menu.

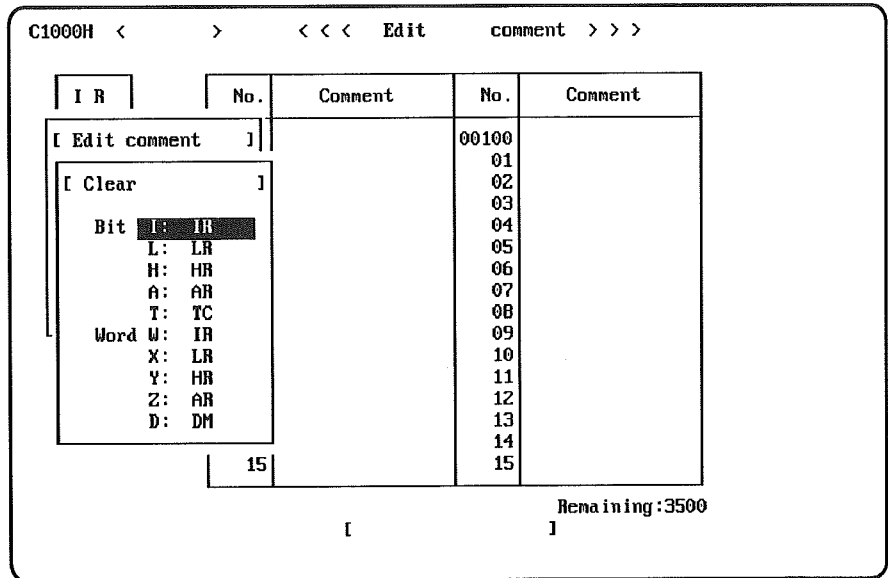

3. Use a key input or the cursor to select the area that is to be cleared. A message will appear on the screen to ask for confirmation.
4. To clear the area, input "Y" and press Enter. To cancel the operation, just press Enter. If the operation is carried out, all of the I/O comments in the specified area will be cleared.

### 2-7-5 Writing an I/O Comment to Multiple Addresses

Follow this procedure to simultaneously write the same I/O comment to multiple bits or words.

- 1, 2, 3...
1. Select "N:Edit comments" from the Programming Menu. Then select the data area. While the comment editing screen is displayed, press the End Key to bring up the Edit Comment Menu.
  2. Select "F:Fill" from the Edit Comment Menu.

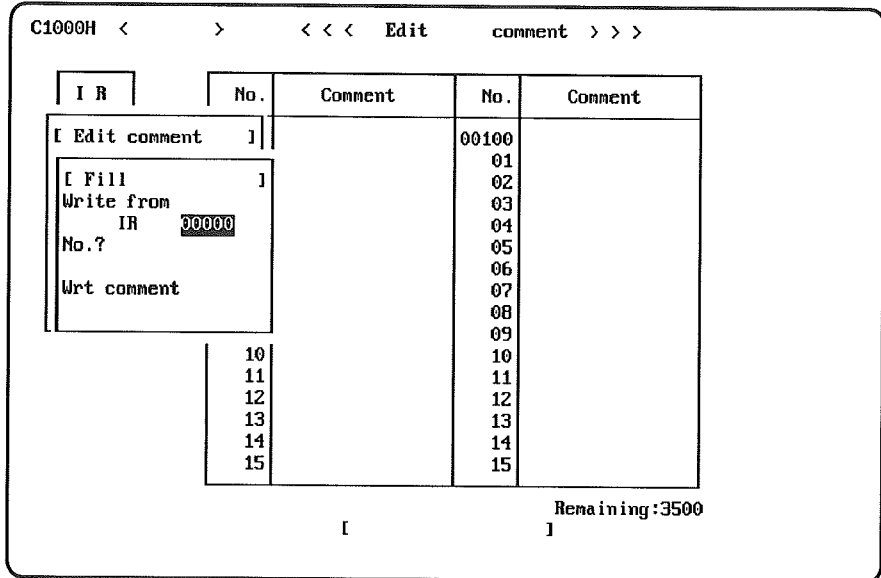

3. Input the starting bit for writing. When specifying a bit in the I/O area, just input the bit address and press Enter. To specify a bit in another area, first change the display according to the table in 2-7-3 *Moving and Copying I/O Comments*.
4. Input the number of bits or words to which the I/O comment is to be written, and then press Enter.
5. Write the I/O comment, using up 16 characters.  
An existing I/O comment can also be used. Press the End Key and then enter the bit or word address. The I/O comment will be displayed. (If the wrong address has been entered, a message will be displayed on the screen.)
6. Press Enter. The I/O comment will be written to the specified range. If no comment has been written, all I/O comments for the destination bits will be deleted.

### 2-7-6 Deleting Unused Comments

The "P:Purge" operation can be used to delete from the user program all I/O comments that are not being used. When this operation is executed, all unused bit I/O comments will be deleted, and all word I/O comments will be deleted regardless of whether or not they are being used.

Since all comments, both used and unused, must be checked, this operation can take several minutes.

#### Procedure

- 1, 2, 3...
1. Select "N:Edit comments" from the Programming Menu. Then select the data area. While the comment editing screen is displayed, press the End Key to bring up the Edit Comment Menu.
  2. Select "P:Purge" from the Edit Comment Menu. A message will appear on the screen to ask for confirmation.

- To delete the comments, just press Enter. To cancel the operation, input "Y" and press Enter. If the operation is carried out, the I/O comments will be cleared. The number of remaining comments displayed in the lower right part of the screen will increase.

### 2-7-7 Finding I/O Comments

The "S:Search" and "W:Initial search" commands can be used to find specified I/O comments. With "S:Search," the entire comment must be input exactly. With "W:Initial search," only the first character in the comment need be input.

- 1, 2, 3... Select "N:Edit comments" from the Programming Menu. Then select the data area. While the comment editing screen is displayed, press the End Key to bring up the Edit Comment Menu.
- Select either "S:Search" or "W:Initial search" from the Edit Comment Menu.

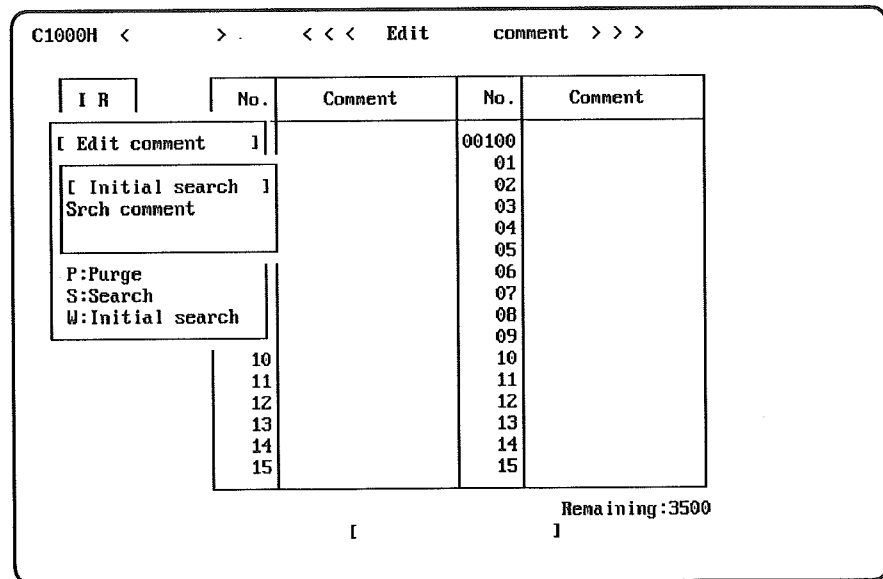
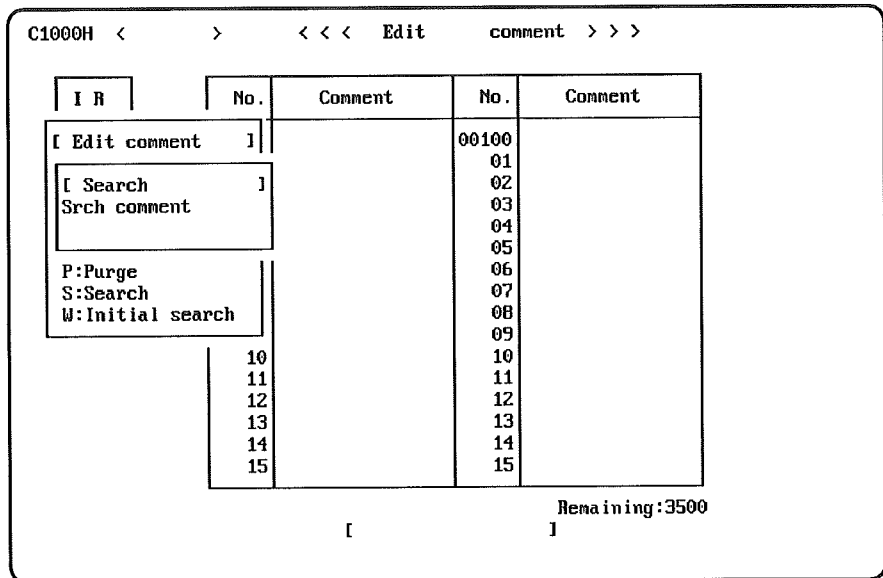

3. Input the data that is to be found. For "S:Search," input the entire comment and then press Enter. For "W:Initial search," input the first character and then press Enter. If there is a comment that matches the comment or initial that was input, the cursor will move to that comment. If there is no comment that matches, a message will appear on the screen to indicate that nothing was found.
4. To continue the search, press the End Key and repeat the procedure from step 2.

## 2-8 Programming in the Mnemonic Mode

This section explains how to program in the mnemonic display mode.

### 2-8-1 Mnemonic Programming

Mnemonic programming allows ladder diagrams to be created in machine language. Mnemonic programs are entered using function keys or mnemonics can be typed from the keyboard.

Ladder programs are input in the mnemonic programming mode. Ladder programs created with ladder instructions in the mnemonic display mode and ladder programs created in the ladder programming modes are identical in the system work area, allowing programs to be created and read in either display mode. To switch between the ladder and mnemonic display modes, use the "H:Change display" command from the Programming Menu.

Programs created in the mnemonic display mode are automatically written to the system work area, so that it is not necessary to use the Store operations (Store and Store Insert).

**Note** Use the "N:Edit comments" operation to create I/O comments. Switch to the "Ladder w/ comments" display mode to create any required block comments or instruction comments, as they cannot be created in the mnemonic display mode. The first 33 characters of a block comment created and stored in the ladder display mode will be displayed on the screen in the mnemonic display mode.

### Preparations

The PC model setting in the System Setup must be set to the PC model for which the program is to be written. Check in advance to be sure that this setting is correct.

Use "C:Clear memory" to delete the contents of the memory before inputting a new program. Existing programs will be overwritten if not deleted before a new program is written.

## 2-8-2 Mnemonic Programming Screen

To access the mnemonic programming screen, select either "N:Mnemonic (F keys)" or "A:Mnemonic (typed)" from the Change Display operation under the Programming Menu

The following screen will appear, with the editing mode and the display mode displayed to the upper right.

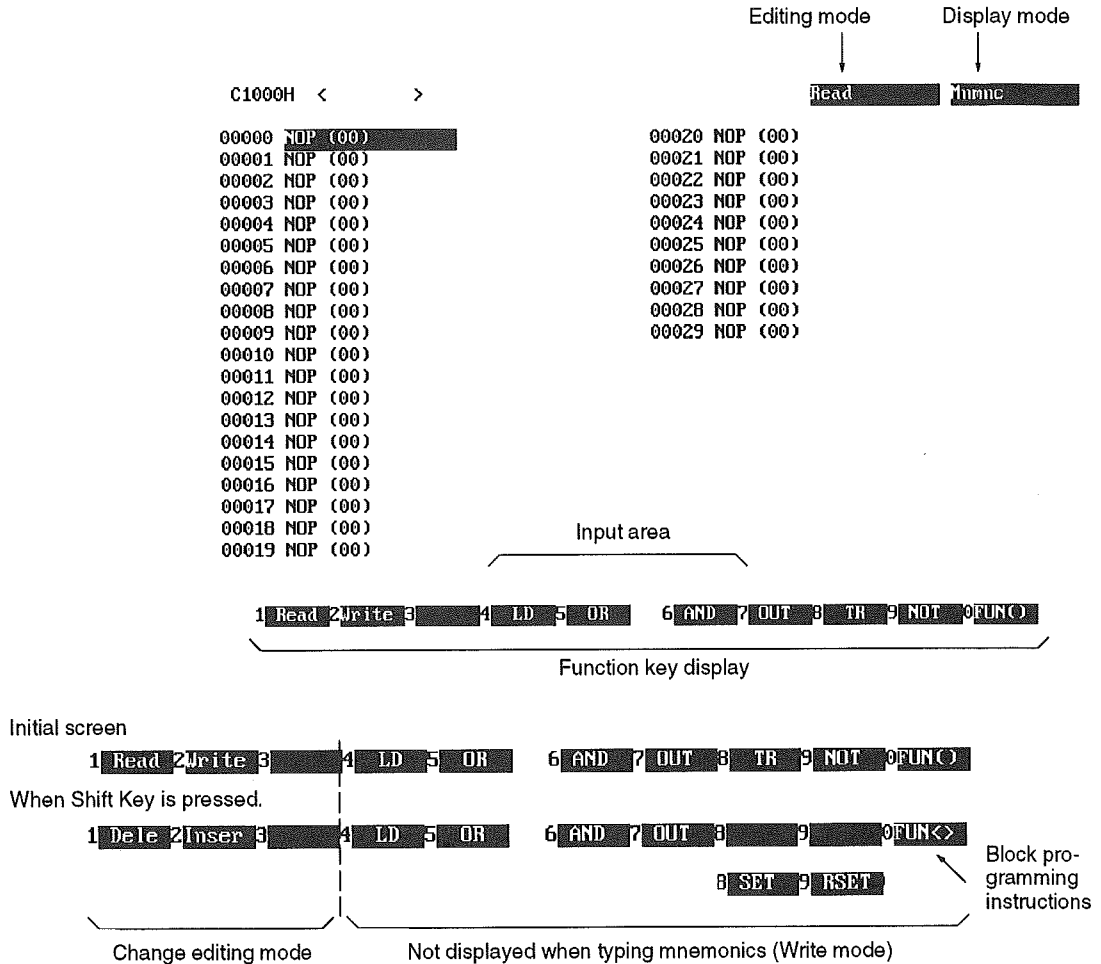

The ten function keys at the bottom of the screen are changed when the Shift Key is pressed. When the PC model in the System Setup is set to either CQM1 or C200HS, Shift+F8 becomes SET, and Shift+F9 becomes RESET.

The editing mode set by the function keys will be displayed in the upper right part of the screen. The initial mode is the Read mode.

Up to 30 lines of read/write area can be displayed on a screen in mnemonic display. There is also a blank area of 10 lines for inserting lines in the program. If the program exceeds 40 lines, you must go onto the next screen.

### Moving the Cursor

The cursor can be moved only in Write mode. There are two ways of moving the cursor: function key input and typing mnemonics.

#### Function Key Input

Press the Up and Down Cursor Keys to move the cursor up and down the display. Press the Right and Left Cursor Keys to move the cursor right and left. Press the PgUp and PgDn Keys to scroll to the previous page and the next page.

**Typing Mnemonics**

Press the Up and Down Cursor Keys to move the cursor up and down the display. When the cursor reaches the bottom or top of one side, it will go to the top or bottom of the other side. (In Delete mode, however, the movement is the same as for function key input.) Press the Right and Left Cursor Keys to move the cursor right and left. Press the PgUp and PgDn Keys to scroll to the previous page and the next page.

**2-8-3 Entering Mnemonic Programs**

There are two ways to enter a mnemonic program. One is to input instructions by means of function keys, and the other is to use typed mnemonics to input mnemonics directly.

Operands, such as bit addresses and timer/counter numbers, must be input after instructions.

**Function Code Input** Use the following procedure to input instructions with function codes.

- 1, 2, 3...**
1. Press the F10 Key or Shift+F10. Either FUN(??) or FUN<??> will be displayed.
  2. Press Enter or press Control+F. A list of instructions will be displayed.
  3. Move the cursor to the instruction that is to be input, and press Enter.

 **Caution** You must check any mnemonic program after inputting it. Even if a mnemonic program is incorrect, no error will be generated and it will be stored as is when input.

**Note** For details regarding function codes, operands, and bit addresses, refer to the relevant C-series manual.

**Mnemonic Input**

The following table shows the key sequences for inputting instructions in mnemonic form, using either function keys or typed mnemonics. All the instructions shown in the "Typing mnemonics" column must be entered using typed mnemonics. For example, "LD" must be entered using the "L" and "D" keys.

| Instruction                                      | Function key input   | Typing mnemonics   |
|--|--|--|
| LD   | <b>F4</b> <i>Bit_address</i> <b>Enter</b>                                      | LD <b>Space</b> <i>Bit_address</i> <b>Enter</b>  |
| OR   | <b>F5</b> <i>Bit_address</i> <b>Enter</b>                                      | OR <b>Space</b> <i>Bit_address</i> <b>Enter</b>  |
| AND  | <b>F6</b> <i>Bit_address</i> <b>Enter</b>                                      | AND <b>Space</b> <i>Bit_address</i> <b>Enter</b>   |
| LD NOT   | <b>F4 F9</b> <i>Bit_address</i> <b>Enter</b>                                   | LD <b>Space</b> NOT <b>Space</b> <i>Bit_address</i> <b>Enter</b>   |
| OR NOT   | <b>F5 F9</b> <i>Bit_address</i> <b>Enter</b>                                   | OR <b>Space</b> NOT <b>Space</b> <i>Bit_address</i> <b>Enter</b>   |
| AND NOT  | <b>F6 F9</b> <i>Bit_address</i> <b>Enter</b>                                   | AND <b>Space</b> NOT <b>Space</b> <i>Bit_address</i> <b>Enter</b>  |
| OR LD  | <b>F5 F4</b> <i>Bit_address</i> <b>Enter</b>                                   | OR <b>Space</b> LD <b>Space</b> <i>Bit_address</i> <b>Enter</b>  |
| AND LD   | <b>F6 F4</b> <i>Bit_address</i> <b>Enter</b>                                   | AND <b>Space</b> LD <b>Space</b> <i>Bit_address</i> <b>Enter</b>   |
| OUT  | <b>F7</b> <i>Bit_address</i> <b>Enter</b>                                      | OUT <b>Space</b> <i>Bit_address</i> <b>Enter</b>   |
| OUT NOT  | <b>F7 F9</b> <i>Bit_address</i> <b>Enter</b>                                   | OUT <b>Space</b> NOT <b>Space</b> <i>Bit_address</i> <b>Enter</b>  |
| LD TR  | <b>F4 F8</b> <i>Bit_address</i> <b>Enter</b>                                   | —  |
| OUT TR   | <b>F7 F8</b> <i>Bit_address</i> <b>Enter</b>                                   | —  |
| TIM (See note 1.)                                | <b>Ctrl+F6</b> <i>Timer_number</i> <b>Enter</b><br><i>SV</i> <b>Enter</b>      | TIM <i>Timer_number</i> <b>Space</b> # <i>SV</i> <b>Enter</b>  |
| CNT (See note 1.)                                | <b>Ctrl+F5</b> <i>Timer_number</i> <b>Enter</b><br><i>SV</i> <b>Enter</b>      | CNT <i>Counter_number</i> <b>Space</b> # <i>SV</i> <b>Enter</b>  |
| Instruction with function code (See note 2.)     | <b>F10</b> <i>Function_code (Operand)</i> <b>Enter</b>                         | <i>Instruction</i> <b>Space</b> ( <i>Operand</i> <b>Space</b> <i>Operand</i> <b>Space</b> <i>Operand</i> ) <b>Enter</b>  |
| Differentiate instruction (with @) (See note 2.) | <b>F10</b> <i>Function_code (@, F9, or I)</i> ( <i>Operands</i> ) <b>Enter</b> | @ <i>Instruction</i> <b>Space</b> ( <i>Operand</i> <b>Space</b> <i>Operand</i> <b>Space</b> <i>Operand</i> ) <b>Enter</b>  |
| Block program instruction (with <>)              | <b>Shift+F10</b> <i>Function_code (Operands)</i> ( <b>F9</b> ) <b>Enter</b>    | <ul style="list-style-type: none"> <li>• <i>Instruction</i> <b>Space</b> (<i>Operand</i> <b>Space</b> <i>Operand</i> <b>Space</b> <i>Operand</i>) <b>Enter</b></li> <li>• FUN <b>Shift+&lt;</b> <i>Function_code</i> <b>Shift+&gt;</b> <b>Space</b> (<i>Operand</i> <b>Enter</b> <i>Operand</i> <b>Enter</b> <i>Operand</i>) <b>Enter</b></li> </ul> |

If the wrong function code is entered, press the F10 Key again and reenter the function code. When using typing mnemonics, input all the instruction's operands on one line and then press Enter.

- Note**
1. To input a set value (SV) from an external device, press Control+F7 to change to the word input display and input address of the input word to be used to set the SV.
  2. Input all digits of function codes. Leading zeros cannot be omitted. For block program instructions and instructions with function codes, 04 to 15, 91, 92, 94, and 97, input the operands before pressing Enter.



## Inputting Addresses and Data in Mnemonic Form

The following tables show how to input bit and word address and other data in mnemonic form, both using function keys and by typing mnemonics. It is not necessary to input the leftmost digits for addresses and numbers. If the wrong address is entered, press the Home Key and then reenter the address.

### Function Key Input

| Data area               | Bit address input                    | Word address input                   | Ladder diagram display |
|-------------------------|--------------------------------------|--------------------------------------|------------------------|
| I/O, IR, SR             | <i>Bit_address</i>                   | <i>Word_address</i>                  | —                      |
| HR                      | <b>Ctrl+F2</b> <i>Bit_address</i>    | <b>Ctrl+F2</b> <i>Word_address</i>   | H                      |
| AR                      | <b>Ctrl+F1</b> <i>Bit_address</i>    | <b>Ctrl+F1</b> <i>Word_address</i>   | A                      |
| LR                      | <b>Ctrl+F3</b> <i>Bit_address</i>    | <b>Ctrl+F3</b> <i>Word_address</i>   | L                      |
| DM                      | —                                    | <b>Ctrl+F4</b> <i>DM_address</i>     | D                      |
| Indirect DM             | —                                    | <b>Ctrl+F8</b> <i>DM_address</i>     | *D                     |
| Timer                   | <b>Ctrl+F6</b> <i>Timer_number</i>   | <b>Ctrl+F6</b> <i>Timer_number</i>   | T                      |
| Counter                 | <b>Ctrl+F5</b> <i>Counter_number</i> | <b>Ctrl+F5</b> <i>Counter_number</i> | C                      |
| Constant<br>(See note.) | —                                    | <b>Ctrl+F10</b> <i>Value</i>         | #                      |

- Note**
1. Leading zeros do not need to be input except for those in function codes.
  2. Press the Home Key to correct input mistakes made before pressing Enter.
  3. For information on inputting BCD (with and without sign), refer to 2-2-4 *Entering Bit/Word Address and Data*.

### Typing Mnemonics

| Data area               | Bit address input         | Word address input                    | Ladder diagram display |
|-------------------------|---------------------------|---------------------------------------|------------------------|
| I/O, IR, SR             | <i>Bit_address</i>        | <i>Word_address</i>                   | —                      |
| HR                      | HR <i>Bit_address</i>     | HR <i>Word_address</i>                | H                      |
| AR                      | AR <i>Bit_address</i>     | AR <i>Word_address</i>                | A                      |
| LR                      | LR <i>Bit_address</i>     | LR <i>Word_address</i>                | L                      |
| DM                      | —                         | DM <i>Word_address</i>                | D                      |
| Indirect DM             | —                         | <b>Shift+*</b> DM <i>Word_address</i> | *D                     |
| Timer                   | TIM <i>Timer_number</i>   | TIM <i>Timer_number</i>               | T                      |
| Counter                 | CNT <i>Counter_number</i> | CNT <i>Counter_number</i>             | C                      |
| Constant<br>(See note.) | —                         | <b>Shift+#</b> <i>Value</i>           | #                      |

- Note**
1. Leading zeros do not need to be input except for those in function codes.
  2. For information on inputting BCD (with and without sign), refer to 2-2-4 *Entering Bit/Word Address and Data*.

### Example: Inputting Instructions by Typing Mnemonics

Input instructions by typing mnemonics and operands from the keyboard (A to Z and 0 to 9). Instructions are always displayed in all capital letters. When inputting an instruction, press the Space Key to separate the mnemonic from operands and operands from operands.

When entering differentiate instructions, first press the @ Key before inputting the instruction.

When inputting bit and word addresses, constants, and so on, for instructions indicated only by their function codes (i.e., instructions without mnemonics), the leftmost digits must be input. If they are omitted, a message will be displayed indicating that the setting is wrong. (The instructions that are indicated only by their function codes vary according to the PC.)

The following tables shows some examples of inputting instructions.

| Keyboard inputs          | Mnemonic code             |
|--------------------------|---------------------------|
| LD_201                   | LD 00201                  |
| OR_NOT TIM24             | OR NOT TIM024             |
| TIM_1_#100               | TIM 001 #0100             |
| MOV _LR1_5               | MOV(21) LR01 005          |
| FUN(21)_0_DM3            | MOV(21) 000 DM 003        |
| @MOV_10_6                | @MOV 010 006              |
| IF_1                     | IF<02> 00001              |
| FUN<02>_1                | IF<02> 00001              |
| FUN(67)_#0003_001_DM0010 | FUN(67) #0003 001 DM 0010 |

**Correcting Inputs**

Use the following keys to edit previously input characters.

| Key        | Function   |
|------------|--|
| Cursor     | Move the cursor left and right along the input area. |
| Backspace  | Deletes the character to the left of the cursor.     |
| Delete     | Deletes the character at the cursor position.        |
| Insert     | Inserts a space at the cursor position.              |
| Home       | Deletes all characters in the character input area.  |
| Shift+Home | Deletes all instructions displayed on the screen.    |

**2-8-4 Writing Mnemonic Programs**

When a program is written in mnemonic form, it is automatically written to the system work area. Be sure to execute "P:Check program" to check the program after it has been written, because no program errors will be detected even if the mnemonic program is incorrect.

**Procedure**

1, 2, 3...

1. Select "H:Change display" from the Programming Menu.
2. Select either "N:Mnemonic (F Keys)" or "A:Mnemonic (Typed)" from the "H:Change display" menu. The one that is selected will be displayed in the upper right part of the screen.
3. Press the F2 Key to go into the Write mode. "Write" will be displayed in the upper right part of the screen.

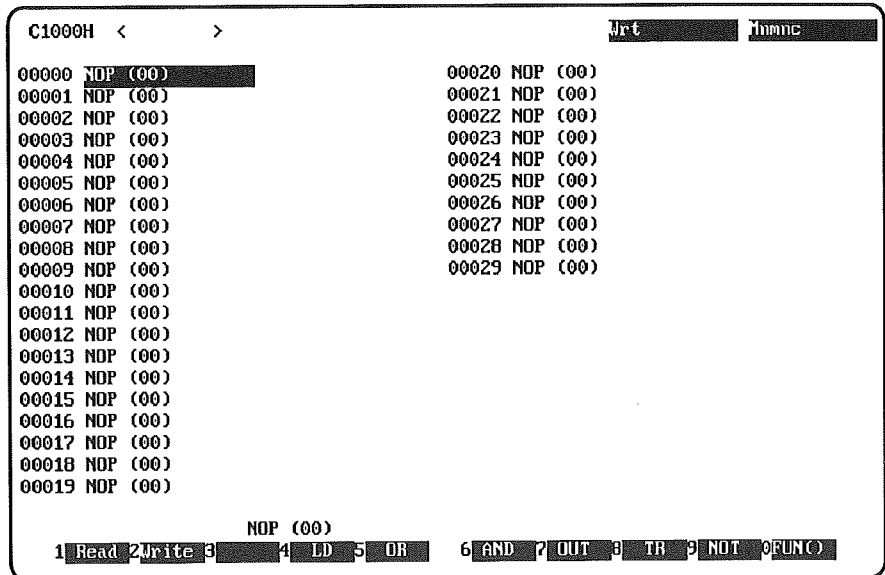

4. Move the cursor to the program address that is to be written.
5. Input the instruction using either function keys or by typing mnemonics, and then press Enter. (For this example, press the F4 Key followed by "1" and Enter.)
6. The instruction that was input will be written at the cursor position, and the cursor will move to the next position. No more than 40 lines can be written on a screen. If an attempt is made to exceed 40 lines, a message will be displayed and the extra lines cannot be written. If this occurs, either display the next program address to be written at the beginning of the display, or delete unused NOP instructions.
7. After the program has been input on one screen, press the PgDn Key to scroll to the next screen and continue writing the program from the next program address onwards.

## 2-8-5 Editing Mnemonic Programs

There are basically three ways to edit a mnemonic program:

- |                           |             |
|---------------------------|-------------|
| 1) Changing instructions  | Write mode  |
| 2) Inserting instructions | Insert mode |
| 3) Deleting instructions  | Delete mode |

It is not necessary to store a program after it is edited in the mnemonic display mode. The edited program will be automatically stored in the system work area. Always use the "P:Check program" operation to check for incorrect programs.

The following program editing operations can be carried out with ladder programming as well.

- 1) Adding or deleting NOT instructions.
- 2) Changing data areas.
- 3) Changing bit addresses.

### Procedure

#### 1, 2, 3...

1. Select "H:Change display" from the Programming Menu.
2. Select either "N:Mnemonic (F keys)" or "A:Mnemonic (typed)" from the "H:Change display" menu. The one that is selected will be displayed in the upper right part of the screen.
3. To change instructions, press the F2 Key to go into the Write mode. To insert instructions, press Shift+F1 to go into the Insert mode. To delete instructions, press Shift+F2 to go into the Delete mode. The mode will be displayed in the upper right part of the screen.
4. Move the cursor to the position of the instruction that is to be edited.
5. If changing or inserting an instruction, press the function key for the new instruction or input the instruction using the typed mnemonics, and then press Enter. If deleting an instruction, just press Enter while in Delete mode.  
The instruction that has been input or changed will be written at the cursor position, and the cursor will move to the next position.
6. After the program has been edited on one screen, press the PgDn Key to scroll to the next screen and continue editing the program from the next program address onwards.

### Inserting and Deleting Instructions

When an instruction is input, the previously existing instructions in the program will be moved down and the cursor will move to the original position.

It is possible to insert up to 10 lines in a screen at one time. To insert the 11th line onwards, first press the PgDn Key to scroll to the next screen.

Nothing but a NOP instruction can be inserted as the last instruction in the user program.

When using function key inputs, move the cursor to the instruction column to insert or delete an instruction. Instructions cannot be inserted or deleted when the cursor is at an operand.

There may be instructions in a block program that cannot be used. For details, refer to the programming manuals for the C1000H/C2000H.

## 2-8-6 Searching and Reading Mnemonic Programs

Specified contents of a mnemonic program in the system work area can be found and displayed on the screen. The procedure is the same whether function keys or typed mnemonics are used. Searching and reading can only be carried out in the Read mode. The following items can be found and displayed on the screen:

- Program addresses
- Basic instructions
- Bit addresses
- Instructions with function codes
- Instructions with specific operands

When a specified instruction is found, up to 30 lines can be displayed on the screen. Use the PgUp and PgDn Keys to scroll to the screens before and after the instruction that is found. To return to the last screen that was found, press the Tab Key.

When there is an END instruction in a program that is searched, the search will stop when the END instruction is reached. If the search is continued past the END instruction, a "Need an END" message will be displayed in the upper left corner of the screen.

When the search is completed, one of the following messages will be displayed.

| Message             | Search type                       | Method for continuing search  |
|---------------------|-----------------------------------|---|
| Last screen         | Search other than from main menu. | To search again for the same item, press Enter. The search will begin from program address 00000.<br>To search for a different item, repeat the procedure from the beginning. |
| No such instruction | Search from main menu.            | To search again for the same item, repeat the procedure from the beginning.   |

The search operation can be aborted at any time by pressing the Escape Key.

### Reading/Searching Mnemonic Programs

The following table summarizes the methods for reading and searching mnemonic programs.

| Operation                           | Key sequence   | Description   |
|-------------------------------------|--|---|
| Reading a specified program address | <i>Address</i> Enter   | It is not necessary to input leading zeros, e.g., input address 00000 as 0.   |
| Finding a basic instruction         | <b>F4 to F7 (F9)</b> <i>Bit_address</i> Enter<br>or<br>Press <b>F4</b> or <b>F7</b> , followed by <b>F8</b> Enter. | To input a TIM/CNT number, press Control+F6 or Control+F5 in place of the bit address. It is not necessary to input leading zeros for bit addresses.<br><br>To execute SET or RSET, press Shift+F8 or Shift+F9 and input the bit address. SET and RSET are valid only when the PC model is set to CQM1. |
| Searching for bits                  | <b>Ctrl+F9</b> <i>Bit_address</i> Enter  | Searches for all instructions using a specified bit address.<br><br>It is not necessary to input leading zeros.<br><br>While the search is in progress, "00000" is displayed at the bottom of the screen.   |

| Operation                                     | Key sequence   | Description  |
|---|--|--|
| Finding an instruction from its function code | <p>Instructions executed every cycle:<br/> <b>F10 Function_code (operand) Enter</b></p> <p>Differentiate instructions (with @)<br/> <b>F10 Function_code (@, F9, or /) (Operands) Enter</b></p> <p>Block program instructions (with &lt; &gt;)<br/> <b>Shift+F10 Function_code (Operands) (F9) Enter</b></p>         | <p>Input leading zeros of the function code.</p> <p>For block program instructions and function codes 4 to 15, 91, 92, 94, and 97, input the operand before pressing Enter.</p> <p>While the prompt FUN(??) or FUN&lt;??&gt; is displayed, press Enter or the Control+F Keys to display a table of instructions.</p> <p>Select the required instruction with the cursor and press Enter. The selected instruction will be displayed at the bottom of the screen.</p> <p>Press Enter to start the search.</p>   |
| Finding instructions containing operands      | <p>Input steps 1 through 7 in order.</p> <p>(1) <b>End</b></p> <p>(2) <b>K</b> The Search Menu will be displayed.</p> <p>(3) <b>N Enter</b></p> <p>(4) <i>Function_code</i> <b>Enter</b></p> <p>(5) <i>Operand</i> <b>Enter</b></p> <p>(6) <i>Beginning_program_address</i> <b>Enter</b></p> <p>(7) <b>Enter</b></p> | <p>Input leading zeros of the function code.</p> <p>Either one or several operands can be specified.</p> <p>Execute step 5 at left with the cursor at the position of the operand that is to be specified.</p> <p>Input Control+F9 for instructions using bit addresses as operands, and Control+F7 for instructions using word addresses as operands.</p> <p>For block program instructions, instructions without operands, and function codes 4 to 15, 91, 92, 94, and 97, use the method explained above for "finding an instruction from its function code."</p> |

**Finding Block Comments**

The procedure for searching for block comments in a mnemonic program is basically the same as for a ladder program. One difference is that in a mnemonic program the search can be continued from program address 00000 simply by pressing Enter.

1, 2, 3...

1. Select "H:Change display" from the Programming Menu.
2. Select either "N:Mnemonic (F keys)" or "A:Mnemonic (typed)" from the "H:Change display" menu. The one that is selected will be displayed in the upper right part of the screen. The operation outlined below is the same for both function key or typing mnemonics.
3. If not already in Read mode, press the F1 Key to go into Read mode. "Read" will then be displayed in the upper right part of the screen.
4. Input the contents of the search, using either function keys or typed mnemonics, and then press Enter. The search will begin from program address 00000. A message will flash while the search is in progress. When the object of the search is found, 30 lines of the program will be displayed beginning with that instruction.
5. To continue searching the program for the same contents, press Enter. If the same contents are found again, they will be displayed. When the end of the program is reached, a message will be displayed indicating that that is the last screen.



## SECTION 3

### Editing DM

This section explains the various commands on the DM Menu. These operations are used to enter data to the DM Area as 4-digit hexadecimal or ASCII, to save and retrieve the contents of the DM Area to and from a data disk or hard disk, print DM contents, or initialize all DM and EM data in the system work area.

|       |  |     |
|-------|--|-----|
| 3-1   | Editing DM . . . . .                                   | 112 |
| 3-2   | Changing the Input Mode (HEX ↔ ASCII) . . . . .        | 114 |
| 3-3   | Writing and Editing DM Data . . . . .                  | 114 |
| 3-4   | Reading DM Data . . . . .                              | 115 |
| 3-5   | Copying DM Data . . . . .                              | 116 |
| 3-6   | Filling DM Words with Same Value . . . . .             | 116 |
| 3-7   | Printing DM Data . . . . .                             | 117 |
| 3-8   | Saving DM Data . . . . .                               | 117 |
| 3-8-1 | Saving All DM Data (Save program) . . . . .            | 117 |
| 3-8-2 | Saving a Range of DM Data (Save block) . . . . .       | 118 |
| 3-9   | Retrieving DM Data . . . . .                           | 119 |
| 3-9-1 | Retrieving All DM Data (Retrieve) . . . . .            | 119 |
| 3-9-2 | Retrieving a Range of DM Data (Add retrieve) . . . . . | 120 |
| 3-10  | Initializing DM Data . . . . .                         | 123 |

### 3-1 Editing DM

The contents of DM held in the system work area can be edited directly using the DM display. With C200HS and C200HX/HG/HE PCs, the DM Menu can be used to edit the contents of DM 7000 through DM 9999. With C200HX/HG PCs, the DM Menu can be used to edit EM. (EM data is organized in banks of 6144 words.)

The DM display appears automatically when DM is selected from the main offline menu. This display shows the contents of the DM area in 160-word pages which can be written, copied, cleared, printed, etc. The main elements of the DM display are labelled in the following diagram.

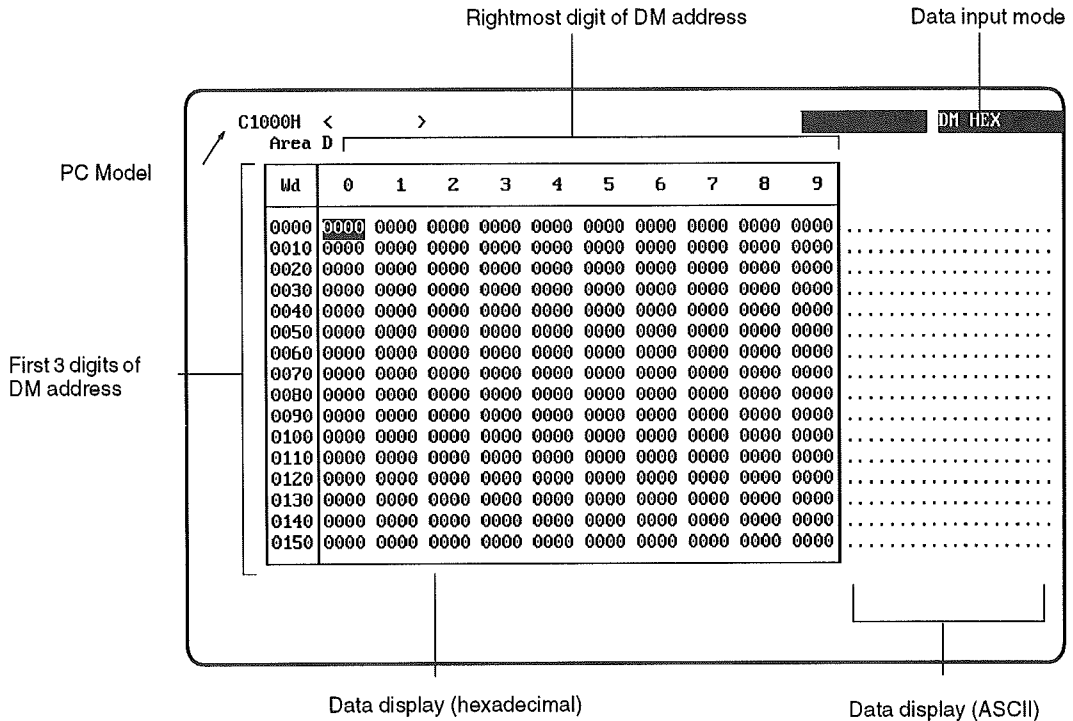

The DM display shows the contents in both hexadecimal and ASCII and the contents of the display can be input using either hexadecimal or ASCII. The PageUp, PageDown, and Cursor Keys can be used to move through the DM display.

- Note**
1. DM data is automatically stored in the system work area when input or edited. There is no need to perform a separate store operation.
  2. With CQM1, C200HS, and C200HX/HG/HE PCs, the PC Setup (in the Utility Menu) can also be used to edit the PC Setup, clear the PC Setup to default values, or transfer the PC Setup to and from data disk files.



DM Menu

Press the End Key to display the DM Menu, shown below.

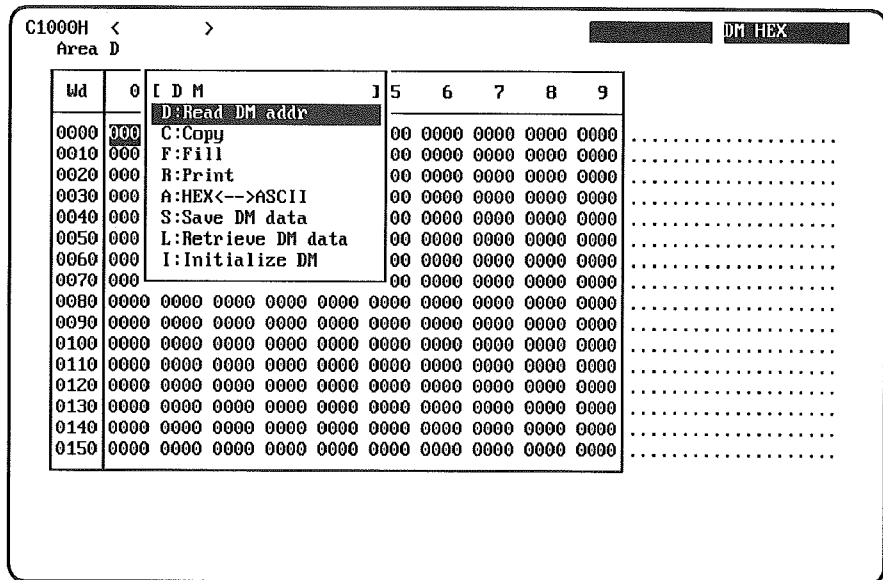

The following table lists the 8 operations that can be selected from the DM Menu. Select an operation by pressing its corresponding letter or moving the cursor to the operation and pressing Enter. These operations are described briefly in the following table and in more detail in later sections.

| Operation            | Function   |
|----------------------|--|
| D:Read DM address    | Displays the specified 160-word page of data that contains the specified DM or EM address.   |
| C:Copy               | Copies a specified number of consecutive DM or EM words beginning at the specified address.  |
| F:Fill               | Places a specified value into a specified number of consecutive DM or EM words beginning at a specified address.<br>A range of words can be cleared by filling them with 0000. |
| P:Print              | Prints the specified block of DM or EM words.  |
| A:HEX ↔ ASCII        | Sets input to hexadecimal or ASCII. The selected input mode will be displayed in the top-right of the screen.  |
| S:Save DM data       | Saves DM or EM data from the system work area to the data disk. All of the data can be saved or just a specified range.  |
| L:Retrieve DM data   | Retrieves DM or EM data from the data disk to the system work area. All of the data can be retrieved or just a specified range.  |
| I:Initialize DM data | Initializes all DM and EM data in the system work area to 0000.  |

DM Capacity

The amount of DM depends upon the model of PC being used, as shown in the following table. In the C200HS and C200HX/HG/HE PCs, part of the UM area can be allocated for use as expansion DM (DM 7000 through DM 9999).

| PC model                               | DM capacity |
|--|-------------|
| C2000H, CQM1, C200HS, and C200HX/HG/HE | 6,656 words |
| C1000H                                 | 4,096 words |
| C200H and Mini H-type PCs              | 2,000 words |
| C500, C120, and C50                    | 512 words   |
| C20                                    | None        |
| C20P, C28P, C40P, and C60P             | 64 words    |

In the C200HS and C200HX/HG/HE PCs, an additional 1,000 to 3,000 words of the UM area can be allocated for use as DM.

| Expansion DM allocation | Additional DM capacity |
|-------------------------|------------------------|
| DM 7000 through DM 7999 | 1,000 words            |
| DM 7000 through DM 8999 | 2,000 words            |
| DM 7000 through DM 9999 | 3,000 words            |

**EM Capacity** The C200HX and C200HG PCs are equipped with EM. The EM capacity depends on the model of CPU being used; refer to the *C200HX/HG/HE Programmable Controllers Operation Manual* for details.

| PC model     | EM area                                     | EM capacity                          |
|--------------|---|--------------------------------------|
| C200HX       | EM 0000 through EM 6143 (banks 0, 1, and 2) | 18,432 words (6,144 words × 3 banks) |
| C200HG       | EM 0000 through EM 6143 (bank 0 only)       | 6,144 words                          |
| Other models | None  | 0                                    |

### 3-2 Changing the Input Mode (HEX ↔ ASCII)

This command is used to switch between hexadecimal and ASCII data input when working with DM area contents. The current data input mode is indicated in the upper right-hand corner of the DM display.

Select "A:HEX ↔ ASCII" from the DM Menu. The message ASCII will be displayed in the input mode display. Each time this command is selected, ASCII and hexadecimal operation will be toggled.

Hexadecimal data is input using four hexadecimal digits; ASCII data is input using two ASCII characters. The following table shows the ASCII equivalent of each combination of hexadecimal digits.

| Right digit | Left digit |   |   |   |   |   |              |
|-------------|------------|---|---|---|---|---|--------------|
|             | 2          | 3 | 4 | 5 | 6 | 7 | 0, 1, 8 to F |
| 0           | Space      | 0 | @ | P | ' | p | Not used.    |
| 1           | !          | 1 | A | Q | a | q |              |
| 2           | "          | 2 | B | R | b | r |              |
| 3           | #          | 3 | C | S | c | s |              |
| 4           | \$         | 4 | D | T | d | t |              |
| 5           | %          | 5 | E | U | e | u |              |
| 6           | &          | 6 | F | V | f | v |              |
| 7           | '          | 7 | G | W | g | w |              |
| 8           | (          | 8 | H | X | h | x |              |
| 9           | )          | 9 | I | Y | i | y |              |
| A           | *          | : | J | Z | j | z |              |
| B           | +          | ; | K | [ | k | { |              |
| C           | ,          | < | L | \ | l |   |              |
| D           | -          | = | M | ] | m | } |              |
| E           | .          | > | N | ^ | n | ~ |              |
| F           | /          | ? | O | _ | o |   |              |

### 3-3 Writing and Editing DM Data

Follow the procedure below to change DM data in the system work area. (Data is written to the system work area automatically. It isn't necessary to perform the Store operation.)

The default input mode is hexadecimal. You can switch to ASCII mode by selecting "A:HEX ↔ ASCII" from the DM Menu. In both modes, use PageUp and PageDown to

go to the preceding or following page and use the cursor to go to specific words for writing and editing data.

- 1, 2, 3... 1. Select DM from the top-level offline menu. The DM display will appear.

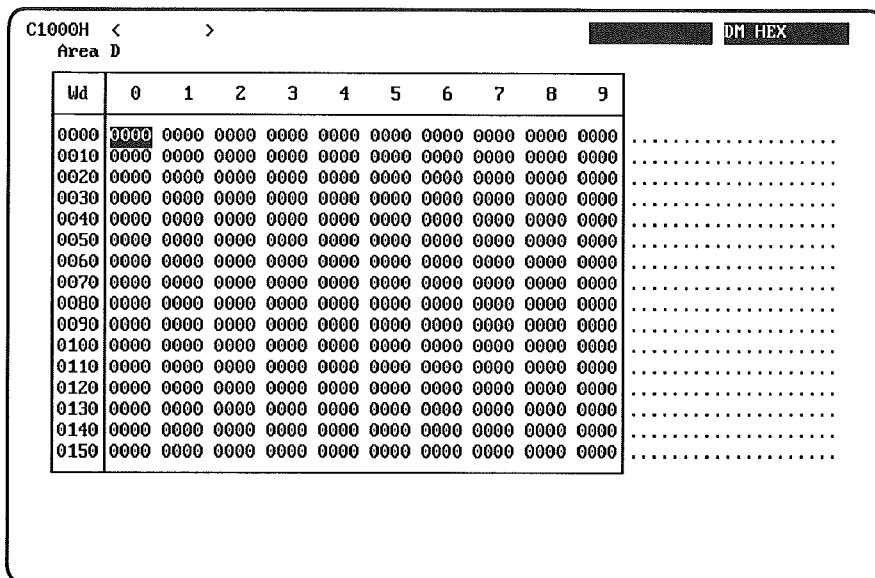

2. Use the Arrow Keys to move the cursor to the desired DM word.  
 It may be faster to press the End Key to display the DM Menu, select "D:Read DM address", and enter the desired DM or EM address.
3. Input the data and press Enter. The data will be displayed in the selected word and the corresponding ASCII code will be simultaneously displayed in the ASCII display at the right of the screen.

If a mistake is made while inputting, clear the input display by pressing Escape.  
 To change existing data, move the cursor to the desired word address, re-input and press Enter.

### 3-4 Reading DM Data

This command displays a DM display beginning with the specified DM or EM address.

- 1, 2, 3... 1. Press End to access the DM Menu.  
 2. Select "D:Read DM address" from the DM Menu.  
 3. Input the desired DM or EM address and press Enter. The DM display beginning with the specified address will appear.

**DM Addresses** To input a DM address, press the Control + F4 Keys and then enter the desired address.

**EM Addresses** To input an EM address, specify the EM Area by pressing the Shift + Control + F4 Keys. A particular EM bank can be specified by pressing the Shift + Control + F3 Keys and then the EM bank number.

Input the desired EM address after specifying the EM area and EM bank.

**Note** Just press the Shift + Control + F4 Keys and enter the desired EM address if it isn't necessary to specify an EM bank.

The following diagram shows the Function Key assignments after the Shift + Control Keys have been pressed. The same key sequence is used to input EM addresses for other commands.

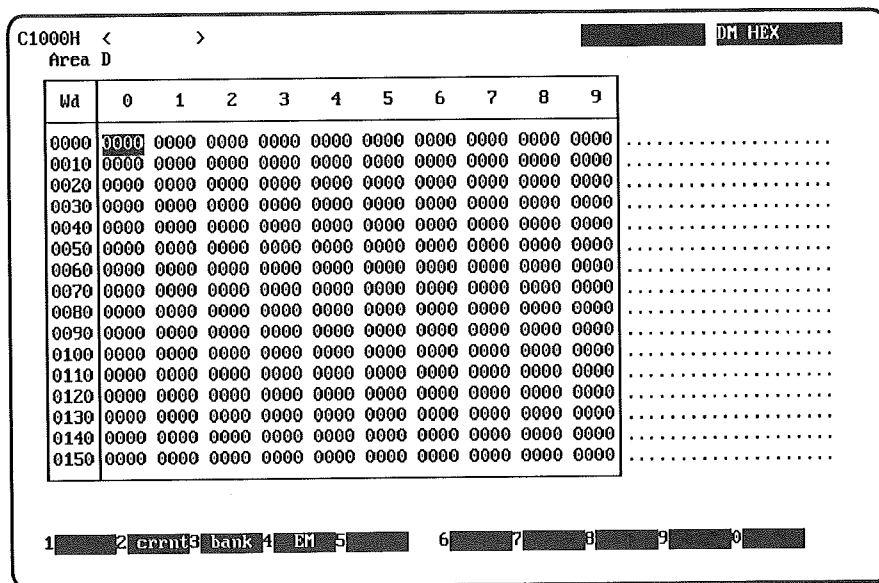

### 3-5 Copying DM Data

This command copies data from and to specified words. Refer to 3-4 Reading DM Data for details on inputting EM addresses.

- 1, 2, 3...
1. Press End to access the DM Menu.
  2. Select "C:Copy" from the DM Menu.
  3. Input the source starting word address from which data is to be copied and press Enter.
  4. Input the number of words to be copied and press Enter.
  5. Input the destination starting word address to which the specified data will be copied and press Enter. The contents of the specified source words will be copied to the destination words.

With the C200HS and C200HX/HG/HE PCs, make sure that the specified range of source words and destination words don't exceed the DM or EM area.

| Area             | Maximum address  | Applicable PCs          |
|------------------|--|-------------------------|
| Normal DM        | DM 6655  | C200HS and C200HX/HG/HE |
| Expansion DM*    | DM 7999, DM 8999, or DM 9999<br>(Expansion DM can be allocated 1K words, 2K words, or 3K words.) | C200HS and C200HX/HG/HE |
| EM bank 0        | EM 6143  | C200HX/HG               |
| EM banks 1 and 2 | EM 6143  | C200HX                  |

### 3-6 Filling DM Words with Same Value

This command writes the same data to a specified range of DM words.

- 1, 2, 3...
1. Press End to access the DM Menu.
  2. Select "F:Fill" from the DM Menu.
  3. Input the desired starting and end words, input the desired contents, and press Enter. Refer to 3-4 Reading DM Data for details on inputting EM addresses.

The default word range is DM 0000 to the highest DM address for the PC specified in the System Setup and the default data is 0000, so all DM data can be cleared by selecting "F:Fill" and pressing Enter 3 times. To clear only part of DM, specify the desired beginning and end addresses and use "0000" as the fill data.

Make sure that the specified range of words doesn't exceed the DM or EM area. The following table shows the maximum addresses for the C200HS and C200HX/HG/HE.

| Area             | Maximum address   | Applicable PCs          |
|------------------|---|-------------------------|
| Normal DM        | DM 6655   | C200HS and C200HX/HG/HE |
| Expansion DM*    | DM 7999, DM 8999, or DM 9999<br>(Expansion DM can be allocated<br>1K words, 2K words, or 3K words.) | C200HS and C200HX/HG/HE |
| EM bank 0        | EM 6143   | C200HX/HG               |
| EM banks 1 and 2 | EM 6143   | C200HX                  |

## 3-7 Printing DM Data

This command prints the contents of a specified range of DM or EM words. Refer to *3-4 Reading DM Data* for details on inputting EM addresses.

Refer to System Setup for details on specifying the printer model.

- 1, 2, 3...
1. Verify that the computer is connected to a printer and the printer is on-line.
  2. Press End to access the DM Menu.
  3. Select "P:Print" from the DM Menu.
  4. Enter the word range to be printed, and press Enter. The message "Printing" will be displayed until the entire specified word range has been printed.

**Note** The default word range is DM 0000 to the highest DM address for the PC specified in the System Setup, so all DM data can be printed by selecting "P:Print" and pressing Enter twice.

Press Escape to interrupt printing.

If this command is executed without a printer connected, the message "Printing" will flash until Escape is pressed.

## 3-8 Saving DM Data

These commands can be used to save all DM and EM data from the system work area to a data disk or just a specified range of words.

### 3-8-1 Saving All DM Data (Save program)

This command saves all DM and EM data from the system work area to a data disk. The data is saved as a DOS file with filename extension ".SP6". We recommend saving the DM data on the same disk as the ladder program.

DM data can't be saved in the LSS file format with the Save program command. To save data in the LSS format, use the Save block command; refer to *3-8-2 Saving a Range of DM Data (Save block)* for details.

**Note** This command saves DM and EM data only, and does not save the user program.

**Procedure** The procedure is as follows:

- 1, 2, 3...
1. Press End to display the DM Menu.

2. Select "S:Save DM data."

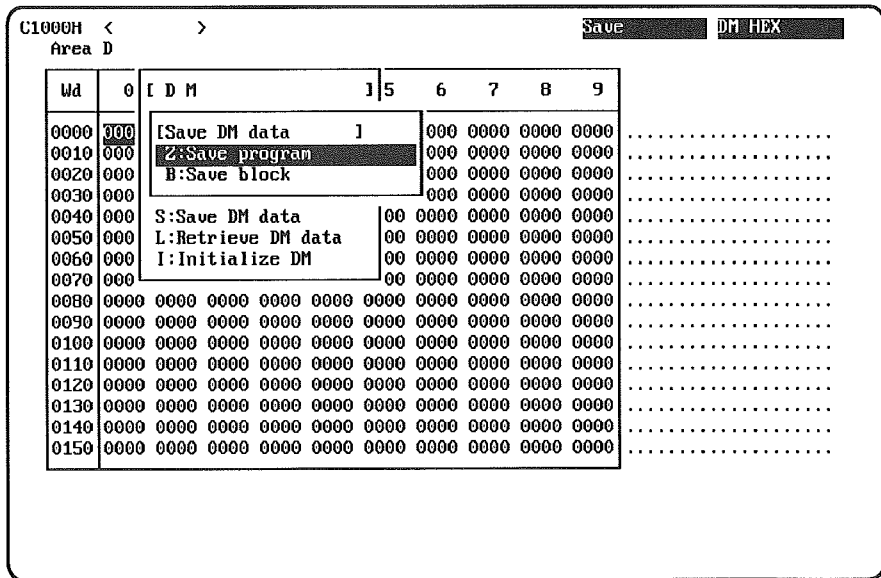

3. Select "Z:Save program."

4. A file name input area will be displayed and up to eight characters can be input as a file name. If the data disk's file name capacity is exceeded or if the data disk is invalid for a PC group, the corresponding error messages will be displayed.

If End is pressed while inputting a file name, the DM's directory of files will be displayed. From this directory, the desired file can be selected by moving the cursor and pressing Enter. Press Enter again to save the data under that file name.

5. If the specified file name already exists on the floppy disk, the message "There Is a file by that name, replace old file? Confirm (Y/N)?" will be displayed. Press Y and Enter to replace.

6. The data will be saved to the disk when the Enter Key is pressed and the DM display will return when the data has been saved.

### 3-8-2 Saving a Range of DM Data (Save block)

This command saves the specified range of data from the system work area to a data disk. Data can be saved in DOS files or in LSS files unless the PC model is set to C200HX/HG/HE; data must be saved in DOS files with the C200HX/HG/HE PCs.

A filename extension of ".SL4" is used for the DOS files and a filename extension of ".D" is used for the LSS files.

The data disk format (C2000H, C500, or C2000H/C500) must agree with the PC model set in the System Setup in order to save LSS files. An error will occur and the data won't be saved if the disk format doesn't agree with the PC model.

Make sure that the specified range of words doesn't exceed the DM or EM area. The following table shows the maximum addresses for the C200HS and C200HX/HG/HE.

| Area             | Maximum address  | Applicable PCs          |
|------------------|--|-------------------------|
| Normal DM        | DM 6655  | C200HS and C200HX/HG/HE |
| Expansion DM*    | DM 7999, DM 8999, or DM 9999<br>(Expansion DM can be allocated 1K words, 2K words, or 3K words.) | C200HS and C200HX/HG/HE |
| EM bank 0        | EM 6143  | C200HX/HG               |
| EM banks 1 and 2 | EM 6143  | C200HX                  |

**Procedure** The procedure is as follows:

- 1, 2, 3... 1. Press End to display the DM Menu.
2. Select "S:Save DM data."

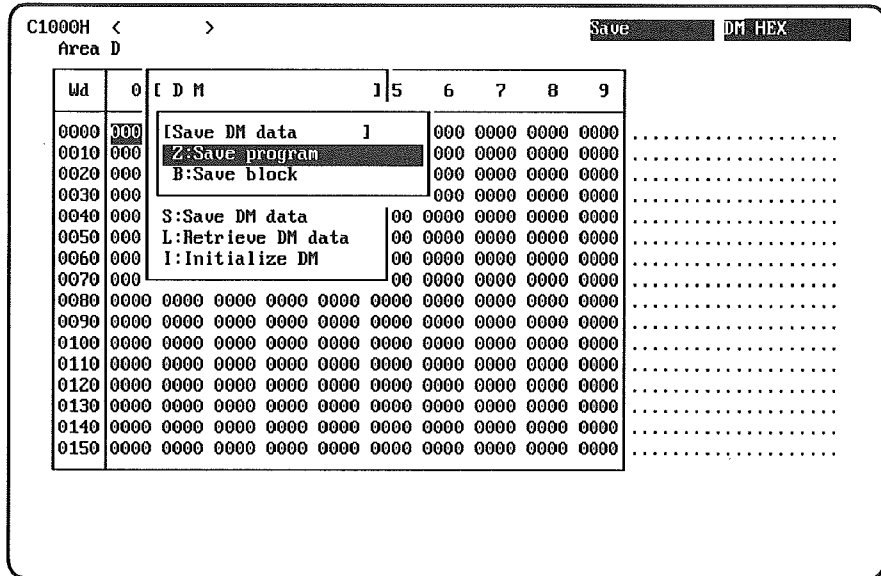

3. Select "B:Save block."
4. Enter the word range to be saved and press Enter. (Refer to 3-4 Reading DM Data for details on inputting EM addresses.)
5. A file name input area will be displayed and up to eight characters can be input as a file name. If the data disk's file name capacity is exceeded or if the data disk is invalid for a PC group, the corresponding error messages will be displayed. If End is pressed while inputting a file name, the DM's directory of files will be displayed. From this directory, the desired file can be selected by moving the cursor and pressing Enter. Press Enter again to save the data under that file name.
6. If the specified file name already exists on the floppy disk, the message "There is a file by that name, replace old file? Confirm (Y/N)?" will be displayed. Press Y and Enter to replace.
7. The data will be saved to the disk when the Enter Key is pressed and the DM display will return when the data has been saved.

**Note** The default word range is DM 0000 to the highest DM address for the PC specified in the System Setup, so all DM data can be saved by selecting "S:Save DM data" and pressing Enter twice.

## 3-9 Retrieving DM Data

These commands retrieve DM and EM data from a data disk to the system work area.

### 3-9-1 Retrieving All DM Data (Retrieve)

This command retrieves all DM data from the data disk and writes it to the system work area. Files saved with the Save program command (files with the .SP6 filename extension or files in LSS format) can be retrieved with this command.

Files saved with the Save block command (files with the .SL4 filename extension) can't be retrieved with the Retrieve command. Use the Add retrieve command to retrieve this data. Refer to 3-9-2 Retrieving a Range of DM Data (Add retrieve) for details.

The range of DM data that can be retrieved depends upon the PC model set in the System Setup.

Each file saved with the Save program command (files with the .SP6 filename extension) belongs to one of the following 4 categories based on the PC model:

C500, C120, C50, C20, and C□□P  
 C2000H, C1000H, C200H, C□□H, and CQM1  
 C200HS  
 C200HX, C200HG, and C200HE

An error will occur and the data won't be retrieved if the file was saved in a category that doesn't agree with the PC model set in the System Setup.

#### Procedure

The procedure is as follows:

- 1, 2, 3... 1. Insert the data disk containing the desired file into the floppy disk drive.
2. Press End to access the DM Menu.
3. Select "L:Retrieve DM data."

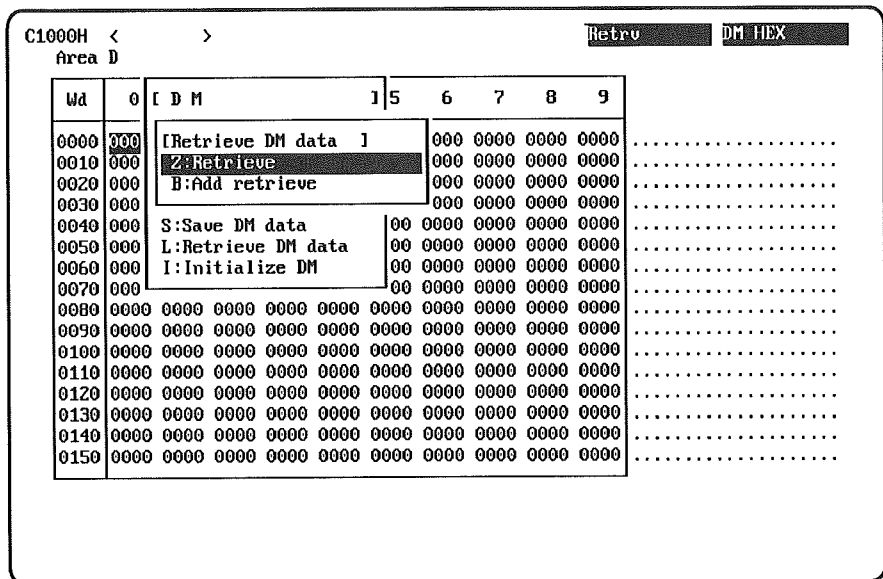

4. Select "Z:Retrieve." A file name input area will be displayed.
5. Input the desired file name and press Enter. When the operation is complete, the basic display will return.

If End is pressed while inputting a file name, the DM's directory of files will be displayed. From this directory, the desired file can be selected by using the cursor and then pressing Enter. Press Enter again to retrieve the data under that file name.

Press Escape to interrupt the process and to return to the DM Menu. Press Escape to return to the basic display.

### 3-9-2 Retrieving a Range of DM Data (Add retrieve)

This command retrieves data from the data disk beginning at the specified DM or EM address and writes it to the system work area. Data can be retrieved for any PC model regardless of the PC model used when the data was saved with the Save block command.

DM data can be retrieved only from files saved with the Save block command with the .SL4 filename extension; data cannot be retrieved from files saved with the Save program command (files with the .SP6 filename extension) or files in LSS format.



If the data on the disk exceeds the maximum DM or EM address for the PC model, the data will be read up to the maximum address and a message indicating "No room in DM" will be displayed. The following table shows the maximum addresses for the C200HS and C200HX/HG/HE.

| Area             | Maximum address   | Applicable PCs          |
|------------------|---|-------------------------|
| Normal DM        | DM 6655   | C200HS and C200HX/HG/HE |
| Expansion DM*    | DM 7999, DM 8999, or DM 9999<br>(Expansion DM can be allocated<br>1K words, 2K words, or 3K words.) | C200HS and C200HX/HG/HE |
| EM bank 0        | EM 6143   | C200HX/HG               |
| EM banks 1 and 2 | EM 6143   | C200HX                  |

**Procedure**

The procedure is as follows:

1, 2, 3...

1. Insert the data disk containing the desired file into the floppy disk drive.
2. Press End to access the DM Menu.
3. Select "L:Retrieve DM data."

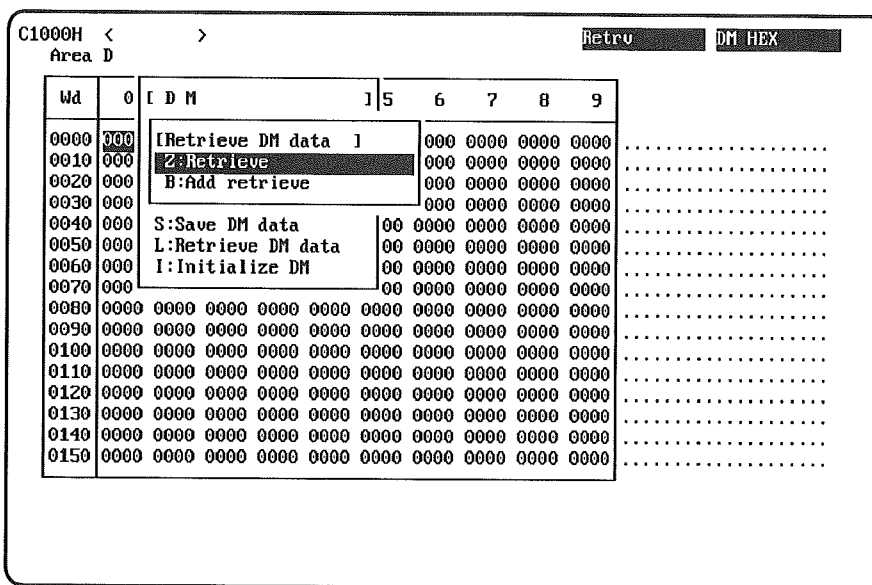

4. Select "B:Add retrieve." A file name input area will be displayed.
5. Input the desired file name, and press Enter. The starting address input area will be displayed.

If End is pressed while inputting a file name, a directory of files will be displayed. From this directory, the desired file can be selected by using the cursor and then pressing Enter.

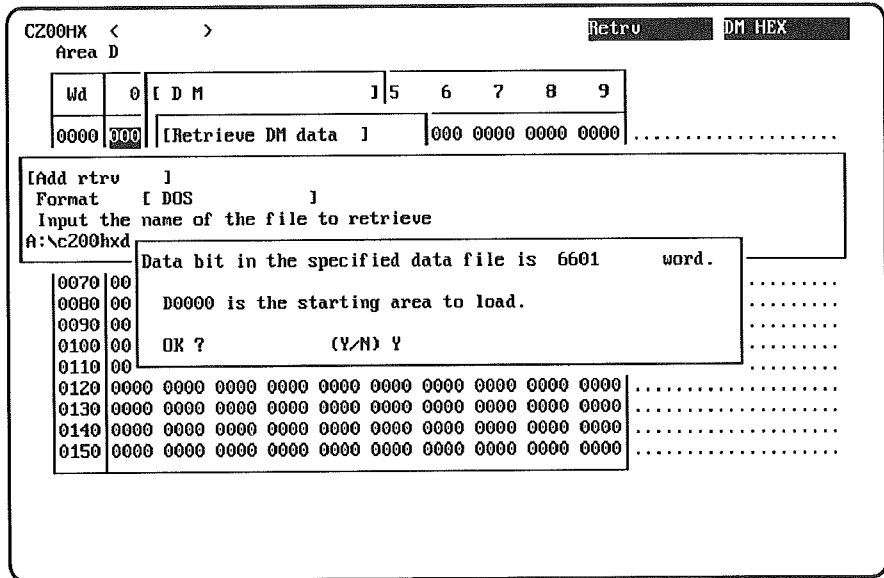

6. The default starting address is DM 0000. Press the Enter Key to accept DM 0000 as the starting address.

To input a different DM or EM address, press N and Enter and then input the desired starting address. Refer to 3-4 Reading DM Data for details on inputting EM addresses.

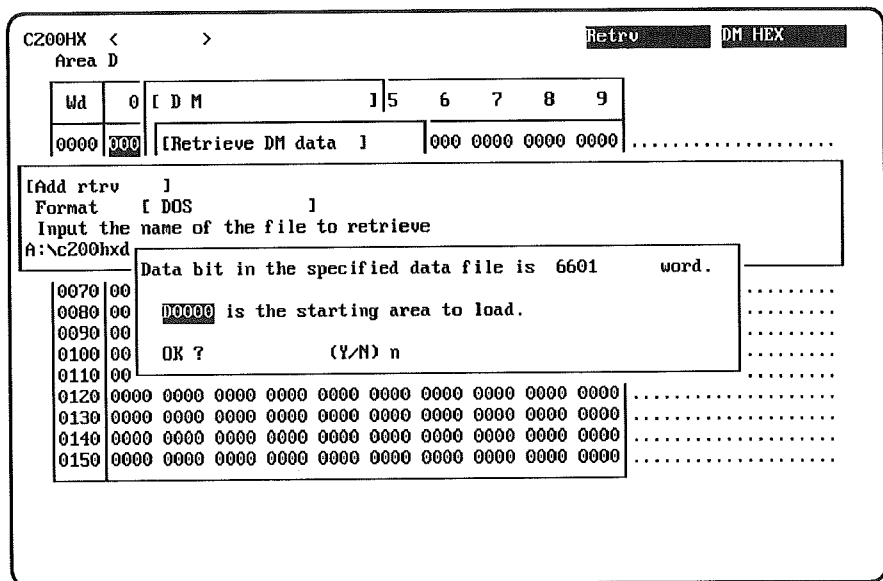

### 3-10 Initializing DM Data

This command initializes all DM and EM data in the system work area to 0000.

- 1, 2, 3...
1. Press End to display the DM Menu.
  2. Select "I:Initialize DM." A confirmation prompt will appear.

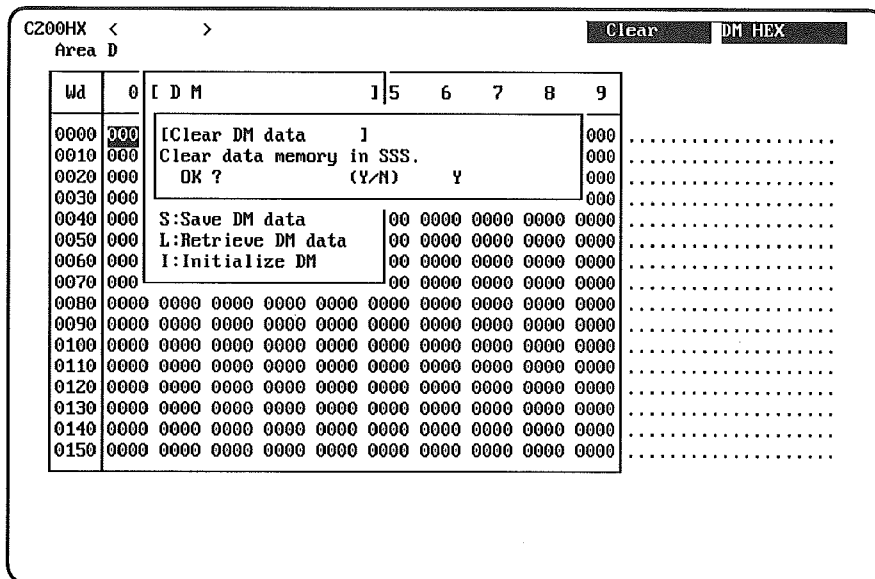

3. Press Enter to initialize the DM and EM data. Press N and Enter to cancel the operation.



## SECTION 4

### Editing I/O Tables

This section explains the various commands on the I/O Table Menu. These operations can be used to create and edit the I/O table at the computer and store it in the system work area, to check that the I/O table is correct, to save and retrieve the contents of the I/O table to and from a data disk or hard disk, and to print the contents of the I/O table.

I/O tables are not required by the C20, P-type, K-type, or CQM1 PCs.

|       |  |     |
|-------|--|-----|
| 4-1   | Editing I/O Tables .....               | 126 |
| 4-2   | I/O Table Errors .....                 | 128 |
| 4-3   | Display Formats .....                  | 129 |
| 4-3-1 | Function Keys .....                    | 130 |
| 4-4   | Writing I/O Tables .....               | 131 |
| 4-4-1 | Slave Racks .....                      | 131 |
| 4-4-2 | Optical I/O Units .....                | 133 |
| 4-4-3 | Group-2 Multipoint I/O Units .....     | 135 |
| 4-5   | Checking I/O Tables .....              | 137 |
| 4-6   | Saving/Retrieving I/O Tables .....     | 138 |
| 4-6-1 | Saving I/O Tables .....                | 138 |
| 4-6-2 | Retrieving I/O Table .....             | 139 |
| 4-7   | Printing I/O Tables .....              | 139 |
| 4-8   | Allocations to Special I/O Units ..... | 140 |

## 4-1 Editing I/O Tables

I/O tables list the various Units and their mounting status in a PC, including I/O, Special I/O, Remote I/O, and other Units. The I/O table is used so that the CPU can recognize the different Units it can use to perform control operations.

An I/O table can be automatically generated online according to the Units actually mounted/connected to the PC. The offline I/O tables editing operations can be used to make adjustments in the I/O table when necessary, e.g., when a Unit is not available or when the PC has not actually been set up yet.

**Caution** When you have finished inputting an I/O table, press F10, Y, and Enter. Without this operation, the I/O table will not be saved in the system work area.

An I/O table input offline can also be transferred to a PC using online operations, but only when only basic Racks are used and only for the C1000H and C2000H. Transfer is not possible for other PCs or when remote I/O is used.

To print I/O designations on ladder diagrams, the I/O table must be manually input offline or automatically generated online before printing the ladder diagrams.

### Deleting I/O Table Data

To delete data written into the I/O table, move the cursor to the data to be deleted and press Home, Enter.

### Initial Display

The I/O table display will appear when "I/O table" is selected from the top-level offline menu. The rack number indicated by the cursor on the left side of the screen indicates the number of the rack which is currently being displayed.

PC model specified in System Setup

C1000H < > Read I/O table

|          | 0                     | 1    | 2    | 3    | 4    | 5    | 6    | 7    | (Unit) |
|----------|-----------------------|------|------|------|------|------|------|------|--------|
| Rack0    | c000                  |      |      | c018 |      |      | c019 | c020 | (Wd)   |
| Rack1    | II**                  | RM0  | RM1  | O*** | **** | RM2  | O*** | I*** |        |
| Rack2    | Master rack RM 0 RT 0 |      |      |      |      |      |      |      |        |
| Rack3    | 0                     | 1    | 2    | 3    | 4    | 5    | 6    | 7    | (Unit) |
| Rack4    | c002                  | c003 | c004 | c006 | c010 | c014 |      |      | (Wd)   |
| Rack5    | I***                  | **** | O*** | II** | IIII | 0000 | I*** | **** |        |
| Rack6    | Master rack RM 0 RT 1 |      |      |      |      |      |      |      |        |
| Rack7    | 0                     | 1    | 2    | 3    | 4    | 5    | 6    | 7    | (Unit) |
|          | c015                  | c017 |      |      |      |      |      |      | (Wd)   |
| BOpt I/O | 00**                  | I*** | **** | **** | **** | **** | **** | **** |        |

RM??-Rem Mast  
 ↳BP No.  
 ↳Rem No.  
 INT?-INT unit  
 ↳INT No.  
 I: Input  
 O: Output  
 N: Reserved  
 \*: None

1 2 3 Rack 4 5 6 7 8 9 0

You can press the F3 key to enter the number of the rack you want to display or use the PageUp and PageDown keys to scroll up and down through the rack numbers (including Slave Racks).

If there are 2 or more Masters on a rack or if 3 or more Slave Racks are connected to a single Master for the C1000H/C2000H, the PageUp and PageDown keys will show the I/O table settings for those Slaves before continuing to the next Expansion I/O Rack.

**I/O Table Menu** Once the I/O table display is on screen, the I/O Table Menu can be displayed by pressing the End Key.

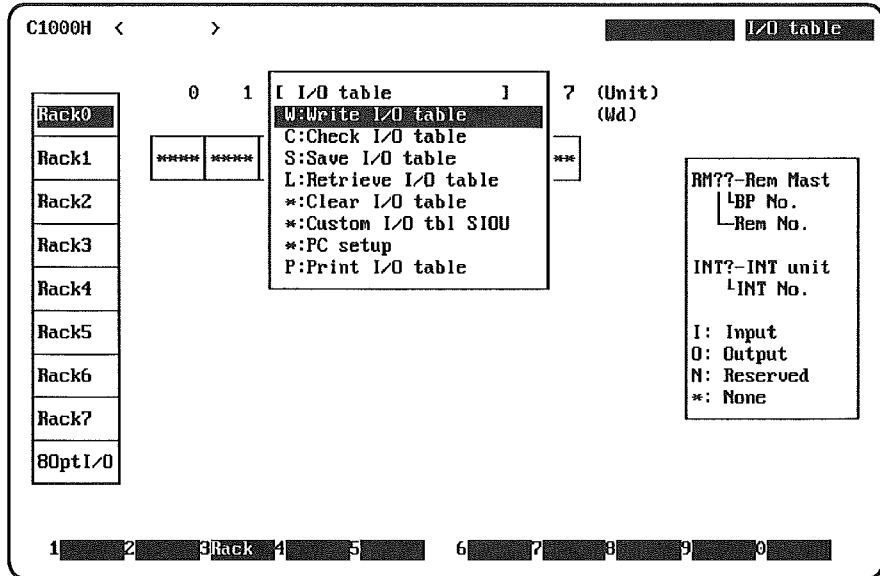

The following table lists the 5 operations that can be selected from the I/O Table Menu. Select an operation by pressing its corresponding letter or moving the cursor to the operation and pressing Enter. These operations are described briefly in the following table and in more detail in later sections.

| Operation             | Function  |
|-----------------------|---|
| W: Write I/O table    | Used to write and edit the I/O table in the system work area.                                 |
| C: Check I/O table    | Checks the contents of the I/O table in the system work area and displays errors if detected. |
| S: Save I/O table     | Saves the I/O table contents in the system work area to the data disk.                        |
| L: Retrieve I/O table | Retrieves the I/O table contents from the data disk to the system work area.                  |
| P: Print I/O table    | Prints the contents of the I/O table in the system work area.                                 |

## 4-2 I/O Table Errors

The contents of the I/O table are checked when the I/O table is written to the system work area or the "C:Check I/O table" command is executed. Any I/O errors detected in the checks will be listed on the screen. The errors are grouped according to racks in the following order:

- 1, 2, 3...
1. CPU/Expansion I/O Racks (base Racks)
  2. Slave Racks
  3. Optical I/O Units

Use the PageUp and PageDown keys to scroll up and down through the list of errors. Press Escape to exit the list and return to the I/O table display. Be sure to correct any errors detected during the I/O table check.

The following I/O table errors can occur in any PC:

| Error message               | Error description  | Remedy   |
|-----------------------------|--|--|
| Word over                   | The total number of words exceeds the limit.   | Change settings to bring the total number of words below the limit.                |
| Undefined Rem               | Master not recognized by the CPU because of transmission error, etc.<br>(Detected by "Check I/O table" only.)            | Check the CPU.   |
| Slave rack over             | The total number of Slaves exceeds the prescribed limit.   | Refer to page 141 for details.   |
| Duplicated word (not C200H) | Words allocated to an Optical I/O Unit are the same as those allocated to an Expansion I/O Rack or Unit on a Slave Rack. | Change settings so that the same word is not allocated twice.                      |
| IN/OUT mix (not C200H)      | Both inputs and outputs used in the same word of a I/O Terminal.   | Change the settings so that only inputs or only outputs are used in a single word. |

The following I/O table errors can occur in C200H PCs:

| Error message         | Error description   | Remedy   |
|-----------------------|---|--|
| Special I/O No. dupl  | Duplicate unit numbers for Special I/O Units.<br>(Detected by "Check I/O table" only.)                | Change settings so that the same unit number is not used twice.  |
| Special I/O No. error | A unit number for a Special I/O Unit is not between 0 and 9.<br>(Detected by "Check I/O table" only.) | Change settings so that the unit number is 9 or lower.   |
| RM No. duplicated     | Duplicate unit numbers for Master Units.<br>(Detected by "Check I/O table" only.)                     | Up to 2 Masters can be mounted to a PC. If there are 2 Masters, one must be set to 0 and the other to 1. |
| RM unit No. error     | A unit number for a Master Unit is not 0 or 1.<br>(Detected by "Check I/O table" only.)               | Change settings so that the unit number is 0 or 1.   |
| RM set error          | A Master Unit is mounted on a Slave Rack.<br>(Detected by "Check I/O table" only.)                    | A Master cannot be mounted on a Slave Rack.  |
| RT Word over          | More than 20 words are allocated to Units on a C500 Slave Rack.                                       | Bring the total number of words below 20.  |
| RT unit duplicated    | Duplicate unit numbers for Slaves connected to a Master Unit.   | Change the unit number settings on the Slaves to eliminate duplication.                                  |
| Optical I/O Wd dupl   | The same words are allocated to more than one Optical I/O Unit connected to a Master Unit.            | Change settings so that the same word is not allocated twice.  |



### 4-3 Display Formats

The I/O table display for the C200H/C200HS is different from other PCs. The C200H/C200HS PCs have fewer Racks and different function keys.

**General Display**

With C-series PCs other than the C200H, C200HS, and C200HX/C200HG/C200HE, the following display will appear when you select "W:Write I/O table" and press Enter.

Wrt I/O table

C1000H < >

| Bsc Rck | 0    | 1    | 2    | 3    | 4    | 5    | 6    | 7 (Unit) |
|---------|------|------|------|------|------|------|------|----------|
| Rack0   | II** | RM0  | RM1  | O*** | **** | **** | **** | I***     |
| Rack1   | **** | **** | **** | **** | **** | **** | **** | ****     |
| Rack2   | **** | **** | **** | **** | **** | **** | **** | ****     |
| Rack3   | **** | **** | **** | **** | **** | **** | **** | ****     |
| Rack4   | **** | **** | **** | **** | **** | **** | **** | ****     |
| Rack5   | **** | **** | **** | **** | **** | **** | **** | ****     |
| Rack6   | **** | **** | **** | **** | **** | **** | **** | ****     |
| Rack7   | **** | **** | **** | **** | **** | **** | **** | ****     |

RM??-Rem Mast  
└─BP No.  
└─Rem No.

INT?-INT unit  
└─INT No.

I: Input  
O: Output  
N: Reserved  
\*: None

1 OUT
2 IN
3 INT IN
4 RM
5 Wd res
6 RT
7 Optic
8
9
0 Exit

- Note**
1. The "INT IN" for the F3 key is displayed with C1000H/C2000H, C200HS, and C200HX/C200HG/C200HE PCs only.
  2. The "Wd res" for the F5 key is displayed with C1000H/C2000H PCs only.

**C200H/HS Display**

With the C200H, C200HS and C200HX/C200HG/C200HE, the following display will appear when you select "W:Write I/O table" and press Enter.

Wrt I/O table

C200HS < >

| Bsc Rck | 0    | 1  | 2    | 3    | 4   | 5  | 6  | 7   | 8    | 9 (Unit) |
|---------|------|----|------|------|-----|----|----|-----|------|----------|
| Rack0   | 0000 | ii | II** | 0000 | 0NM | 2C | 4A | RM0 | INT0 | **       |
| Rack1   | **   | ** | **   | **   | **  | ** | ** | **  | **   | **       |
| Rack2   | **   | ** | **   | **   | **  | ** | ** | **  | **   | **       |
| Rack3   | **   | ** | **   | **   | **  | ** | ** | **  | **   | **       |

RM?-Rem Mast  
└─Rem No.

???-Spec I/O  
└─Units  
└─-1unit  
└─W-2unit  
└─Type of I/O  
C: Counter  
N: Pos Con  
A: Other  
???: Undef  
└─Unit No.  
i,o: 8 points  
I,O: 16 points  
---RT model err

1 OUT
2 IN
3 INT IN
4 RM
5 32/64
6 RT
7 Optic
8 Spec
9 Word
0 Exit

The following table indicates the Units that correspond to the codes for Rack 1, shown above. The display codes are explained in more detail in 4-3-1 Function Keys.

| Slot | Display | Meaning  |
|------|---------|--|
| 0    | OOOO    | 64-point Output Unit (Group-2 Multipoint I/O Unit) |
| 1    | ii      | 16-point Input Unit                                |
| 2    | II**    | 32-point Input Unit (Group-2 Multipoint I/O Unit)  |
| 3    | OOOO    | 64-point Output Unit (Group-2 Multipoint I/O Unit) |
| 4    | 0NW     | Position Control Unit, Special I/O Unit #0         |
| 5    | 2C      | Counter Unit, Special I/O Unit #2                  |
| 6    | 4A      | Special I/O Unit #4                                |
| 7    | RM0     | Remote I/O Master #0                               |
| 8    | INT0    | Interrupt Input Unit #0                            |
| 9    | ****    | No Unit recorded                                   |

### 4-3-1 Function Keys

The following table shows the functions performed by the function keys and the Home Key.

| Key | Display           | Function   |
|-----|-------------------|--|
| F1  | O                 | Specifies Output Units.<br>An "O" indicates a 16-point Output Unit. (Except C200H, C200HS, C200HX/C200HG/C200HE, and Optical I/O Units)<br>C200H/C200HS: An "o" indicates an 8-point Output Unit.<br>Optical I/O Units: An "O" indicates 8 output points.  |
| F2  | I                 | Specifies Input Units.<br>An "I" indicates a 16-point Input Unit. (Except C200H, C200HS, C200HX/C200HG/C200HE, and Optical I/O Units)<br>C200H/C200HS: An "i" indicates an 8-point Input Unit.<br>Optical I/O Units: An "I" indicates 8 input points.  |
| F3  | INT               | Specifies Interrupt Input Units. (C1000H, C2000H, C200HS, and C200HX/C200HG/C200HE only)<br>C1000H/C2000H: Up to 4 Interrupt Input Units may be specified on Rack 0 only.<br>C200HS: Only 1 Interrupt Input Unit may be specified on Rack 0.<br>C200HX/C200HG/C200HE: Up to 2 Interrupt Input Units may be specified on Rack 0 only  |
| F4  | RM                | Specifies Remote I/O Master Units.<br>PCs other than C200H/C200HS/C200HX/C200HG/C200HE:<br>Unit numbers for Master Units are allocated automatically from left to right.<br>Word multipliers for Optical I/O Units (C1000H and C2000H only) are also allocated automatically.<br>C200H/C200HS/C200HX/C200HG/C200HE: Input the Master Unit unit numbers (0 or 1).   |
| F5  | N                 | Reserves words. (C1000H and C2000H only)<br>Each "N" indicates 16 I/O points reserved by Dummy I/O Units.  |
|     | I, O              | Specifies a Group-2 Multipoint I/O Unit. (C200H/C200HS/C200HX/C200HG/C200HE only)  |
| F6  | RT                | When the cursor is over a slot allocated to a Master (RM), this key specifies a Slave Rack. An input display will appear for the Slave Rack when F6 is pressed.  |
| F7  | ---               | When the cursor is over a slot allocated to a Master Master (RM), this key specifies an Optical I/O Unit or I/O Link Unit. An input display for Optical I/O Units will appear when F6 is pressed.  |
| F8  | 0 to 9<br>C, N, A | Specifies a Special I/O Unit. (C200H/C200HS only)<br>Press F8 to display letters (C, N, and A) which indicate the type of Special I/O Unit.<br>Input a "C" to indicate a High-speed Counter, an "N" to indicate a Position Control Unit, or an "A" to indicate another Unit. Input the unit number (C200H/C200HS: 0 to 9; C200HX/C200HG/C200HE: 0 to F) next to the letter.<br>A prompt will appear for the number of I/O words when the unit number is input. Input the required number of words.<br>Special I/O Units cannot be used to print X/Y I/O. |

| Key  | Display | Function   |
|------|---------|--|
| F9   | W       | Specifies a second Special I/O Unit unit number. (C200H-NC211 only)<br>Press F9 to allocate a second unit number for the C200H-NC211. Finish inputting the data for the first unit number and then return to the slot and press F9 to input a second unit number.  |
| F10  | ---     | Exits the Write I/O table operation.<br>When this key is pressed, the I/O table is checked. If no errors are detected, the I/O table will be written to the system work area.<br><br>If errors are detected, they will be displayed. Press Escape to return to the editing mode, correct the I/O table, and press F10 again to recheck the I/O table and write it to the system work area. |
| Home | ****    | Clears the slot at the cursor position.<br>To cancel a slot assigned on the I/O table, press Home with the cursor at the position of the Unit. **** will be displayed indicating that nothing has been assigned.   |

## 4-4 Writing I/O Tables

The Write I/O table operation is used to edit the I/O table stored in the system work area. Select Write I/O table from the I/O Table Menu and press Enter.

This command can be used to input the I/O table, but the online Create I/O Table command is preferable if the Units are mounted to the PC because it writes the I/O table automatically. Refer to 12-2-1 *Creating I/O Tables* for details.

 **Caution** If you use Escape to leave the displays for inputting I/O tables, the data that has been input will not be saved. To save your work, press F10 and Enter after inputting data on any particular display

**Procedure** The general procedure for writing the I/O table is as follows.

- 1, 2, 3...
1. Select "W:Write I/O table" from the I/O Table Menu and press Enter.
  2. Use the function keys to write the I/O table data and press Enter.
  3. When you are finished with the I/O table, press F10 to exit. A prompt will appear to confirm that you want to exit. Press Enter to exit or "N" and Enter to cancel.  
If you were editing I/O table entries for a Slave Rack or Optical I/O Unit, the basic I/O table display will be appear when you exit. Press F10 again to exit the I/O table display.
  4. An I/O table check is performed automatically when you exit. Any errors that are detected will be displayed. If no errors are found, the I/O table will be saved to the system work area automatically.

**Note** The I/O table won't be saved to the system work area unless you exit the I/O table display by pressing F10.

### 4-4-1 Slave Racks

This section provides examples of writing I/O tables for Slave Racks. The procedure for C200H/C200HS/C200HX/C200HG/C200HE Slave Racks is slightly different from the procedure for other Slave Racks.

**General Case** Follow this procedure when writing I/O tables for Slave Racks connected to C-series PCs other than the C200H, C200HS, and C200HX/C200HG/C200HE.

- 1, 2, 3...
1. Select "W:Write I/O table" from the I/O Table Menu and press Enter.

2. Move the cursor to the Master (RM) where the Slave Rack (RT) will be connected and press the F6 key. The I/O table for the Slave Racks will be displayed. (If you have not assigned a Master to a slot, move the cursor to the proper slot on the base Racks and press F4, Enter.)

With C1000H/C2000H PCs, you can display up to 8 Racks by pressing the F5 Key. Two Racks will be added each time F5 is pressed.

C1000H < > Jrt I/O table

| RMO rack | 0    | 1    | 2    | 3    | 4    | 5    | 6    | 7 (Unit) |
|----------|------|------|------|------|------|------|------|----------|
| RT-0     | II** | I*** | O*** | O*** | **** | **** | **** | ****     |
| RT-1     | **** | **** | **** | **** | **** | **** | **** | ****     |

I: Input  
O: Output  
N: Reserved  
\*: None

1 OUT 2 IN 3 Md res 4 Add RT 5 Del RT 6 7 8 9 0 Exit

3. Use function keys F1 through F3 to write the I/O table data and press Enter. You can delete Slave Racks by pressing F6.

Refer to 4-8 Allocations to Special I/O Units for details on the number of Units that can be connected to a PC or Slave Rack.

4. When you are finished with the I/O table, press F10 to exit the Slave Rack display. Press F10 again to exit the I/O table display.

An I/O table check is performed automatically when you exit. Any errors that are detected will be displayed. If no errors are found, the I/O table will be saved to the system work area automatically.

**C200H/C200HS/ C200HX/ C200HG/ C200HE** Follow this procedure when writing I/O tables for Slave Racks connected to C200H, C200HS, and C200HX/C200HG/C200HE PCs.

- 1, 2, 3... 1. Select "W:Write I/O table" from the I/O Table Menu and press Enter.
2. Move the cursor to the Master (RM) where the Slave Rack (RT) will be connected and press the F6 key. The I/O table for the Slave Racks will be displayed. (If you have not assigned a Master to a slot, move the cursor to the proper slot on the base Racks and press F4, input the Master's unit number, and press Enter.)

C200HS < > Rt I/O table

| RM0 rack | 0 | 1 | 2 | 3 | 4 | 5 | 6 | 7 | 8 | 9 (Unit) |
|----------|---|---|---|---|---|---|---|---|---|----------|
| RT-0     |   |   |   |   |   |   |   |   |   |          |
| RT-1     |   |   |   |   |   |   |   |   |   |          |
| RT-2     |   |   |   |   |   |   |   |   |   |          |
| RT-3     |   |   |   |   |   |   |   |   |   |          |
| RT-4     |   |   |   |   |   |   |   |   |   |          |
| RT-5     |   |   |   |   |   |   |   |   |   |          |
| RT-6     |   |   |   |   |   |   |   |   |   |          |
| RT-7     |   |   |   |   |   |   |   |   |   |          |

RM?--Rem Mast  
Rem No.

???--Spec I/O  
Units  
-1unit  
W-2unit  
Type of I/O  
C: Counter  
N: Pos Con  
A: Other  
A?: Undef  
Unit No.  
i,o: 8 points  
I,O: 16 points  
---RT model err

1 OUT
2 IN
3
4+10RTI
5+8RTI
6RTCncI
7
8 Spcl
9 Word
0 Exit

Function keys F4 to F6 have the following functions:

- F4: Specify a C200H/C200HS/C200HX/C200HG/C200HE Slave Rack
- F5: Specify a C500 Slave Rack
- F6: Delete a Slave Rack

3. Press F4 to input data for a C200H/C200HS Slave Rack, F5 for a C500 Slave Rack. A C500 Slave Rack occupies the space of 2 C200H Slave Racks.
4. Use function keys F1, F2, F8, and F9 to write the I/O table data and press Enter. F8 and F9 can only be used for C200H/C200HS Slave Racks and F9 can only be used for a slot to which a Special I/O Unit has already been allocated. You can delete the Slave Rack where the cursor is located by pressing F6. Unit numbers 0 to 7 and Slave Rack numbers 0 to 4 can be used.

Refer to 4-8 *Allocations to Special I/O Units* for details on the number of Units that can be connected to a PC or Slave Rack.

5. When you are finished with the I/O table, press F10 to exit the Slave Rack display. Press F10 and Enter to exit the I/O table display.

An I/O table check is performed automatically when you exit. Any errors that are detected will be displayed. If no errors are found, the I/O table will be saved to the system work area automatically.

### 4-4-2 Optical I/O Units

This section provides examples of writing I/O tables for Optical I/O Units. The procedure for C200H/C200HS/C200HX/C200HG/C200HE Optical I/O Units is slightly different from the procedure for other Optical I/O Units.

**General Case** Follow this procedure when writing I/O tables for Optical I/O Units connected to C-series PCs other than the C200H, C200HS, and C200HX/C200HG/C200HE.

- 1, 2, 3... 1. Select "W:Write I/O table" from the I/O Table Menu and press Enter.
2. Move the cursor to the Rack where the Master (RM) is mounted and press the F7 key. The I/O table for the Optical I/O Units connected to that Master will be dis-

played. (If you have not assigned a Master to a slot, move the cursor to the proper slot on the base Racks and press F4, Enter.)

| C1000H < > |      |      |      |      |      |      |      | Int                 | I/O table |
|------------|------|------|------|------|------|------|------|---------------------|-----------|
| L H        | L H  | L H  | L H  | L H  | L H  | L H  | L H  | (Low ,High<br>Word) |           |
| c000       | c001 | c002 | c003 | c004 | c005 | c006 | c007 |                     |           |
| **         | **   | **   | **   | **   | **   | **   | **   |                     |           |
| c008       | c009 | c010 | c011 | c012 | c013 | c014 | c015 |                     |           |
| **         | **   | **   | **   | **   | **   | **   | **   |                     |           |
| c016       | c017 | c018 | c019 | c020 | c021 | c022 | c023 |                     |           |
| **         | **   | **   | **   | **   | **   | **   | **   |                     |           |
| c024       | c025 | c026 | c027 | c028 | c029 | c030 | c031 |                     |           |
| **         | **   | **   | **   | **   | **   | **   | **   |                     |           |

I: Input  
O: Output  
W: Duplctd  
\*: None

1 OUT 2 IN 3 4 5 6 7 8 9 0 Exit

- Use function keys F1 and F2 to write the I/O table data and press Enter. Each "I" or "O" represents 8 I/O points. Do not combine 8 input points and 8 output points in a single word.

With C1000H/C2000H PCs, press the PageUp and PageDown keys to scroll between the 32-word groups defined by word multipliers (C000 to C031, C032 to C063, C064 to C095, and C096 to C127).

**Note** To avoid allocating a word twice, we recommend allocating I/O words from the last word down.

- When you are finished with the I/O table, press F10 to exit the Optical I/O Unit display. Press F10 and Enter to exit the I/O table display.

An I/O table check is performed automatically when you exit. Any errors that are detected will be displayed. If no errors are found, the I/O table will be saved to the system work area automatically.

When mounting the Optical I/O Units, set the I/O word allocated to each Unit on the Unit's DIP switch. With C1000H/C2000H Racks, be sure to add 32xthe word multiplier to the I/O word set on the DIP switch.

**C200H/C200HS/ C200HX/ C200HG/ C200HE** Follow this procedure when writing I/O tables for Optical I/O Units connected to C200H, C200HS and C200HX/C200HG/C200HE PCs.

- 1, 2, 3... 1. Select "W:Write I/O table" from the I/O Table Menu and press Enter.
2. Move the cursor to the Rack where the Master (RM) is mounted and press the F7 key. The I/O table for the Optical I/O Units connected to that Master will be displayed. (If you have not assigned a Master to a slot, move the cursor to the proper

slot on the base Racks and press F4, input the Master's unit number, and press Enter.)

| C200HS < > |      |      |      |      |      |      |      | Jrt                   | I/O table |
|------------|------|------|------|------|------|------|------|-----------------------|-----------|
| L H        | L H  | L H  | L H  | L H  | L H  | L H  | L H  | (Low ,High)<br>(Word) |           |
| c200       | c201 | c202 | c203 | c204 | c205 | c206 | c207 |                       |           |
| ** *       | ** * | ** * | ** * | ** * | ** * | ** * | ** * |                       |           |
| c208       | c209 | c210 | c211 | c212 | c213 | c214 | c215 |                       |           |
| ** *       | ** * | ** * | ** * | ** * | ** * | ** * | ** * |                       |           |
| c216       | c217 | c218 | c219 | c220 | c221 | c222 | c223 |                       |           |
| ** *       | ** * | ** * | ** * | ** * | ** * | ** * | ** * |                       |           |
| c224       | c225 | c226 | c227 | c228 | c229 | c230 | c231 |                       |           |
| ** *       | ** * | ** * | ** * | ** * | ** * | ** * | ** * |                       |           |

I: Input  
O: Output  
W: Duplctd  
\*: None

1 OUT 2 IN 3 4 5 6 7 8 9 0 Exit

3. Use function keys F1 and F2 to write the I/O table data and press Enter. Each "I" or "O" represents 8 I/O points. With the C200H/C200HS/C200HX/C200HG/C200HE 8 input points and 8 output points can be combined in a single word.

With C200H/C200HS/C200HX/C200HG/C200HE PCs, words IR 200 to IR 231 are allocated to Optical I/O Units, so the I/O words can be allocated from the PC.

4. When you are finished with the I/O table, press F10 to exit the Optical I/O Unit display. Press F10 and Enter to exit the I/O table display.

An I/O table check is performed automatically when you exit. Any errors that are detected will be displayed. If no errors are found, the I/O table will be saved to the system work area automatically.

When mounting the Optical I/O Units, set the lower 2 digits of the I/O word on the switch on the front of the Unit. (For example, set the Unit's switch to 15 if IR 215 is allocated to the Unit.)

### 4-4-3 Group-2 Multipoint I/O Units

The following procedure shows how to include C200H/C200HS/C200HX/C200HG/C200HE Multipoint I/O Units in an I/O table. Group-2 Multipoint I/O Units are compatible with C200H/C200HS/C200HX/C200HG/C200HE PCs only.

- 1, 2, 3... 1. Select "W:Write I/O table" from the I/O Table Menu and press Enter.





- When you are finished with the I/O table, press F10 and Enter to exit. The I/O table will be read and the following display will appear. (Press Escape to clear the menu.)

```

C200HS < > Read I/O table
  0 1 2 3 4 5 6 7 8 9 (Unit)
Rack0 c030 c001 c034 c036 c008 (Wd)
Rack1 0000 ii II** 0000 0NW ZC 4A RM0 INT0 **
Rack2 Master rack RM 0 RT 0
Rack3 0 1 2 3 4 5 6 7 8 9
4OptXmt *** **
Master rack RM 0 RT 1
0 1 2 3 4 5 6 7 8 9
*** **
1 2 3 Rack 4 5 6 7 8 9 0
  
```

RM?--Rem Mast  
Rem No.

???--Spec I/O  
Units  
-1unit  
W-2unit  
Type of I/O  
C: Counter  
N: Pos Con  
A: Other  
???: Undef  
Unit No.  
i,o: 8 points  
I,O: 16 points  
---RT model err

C200H/C200HS/C200HX/C200HG/C200HE Display

```

C200HS < > Wrt I/O table
Bsc Rck 0 1 2 3 4 5 6 7 8 9 (Unit)
Rack0 0000 ii II** 0000 0NW ZC 4A RM0 INT0 **
Rack1 *** **
Rack2 *** **
Rack3 *** **
1 OUT 2 IN 3 INT IN4 RM 5 32/64 6 RT 7 Optic 8 Spcl 9 Word 0 Exit
  
```

RM?--Rem Mast  
Rem No.

???--Spec I/O  
Units  
-1unit  
W-2unit  
Type of I/O  
C: Counter  
N: Pos Con  
A: Other  
???: Undef  
Unit No.  
i,o: 8 points  
I,O: 16 points  
---RT model err

**Note** In C200H PCs, "INT IN" will not be displayed next to F3 at the bottom of the screen.

## 4-5 Checking I/O Tables

The I/O table checking operation is used to check the I/O table stored in the system work area for errors in I/O assignments.

Press Escape to return to the I/O Table Menu.

- 1, 2, 3... 1. Select "C:Check I/O table" from the I/O Table Menu and press Enter. The contents of the I/O table will be checked.

If errors are detected, the corresponding error messages will be displayed. If too many errors have occurred to be displayed on one screen, use PageUp and PageDown to display them.

| C1000H <SAMPLE ><br>Optical I/O |      |     |                 | Check | I/O table |     |                 |
|---------------------------------|------|-----|-----------------|-------|-----------|-----|-----------------|
| Rem                             | Wd   | I/O | Error message   | Rem   | Wd        | I/O | Error message   |
| 0                               | 000L | 0   | Duplicated Word | 0     | 009L      | 0   | Duplicated Word |
| 0                               | 000H | 0   | Duplicated Word | 0     | 009H      | 0   | Duplicated Word |
| 0                               | 001L | 0   | Duplicated Word | 0     | 010L      | 0   | Duplicated Word |
| 0                               | 001H | 0   | Duplicated Word | 0     | 010H      | 0   | Duplicated Word |
| 0                               | 002L | 0   | Duplicated Word | 0     | 011L      | 0   | Duplicated Word |
| 0                               | 002H | 0   | Duplicated Word | 0     | 011H      | 0   | Duplicated Word |
| 0                               | 003L | 0   | Duplicated Word |       |           |     |                 |
| 0                               | 003H | 0   | Duplicated Word |       |           |     |                 |
| 0                               | 004L | 0   | Duplicated Word |       |           |     |                 |
| 0                               | 004H | 0   | Duplicated Word |       |           |     |                 |
| 0                               | 005L | 0   | Duplicated Word |       |           |     |                 |
| 0                               | 005H | 0   | Duplicated Word |       |           |     |                 |
| 0                               | 006L | 0   | Duplicated Word |       |           |     |                 |
| 0                               | 006H | 0   | Duplicated Word |       |           |     |                 |
| 0                               | 007L | 0   | Duplicated Word |       |           |     |                 |
| 0                               | 007H | 0   | Duplicated Word |       |           |     |                 |
| 0                               | 008L | 0   | Duplicated Word |       |           |     |                 |
| 0                               | 008H | 0   | Duplicated Word |       |           |     |                 |

Complete

2. If errors have been found correct them with the "C:Create I/O table" operation. Refer to 4-2 I/O Table Errors for details on errors and troubleshooting.
3. Press Escape to return to the I/O Table Menu.

## 4-6 Saving/Retrieving I/O Tables

The Save I/O Table and Retrieve I/O Table operations are used to transfer data between the system work area and data disks (floppy disks).

### 4-6-1 Saving I/O Tables

The Save I/O Table command is used to save I/O tables stored in the system work area to a data disk. The data can be saved as an MS-DOS file or in the LSS format. C200HX/C200HG/C200HE data cannot be saved in LSS format.

We recommend that you save the I/O table data on the same disk as the program. There are three types of LSS data disk: C2000H, C500, and C2000H/C500. The data disk type must match the PC model set in the System Setup. An error will occur and the I/O table won't be saved if the data disk does not match the PC model.

- 1, 2, 3...
1. If you are using floppy disks, insert an initialized data disk in the disk drive.

2. Select "S: Save I/O table" from the I/O Table Menu and press Enter.

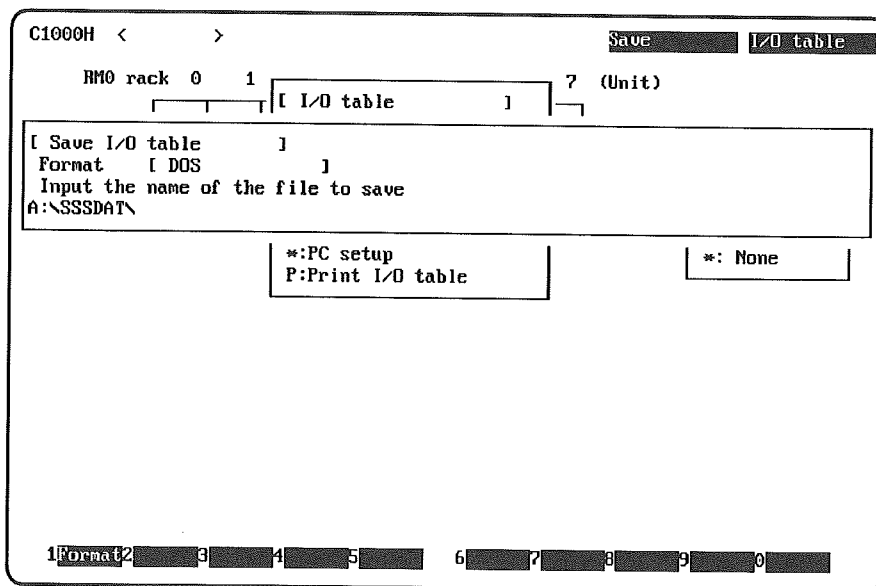

3. Input the desired file name and press Enter.

## 4-6-2 Retrieving I/O Table

The Retrieve I/O Table command is used to retrieve I/O tables from a data disk to the system work area.

- 1, 2, 3...
  1. If you are using floppy disks, insert the data disk that contains the desired file in the disk drive.
  2. Select "L:Retrieve I/O table" from the I/O Table Menu and press Enter.
  3. Press the End key to display the directory of files on the data disk. Move the cursor to the desired file name and press Enter.

The I/O Table Menu will be displayed when the file has been retrieved to the system work area.

## 4-7 Printing I/O Tables

The Print I/O Table operation prints out the I/O table stored in the system work area. Be sure the printer is connected and operable before trying to print I/O tables. If an attempt to print fails, press the Escape Key, check the printer and connections, and try again.

- 1, 2, 3...
  1. Check that the printer is connected and online.
  2. Select "P:Print I/O table" from the I/O Table Menu and press Enter.

Printing can be cancelled by pressing the Escape Key. Printing will continue, however, until the printer buffer empties.

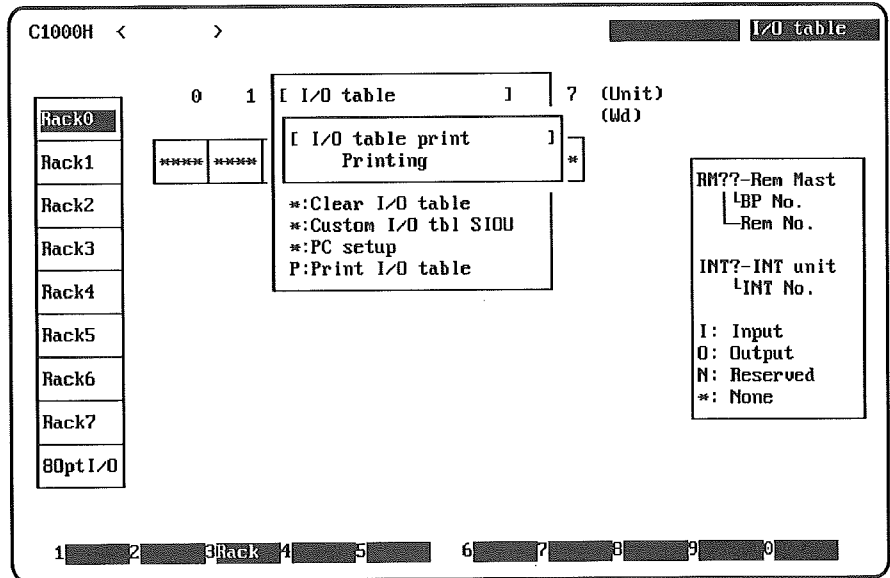

## 4-8 Allocations to Special I/O Units

**Display Codes** The following table shows the I/O table display code for Standard, Mixed, and Special I/O Units.

| Class                      | Name                            | Model number        | Display code |
|----------------------------|---------------------------------|---------------------|--------------|
| Standard I/O Units         | Input Unit                      | C500-ID212          |              |
|                            | Output Unit                     | C500-OD211          |              |
| Mixed I/O Units            | DC Input/Transistor Output Unit | C500-MD211CN        |              |
| Special I/O Units          | Analog Input Units              | C500-AD001 to AD005 |              |
|                            |                                 | C500-AD006/AD007    |              |
|                            |                                 | C500-AD101          | (Note 1)     |
|                            | Analog Output Units             | C500-DA001 to DA005 |              |
|                            |                                 | C500-DA101          |              |
|                            | High-speed Counter Units        | C500-CT001          |              |
|                            |                                 | C500-CT012          |              |
|                            | Magnetic Card Reader            | C500-MGC01/041/021  |              |
|                            | PID Unit                        | C500-PID01          | (Note 2)     |
|                            | Position Control Units          | C500-NC103          | (Note 2)     |
|                            |                                 | C500-NC111-V1/112   |              |
|                            |                                 | C500-NC121          | (Note 2)     |
|                            |                                 | C500-NC221          |              |
|                            | Cam Positioner Unit             | C500-CP131          | (Note 1)     |
|                            | Voice Unit                      | C500-OV001          |              |
| ASCII Unit                 | C500-ASC04                      | (Note 1)            |              |
| ID Sensor Unit             | C500-IDS01                      | (Note 1)            |              |
| Logic I/O Unit             | C500-LD211                      |                     |              |
| Ladder Program I/O Unit    | C500-LDP01-V1                   |                     |              |
| Assembler Program I/O Unit | C500-ASP01/02                   | (Note 1)            |              |

- Note** 1. Input a display code of “ ” when the Unit cannot use the Intelligent I/O Read/Write instructions (WRIT(87) and READ(88)).

The affected Units are: C500-AD101, CP131, ASC04, IDS01, and ASP01/02.

2. These Units (C500-PID01, NC103, and NC12) require 2 slots. When installing one of these Units, input the display code from the table above for the left slot and don't input anything for the right slot.

**I/O Words**

The following table shows the number of I/O words required by C200H/C200HS/C200HX/C200HG/C200HE Special I/O Units.

| Model number   |         | Input words | Output words |
|----------------|---------|-------------|--------------|
| C200H-CT001-V1 |         | 6           | 4            |
| C200H-CT002    |         | 6           | 4            |
| C200H-NC111    |         | 5           | 5            |
| C200H-NC112    |         | 5           | 5            |
| C200H-NC221    |         | 10          | 10           |
| C200H-ID501    | Static  | 2           | 0            |
| C200H-ID215    | Static  | 2           | 0            |
| C200H-OD501    | Static  | 0           | 2            |
|                | Dynamic | 0           | 8            |
| C200H-OD215    | Static  | 0           | 2            |
|                | Dynamic | 0           | 8            |
| C200H-MD501    | Static  | 1           | 1            |
|                | Dynamic | 8           | 0            |
| C200H-MD215    | Static  | 1           | 1            |
|                | Dynamic | 8           | 0            |
| C200H-AD001    |         | 5           | 1            |
| C200H-DA001    |         | 1           | 3            |
| C200H-TS001    |         | 5           | 1            |
| C200H-TS101    |         | 5           | 1            |
| C200H-ASC02    |         | 1           | 3            |

**Restrictions on Remote I/O**

The following table shows the restrictions on the number of Remote I/O Master Units that can be connected to a single PC and other restrictions on Remote I/O Systems.

| Item  | C120    | C500                 | C1000H<br>C2000H     | C200H<br>C200HS<br>C200HX<br>C200HG<br>C200HE |
|---|---------|----------------------|----------------------|---|
| Masters connected to 1 PC   | 4 max.  | 4 max.               | 8 max.               | 2 max.  |
| Slave Racks connected to 1 Master                                   | 2 max.  | 2 max.               | 8 max.               | 5 max.  |
| Slave Racks connected to 1 PC                                       | 8 max.  | 8 max.               | 16 max.              | 5 max.  |
| Slaves, I/O Link Units, and Optical I/O Units connected to 1 Master | 32 max. | 64 max. <sup>1</sup> | 64 max. <sup>1</sup> | 64 max. <sup>2</sup>                          |
| I/O words allocated to 1 Master                                     | 16 max. | 32 max.              | 32 max.              | 32 max. <sup>2</sup>                          |

- Note** 1. A B500-RPT01 Repeater Unit must be used when more than 32 Units are connected. The total number of I/O words cannot exceed 32.
2. A total of 64 Units and 32 I/O words max. for I/O Terminals and Optical I/O Units.



# SECTION 5

## Utility Operations

This section explains the various commands within the Utility Menu. The Utility Menu contains a variety of operations used to manage programming, debugging, and system data.

|        |  |     |
|--------|--|-----|
| 5-1    | The Utility Menu .....                           | 144 |
| 5-2    | Displaying Data Lists .....                      | 145 |
| 5-2-1  | Used Data Areas .....                            | 146 |
| 5-2-2  | Used Areas W/Cmnts .....                         | 147 |
| 5-2-3  | Unused Data Areas .....                          | 148 |
| 5-2-4  | Cross References .....                           | 149 |
| 5-3    | Globally Changing Addresses .....                | 149 |
| 5-3-1  | Changing Bit Addresses and TIM/CNT Numbers ..... | 150 |
| 5-3-2  | Changing Word Addresses .....                    | 152 |
| 5-3-3  | Changing Word and Bit Addresses .....            | 155 |
| 5-4    | Printing Lists .....                             | 157 |
| 5-4-1  | Used Data Areas .....                            | 158 |
| 5-4-2  | Unused Data Areas .....                          | 159 |
| 5-4-3  | Cross References .....                           | 160 |
| 5-4-4  | Ladder Diagrams .....                            | 161 |
| 5-4-5  | Ladder Diagrams & I/O .....                      | 163 |
| 5-4-6  | Printing Mnemonics .....                         | 163 |
| 5-5    | Manipulating EPROM .....                         | 164 |
| 5-5-1  | Chip Selection and Chip Number Assignments ..... | 165 |
| 5-5-2  | Writing to EPROM .....                           | 167 |
| 5-5-3  | Reading from EPROM .....                         | 169 |
| 5-5-4  | Verifying Programs on EPROM .....                | 171 |
| 5-5-5  | Intel HEX File .....                             | 173 |
| 5-6    | Converting Programs .....                        | 175 |
| 5-6-1  | C2000H → CVM1 .....                              | 175 |
| 5-6-2  | C500 → C2000H .....                              | 175 |
| 5-7    | Creating LSS Data Libraries .....                | 177 |
| 5-8    | Time Chart Monitor Data .....                    | 178 |
| 5-9    | Instruction Trace Data .....                     | 179 |
| 5-10   | Data Trace Data .....                            | 179 |
| 5-11   | Instructions Tables .....                        | 180 |
| 5-11-1 | Editing Instructions Tables .....                | 182 |
| 5-11-2 | Saving Instructions Tables .....                 | 183 |
| 5-11-3 | Retrieving Instructions Tables .....             | 184 |
| 5-12   | Expansion Instructions .....                     | 185 |
| 5-12-1 | Saving Expansion Instructions .....              | 186 |
| 5-12-2 | Retrieving Expansion Instructions .....          | 187 |
| 5-12-3 | Transferring Expansion Instructions .....        | 187 |
| 5-13   | PC Setup .....                                   | 187 |
| 5-13-1 | Setting the PC Setup .....                       | 188 |
| 5-13-2 | Saving PC Setup to Disk .....                    | 198 |
| 5-13-3 | Retrieving PC Setup from Disk .....              | 198 |
| 5-13-4 | Clearing the PC Setup .....                      | 198 |
| 5-13-5 | Transferring the PC Setup .....                  | 199 |
| 5-14   | Allocating UM .....                              | 199 |

## 5-1 The Utility Menu

The Utility Menu is displayed when "Utility" is selected from the top-level offline menu.

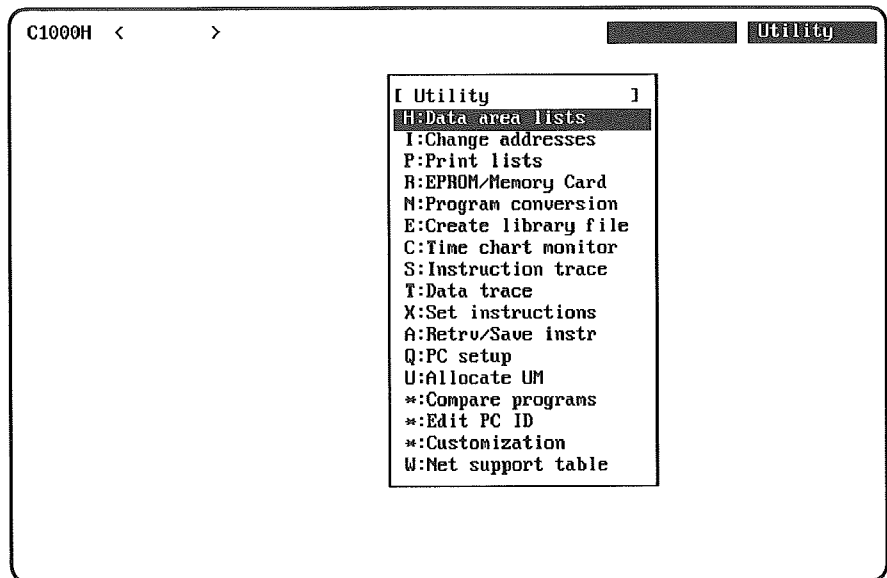

The following table lists the operations that can be selected from the Utility Menu. Select an operation by pressing its corresponding letter or moving the cursor to the operation and pressing Enter. These operations are described briefly in the following table and in more detail in later sections.

| Operation             | Function  |
|-----------------------|---|
| H:Data area lists     | Displays data area information (such as used areas and cross-references) for the program in the system work area.         |
| I:Change addresses    | Changes bit and word addresses in the program in the system work area.  |
| P:Print lists         | Prints lists of data and the program (ladder diagrams or mnemonics) using the program in the system work area.            |
| R:EPROM/Memory Card   | Writes, reads, and compares the program on EPROM.   |
| N:Program conversion  | Converts the program format (C500→C2000H).  |
| E:Create library file | Formats a floppy disk or hard disk so that it can be used as a data disk.   |
| C:Time chart monitor  | Accesses the time chart monitor displays that were produced online.   |
| S:Instruction trace   | Accesses the instruction trace displays that were produced online.  |
| T:Data trace          | Accesses the data trace displays that were produced online.   |
| X:Set instructions    | Assigns function codes to instructions. (C200HS and CQM1 only)  |
| A:Retrv/Save instr    | Transfers instruction tables to/from data disks. (C200HS and CQM1 only)   |
| Q:PC Setup            | Sets the PC Setup parameters used in the C200HS and CQM1.   |
| U:Allocate UM         | Allocates parts of UM as the Fixed DM Area and/or I/O Comment Area.   |
| W:Net support table   | Creates SYSMAC NET Link and SYSMAC LINK data link tables. Refer to <i>Part 4: Networks</i> for details on this operation. |



## 5-2 Displaying Data Lists

The four operations in Data Area Lists Menu display information on how the specified data area's words and bits are used in the program. These operations cannot be used to change word/bit usage. The following diagram shows the Data Area Lists Menu, which is displayed when "H:Data area lists" is selected from the Utility Menu.

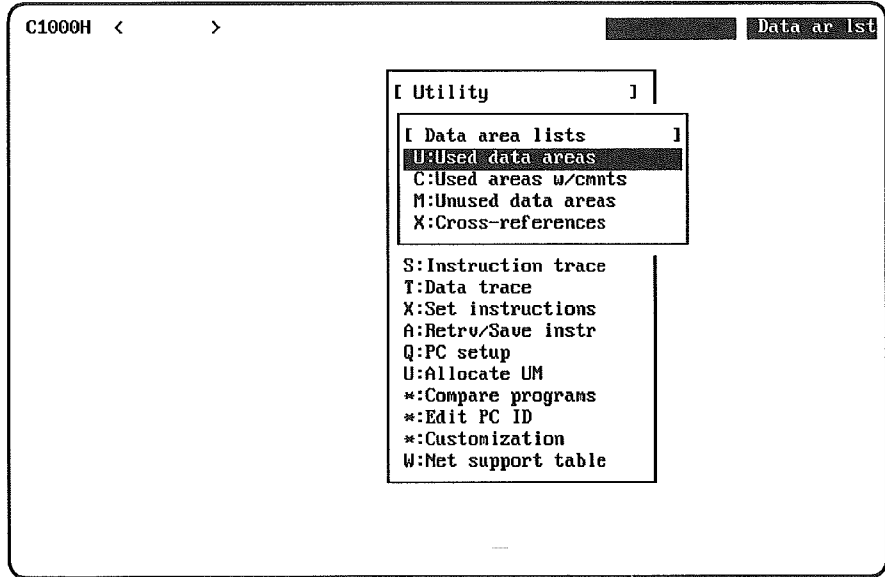

Data area information can be displayed in four ways.

| Operation            | Function   |
|----------------------|--|
| U:Used data areas    | Lists the data area words and bits that are used in the program and how they are used.         |
| C:Used areas w/cmnts | Lists the data area words and bits that are used in the program along with their I/O comments. |
| M:Unused data areas  | Lists the data area words and bits that aren't used in the program.                            |
| X:Cross-references   | Lists a cross-reference of operands in the program.  |

**Note** These 4 lists can also be printed. Refer to 5-4 *Printing Lists* for details.

### 5-2-1 Used Data Areas

This list shows how data areas are used in the program's operands. The procedure is as follows:

- 1, 2, 3... 1. Select "U:Used data areas" from the Data Area Lists Menu. The following menu will be displayed.

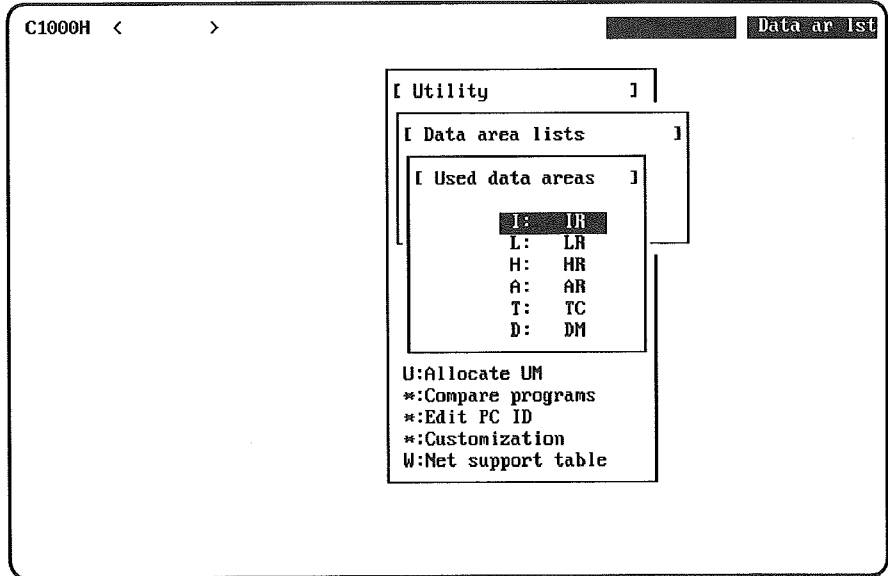

2. Select the desired data area from the Used Data Areas Menu and press Enter. The IR area has been selected in this case.

C1000H <SAMPLE > <<< Used IR list >>>

| Bit Word | 15 | 14 | 13 | 12 | 11 | 10 | 09 | 08 | 07 | 06 | 05 | 04 | 03 | 02 | 01 | 00 |
|----------|----|----|----|----|----|----|----|----|----|----|----|----|----|----|----|----|
| 000      | *  | *  | *  | *  | *  | *  | *  | *  | *  | *  | *  | *  | *  | *  | *  | *  |
| 001      | *  | 0  | 0  | 0  | 0  | 0  | 0  | *  | 0  | *  | *  | *  | *  | *  | *  | *  |
| 002      |    |    |    |    |    |    |    |    |    |    |    |    |    |    |    |    |
| 003      |    |    |    |    |    |    |    |    |    |    |    |    |    |    |    |    |
| 004      |    |    |    |    |    |    |    |    |    |    |    |    |    |    |    | I  |
| 005      |    |    |    |    |    |    |    |    |    |    |    |    | I  | I  | I  | I  |
| 006      |    |    |    |    |    |    |    |    |    |    |    |    |    |    |    |    |
| 007      | I  | I  | I  | I  | I  | I  | I  |    |    |    |    |    |    |    |    |    |
| 008      |    |    |    |    |    |    |    |    |    |    |    |    |    |    |    |    |
| 009      |    |    |    |    |    |    |    |    |    |    |    |    |    |    |    |    |
| 010      |    |    |    |    |    |    |    |    |    | *  | I  |    | I  | I  | I  | I  |
| 011      |    |    |    |    |    |    |    |    |    |    |    |    |    |    |    |    |
| 012      | *  | *  | *  | *  | *  | *  | 0  | 0  | 0  | 0  | 0  | 0  | 0  | 0  | 0  | 0  |
| 013      | 0  | 0  | 0  | 0  | 0  | 0  | 0  | 0  | 0  | 0  | 0  | 0  | 0  | 0  | 0  | 0  |
| 014      | *  | 0  | 0  | 0  | 0  | 0  | 0  | 0  | 0  | 0  | 0  | 0  | 0  | 0  | 0  | 0  |
| 015      |    |    |    |    |    | I  |    |    |    |    |    |    |    |    |    |    |

I: IN  
 O: OUT  
 \*: Both  
 Space: Unused

3. Sixteen words are displayed at a time (or 128 words for DM Area). Use Page-Down and PageUp to scroll the display.
4. While the list is displayed, the desired word can be specified by inputting its address and pressing Enter.
5. Press Escape to return to the Used Data Areas Menu.

### 5-2-2 Used Areas W/Cmnts

This list shows used bits and words with their comments.

- 1, 2, 3...
1. Select "C: Used areas w/cmnts" from the Data Area Lists Menu and press Enter.
  2. Select the desired data area and press Enter. The IR area has been selected in this case.

| C1000H < < < > > >      |     |    |            |     |    |             |     |    |              |
|-------------------------|-----|----|------------|-----|----|-------------|-----|----|--------------|
| Used IR list w/comments |     |    |            |     |    |             |     |    |              |
| Bit                     | 000 | Wd | Comment    | 001 | Wd | Comment     | 002 | Wd | Comment      |
| 00                      | I   |    | IN comment | 0   |    | OUT comment | *   |    | Both comment |
| 01                      | I   |    | IN comment | 0   |    | OUT comment | *   |    | Both comment |
| 02                      | I   |    | IN comment | 0   |    | OUT comment | *   |    | Both comment |
| 03                      | I   |    | IN comment | 0   |    | OUT comment | *   |    | Both comment |
| 04                      | I   |    | IN comment | 0   |    | OUT comment | *   |    | Both comment |
| 05                      | I   |    | IN comment | 0   |    | OUT comment | *   |    | Both comment |
| 06                      | I   |    | IN comment | 0   |    | OUT comment | *   |    | Both comment |
| 07                      | I   |    | IN comment | 0   |    | OUT comment | *   |    | Both comment |
| 08                      | I   |    | IN comment | 0   |    | OUT comment | *   |    | Both comment |
| 09                      | I   |    | IN comment | 0   |    | OUT comment | *   |    | Both comment |
| 10                      | I   |    | IN comment | 0   |    | OUT comment | *   |    | Both comment |
| 11                      | I   |    | IN comment | 0   |    | OUT comment | *   |    | Both comment |
| 12                      | I   |    | IN comment | 0   |    | OUT comment | *   |    | Both comment |
| 13                      | I   |    | IN comment | 0   |    | OUT comment | *   |    | Both comment |
| 14                      | I   |    | IN comment | 0   |    | OUT comment | *   |    | Both comment |
| 15                      | I   |    | IN comment | 0   |    | OUT comment | *   |    | Both comment |

I: IN    O: OUT    \*: Both    Space: Unused

[ ]

3. Three words can be displayed at a time. Use PageDown and PageUp to scroll the display.
4. While the list is displayed, the desired word can be specified by inputting its address and pressing Enter. The specified word and two subsequent words will be displayed.
5. Press Escape to return to the Used Data Areas Menu.

### 5-2-3 Unused Data Areas

This list shows unused bits and words.

- 1, 2, 3...
1. Select "M:Unused data areas" from the Data Area Lists Menu and press Enter.
  2. Select the desired data area and press Enter again. The IR area has been selected in this case.

C1000H <SAMPLE >

< < < Unused IR list > > >

| Bit<br>Word | 15 | 14 | 13 | 12 | 11 | 10 | 09 | 08 | 07 | 06 | 05 | 04 | 03 | 02 | 01 | 00 |
|-------------|----|----|----|----|----|----|----|----|----|----|----|----|----|----|----|----|
| 000         |    |    |    |    |    |    |    |    |    |    |    |    |    |    |    |    |
| 001         |    |    |    |    |    |    |    |    |    |    |    |    |    |    |    |    |
| 002         |    |    |    |    |    |    |    |    |    |    |    |    |    |    |    |    |
| 003         |    |    |    |    |    |    |    |    |    |    |    |    |    |    |    |    |
| 004         |    |    |    |    |    |    |    |    |    |    |    |    |    |    |    |    |
| 005         |    |    |    |    |    |    |    |    |    |    |    |    |    |    |    |    |
| 006         |    |    |    |    |    |    |    |    |    |    |    |    |    |    |    |    |
| 007         |    |    |    |    |    |    |    |    |    |    |    |    |    |    |    |    |
| 008         |    |    |    |    |    |    |    |    |    |    |    |    |    |    |    |    |
| 009         |    |    |    |    |    |    |    |    |    |    |    |    |    |    |    |    |
| 010         |    |    |    |    |    |    |    |    |    |    |    |    |    |    |    |    |
| 011         | 0  | 0  | 0  | 0  | 0  | 0  | 0  | 0  | 0  | 0  | 0  | 0  | 0  | 0  | 0  | 0  |
| 012         | 0  | 0  | 0  | 0  | 0  | 0  | 0  | 0  | 0  | 0  | 0  | 0  | 0  | 0  | 0  | 0  |
| 013         | 0  | 0  | 0  | 0  | 0  | 0  | 0  | 0  | 0  | 0  | 0  | 0  | 0  | 0  | 0  | 0  |
| 014         | 0  | 0  | 0  | 0  | 0  | 0  | 0  | 0  | 0  | 0  | 0  | 0  | 0  | 0  | 0  | 0  |
| 015         | 0  | 0  | 0  | 0  | 0  | 0  | 0  | 0  | 0  | 0  | 0  | 0  | 0  | 0  | 0  | 0  |

0: Unused  
Space: Used

[ ]

3. Sixteen words are displayed at a time (128 words for DM Area). Use PageDown and PageUp to scroll the display.
4. While the list is displayed, the desired word can be specified by inputting its address and pressing Enter.
5. Press Escape to return to the Used Data Areas Menu.

### 5-2-4 Cross References

This list shows a cross-reference of operands in the program. The procedure is as follows:

- 1, 2, 3... 1. Select "X:Cross-references" from the Data Area Lists Menu and press Enter.
2. Select the desired data area, press Enter, input a bit or word address, and press Enter. The program addresses and instruction using the designated bit as an operand will be displayed. IR 00001 has been selected in this case.

C1000H <SAMPLE >

00001 <<< Cross - reference list >>>

| Address instruction | Address instruction | Address instruction |
|---------------------|---------------------|---------------------|
| 00009- ( )          | 00171- ( )          |                     |
| 00011-              | 00175- [ ] KEEP(11) |                     |
| 00050-              | 00215-Word SFT (10) |                     |
| 00061- /            | 00217-              |                     |
| 00064-              | 00256-              |                     |
| 00074-              | 00267- /            |                     |
| 00092-              | 00270-              |                     |
| 00102- /            | 00280-              |                     |
| 00114-              |                     |                     |
| 00119- /            |                     |                     |
| 00139-              |                     |                     |
| 00147- /            |                     |                     |
| 00165-              |                     |                     |
| 00168-              |                     |                     |

3. Use PageDown and PageUp to scroll the display.
4. Use the Up and Down Cursor Keys to increment and decrement the operand being displayed.
5. Press Escape to return to the Cross-reference Menu.

## 5-3 Globally Changing Addresses

These three operations are used to globally change the bit or word addresses used in a program in the system work area. The operator can also specify whether the I/O comments are to be changed at the same time. The "Change addresses" operations can save a great deal of time when the I/O configuration has been changed or an existing program is being modified for a new system.

The following table shows which operands/instructions can be changed with these operations.

| Operation        | Operands/instructions changed |       |                           |               |     |               |
|------------------|-------------------------------|-------|---------------------------|---------------|-----|---------------|
|                  | IR, LR, HR, AR                |       | TIM, CNT                  |               | DM  | Range setting |
|                  | Bits                          | Words | Bit operands/instructions | Word operands |     |               |
| R:Bits/TIM/CNT   | Yes                           | No    | Yes                       | No            | No  | TIM, CNT      |
| C:Words          | No                            | Yes   | No                        | Yes           | Yes | All           |
| W:Words and Bits | Yes                           | Yes   | No                        | No            | No  | All           |

**Note** (Yes: Can be changed, No: Cannot be changed)

**Modifying Programs** If you are modifying a program accompanying changes to a system or to use a program for another system, the following basic steps will probably be necessary.

- 1, 2, 3...
1. Define the changes necessary for the new system.
  2. Modify the program as necessary, using global address changes where possible to save time.
  3. Regenerate or otherwise correct the I/O table for the new system.
  4. Correct I/O comments as required.

### 5-3-1 Changing Bit Addresses and TIM/CNT Numbers

This operation can be used to change individual bits in the IR, LR, AR, and HR Areas and ranges of timer/counter numbers.

The change will not be performed if an error occurs during execution.

**Bit Addresses** This operation changes bit operands, but does not change affect word operands. The data area in which the bit is located can be changed, e.g., HR 0003 can be replaced by TIM 010.

**Timer/Counter Numbers** Timer/counter numbers used as bit operands and timer/counter numbers in timer/counter instructions will be changed. Timer/counter numbers used as word operands (i.e., accessing the PV) are not changed.

When a TIM number is changed to another TIM number or a CNT number is changed to another CNT number, the TIM/CNT instructions will be changed at the same time as operands.

When a TIM number is changed to a CNT number or a CNT number is changed to a TIM number, or when a timer/counter number is changed to a bit address, the TIM/CNT instructions will not be changed at the same time as operands.

**I/O Comments** You can specify whether or not I/O comments are to be changed for replacements. If the specified bit address does not exist in the program, a "Nothing found" message will be displayed and the bit addresses and I/O comments will not be changed. For a range of timer/counter numbers, all of the bit operands and I/O comments will be changed if there is even one used in the program.

If "Change I/O comment" on the replacement Menu is set to "N," the I/O comment for the new bit address will be used. If the changed bit address has no I/O comment, no I/O comment will be displayed. In the following example, IR 00001 is changed to IR 00003 and "Change I/O comment is set to "N."

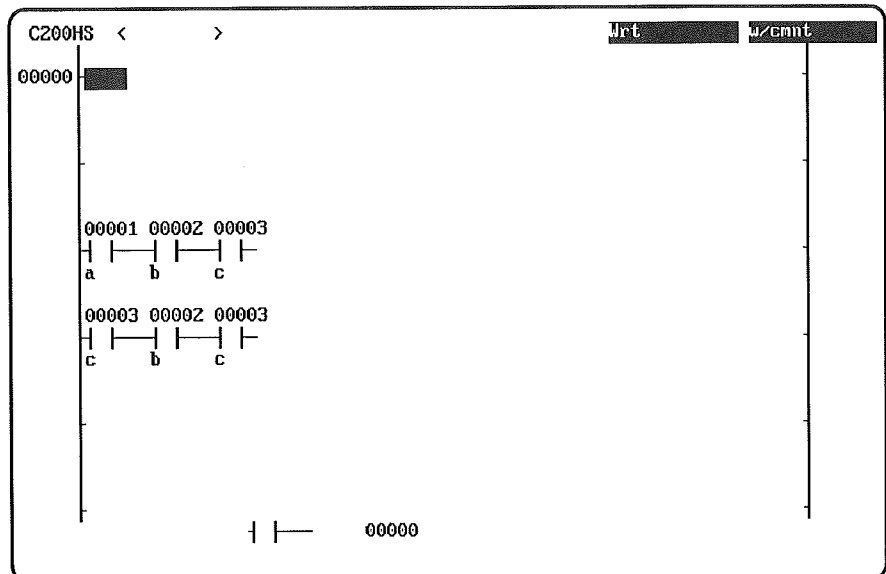

If "Change I/O comment" on the replacement Menu is set to "Y," the I/O comment for the bit address before the change will remain if the new bit address has no I/O comment. If the I/O comments differ for the bit addresses before and after the change, the I/O comment for the old bit address will be used. In the following example, IR 00001 is changed to IR 00003 and "Change I/O comment is set to "Y."

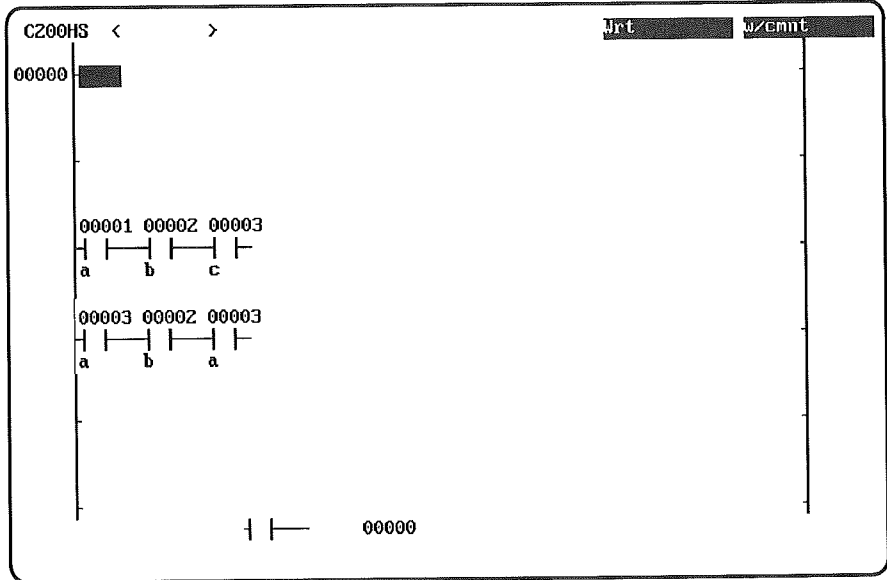

**Procedure** The procedure for replacing bits and timer/counter numbers is as follows:

- 1, 2, 3... 1. Select "I:Change addresses" from the Utility Menu.

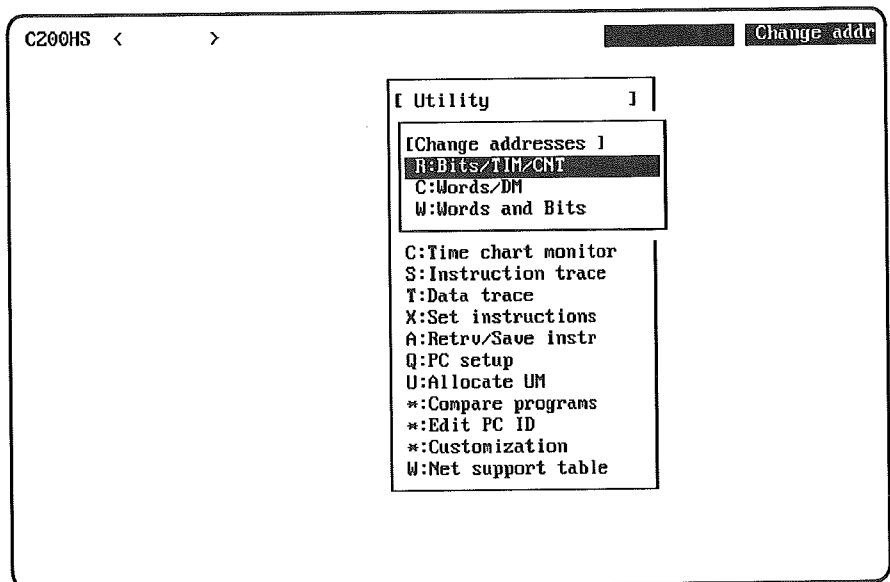

2. Select "R:Bits/TIM/CNT" from the menu.

```

C200HS < > [Change addr]
[ Utility ]
[Change addresses ]
[ Bits/TIM/CNT ]
Old begin Bit IR 00000
Old end Bit IR 00000
New begin Bit IR 00000
Change comments also? N
Confirm (Y/N)? Y
*:Customization
W:Net support table

```

3. Enter the first address to be changed and press Enter.
4. To change only one bit/number, press Enter again.
5. Enter the new bit address/number.  
When changing multiple TIM or CNT, enter the new number for the first address.
6. Set whether the I/O comments are to be changed.
7. To execute the change press Enter in response to the confirmation message.  
A message will flash to indicate that the changes are being made and the program name will be displayed. The message and program name will be cleared from the screen when the changes are complete.

### 5-3-2 Changing Word Addresses

This operation can be used to change word addresses in the IR, LR, AR, HR, and DM Areas, as well as timer/counter numbers used as word operands. The change will not be performed if an error occurs during execution.

#### Word Addresses

Word addresses in the IR, LR, AR, HR, and DM Areas can be changed. The data area in which the word is located can also be changed, e.g., IR 001 can be replaced by DM 0003.

Individual bits will not be changed. In the following example, IR 001 is replaced by IR 002 but individual bits in IR 001 are not affected.



Before

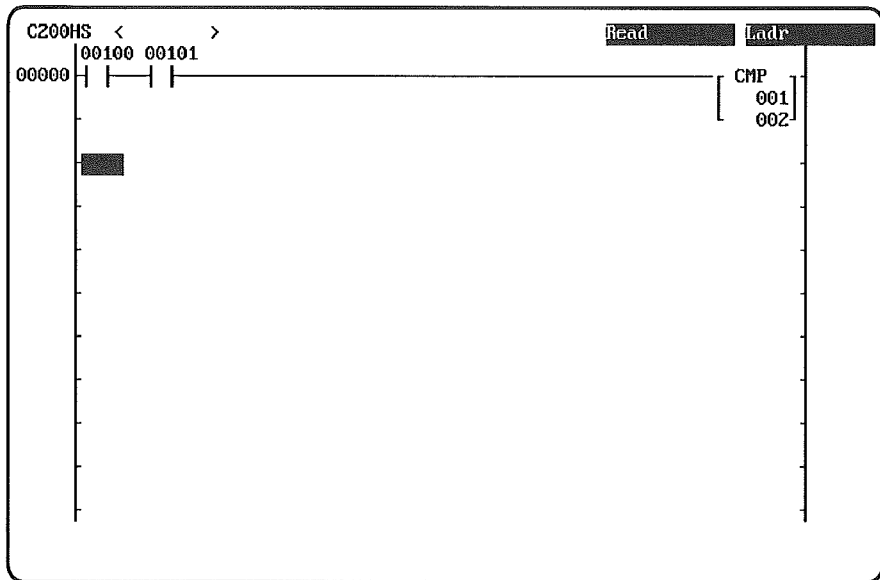

After

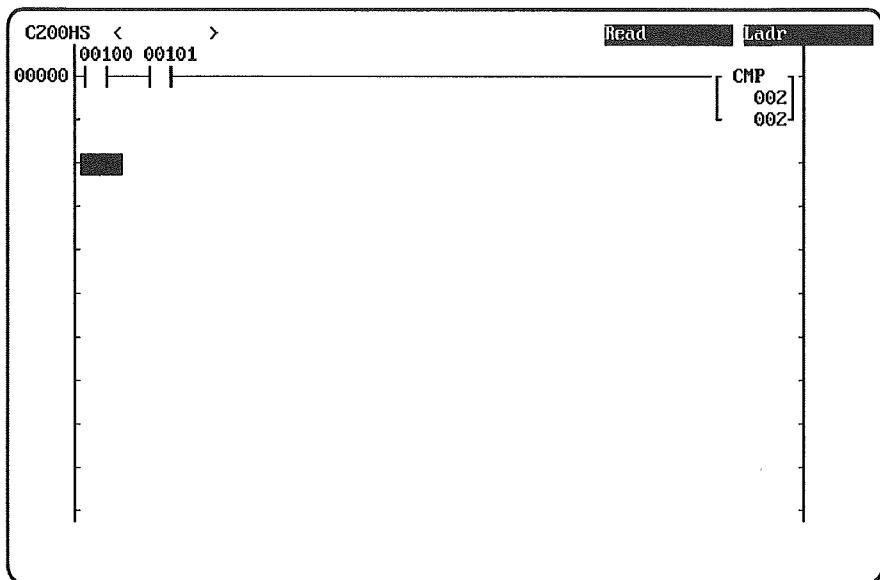

**TIM/CNT Numbers**

Only timer/counter numbers used as word operands (i.e., those accessing the PV) are changed. Timer/counter numbers used as bit operands and TIM/CNT instructions are not changed. A timer number can be changed to a counter number and vice-versa.

**Range Setting**

A single word or a continuous range of words can be changed. To change just one word, use the same word address for the first word and last word in the range. To change more than one word, use a higher word address for the last word in the range. The first and last word must be in the same data area. The range of addresses before the change can overlap the range of addresses after the change.

**I/O Comments**

You can specify whether or not I/O comments are to be changed for replacements. I/O comments will be changed for the specified words but not for bits.

For a range of words, all of the word addresses and I/O comments will be changed if there is even one used in the program. If the specified word address does not exist in the program, a "Nothing found" message will be displayed and the word addresses and I/O comments will not be changed.

In other respects, I/O comments for words are changed like I/O comments for bit addresses. Refer to 5-3-1 *Changing Bit Addresses and TIM/CNT Numbers* for examples.

**Procedure**

The procedure for replacing word addresses is as follows:

- 1, 2, 3... 1. Select "I:Change addresses" from the Utility Menu.

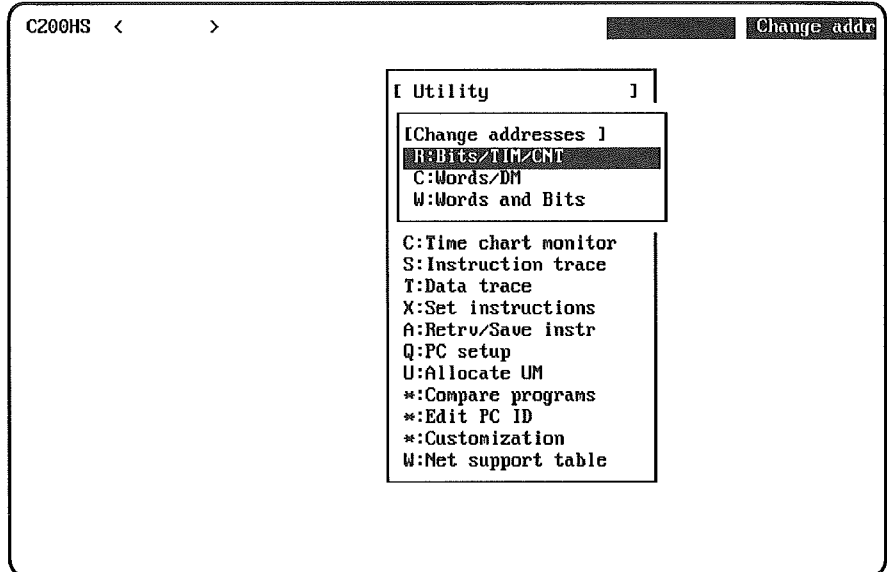

2. Select "C:Words" from the menu.

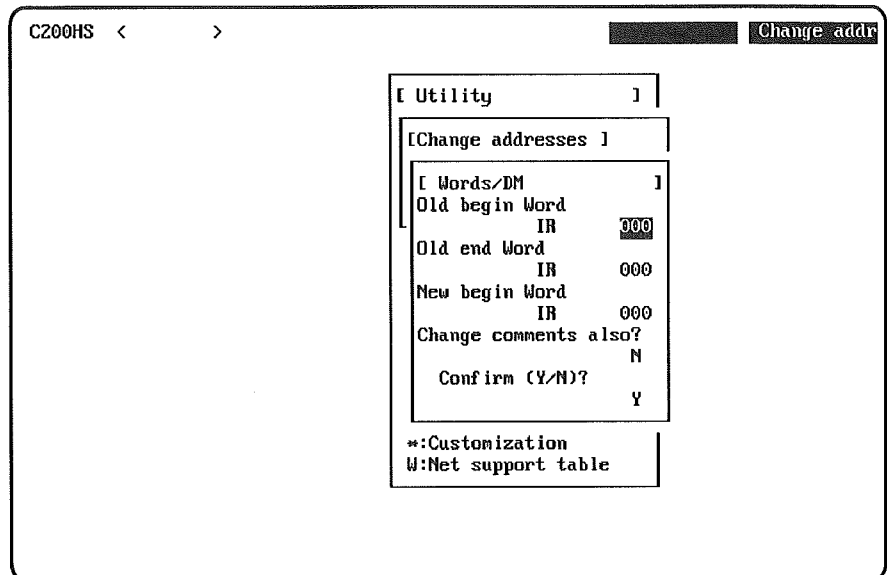

3. Enter the first address to be changed and press Enter.  
 4. To change only one word address, press Enter again.  
 or To change a range of addresses, enter the last address to be changed.  
 The first and last address must be in the same data area and the first address must be lower than the last.

5. Enter the new word address. When a range of addresses is being changed, this address is the first in the new range of addresses.
6. Set whether the I/O comments are to be changed.
7. To execute the change press Enter in response to the confirmation message.  
 A message will flash to indicate that the changes are being made and the program name will be displayed. The message and program name will be cleared from the screen when the changes are complete.

### 5-3-3 Changing Word and Bit Addresses

This operation can be used to change all word and bit addresses in the IR, LR, AR, and HR Areas. Addresses in the DM area and timer/counter numbers cannot be changed. The change will not be performed if an error occurs during execution.

#### Word/Bit Addresses

Word and bit addresses in the IR, LR, AR, and HR Areas can be changed. The data area can also be changed, as in the following example where IR 001 is replaced by AR 03.

**Before**

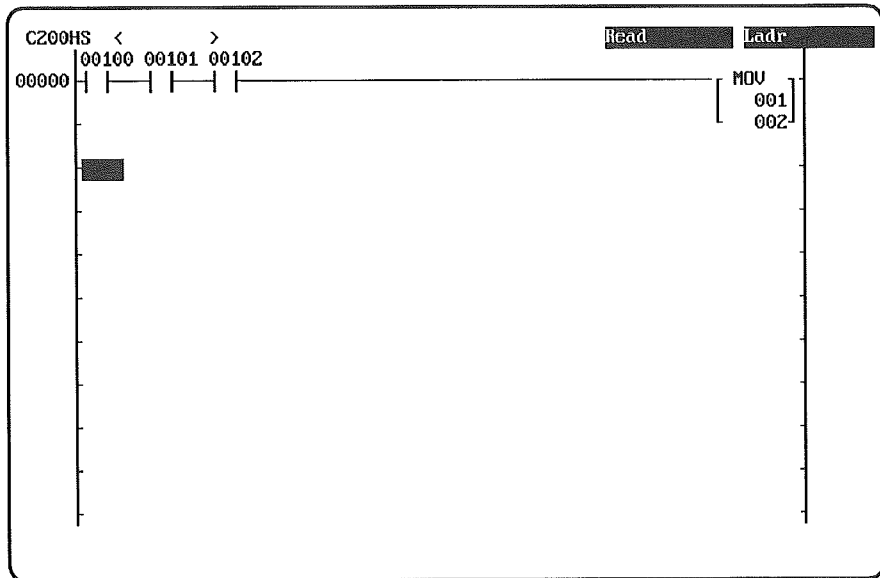

After

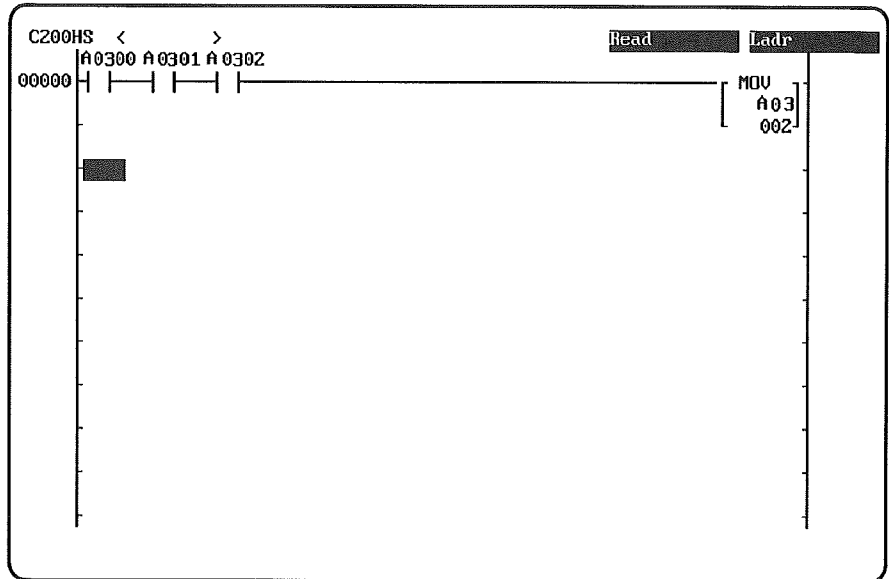

**Range Setting** A single word or a continuous range of words can be changed. To change just one word and its bits, use the same word address for the first word and last word in the range.

To change more than one word, use a higher word address for the last word in the range. The first and last word must be in the same data area. The range of addresses before the change can overlap the range of addresses after the change.

**I/O Comments** I/O comments for words can be changed like I/O comments for bit addresses. Refer to 5-3-1 Changing Bit Addresses and TIM/CNT Numbers for examples.

**Procedure** The procedure for replacing word/bit addresses is as follows:

- 1, 2, 3... 1. Select "I:Change addresses" from the Utility Menu.

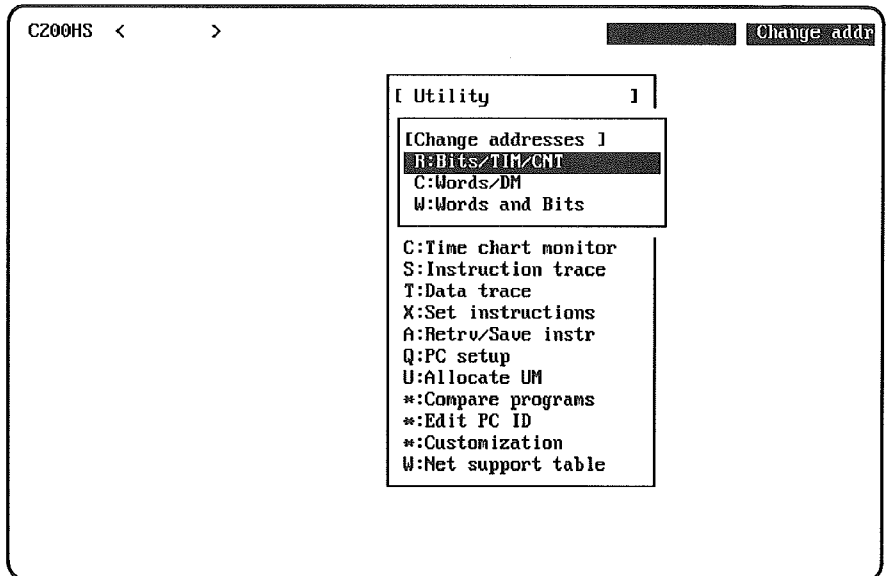

2. Select "W:Words and Bits" from the menu.

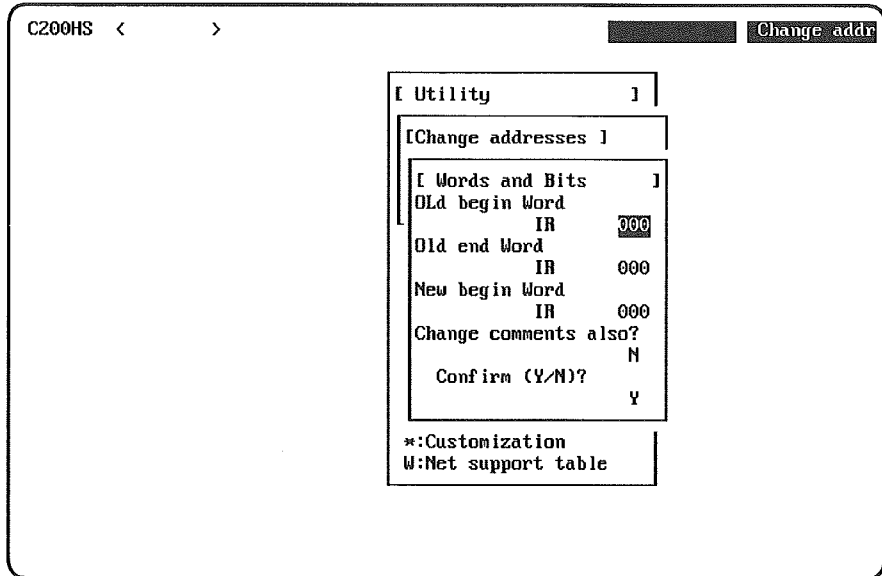

3. Enter the first address to be changed and press Enter.
4. To change only one word address, press Enter again.
- or To change a range of addresses, enter the last address to be changed.  
The first and last address must be in the same data area and the first address must be lower than the last.
5. Enter the new word address. When a range of addresses is being changed, this address is the first in the new range of addresses.
6. Set whether the I/O comments are to be changed.
7. To execute the change press Enter in response to the confirmation message.  
A message will flash to indicate that the changes are being made and the program name will be displayed. The message and program name will be cleared from the screen when the changes are complete.

## 5-4 Printing Lists

These operations print data lists based on the program stored in the system work area. When the printer is set for ASCII, however, the following data lists cannot be printed: Used Areas W/ Cmnts, Unused Data Areas and Ladder Diagram & I/O.

The following table shows the 7 lists that can be printed from the Print Lists Menu. Select an operation by pressing its corresponding letter or moving the cursor to the operation and pressing Enter. These operations are described briefly in the following table and in more detail in later sections.

| Operation               | Function  |
|-------------------------|---|
| U:Used data areas       | Lists the bits and words used in the program.   |
| C:Used areas w/cmnts    | Lists the bits and words used in the program with I/O comments.   |
| M:Unused data areas     | Lists the bits and words that aren't used in the program.   |
| Z:Used data areas (all) | Lists all bits and words and indicates which are used in the program.   |
| X:Cross-references      | Lists all instruction in which the specified bit or word is used in the program.                                      |
| L:Ladder diagram        | Prints out the program as a ladder diagram.   |
| I:Ladder diagram & I/O  | Prints out the program as a ladder diagram. Letters X and Y show whether bits are allocated to Input or Output Units. |
| N:Mnemonic              | Prints out the program in mnemonic code.  |

Before printing, verify that a printer is connected to the computer and that it is correctly set. An error message won't be displayed if a printer isn't connected to the host computer. (The message "Printing" will flash indefinitely.)

A message will be displayed if a printer is connected but unable to print. In this case, press Escape, correct the problem, and try again.

Refer to the printer setting on the System Setup to set the printer model.

### 5-4-1 Used Data Areas

Follow this procedure for the Used Data Areas, Used areas w/cmnts, and Used Data Areas (All) operations. The Used Data Areas prints a list of the bits and words used in the program, Used Areas W/Cmnts also prints I/O comments, and Used Data Areas (All) prints a list of all bits and words with I/O comments whether or not the bits and words are used in the program.

- 1, 2, 3...
1. Verify that the computer is connected to a printer and the printer is online.
  2. Select "P:Print lists" from the Utility Menu and press Enter.

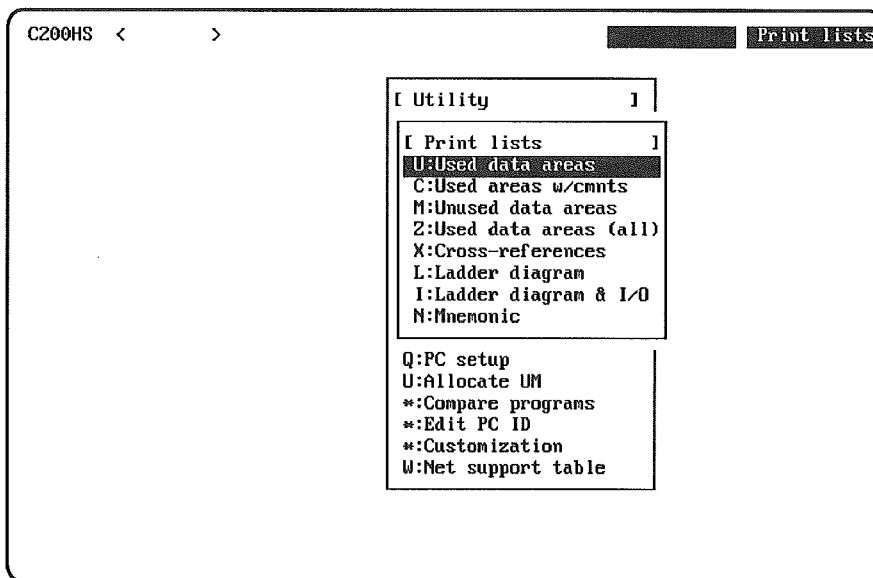

3. Select the desired list and press Enter.

In this example, Used Data Areas was selected, but the procedure is the same for Used Areas W/Cmnts and Used Data Areas (All).

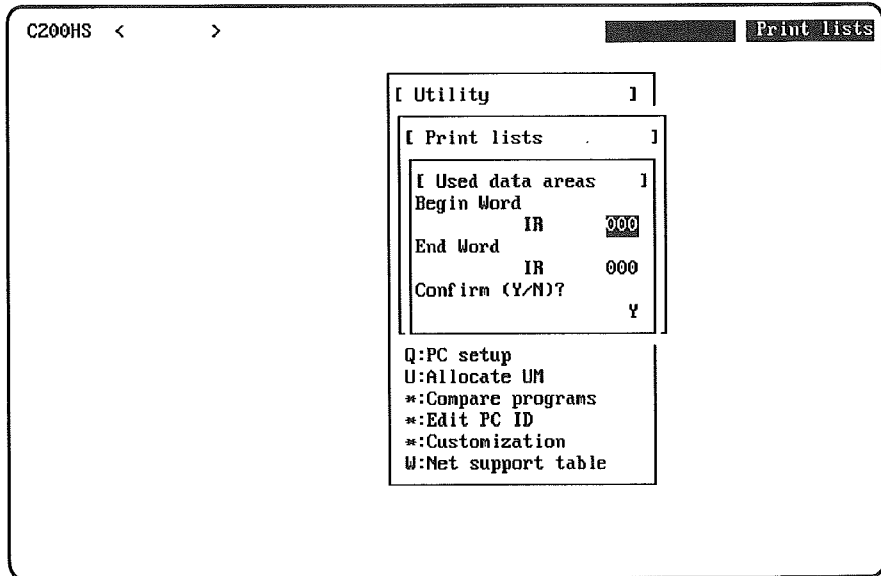

4. Specify a data area. Press Enter to specify the IR area, or Ctrl+F1 through Ctrl+F7 for the other data areas.
5. Input the first and last addresses to be printed.
6. To print press Enter in response to the confirmation message.

The message "Printing" will be displayed until printing is complete. The menu display will return when printing is complete. Press Escape at any time to interrupt printing and return to the Printer Menu. (The printer will continue printing until its memory buffer is empty.)

### 5-4-2 Unused Data Areas

Follow this procedure for the Unused Data Areas. The Unused data areas operation prints a list of the bits and words that aren't used in the program.

- 1, 2, 3...
1. Verify that the computer is connected to a printer and the printer is online.
  2. Select "P:Print lists" from the Utility Menu and press Enter.

3. Select "M:Unused data areas" from the Menu and press Enter.

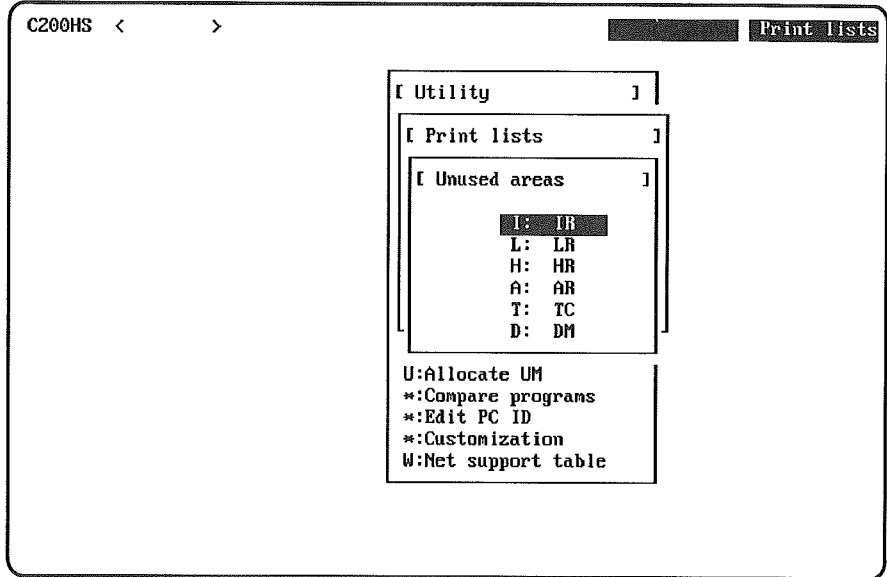

4. Specify a data area to start printing.

The message "Printing" will be displayed until printing is complete. The Menu display will return when printing is complete. Press Escape at any time to interrupt printing and return to the Printer Menu. (The printer will continue printing until its memory buffer is empty.)

### 5-4-3 Cross References

Follow this procedure to print cross-references. When cross-references are displayed on screen, information for the specified bit alone is displayed, but when the cross-references are printed, information is printed for the all of the bits that are used.

1, 2, 3...

1. Verify that the computer is connected to a printer and the printer is online.
2. Select "P:Print lists" from the Utility Menu and press Enter.
3. Select "X:Cross-references" from the Menu and press Enter.

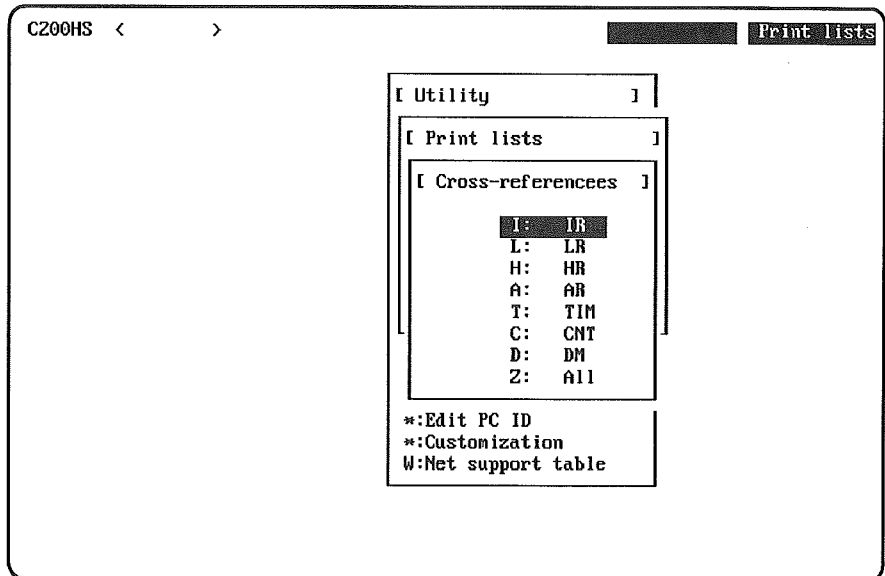



4. Specify a data area. A input area for the title will appear.
5. Input a title for the list (up to 20 characters) and press Enter. The title will be printed at the top of the list.

The message "Printing" will be displayed until printing is complete. The menu display will return when printing is complete. Press Escape at any time to interrupt printing and return to the Printer Menu. (The printer will continue printing until its memory buffer is empty.)

### 5-4-4 Ladder Diagrams

This operation prints the program in the system work area in ladder diagram form. The table shows printer settings which must be checked before printing.

| Item                  | Input           | Description   |
|-----------------------|-----------------|---|
| Lines per page        | 66 to 132       | Specifies the number of lines per page.                               |
| Begin address         | Program address | Specifies the beginning of the program section that will be printed.  |
| End address           | Program address | Specifies the end of the program section that will be printed.        |
|                       | E               | Print to the first END instruction in the program.                    |
|                       | A               | Print entire program. (Past END instructions if the program goes on.) |
| Title                 | Character input | Enter the title which will appear on the printout.                    |
| I/O comments          | Y               | Print I/O comments.   |
|                       | N               | Do not print I/O comments.  |
| Instruction comments  | Y               | Print instruction comments.   |
|                       | N               | Do not print instruction comments.                                    |
| Block comments        | Y               | Print block comments.   |
|                       | N               | Do not print block comments.  |
| Change pages?         | Y               | Do not print over the perforations in the computer paper.             |
|                       | N               | Continuous printing, ignoring the perforations in the computer paper. |
| Cross-reference level | 0               | Do not print cross-references.  |
|                       | 1               | Print cross-references only for instructions controlling bit status.  |
|                       | 2               | Print cross-references for all instructions.                          |
| Begin page            | Numeric input   | Enter the page number of the first page to be printed.                |
| Confirm?              | Y               | Start printing.   |
|                       | N               | Correct the settings.   |

If the printer is set for ASCII printing, the title, I/O comments, instruction comments, block comments, and cross-references will not be printed.

Follow this procedure to print ladder diagrams:

- 1, 2, 3...
  1. Verify that the computer is connected to a printer and the printer is online.
  2. Select "P:Print lists" from the Utility Menu and press Enter.

3. Select "L:Ladder diagram" from the Menu and press Enter. The ladder diagram settings will be displayed. If a ladder diagram was previously printed, its settings will be displayed.

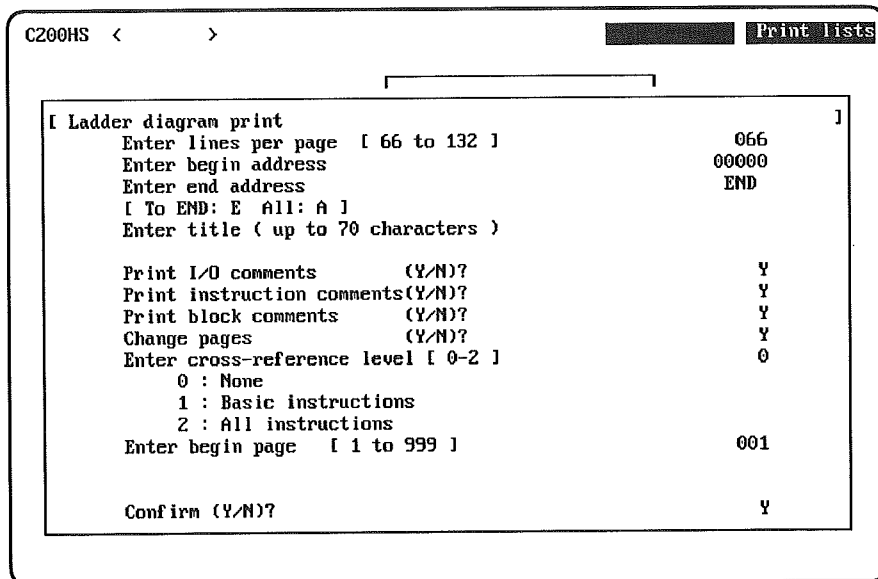

4. If no change is required, go to step 13.
- or If new parameters are to be specified or if nothing was previously printed, input the desired data in response to each message on the display.
5. Enter the number of lines to be printed per page. Enter 66 when using 11x15 paper. This setting is effective only if the "Change pages" setting is set to Y.
6. Input the starting address where printing will begin and press Enter.
7. Input the end address (the last address to be printed) and press Enter.
- or Press E and Enter if you want the instructions in the ladder diagram up to the END instruction to be printed.
- or Press A to print all the instructions including those following the END instruction.
8. Input a title (up to 70 characters) under which the ladder diagram will be printed and press Enter.
9. Press Y and Enter if you want the comments to be printed. Press N and Enter if you don't want the comments to be printed.
10. Press N and Enter if you want the ladder diagram to be continuously printed over several pages. Press Y and Enter if not.
11. Specify one of the three levels of cross-references and press Enter. Press "0" if you don't want a cross-referenced list to be printed, "1" if you want normally open and normally closed output instructions to be printed, and "2" if you want the current cross-reference list, including all instructions, to be printed.
12. Specify the start page number from which printed pages will be numbered and press Enter.
13. After specifying the above parameters, press Enter to begin printing.
- or If you want to edit data, press N and Enter, re-input the desired data and press Enter to print.
14. The message "Printing" will be displayed until printing is complete. The Menu display returns when printing is complete.  
Press Escape at any time to return to the PRINTER menu. Printing does not stop, however, until all the data in the computer's printer buffer has been printed.

15. Press Escape to return to the Utility Menu.

### 5-4-5 Ladder Diagrams & I/O

This operation prints the program in the system work area in ladder diagram form and indicates whether bits are allocated to Input or Output Units. An X will be printed before input bit addresses; a Y, before output bit addresses.

For most PCs the system determines I/O allocation by referencing the I/O table in the system work area. Therefore, the I/O table must first be written to the system work area or transferred from the PC in the online mode before this command can be executed. For CQM1 PCs, input prompts appear for the maximum input word and maximum output word; the system uses these settings to determine I/O allocations.

This operation is not possible if the printer is set for ASCII printing.

**Note** Incorrect I/O classifications will be printed if there is no I/O table in the system work area.

**Procedure** Follow this procedure for the Ladder Diagram & I/O operation:

- 1, 2, 3...
  1. Verify that the computer is connected to a printer and the printer is online.
  2. Select "P:Print lists" from the Utility Menu and press Enter.
  3. Select "I:Ladder diagram & I/O" from the Menu and press Enter.

The remainder of the procedure is identical to the procedure for Ladder Diagram. Refer to 5-4-4 *Ladder Diagrams* for details.

### 5-4-6 Printing Mnemonics

This operation prints the program in the system work area in mnemonic form.

- 1, 2, 3...
  1. Verify that the computer is connected to a printer and the printer is online.
  2. Select "P:Print lists" from the Utility Menu and press Enter.
  3. Select "N:Mnemonic" from the Menu and press Enter. The printer settings will be displayed. If a program has been printed, its settings will be displayed.

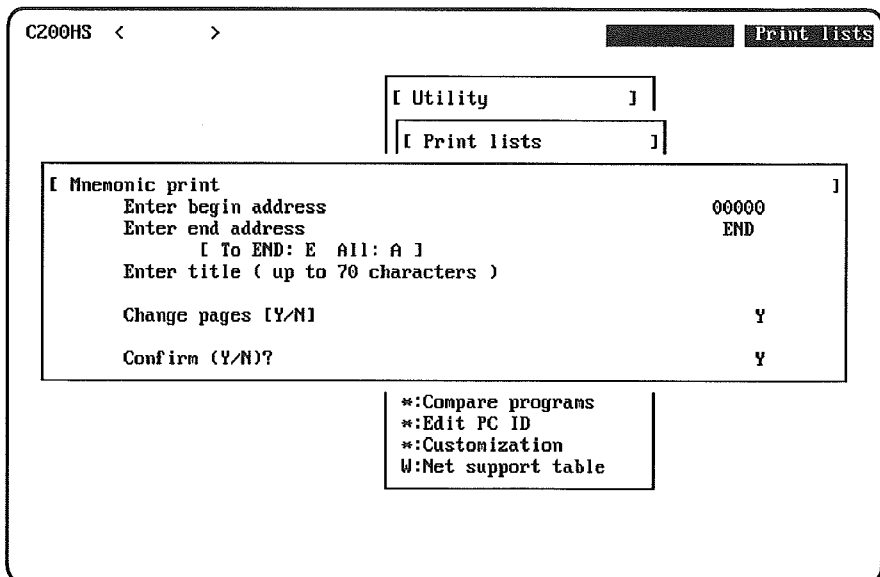

- 4. If no change is required, go to step 5.
- or If new parameters are to be specified or if nothing was previously printed, input the desired data in response to each message on the display.

| Item          | Input     | Description   |
|---------------|-----------|---|
| Begin address | Numeric   | First address of the program section to be printed.                   |
| End address   | Numeric   | Last address of the program section to be printed.                    |
|               | E         | Print to the first END instruction in the program.                    |
|               | A         | Print entire program.   |
| Title         | Character | Enter the title (70 characters max.).                                 |
| Change pages  | Y         | Do not print over the perforations in the computer paper.             |
|               | N         | Continuous printing, ignoring the perforations in the computer paper. |

- 5. After specifying the above parameters, press Enter to begin printing.
- or If you want to edit data, press N and Enter, re-input the desired data and press Enter to print.
- 6. The message "Printing" will be displayed until printing is complete. The Menu display returns when printing is complete.  
  
Press Escape at any time to return to the PRINTER menu. Printing does not stop, however, until all the data in the computer's printer buffer has been printed.
- 7. Press Escape to return to the Utility Menu.

## 5-5 Manipulating EPROM

"EPROM Functions" is used to read, write, and verify programs on ROM through a PROM Writer connected to the computer or to generate an Intel HEX file. These functions are supported when a C-series PC is being used.

The following commands can be executed.

| Command           |          | Description  |
|-------------------|----------|--|
| T:Computer ↔ ROM  | R:Read   | Reads the program written in the PROM Writer to the computer.  |
|                   | W:Write  | Writes the program on the computer to the PROM Writer  |
|                   | V:Verify | Compares the program on the computer to that of the PROM Writer.<br><br>When the program is read from or written to the PROM Writer, verification is not necessary because it is automatically executed.   |
| M: Intel HEX file |          | An Intel HEX file will be created from the program on the computer using the designated file name.<br><br>To create an Intel HEX file from the program contained in the PROM Writer, read the program written in the PROM Writer to the computer and then create the file. |

Comments (including I/O, instruction, and block comments) cannot be written to the PROM Writer or Intel HEX file. When the program is read from the PROM Writer to the computer, the comments on the computer are erased.

**Program Conversion**

The program displayed on the computer is written in an intermediate language, whereas the program of the PROM Writer is written in the machine language of the PC. Therefore, when the program is read, written, or verified between the PROM Writer and the computer, the language is converted between the intermediate and machine languages through a data buffer, as illustrated below.

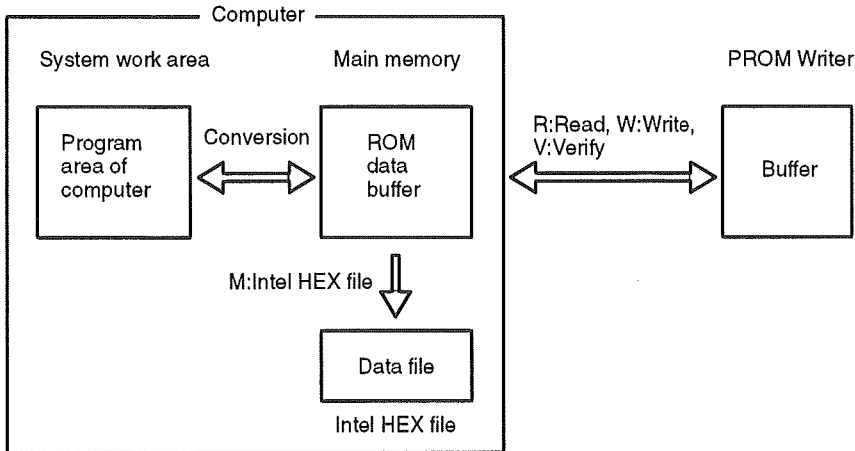

**System Setup**

The I/O table, data link tables (C500, C1000H, C2000H, C200HS, C200HX/C200HG/C200HE), battery voltage detection setting, and the instructions table (CQM1, C200HS, C200HX/C200HG/C20HE) can be written to the PROM in addition to the program. To write this data, set the I/O table — UM transfer parameter in the System Setup. Transfer of fixed DM data (C200H, Mini H-type PCs) is set when it is written to the PROM.

When writing the I/O table and data link table to the PROM, be sure to store the proper tables in the system work area first.

**PROM Writer Settings**

The following table shows the PROM Writer settings. The data length for data transfer between the computer and PROM Writer is either 32 or 64 bits, excluding the header.

| Item            | Set value                                |
|-----------------|--|
| Transfer format | Intel HEX                                |
| Transfer bits   | 7-bit data, 2 stop bits, even parity     |
| Baud rate       | Same setting as on the System Setup menu |

Refer to your user's manuals for details on operating your PROM Writer and the ROM chips that can be used with the PROM Writer.

**5-5-1 Chip Selection and Chip Number Assignments**

Check the size of the program stored in the system work area by using the Memory Usage command of the Programming Menu and determine the capacity of the ROM needed.

When ROM chips are mounted on the ROM Unit of the PC, assign the numbers corresponding to the mounting positions of the ROM chips. These numbers are called chip numbers. The chip numbers are assigned differently depending on the model of the PC and the type of ROM (ROM size).

For details, refer to your PC's operation manual.

**C20, P-type PCs, K-type PCs, and C120** For C20, P-type, K-type and C120 PCs, use one 2764 chip and always set the chip number to 0.

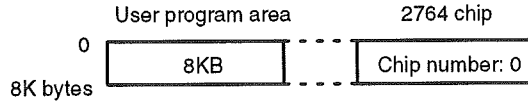

**CQM1** For the CQM1, use one 27128, 27256, or 27512 chip and set the chip number to 0.

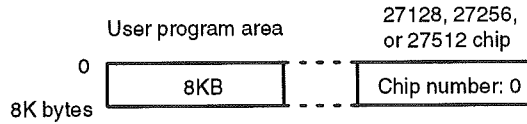

**C200H** For the C200H, use one 150-ns or 200-ns 27128 chip and set the chip number to 0. (Do not use a 250-ns 27128 chip.)

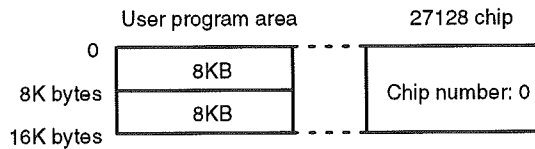

**C200HS/ C200HX/ C200HG/ C200HE** For the C200HS, use one 27256 or 27512 chip and set the chip number to 0.

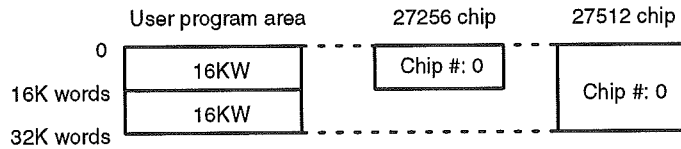

**Mini H-type PCs** For Mini H-type PCs, use one 2764, one 150-ns or 200-ns 27128, or one 27256 chip and set the chip number to 0.

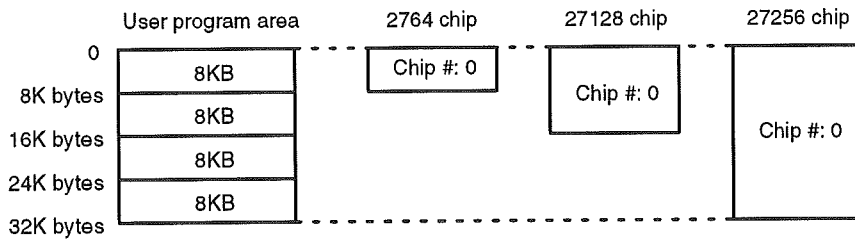

**C500** For the C500, the amount of ROM needed depends upon the size of the program. Combine 2764 and 27128 chips to provide the required capacity. The following configurations provide 24K bytes of storage.

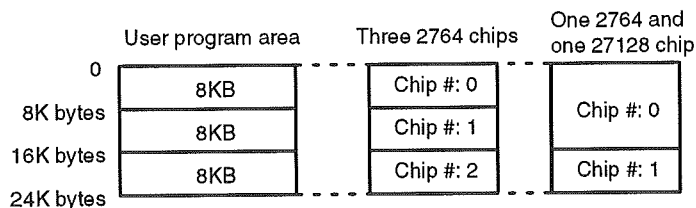

**C1000H and C2000H**

Use the same type of ROM in pairs for chip numbers 0 and 1, 2 and 3, and 4 and 5, respectively. If an odd number of ROM chips is used, the PC will not operate, nor can the program be converted when it is transferred between the PC and computer. Use 150-ns ROM for C1000H/C2000H. The 200-ns and 250-ns ROM cannot be used.

The following configurations provide up to 24K words of capacity. (The proper chip number settings are shown in the boxes.)

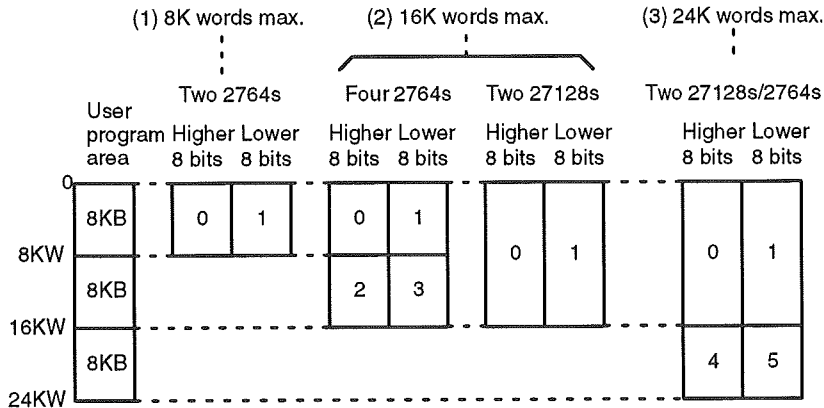

The following configurations provide up to 32K words of capacity. (The proper chip number settings are shown in the boxes.)

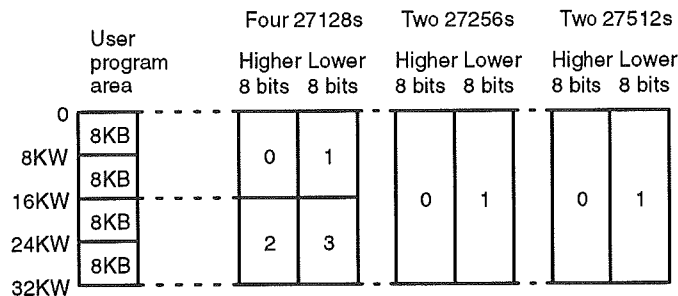

To mount the ROM chips to which the program has been written to the ROM Unit, mount chips 0 to 3 to the IC sockets CHIP 0 to 3 of the ROM Unit. If the capacity is 24K words, mount chips 4 and 5 to CHIP 2 and 3, respectively.

**5-5-2 Writing to EPROM**

This operation writes the program from the system work area to the PROM Writer.

1, 2, 3...

1. Insert a blank EPROM chip in the PROM Writer.
2. Select "R:EPROM/Memory Card" from the Utility Menu.
3. Select "T :Computer ↔ ROM."
4. Specify the EPROM size. Refer to 5-5-1 *Chip Selection and Chip Number Assignment* for details on compatible ROM types. In this example, a ROM size of 16k bytes is selected.

| ROM chip | Size      |
|----------|-----------|
| 2764     | 8K bytes  |
| 27128    | 16K bytes |
| 27256    | 24K bytes |
| 27512    | 64K bytes |

5. Set the PROM Writer to the reception mode.
6. Select "W :Write" from the Menu.

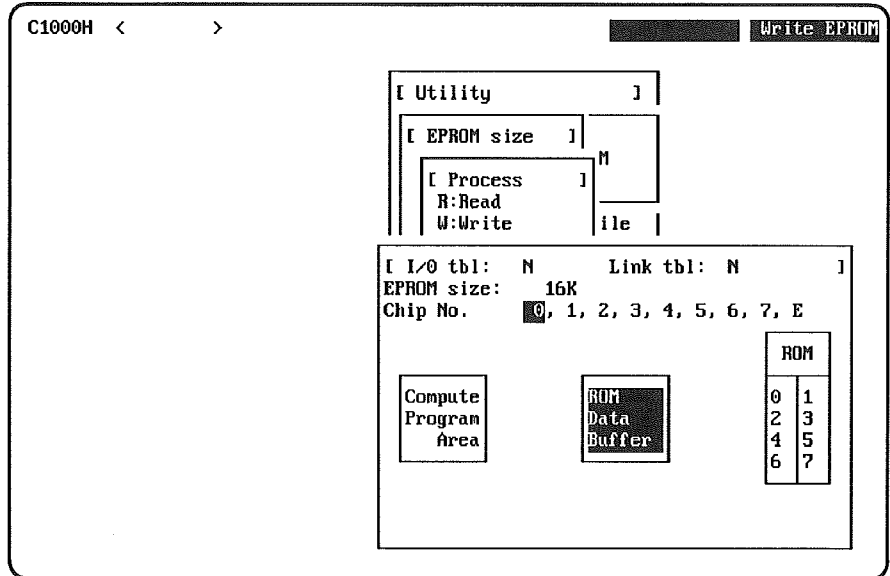

The program will be converted and transferred from the computer program area to the ROM data buffer while "Change" and the arrow will flash.

When the program has been converted, "Change" and the arrow will turn OFF and "ROM data buffer" will be highlighted.

7. Use the cursor and select the chip number. In this example, "0" is selected. The PROM will be checked to be sure it is blank, and then the write operation will start. "Write" and the arrow will flash. The number of addresses being written is counted and the status of the WRITE operation will be displayed as a percentage.

If the PC model is set to C200H in the System Setup, a fixed DM menu will be displayed. Specify whether the system work area's fixed DM range is to be overwritten by the ROM's fixed data.

If the System Setup is set to transfer the I/O table and data link table to the user's memory, a confirmation menu will appear before the following display appears.



The battery voltage detection setting will be transferred if designated in the System Setup.

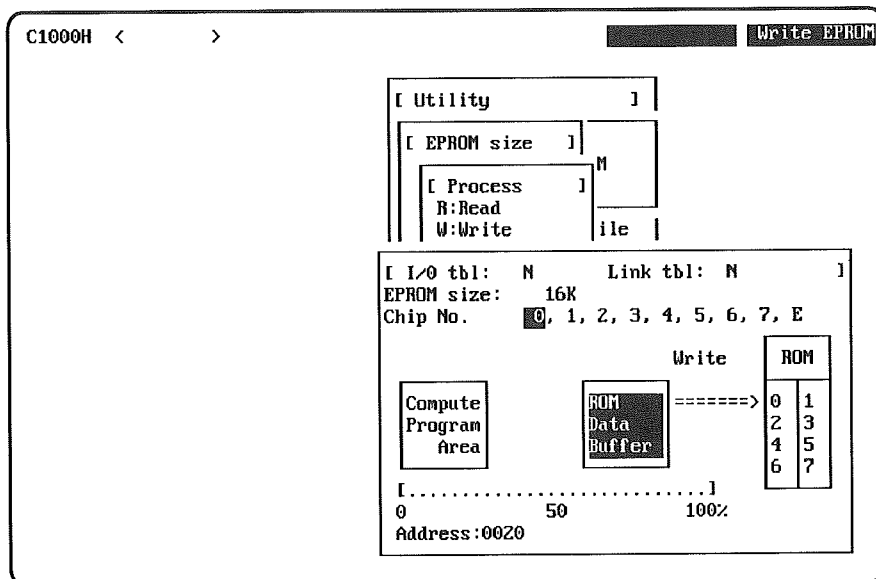

When the write operation finishes, the percentage display will indicate 100%.

8. Write the data in the PROM Writer buffer to the ROM chip according to the PROM Writer operating instructions.
9. Take the following steps to write the data to more than one ROM chip (on the C1000H/C2000H) without changing the screen.
  - a) Change the ROM chip.
  - b) Press the Right Cursor Key to select the chip number.
  - c) Press Enter.
  - d) Repeat steps 8. and 9. until data is written to all the ROM chips
10. After writing the data to the ROM chips, use the Right Cursor Key to select "E" and press Enter to finish the operation.

### 5-5-3 Reading from EPROM

This operation reads the program from the PROM Writer to the system work area.

#### READ

- 1, 2, 3...
  1. Insert the ROM chip to which a program has been written and follow the PROM Writer operating procedure to read the contents of the PROM to the buffer of the PROM Writer.
  2. Select "R:EPROM/Memory Card" from the Utility Menu.
  3. Select "T :Computer ↔ ROM."
  4. Specify the EPROM size. Refer to 5-5-1 Chip Selection and Chip Number Assignment for details on compatible ROM types. In this example, a ROM size of 16k bytes is selected.

| ROM chip | Size      |
|----------|-----------|
| 2764     | 8K bytes  |
| 27128    | 16K bytes |
| 27256    | 24K bytes |
| 27512    | 64K bytes |

5. Select "R:Read" from the Menu.

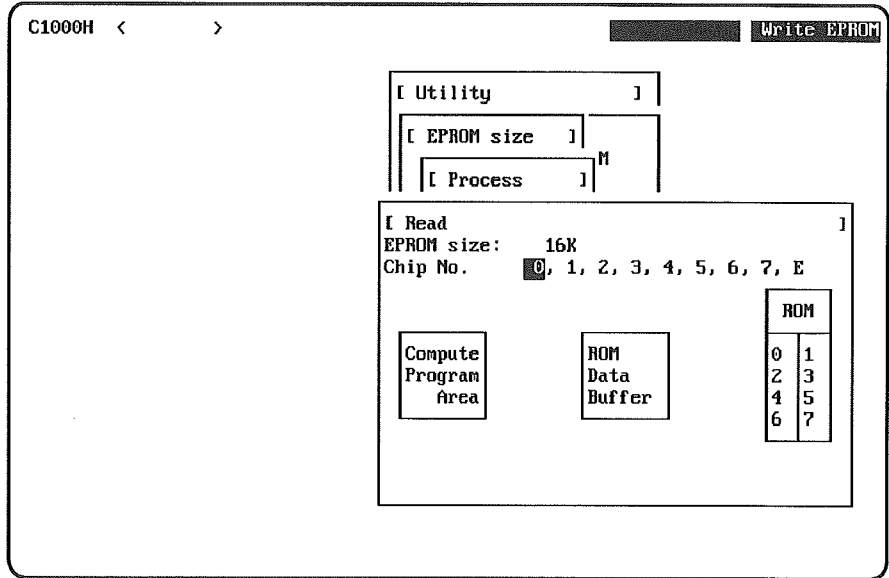

6. The operation cannot be cancelled once the chip number has been selected. If there are any programs in the system work area that should be saved, cancel the operation now, save the program, and start over.

Use the cursor to select the chip number. In this example, "0" is selected.

7. Data will be transferred from the PROM Writer, i.e., the program on ROM will be read to the ROM data buffer.

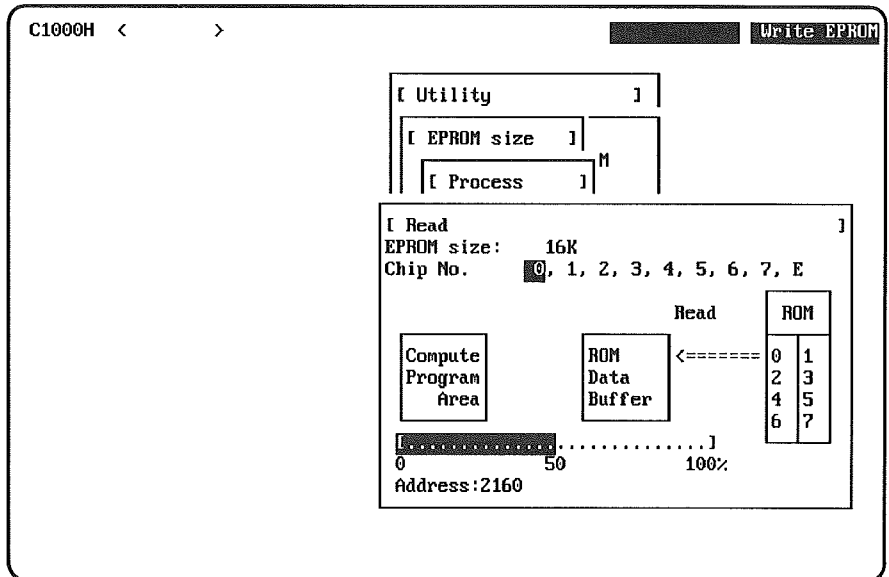

"Read" and the arrow will flash. The number of addresses being read will be counted and the status of the read operation will be displayed as a percentage. If there is an error during the operation, "Read error" will be displayed, and you will need to repeat the operation again. If a read error occurs again, replace the ROM chip.

When the read operation finishes, the percentage display will indicate 100% and "Verify" and the arrow will go OFF. The chip number from which the data was read to the ROM data buffer will be highlighted.

- If any data from the PROM Writer is in a format that can't be processed by SSS, the data transfer will be interrupted and an error message will be displayed.
- If the error message is displayed, press any key to return to the previous display.
8. Take the following steps to read from more than one ROM chip to the ROM data buffer without changing the display.
    - a) Refer to step 1. and replace the ROM chip.
    - b) Press the Right Cursor Key to select the chip number.
    - c) Press Enter.
  9. After reading all required data, use the Right Cursor Key to select "E" and press Enter. The contents of the ROM data buffer will be converted and written to the computer program area. "Change" and the arrow will flash.

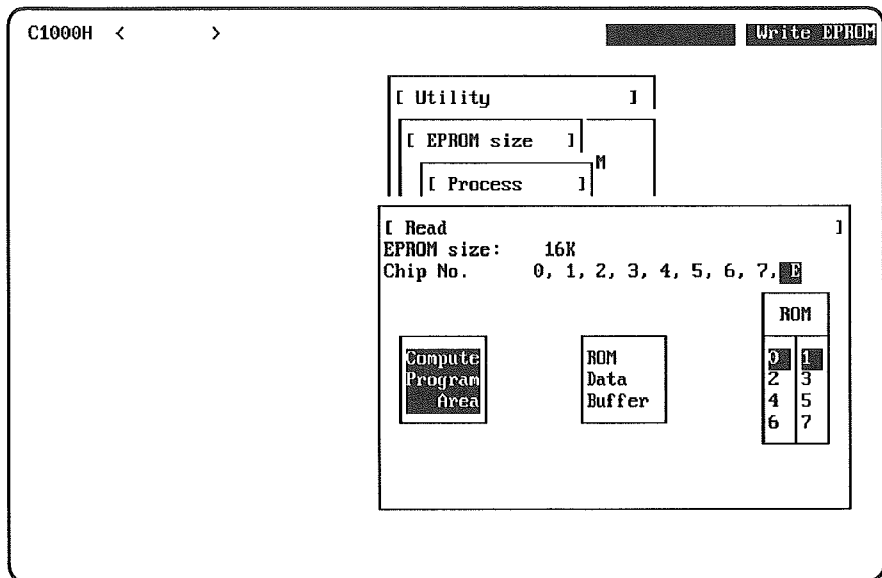

When the data has been converted, "Change" and the arrow will be OFF and "Compute program area" will be highlighted.

This operation cannot be aborted by pressing Escape or Ctrl + \ (or Shift + Escape). The C1000H and C2000H always handle ROM chips in pairs. Thus both the ROM chips must be read before finishing the read operation. The two ROM chips need not be read in numerical chip order.

If the I/O table and data link table are written to the PROM, a confirmation menu will appear before the above screen appears. Confirm if the I/O table and data link table in the system work area should be replaced with those in the PROM or not.

If the C200H is set in the System Setup, a display will appear prompting specification of the handling fixed DM area.

### 5-5-4 Verifying Programs on EPROM

This operation compares the program in the system work area to the one in ROM.

- 1, 2, 3...
  1. Insert a ROM chip in the PROM Writer and follow the PROM Writer operating procedure to read the contents of the PROM to the buffer of the PROM Writer.
  2. Select "R:EPROM/Memory Card" from the Utility Menu.
  3. Select "T:Computer ↔ ROM."

- Specify the EPROM size. Refer to 5-5-1 Chip Selection and Chip Number Assignment for details on compatible ROM types. In this example, a ROM size of 16k bytes is selected.

| ROM chip | Size      |
|----------|-----------|
| 2764     | 8K bytes  |
| 27128    | 16K bytes |
| 27256    | 24K bytes |
| 27512    | 64K bytes |

- Select "V :Verify" from the Menu. Program comparison will begin.

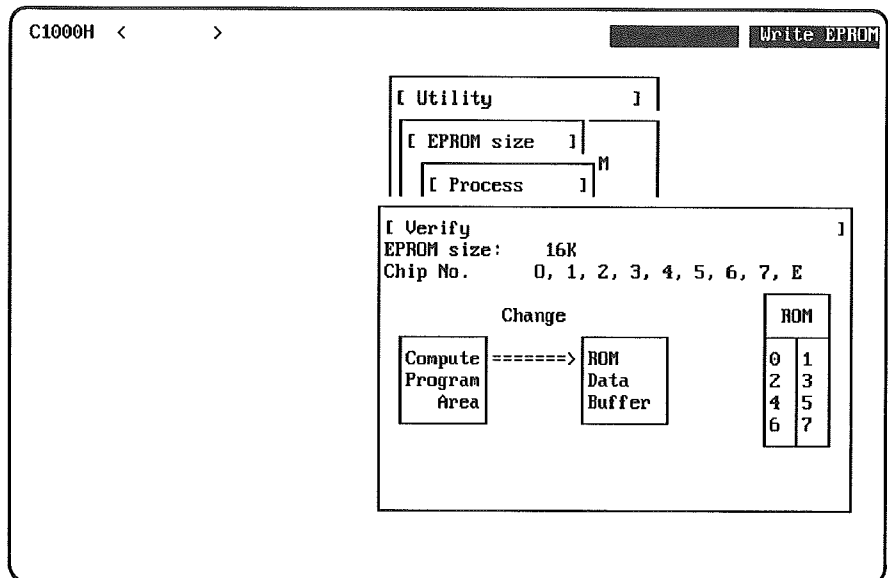

If the System Setup specifies transfer of the I/O table and data link table to the user memory, a confirmation display will appear before the above display appears. Confirm if the I/O table and data link table should be compared or not. The detection of battery voltage is verified as data. If these settings are different, a verify error will result.

If the PC model is set to C200H in the System Setup, a display will appear prompting for specification of the handling of the fixed DM area. Use the same specification as used when the ROM was written. The specification and the contents must be the same as what was written to the ROM.

The program will be changed and transferred from the computer program area to the ROM data buffer while "Change" and the arrow will flash.

After the program has been changed, "Change" and the arrow will turn OFF and "ROM data buffer" will be highlighted.

- Use the cursor and select the chip number. In this example, "0" is selected.

7. Data will be transmitted from the PROM Writer.

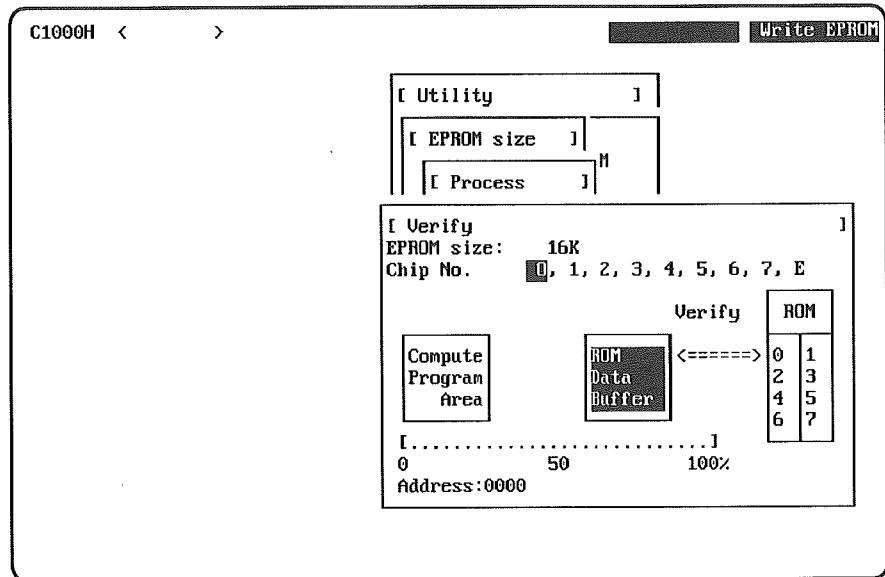

“Verify” and the arrow will flash. The number of addresses being verified will be counted and the status of the comparison operation will be displayed as a percentage.

When the comparison operation finishes, the percentage display will indicate 100% and “Verify” and the arrow will turn OFF.

If the contents of the ROM data buffer and those of the PROM Writer are different, “Verify error” will be displayed.

8. Take the following steps to verify the contents of more than one ROM chip (on the C1000H/C2000H) without changing the screen.
  - a) Refer to step 1. and replace the PROM.
  - b) Press the Right Cursor Key to select the chip number.
  - c) Press Enter.
9. After completing all the comparison operations, use the Right Cursor Key to select “E” and press Enter to finish the operation.

### 5-5-5 Intel HEX File

This operation converts the program in the system work area to a new Intel HEX file with the filename extension “.HEX.” The Intel HEX file can then be saved on a data disk or transferred to the PROM Writer. If the file is saved to a data disk, the disk should be formatted beforehand using the DOS command.

This section explains the procedures for creating HEX files and transferring those HEX files to the PROM Writer.

#### Creating an Intel HEX File

The procedure for creating HEX files is as follows:

- 1, 2, 3...
  1. Insert a blank EPROM chip in the PROM Writer.
  2. Select “R:EPROM/Memory Card” from the Utility Menu.
  3. Select “M:Intel HEX file” from the EPROM Functions Menu.

- Specify the EPROM size. Refer to 5-5-1 *Chip Selection and Chip Number Assignment* for details on compatible ROM types. In this example, a ROM size of 16k bytes is selected.

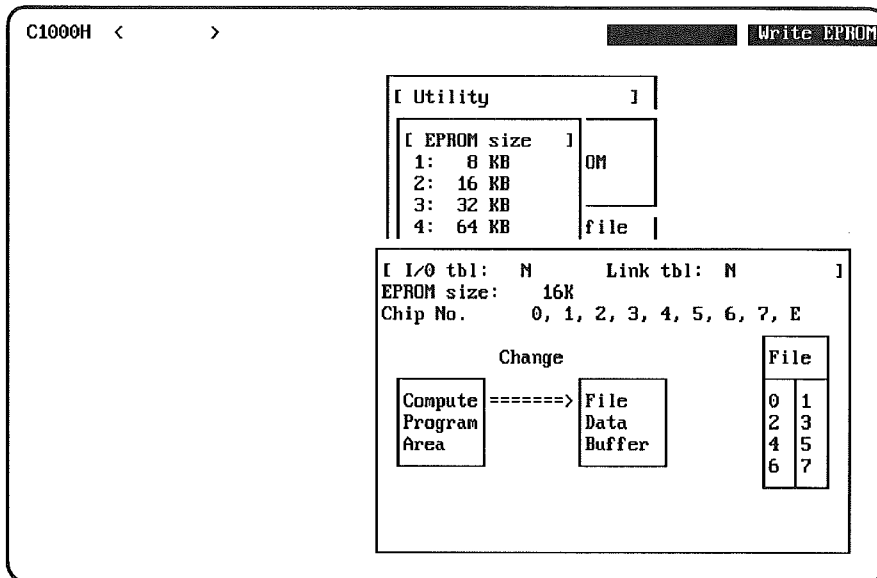

The program will be converted and transferred from the computer program area to the file data buffer while "Change" and the arrow will flash.

After the program has been changed, "Change" and the arrow will turn OFF and "File data buffer" will be highlighted.

- Use the cursor and select the chip number. In this example, "0" is selected.
- A prompt for the input of a file name input will appear on the bottom of the screen. Input an appropriate file name.

Up to 10 normal characters can be used for the file name. The file name can include the drive number, e.g., D:\ROM1601. If no drive number is input, the file will be created in the data drive designated in the System Setup. The file name will be given the extension ".HEX."

The ROM chip will be checked to verify that it is blank and the file will be written to the PROM Writer's data buffer.

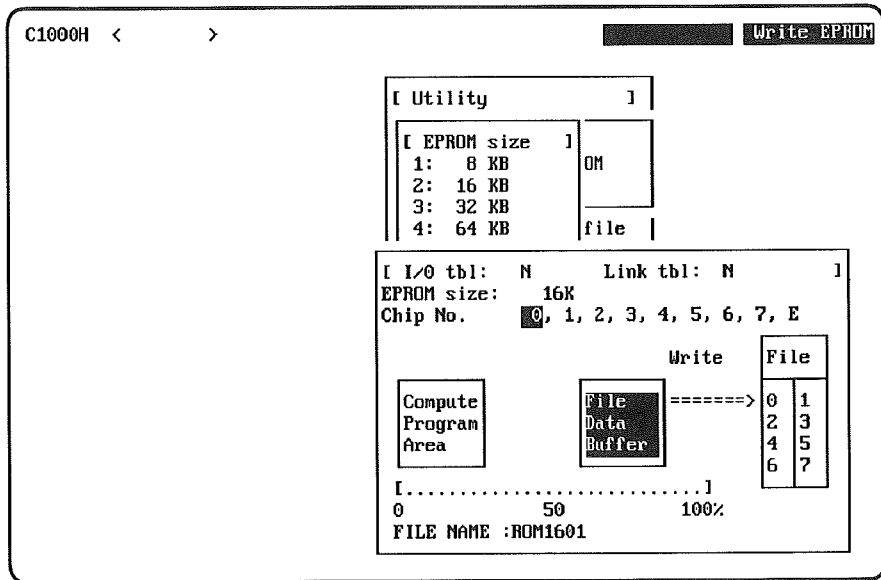

“Write” and the arrow will flash. The number of addresses being written will be counted and the status of the write operation will be displayed as a percentage. When the write operation finishes, the percentage display will indicate 100%.

7. Take the following steps to write the data to more than one Intel HEX file (for the C1000H/C2000H) without changing the display.
  - a) Press the Right Cursor Key to select the chip number.
  - b) Press Enter.
  - c) Repeat steps 6. and 7. until all data has been converted.
8. After writing all data to the Intel HEX files, use the Right Cursor Key to select “E” and press Enter to end the operation.

**Transferring Intel HEX Files**

An Intel HEX file that has been created can be transferred to the PROM Writer using the following DOS commands via an RS-232C port. Refer to your DOS user’s manual for the details.

## 5-6 Converting Programs

When the PC model in the System Setup is set for a C-series PC, a C500-family program can be converted to the C2000H-family program format.

When the PC model in the System Setup is set for a CV-series PC, a C2000H-family program can be converted to the CV-series program format.

### 5-6-1 C2000H → CVM1

This operation converts a C2000H-family program to a CV-series program. Refer to the *SSS Operation Manual: CVM1 PCs* for details.

### 5-6-2 C500 → C2000H

This operation converts a program on a data disk from the program format of the C500 family of PCs (C20, C50, P-type PCs, C120, and C500) to the program format of the C2000H family of PCs (C200H, C1000H, C2000H, Mini H-type PCs, K-type PCs, CQM1, and C200HS).

The program converted into the C2000H format is stored in the system work area’s program memory area. Therefore, if a program already exists, it will be erased when conversion is executed. The data disk’s contents will remain unaltered.

Only the IR and SR data areas are converted. The HR, LR, TIM/CNT and DM areas do not need to be converted and are therefore transferred to the system work area as they are. I/O comments, instruction comments, and block comments will be converted, with I/O comments moved to the new bit addresses.

The following figure shows the changes in operands when conversion is executed.

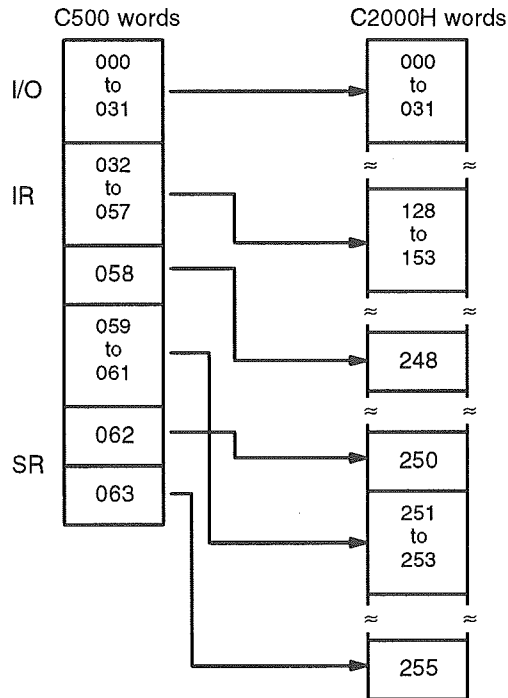

Conversion Example

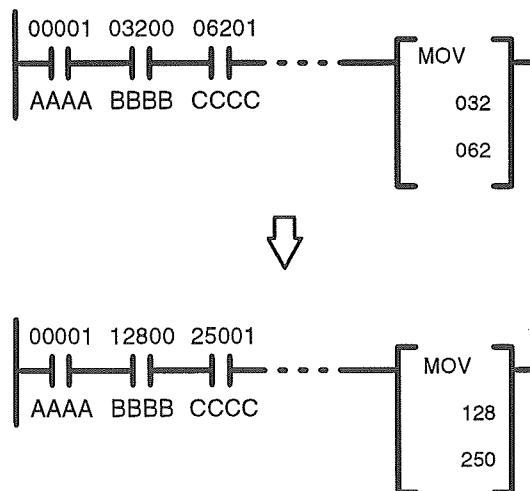



**Procedure** The procedure is as follows:

- 1, 2, 3... 1. Set the PC Model in the System Settings to C2000H.
2. Select "N:Program conversion" from the Utility Menu and press Enter.

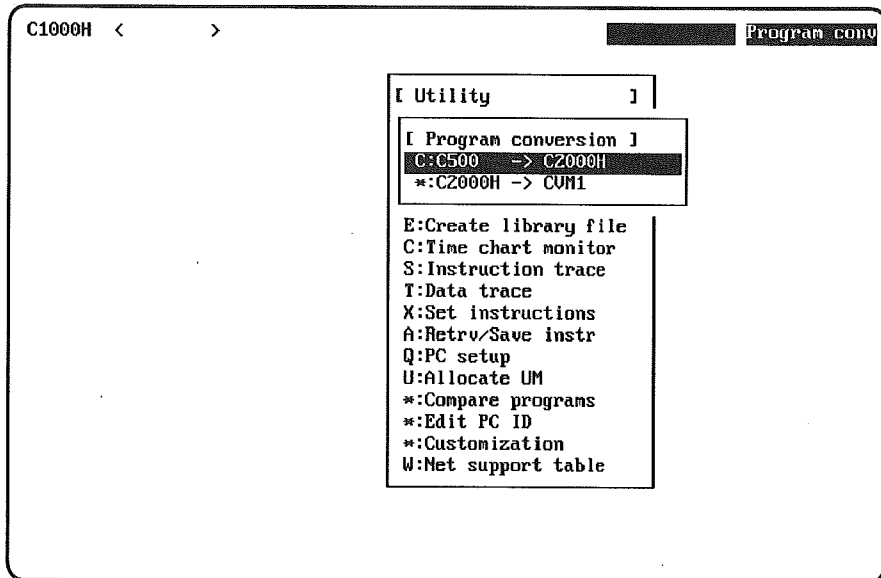

3. Select "C:C500 → C2000H" from the Menu and press Enter.
4. Insert the data disk storing a C500-format program into the data drive, enter the file name, and press Enter. A file name can also be selected from the directory. Press End, select the desired file and press Enter.  
The message "Converting" will be displayed until conversion is complete.
5. Press Escape to return to the Utility Menu.

If a disk formatted in the C2000H family has been inserted, the message "Wrong data disk" will be displayed. If instructions that cannot be converted are detected, the message "Cannot x n" will be displayed, with "n" indicating the number of instructions that cannot be converted. If these instructions are read, "???" will be displayed.

## 5-7 Creating LSS Data Libraries

This operation formats floppy disks for LSS file storage. Creating libraries is necessary if the data saved from the SSS is to be used later on the LSS. If the data is to be used only on the SSS or on the CVSS, then save the data in the default DOS format.

Floppy disks used to save DOS-format files can be formatted with the DOS FORMAT. Refer to your DOS user manuals for details.

**Caution** The Create Library File operations will erase all data from the specified floppy disk. Make sure that there isn't any required information on the disk.

Floppy disks can be 3.5" or 5.25", 2HD or 2DD. The 2HD disks have a storage capacity of 1.2 MB and 2DD disks have a storage capacity of 720 KB.

When a hard disk is used, a 1.2MB library is created in the current directory of the drive specified in the System Setup.

The following table shows the three data formats for LSS data disks. If the PC set in the System Setup isn't compatible with the data format of the data disk, files cannot be saved to or retrieved from the data disk.

| Data format | Applicable PCs   |
|-------------|--|
| C2000H      | The following PCs are compatible with the C2000H format:<br>Mini H-type, C200H, C1000H, C2000H, K-type, CQM1, and C200HS |
| C500        | The following PCs are compatible with the C500 format:<br>P-type, C20, C120, C500  |
| C2000H/C500 | All C-series PCs are compatible with the C2000H/C500 format.   |

The data that can be saved to or retrieved from the data disk includes the program, DM contents, I/O table, and data link table.

## 5-8 Time Chart Monitor Data

This operation is used 1) to display the time chart monitor data located in the system work area, 2) to save time chart monitor data from the system work area to a data disk, or 3) to retrieve time chart monitor data from a data disk to the system work area.

**Note** Time chart monitor data is generated by executing "Time chart monitor" in online operation.

- 1, 2, 3... 1. Select "C:Time chart monitor" from the Utility Menu.

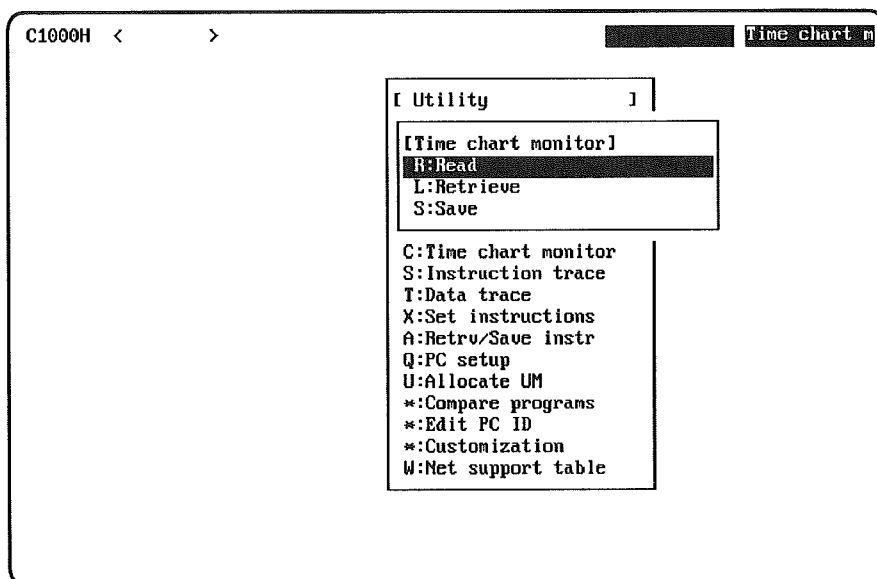

2. Select the desired operation.

The rest of the procedure is identical to that of the online operation. Refer to page 323 in *Part 3: Online Operation* for details.

## 5-9 Instruction Trace Data

This operation is used 1) to display the instruction trace data located in the system work area, 2) to save instruction trace data from the system work area to a data disk, or 3) to retrieve instruction trace data from a data disk to the system work area. This operation is supported for the C1000H and C2000H only.

**Note** Instruction trace data is generated by executing "Instruction trace" in online operation.

- 1, 2, 3... 1. Select "S:Instruction trace" from the Utility Menu.

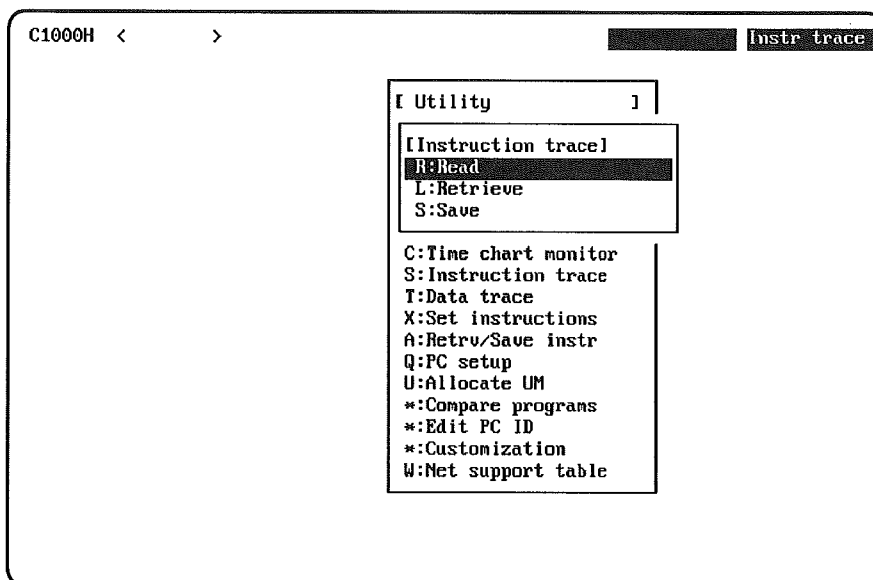

2. Select the desired operation.

The rest of the procedure is identical to that of the online operation. Refer to page 327 in *Part 3: Online Operation* for details.

## 5-10 Data Trace Data

This operation is used 1) to display the data trace data located in the system work area, 2) to save data trace data from the system work area to a data disk, or 3) to retrieve data trace data from a data disk to the system work area. This operation is supported for the C1000H, C2000H, CQM1 (CPU41 on), and C200HS only.

**Note** Data trace data is generated by executing "Data trace" in online mode.

- 1, 2, 3... 1. Select "T:Data trace" from the Utility Menu.

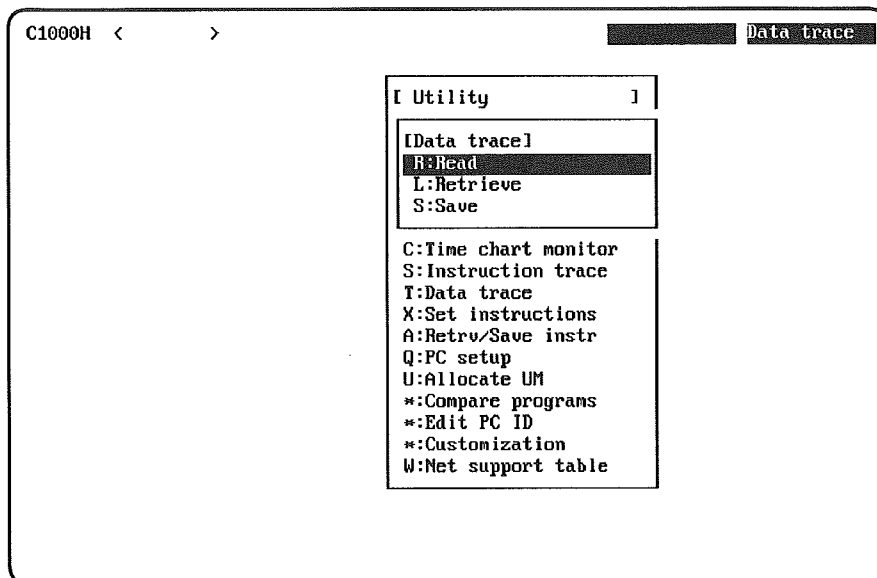

2. Select the desired operation.

The rest of the procedure is identical to that of the online operation. Refer to page 330 in *Part 3: Online Operation* for details.

## 5-11 Instructions Tables

The Set Instructions operation is used to assign expansion instructions to unused function codes so that expansion instructions can be used in programming. Only the CQM1, C200HS, and C200HX/C200HG/C200HE support instructions tables and expansion instructions. The Set Instructions operation can also be used to retrieve and save instructions tables from and to data disk files.

The instructions available for assignment to function codes are called expansion instructions; the table that is used to assign function codes to these instructions is called the instructions table. Both the entire list of expansion instructions and the instructions tables can be saved to disk. Expansion instructions can also be transferred to and from the PC (see *Part 3: Online Operation* for details).

There are a total of 18 function codes not used on the SSS. You can change the default instructions for one or all of these function codes.

**Note** The instruction tables differ for the CQM1 and the C200HS, C200HX/C200HG/C200HE but are automatically changed with the PC set in the System Setup is changed.

The following diagram shows expansion instruction assignment via the instructions table.

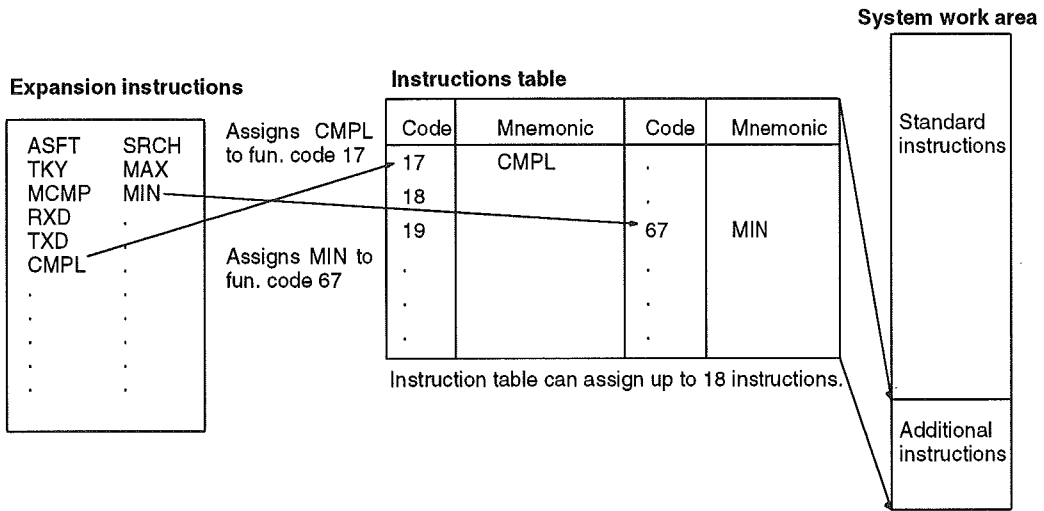

The Set Instructions Menu includes the following three operations.

| Operation               | Application   |
|-------------------------|---|
| E:Edit instructions     | Used to edit the instructions table and thus assign instructions to function codes. |
| L:Retrieve instructions | Retrieves an instruction table from a data disk file to the system work area.       |
| S:Save instructions     | Saves the instruction table in the system work area to a data disk file.            |

**Note** "Save Instructions" and "Retrieve Instructions" under the Set Instruction Menu are used to save and retrieve instructions tables to/from data disks. Refer to 5-12 *Expansion Instructions* for procedures on saving and retrieving expansion instructions.

### 5-11-1 Editing Instructions Tables

Use the following procedure to edit the instructions table in the system work area.

- 1, 2, 3... 1. Select "X:Set instruction" from the Utility Menu.

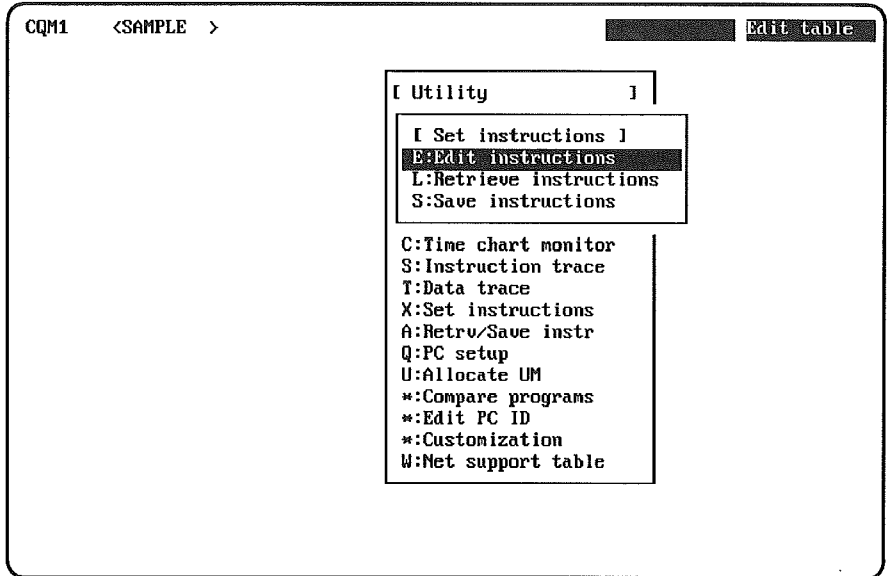

2. Select "E:Edit instructions" and press Enter.

The instructions presently set in the instruction table will be displayed.

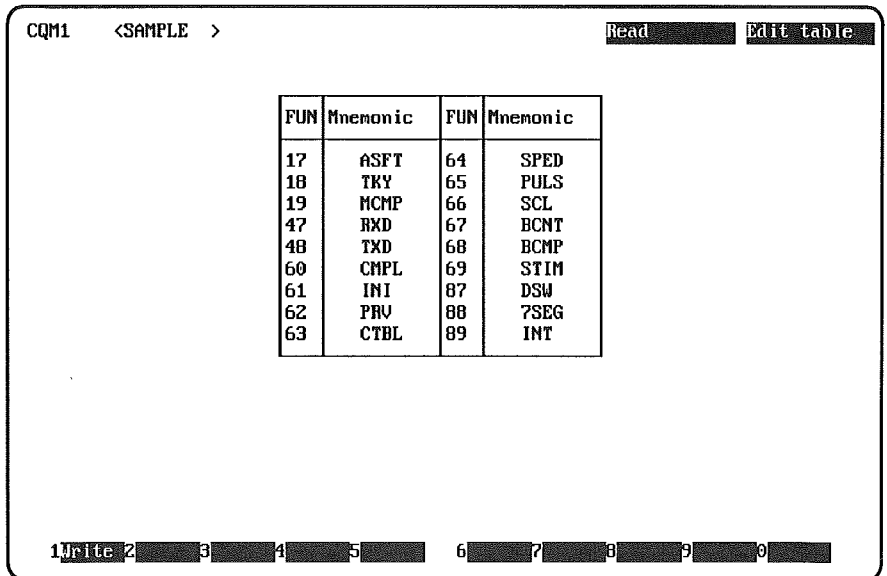

3. Press F1 (the Write Key) to go to the write mode.

An input area will appear.

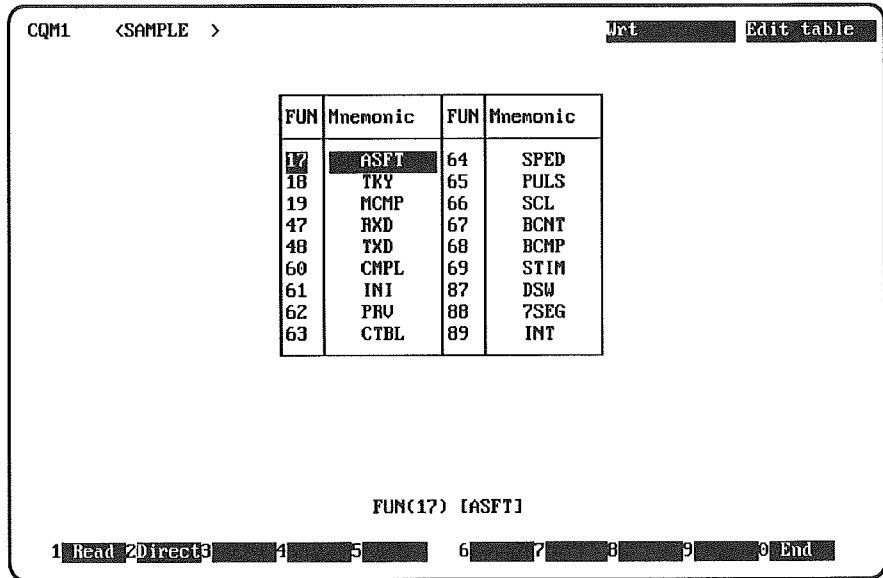

4. Input the mnemonic of the new instruction to be allocated and press Enter.
  - For example, to change ASFT to SRCH, type SRCH and press Enter.
  - If the instruction that has been input does not exist or the instruction has been input in lowercase letters, SV error will be displayed.
- or To use a list of expansion instructions to input the new instruction, move the cursor to the function code to be changed and press F2. A list will be displayed. Move the cursor to the instructions to be assigned, and press Enter. The instructions table will return with the new instruction specified in the input area.
  - Note** a) Even if the user selects an instruction that is already assigned in the instructions table, the instruction will be written, but an error will result when the user finishes processing.
  - b) Only instructions in the expansion instruction set can be assigned to function codes in the instructions table. Refer to 5-12 Expansion Instructions and to the Transfer Instructions operation in Part 3: On-line Operation for details on expansion instruction.
5. When all desired instructions have been assigned to function codes, press F10. The instructions table will be written to the system work area, and the screen will return to the read mode.

You can press the Escape Key to cancel editing the instruction table at any point up to writing the data to the system work area. A confirmation prompt will appear.

Input Y and Enter to cancel processing and return to the original instructions table. Press N and Enter to continue with the editing process.

### 5-11-2 Saving Instructions Tables

“Save Instructions” is used to save instructions tables from the system work area to data disk files.

**Note** When a program created for the CQM1, C200HS, or C200HX/C200HG/C200HE is saved to a data disk or a program on the data disk is retrieved for the CQM1, C200HS, or C200HX/C200HG/C200HE, the instructions table will be saved or retrieved as well. Retrieve Instructions and Save Instructions, however, make it possible to manage instructions tables separately from individual programs.

Use the following procedure to save the instruction table in the system work area to a file.

- 1, 2, 3... 1. Select "S:Save instructions" from the Set Instructions Menu. An input field for the file name will appear.

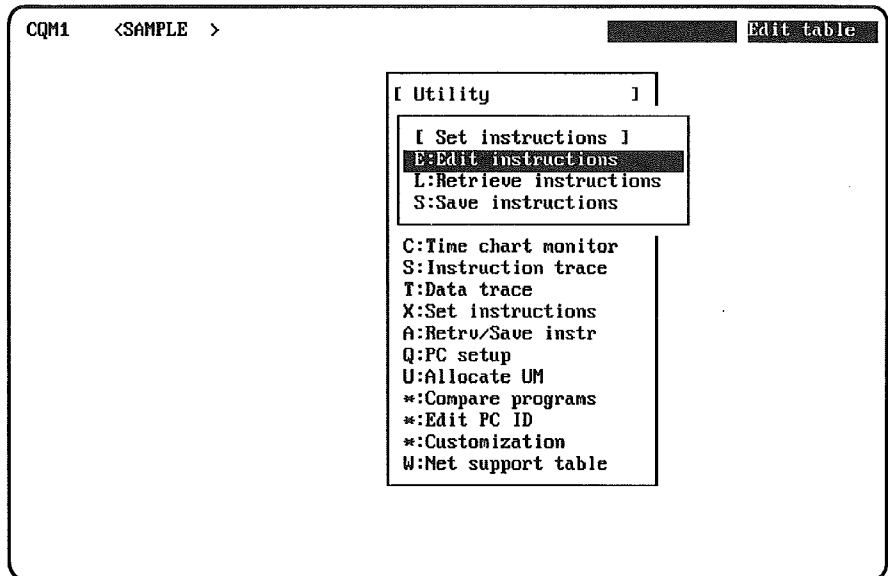

2. Enter the name of the file and press Enter. The End Key can be pressed to input the name from a directory list.

The instructions table in the system work area will be saved to the specified file and the menu will return.

### 5-11-3 Retrieving Instructions Tables

"Retrieve Instructions" is used to retrieve instructions tables from data disk files to the system work area.

**Note** When a program created for the CQM1, C200HS, or C200HX/C200HG/C200HE is saved to a data disk or a program on the data disk is retrieved for the CQM1, C200HS, or C200HX/C200HG/C200HE, the instructions table will be saved or retrieved as well. Retrieve Instructions and Save Instructions, however, make it possible to manage instructions tables separately from individual programs.

Use the following procedure to retrieve an instruction table from a data disk file to the system work area.



- 1, 2, 3... 1. Select "L:Retrieve instructions" from the Set Instructions Menu. An input field for the file name will appear.

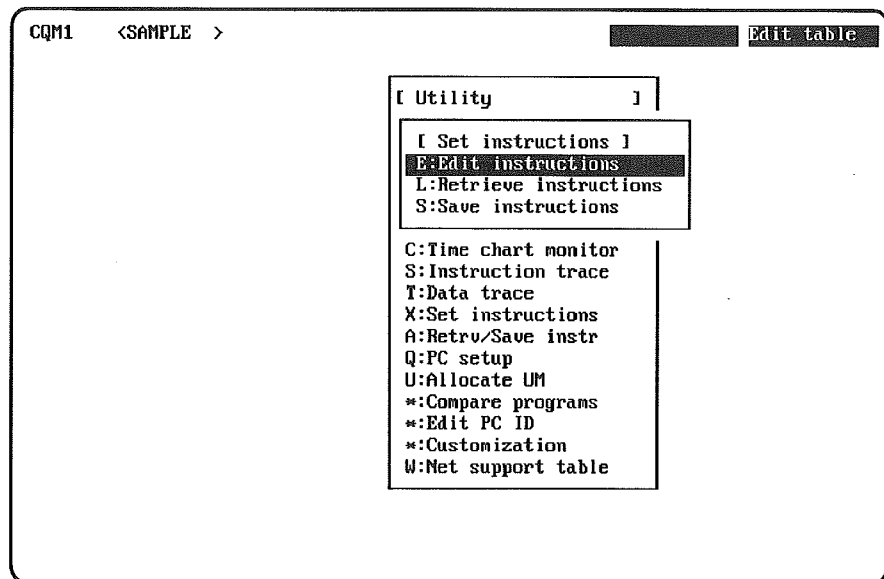

2. Enter the name of the file and press Enter. The End Key can be pressed to input the name from a directory list.

The instructions table will be retrieved from the specified file into the system work area and the menu will return.

## 5-12 Expansion Instructions

The Retrieve/Save Instructions operations are used to retrieve expansion instructions from data disk files to the system work area or to save expansion instructions from the system work area to data disk files.

The Transfer Instruction operations is used to transfer new instructions to the SSS when they have been added to the CQM1, C200HS, and/or C200HX/C200HG/C200HE in the future. This is an online operation.

Only the CQM1, C200HS, and C200HX/C200HG/C200HE support instructions tables and expansion instructions.

These commands can be used, for example, to copy expansion instruction sets to other peripheral devices.

The instructions in the expansion instruction set in the system work area will be displayed for the Set Instructions operation, as well as on the function code instructions list used during programming.

Use the following procedures to save/retrieve expansion instructions.

- 1, 2, 3... 1. Select "A:Retrv/Save instr" from the Utility Menu. The following menu will appear.

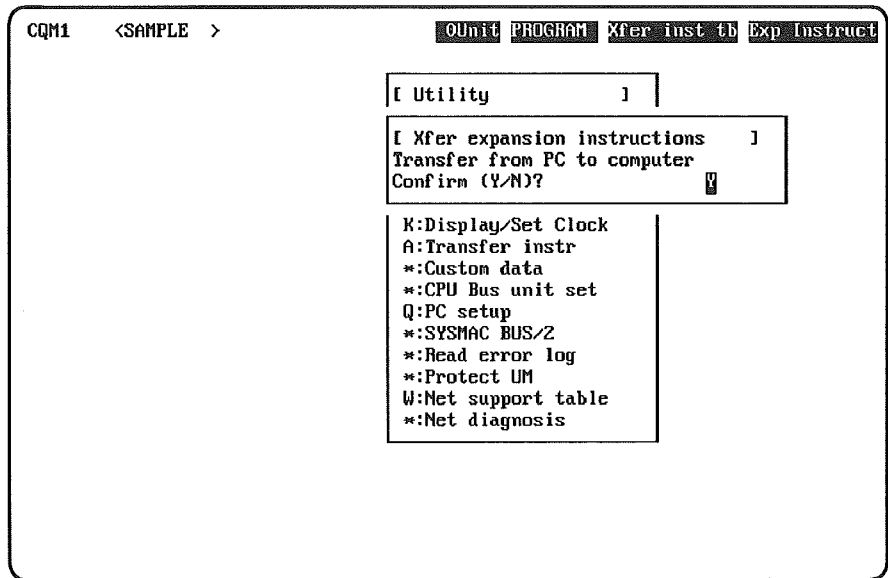

2. Continue to the Save Instructions or Retrieve Instructions procedure below.

### 5-12-1 Saving Expansion Instructions

Save Instructions is used to save expansion instruction sets from the system work area to data disk files.

- 1, 2, 3... 1. Select "S:Save instructions" from the Retrieve/Save Instructions Menu. An input field for the file name will appear.

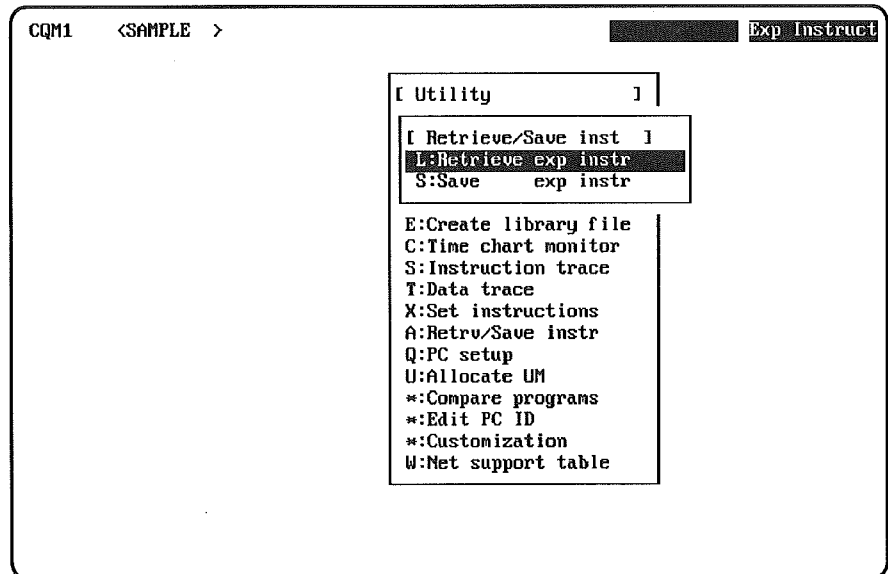

2. Enter the name of the file and press Enter. The End Key can be pressed to input the name from a directory list.

The expansion instruction set in the system work area will be saved to the specified file and the menu will return.

## 5-12-2 Retrieving Expansion Instructions

Retrieve Instructions is used to retrieve expansion instructions from data disk files to the system work area.

Use the following procedure to retrieve the expansion instructions from a data disk file to the system work area.

- 1, 2, 3... 1. Select "L:Retrieve instructions" from the Retrieve/Save Instructions Menu. An input field for the file name will appear.

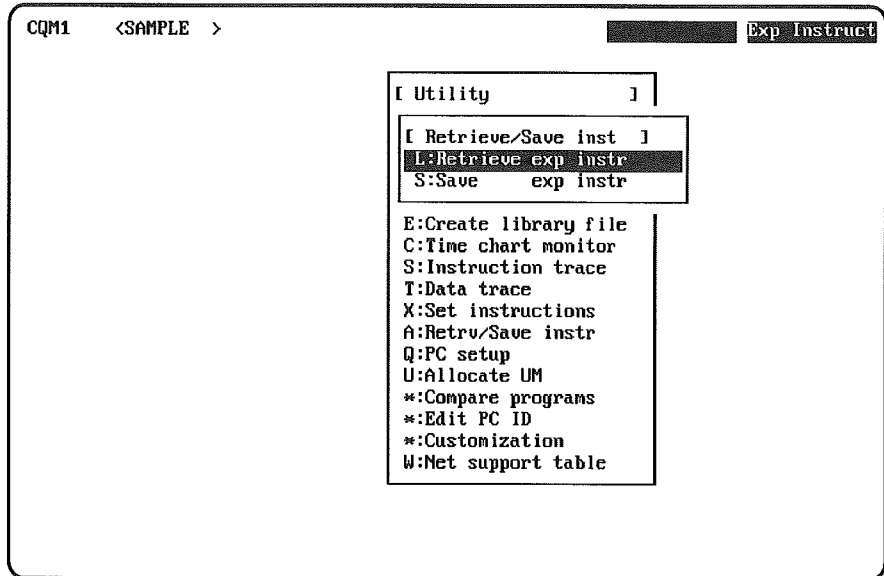

2. Enter the name of the file and press Enter. The End Key can be pressed to input the name from a directory list.

The expansion instruction set will be retrieved from the specified file into the system work area and the menu will return.

## 5-12-3 Transferring Expansion Instructions

Use the following operation to transfer expansion instructions from the CQM1, C200HS, or C200HX/C200HG/C200HE when new instructions have been added to them.

- 1, 2, 3... 1. Switch to online operation.
2. Select "A:Transfer instr" from the online Utility Menu. A confirmation display will appear.
3. Press Enter to transfer the expansion instructions supported by the PC connected to the SSS to the system work area.
- or Input "N" and press Enter to cancel the operation and return to the Utility Menu.

## 5-13 PC Setup

PC Setup can be used to change the PC operating parameters in the PC Setup in the system work area, to clear the PC Setup to default values, or to transfer the PC Setup to and from data disk files.

Online commands are available to edit the PC Setup in the PC directly or to transfer the PC Setup between the PC and the system work area.

The PC can be operated with the default PC Setup, which requires changing only when customizing the PC's operating environment to application needs.

The PC Setup is allocated to DM 6600 through DM 6655.

The PC Setup is supported by the CQM1 and the C200HS/C200HX/C200HG/C200HE only.

The following table summarizes offline PC Setup commands.

| Operation              | Application  |
|------------------------|--|
| P:Setup                | Used to set the parameters in the PC Setup in the system work area.          |
| S:Save to floppy       | Used to save the PC Setup in the system work area to a data disk file.       |
| L:Retrieve from floppy | Used to retrieve the PC Setup from a data disk file to the system work area. |
| C:Clear                | Used to clear the PC Setup in the system work area to its default settings.  |

### 5-13-1 Setting the PC Setup

Setup is used to set the PC operating parameters in the PC Setup in the system work area. These parameters are described in the following table.

| Parameter           | Default                         | Settings   | Remarks   |
|---------------------|---------------------------------|--|---|
| Startup mode        |                                 |  |   |
| Startup mode        | Programming Console mode switch | Programming Console mode switch, previous mode (i.e., the mode in use last time power was interrupted), PROGRAM, MONITOR, or RUN | Determines the operating mode the PC will start in when power is turned ON. This setting is required for restart continuation. Setting is effective from next time power is turned on to the PC.  |
| Forced status       | Don't hold                      | Hold or don't hold   | Determines whether or not the status of the Forced Status Hold Bit is maintained after power interruptions. If the status of the Forced Status Hold Bit is not set to be held, it will be turned OFF the next time the PC is started and forced status will be cleared. Setting is effective from next time power is turned on to the PC.   |
| IOM hold bit status | Don't hold                      | Hold or don't hold   | Determines whether or not the status of the IOM Hold Bit is maintained after power interruptions. If the status of the IOM Hold Bit is not set to be held, it will be turned OFF the next time the PC is started and I/O status will be cleared. This setting is required for restart continuation. Setting is effective from next time power is turned on to the PC.   |
| Cycle time          | Variable                        | Variable or minimum<br>Minimum setting: 1 to 9,999 ms  | Determines whether or not a minimum cycle time is to be used for user program execution. If a minimum time is set, the PC will wait until the minimum time has expired before starting program execution again. The entire program will be executed even if the minimum time is exceeded. This setting can be used to reduce variations in I/O response times. An error of approximately 3 to 4 ms, plus the execution time required for any interrupt programs, can occur. Setting is effective immediately. |

| Parameter            | Default   | Settings  | Remarks   |
|----------------------|---|---|---|
| Detect Long Cycles   | 120 ms  | 0 to 99,000 ms  | If the set time is exceeded, the Cycle Time Exceeded Flag will turn ON and a fatal error will occur.<br>An error of approximately 3 to 4 ms can occur.<br>Setting is effective immediately.   |
| <b>RS-232C setup</b> |   |   |   |
| Method               | Host link   | Host Link, RS-232C with no protocol, 1:1 link master, 1:1 link slave, NT Link (1:1), or NT Link (1:N) | Determines the settings used when a device, such as a Programmable Terminal or bar code reader is connected to the RS-232C port.<br>Do not set the node number to a number already used by another Unit connected in the same communications system (e.g., Host Link System). All other settings must match those of the device being communicated with.<br>Settings are effective immediately. |
| Node No.             | 0   | 00 to 31  |   |
| Delay                | 0   | 0 to 9,999 ms   |   |
| Start code           | None  | 00 to FF  |   |
| End code             | None  | 00 to FF or CR, LF  |   |
| Data link areas      | None  | LR 00 to LR 63, LR 00 to LR 31, or LR 00 to LR 15   |   |
| Baud rate            | 9,600 bps   | 1200, 2400, 4800, 9600, or 19200  |   |
| Stop bits            | 2 bits  | 1 or 2 bits   |   |
| Parity               | Even parity   | Even, odd, or none  |   |
| Data bits            | 7 bits  | 7 or 8 bits   |   |
| PT max unit No.      | 1   | 1 to 7  |   |
| PC Setup, HEX input  | Used to set the above parameters on a binary display. |   |   |

Use the following procedure to change the PC Setup.

- 1, 2, 3...** 1. Select "P:Setup" from the PC Setup menu. The following display will appear.

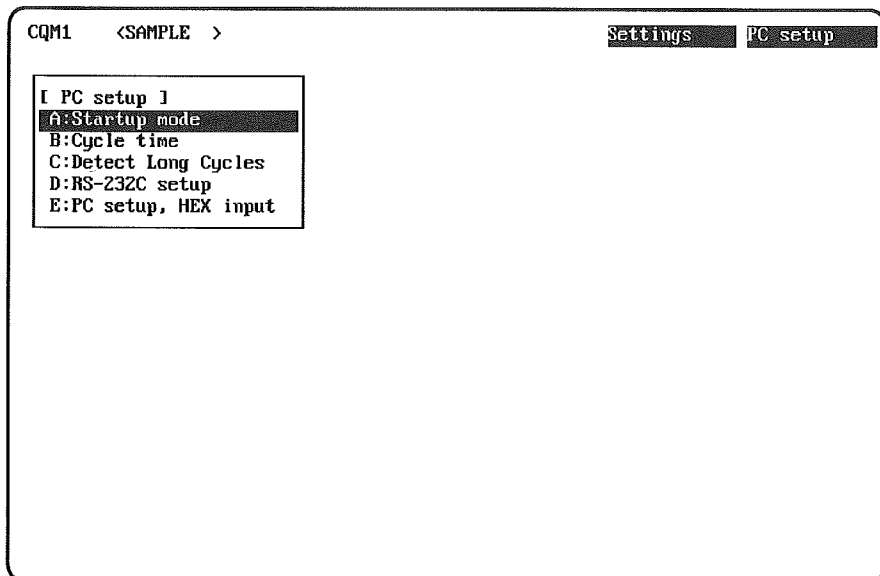

2. Select the item or area to be changed and continue with the following procedures (A through E).
3. Press the Escape Key to return to the PC Setup menu. If you have made changes to the PC Setup, a confirmation display will appear asking if the changes are to be saved.
4. Press Enter to save the changes.  
or Input N and Enter to cancel all changed made since the operation was entered.

**A:Startup Mode**

Use the following procedure to change the startup settings.

- 1, 2, 3... 1. Select "A:Startup mode" from the menu. The following display will appear with the current settings shown in parentheses.

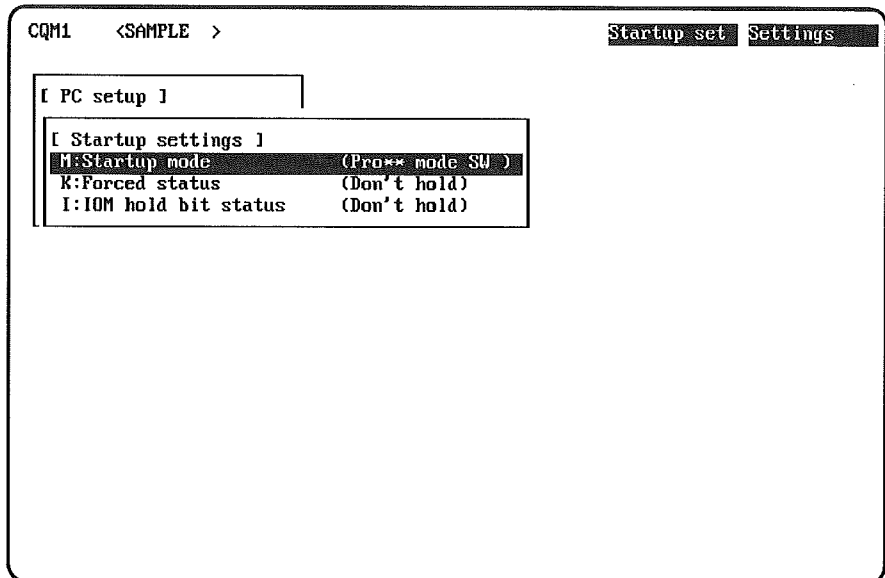

2. Select the item(s) to be changed and input the desired setting(s).

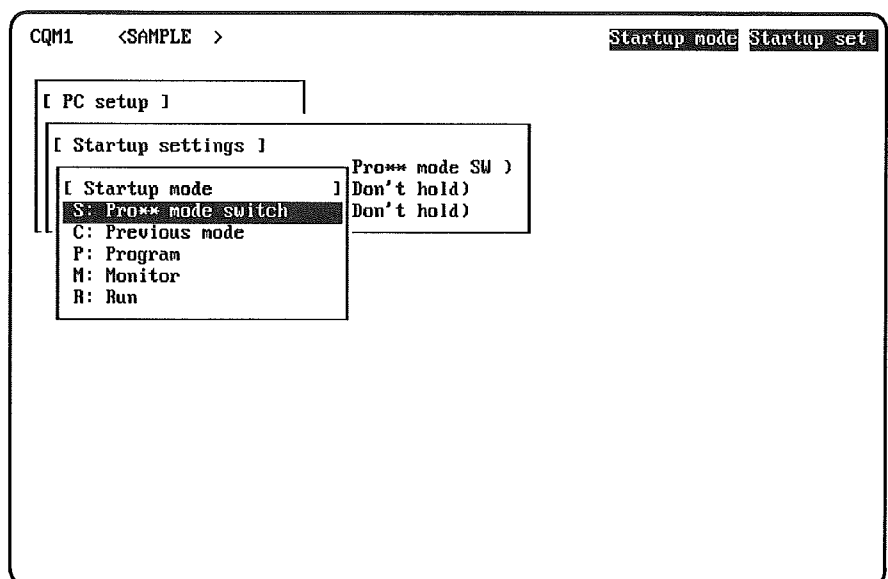

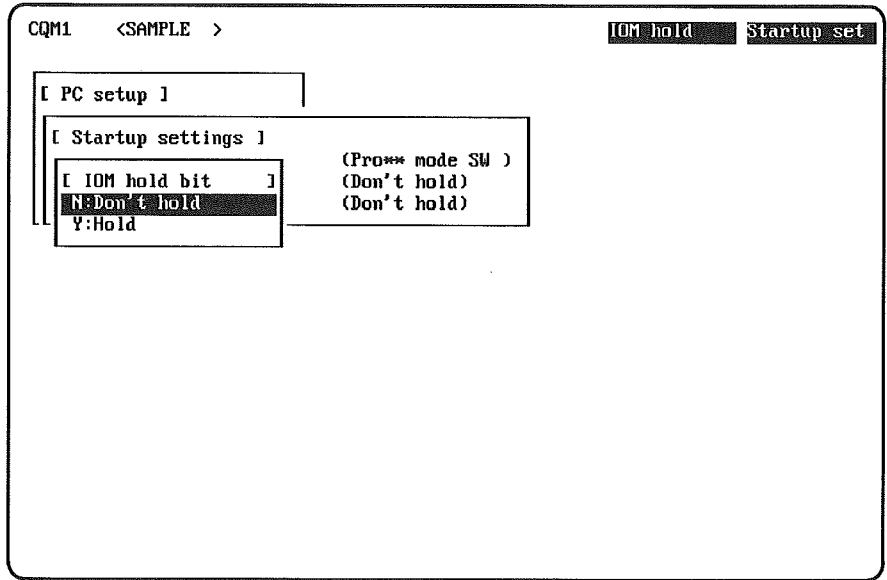
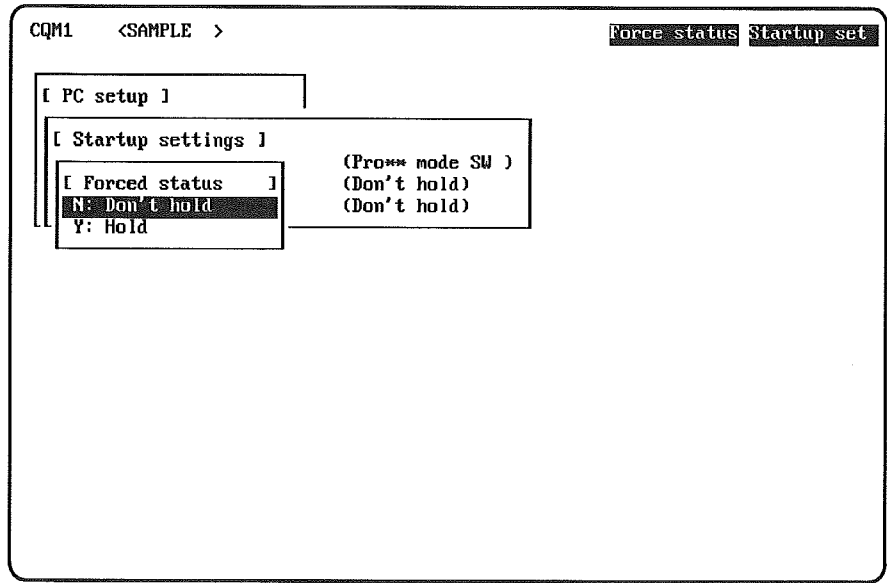

3. Press the Escape Key to return.

**B:Cycle Time**

Use the following procedure to set a variable or minimum cycle time.

- 1, 2, 3... 1. Select "B:Cycle time" from the menu. The following display will appear with the current setting shown in parentheses.

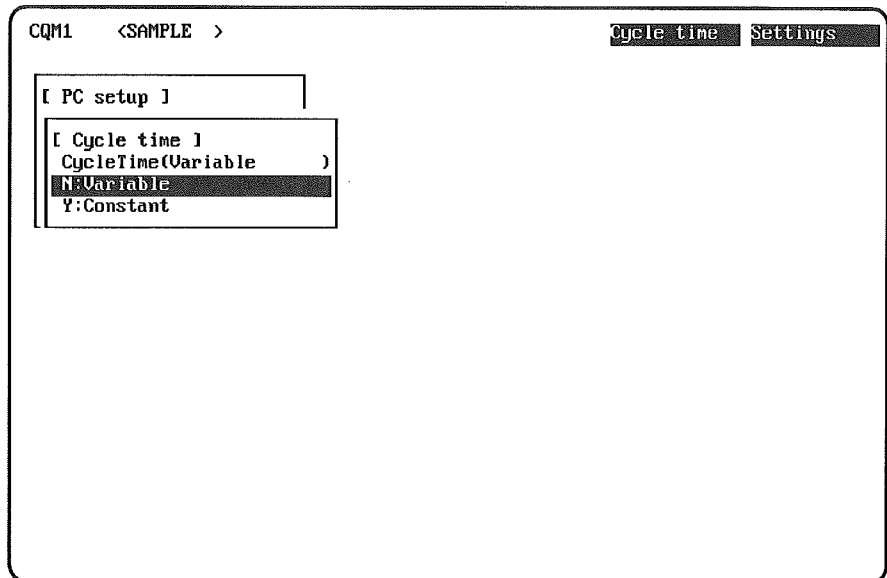

2. Select either a variable or minimum (Constant) cycle time. If a minimum cycle time is selected, the following display will appear.

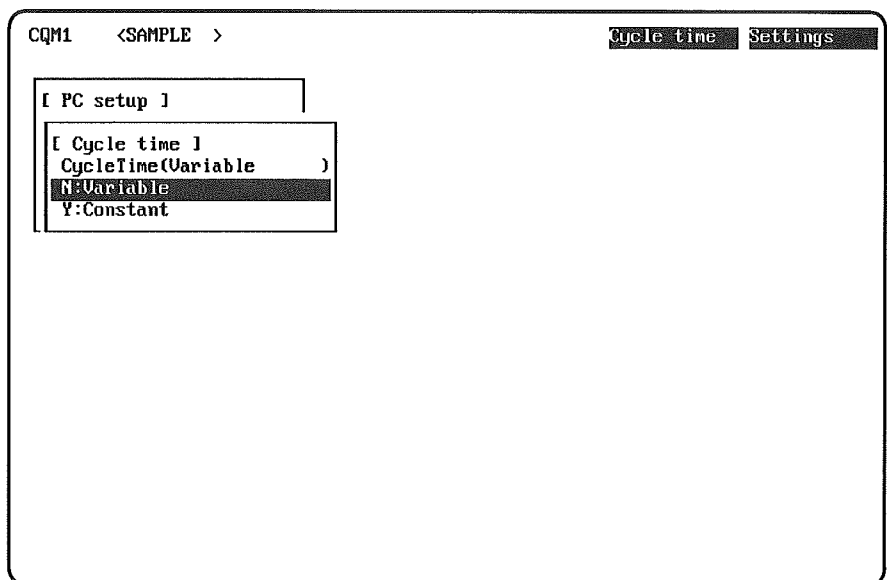

3. Input the desired minimum cycle time and press Enter.



**C:Detect Long Cycles**

Use the following procedure to set a time limit for the cycle time.

- 1, 2, 3... 1. Select "C:Detect Long Cycles" from the menu. The following display will appear with the current setting shown.

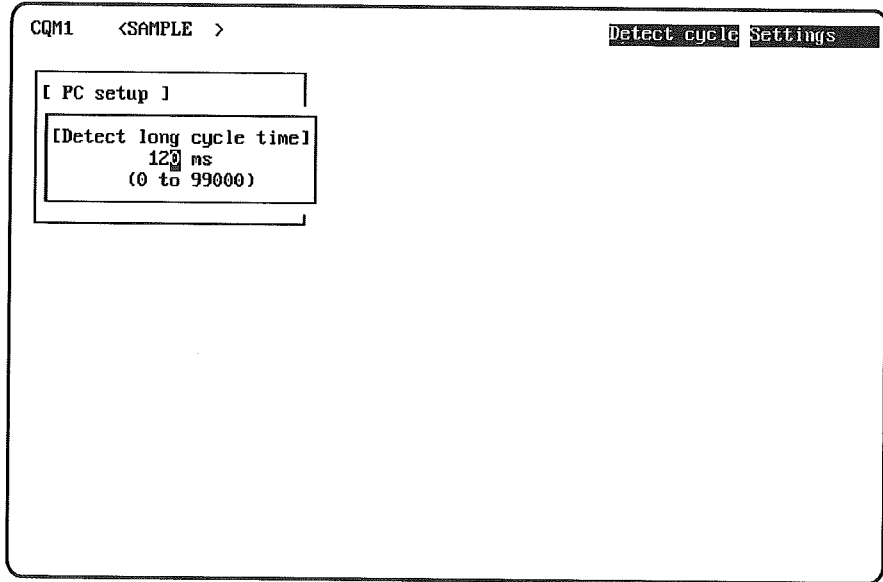

2. Input the desired limit for the cycle time and press return.  
 The cycle monitor time is input in different units depending on the range, as shown below:  
 0 to 990 ms: Input in increments of 10 ms  
 1000 to 9900 ms: Input in increments of 100 ms  
 10000 to 99000 ms: Input in increments of 1000 ms ( 1 s ).

**D:RS-232C Setup**

Use the following procedure to change the RS-232C setup.

- 1, 2, 3... 1. Select "D:RS-232C setup" from the menu. The following display will appear with the current settings shown in parentheses.

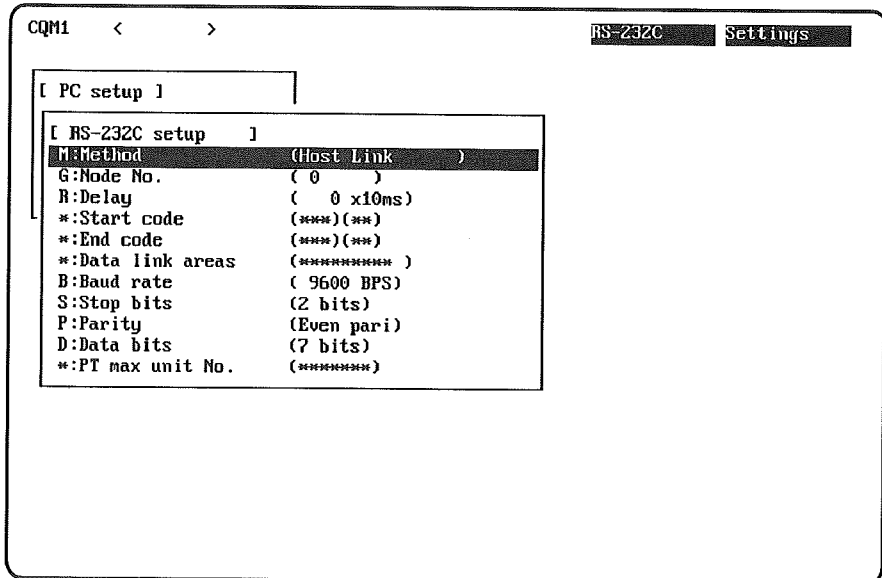

2. Select the item(s) to be changed and input the desired setting(s).

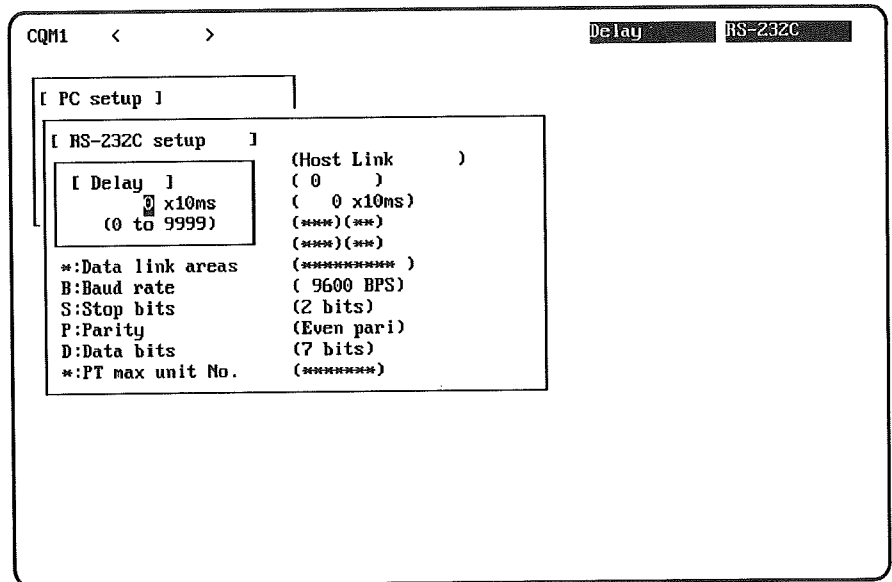
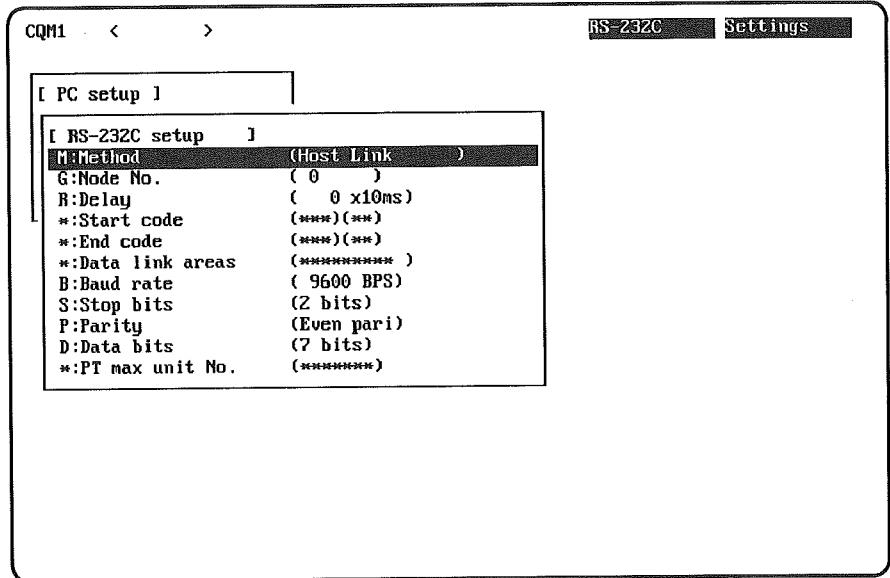

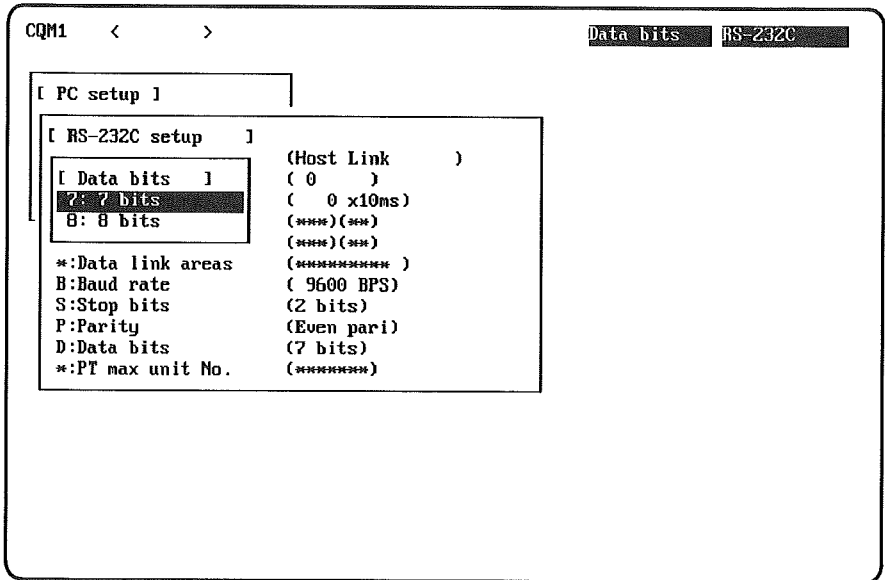
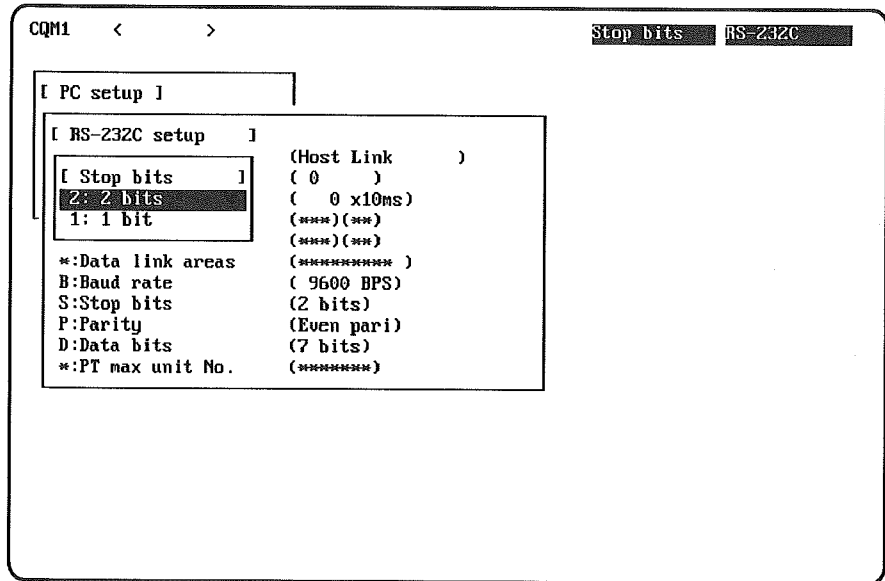

CQM1 < > Node number: RS-232C

[ PC setup ]

[ RS-232C setup ]

[ Unit No. ]

3 unit  
(0 to 31)

\*(Data link areas) (\*\*\*\*\* )  
 B:Baud rate ( 9600 BPS)  
 S:Stop bits (2 bits)  
 P:Parity (Even pari)  
 D:Data bits (7 bits)  
 \*:PT max unit No. (\*\*\*\*\*)

CQM1 < > Baud rate: RS-232C

[ PC setup ]

[ RS-232C setup ]

[ Baud rate ]

A:1200 BPS  
 B:2400 BPS  
 C:4800 BPS  
 D:9600 BPS  
 E:19.2K BPS

\*(Data link areas) (\*\*\*\*\* )  
 B:Baud rate ( 9600 BPS)  
 S:Stop bits (2 bits)  
 P:Parity (Even pari)  
 D:Data bits (7 bits)  
 \*:PT max unit No. (\*\*\*\*\*)

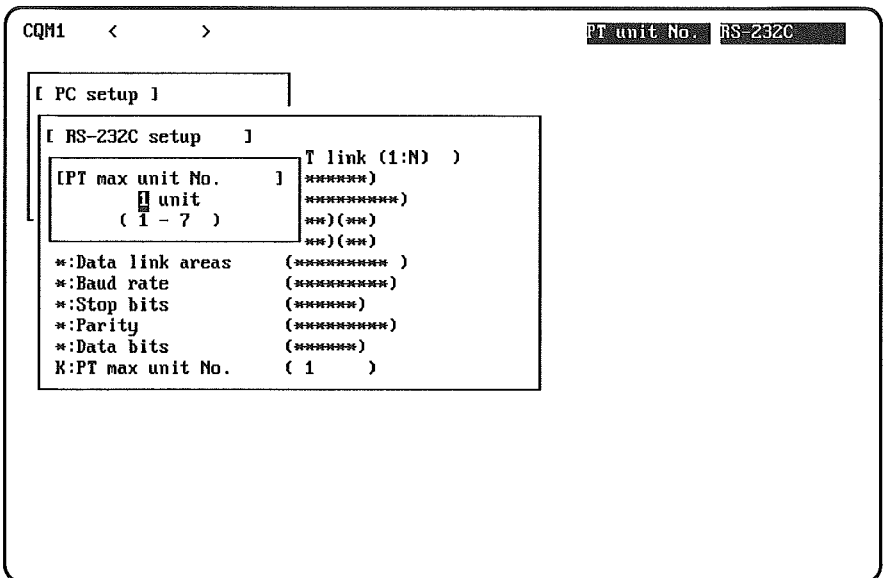
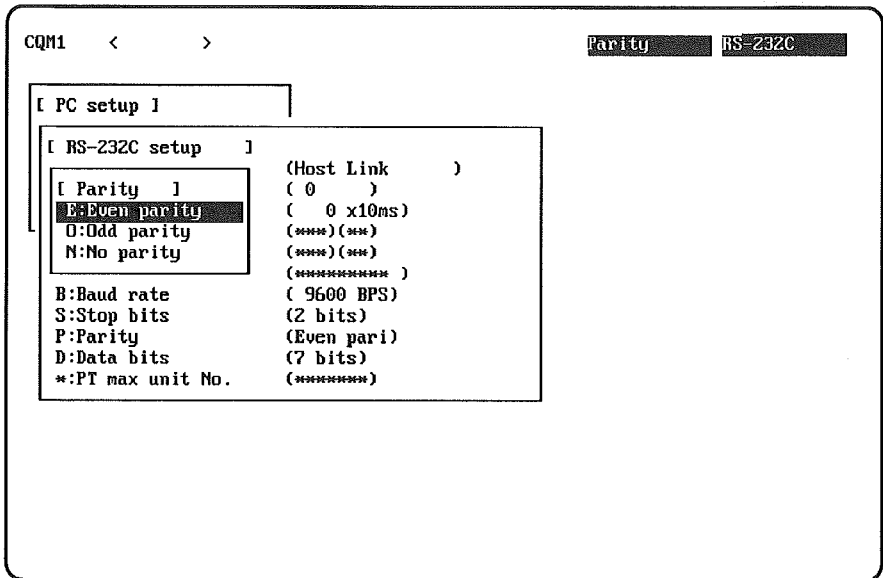

**E:PC Setup, HEX Input**

Use the following procedure to set the PC Setup on a binary display.

- 1, 2, 3... 1. Select "E:PC Setup, HEX input" from the menu. The following display will appear with the current settings shown as hexadecimal values in DM 6600 to DM 6655.

The display at the bottom of the screen will show the binary equivalent of the hexadecimal contents of the word at the cursor location.

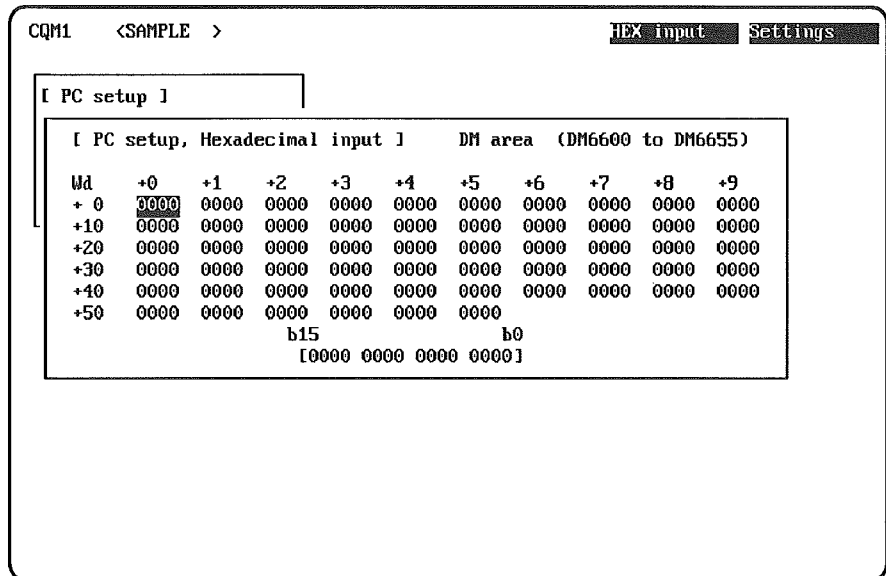

2. Move the cursor to the word to be changed and input the desired hexadecimal value.

**Note** Only hexadecimal values can be input; the binary value at the bottom of the screen is for display only.

3. When all desired data has been set, press Enter.

### 5-13-2 Saving PC Setup to Disk

"Save to floppy" is used to save the PC Setup from the system work area to data disk files.

**Note** "Save to floppy" is also used to save the PC Setup to the hard disk.

- 1, 2, 3... 1. Select "S: Save to floppy" from the PC Setup menu. An input field for the file name will appear.
2. Enter the name of the file. The End Key can be pressed to input the name from a directory list.  
When Enter is pressed, the PC setup in the system work area will be saved to the specified file and the menu will return. The file extension .Q will be used.

### 5-13-3 Retrieving PC Setup from Disk

"Retrieve from floppy" is used to retrieve a PC Setup from a data disk file to the system work area.

**Note** "Retrieve from floppy" is also used to retrieve the PC Setup from the hard disk.

- 1, 2, 3... 1. Select "L: Retrieve from floppy" from the PC Setup menu. An input field for the file name will appear.
2. Enter the name of the file. The End Key can be pressed to input the name from a directory list.  
When Enter is pressed, the PC Setup will be retrieved from the specified file into the system work area and the menu will return.

### 5-13-4 Clearing the PC Setup

"Clear" is used to return the settings of the parameters in the PC Setup in the system work area to their default settings. Use the following procedure.

- 1, 2, 3... 1. Select "C:Clear" from the PC Setup menu. The following confirmation display will appear.

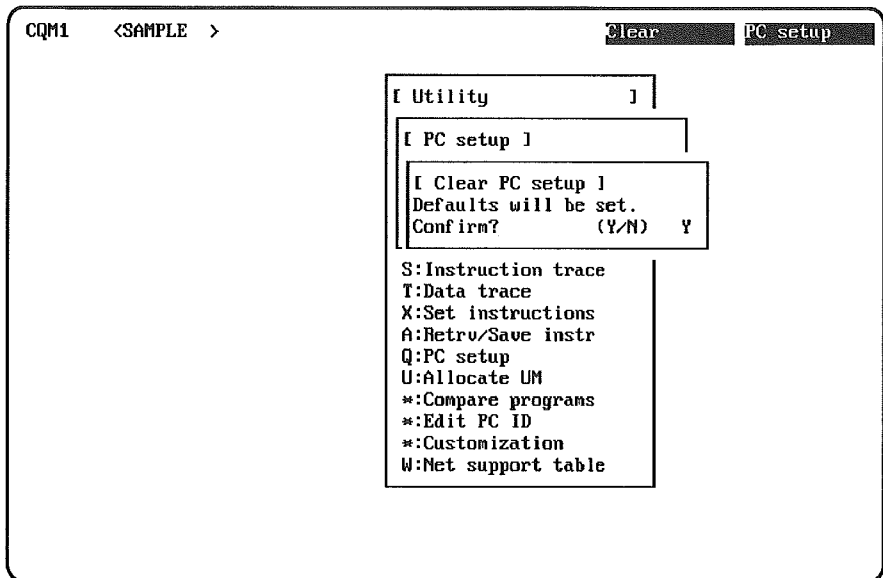

2. Enter "Y" to clear the PC Setup to its default settings.  
 or Enter "N" to cancel the operation and return to the PC Setup menu without changing the PC Setup.

### 5-13-5 Transferring the PC Setup

There are two operations on the online Utility Menu used to transfer the PC Setup between the PC and the SSS. These operations are supported by the CQM1, C200HS, and C200HX/C200HG/C200HE only. Generally, parameters set in the PC Setup during offline operations are transferred to a PC.

Use the following procedure.

- 1, 2, 3... 1. Change to online operation.  
 2. Select "Q:PC setup" from the online Utility Menu. The PC Setup Menu will be displayed.  
 3. Select "P:Setup" to edit the PC Setup in the PC, select "R:PC → Computer" to transfer the PC Setup in the PC to the SSS, and select "W:Computer → PC" to transfer the PC Setup in the SSS to the PC.  
 4. When the transfer has been completed, the online Utility Menu will return.

## 5-14 Allocating UM

The Allocate UM operation allows the user to allocate portions of the C200HS, C200HX/C200HG/C200HE user program area to store fixed DM area data and I/O comments. These areas are called, respectively, the expansion DM area and the I/O comment area. By default, the entire UM area is allocated to the ladder program.

UM allocation is supported by the C200HS, C200HX/C200HG/C200HE only.

**Note** Allocating UM area for an expansion DM and/or I/O Comment Area will reduce program capacity. Check program capacity requirements before allocating the UM area.

**C200HS,  
 C200HX/  
 C200HG/  
 C200HE DM  
 and UM Areas**

The C200HS, C200HX/C200HG/C200HE provides a UM area that contains the fixed DM area and the ladder program area. Using the Allocate UM operation, portions of the ladder program area can be allocated as 1) an expansion area for the fixed DM

area and/or 2) storage of I/O comments. The structure of the C200HS, C200HX/C200HG/C200HE DM and UM areas is shown in the following illustration.

- Note**
1. With the C200HS, C200HX/C200HG/C200HE, the UM area is defined as the part memory that can be converted and transferred to ROM.
  2. The capacity of the ladder program area varies with the PC.

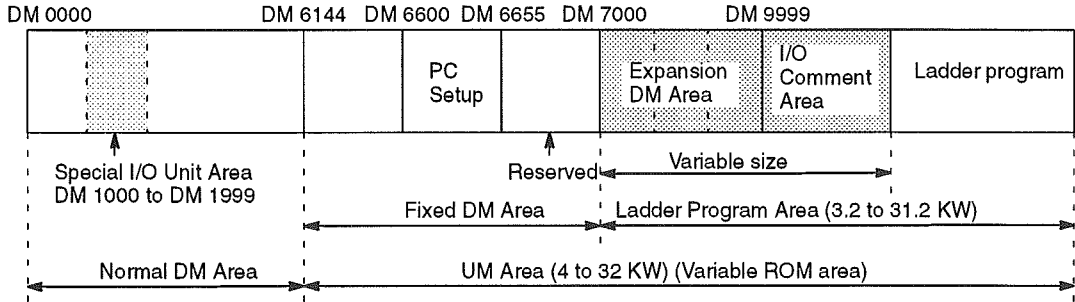

**Expansion DM Area** The expansion DM area is designed to provide memory space for storing operating parameters and other operating data for Link Units and Special I/O Units. Expansion DM area addresses run from DM 7000 to DM 9999 and are allocated in the UM area. The data in the expansion DM area can be transferred to the Special I/O Unit Area (DM 1000 to DM 1999) when starting the PC or via programming instruction to easily change operating parameters, enabling rapid switching between control processes. The expansion DM area can also be used to store parameters for other devices connected in the PC system, e.g., Programmable Terminal character string or numeral tables.

The expansion DM area is used to store operating parameters and cannot be used in programming like the normal DM area.

The UM area can be allocated as expansion DM area in increments of 1K words. The four possible settings are shown in the following table. Once expansion DM area has been created, it is saved and transfer as part of the program, i.e., no special procedures are required when saving or transferring the program.

| Set capacity | Expansion DM addresses |
|--------------|------------------------|
| 0 KW         | None                   |
| 1 KW         | DM 7000 to DM 7999     |
| 2 KW         | DM 7000 to DM 8999     |
| 3 KW         | DM 7000 to DM 9999     |

**I/O Comment Area** Allocating part of the UM area to I/O comments enables transferring the program and I/O comments together to simplify program management and to allow for easier troubleshooting.

The UM area can be allocated as I/O comment area in increments of 1K words. The seven possible settings are shown in the following table (the numbers of comments are only approximations given here for reference). Once an I/O comments area has been created, it is saved and transfer as part of the program, i.e., no special procedures are required when saving or transferring the program.



| Set capacity | Number of comments |
|--------------|--------------------|
| 0 KW         | None               |
| 1 KW         | 113                |
| 2 KW         | 227                |
| 3 KW         | 341                |
| 4 KW         | 455                |
| 8 KW         | 910                |
| 16 KW        | 1,820              |
| 20 KW        | 2,257              |
| 25 KW        | 2,894              |
| 31 KW        | 3,527              |

**Note** The largest memory capacity available is 16 KW as of this publication. Allocating 16 KW to the I/O comment area will therefore leave no room for a user program.

**ROM Conversion**

The UM area, including the program as well as the expansion DM and I/O comment areas, can be converted and stored on ROM.

**Note** The following tables list the DM address ranges that can be transferred when transferring data to and from the C200HS, C200HX/C200HG/C200HE. The words that are transferred depend on the allocation of the UM area.

**Ranges Possible when Transferring DM Data**

| Expansion DM Area allocated using Allocate UM | Words transferred from SSS to PC  | Words transferred from PC to SSS |
|---|---|----------------------------------|
| No  | DM 0000 to DM 6599  | DM 0000 to DM 6655               |
| Yes   | All DM words through all banks set for both the SSS and the PC, i.e., if the setting differ, only the banks for the one with the lower settings will be transferred.<br><br>Example:<br>If 2 KW are allocated to the Expansion DM Area, DM 0000 to DM 8999 will be transferred. |                                  |

**Ranges Possible when Transferring the PC Setup**

| Expansion DM Area allocated using Allocate UM | Words transferred from SSS to PC | Words transferred from PC to SSS |
|---|----------------------------------|----------------------------------|
| No  | DM 6600 to DM 6655               |                                  |
| Yes   |                                  |                                  |

**Program Save/Transfer**

The expansion DM and I/O comment areas are automatically saved with the program and are automatically transferred to the PC along with the program.

**Procedure**

Use to following procedure to allocate portions of the UM area as an expansion DM area and/or I/O comment area.

- 1, 2, 3... 1. Select "U:Allocate UM" from the Utility Menu. The following display will appear.

```

C200HS < > JM area

[ Utility ]

[ Allocate UM ]
Expansion DM      : 0KW (          )
I/O Comment area : 0KW (0-31KW) (Priority: IR,LR,HR,AR,T/C )
                  (Approx. 0 Comments )

Ladder program   : 31.2KW (when UM is 32KW)
                  : 15.2KW (When UM is 16KW)
                  : 7.2KW (When UM is 8KW )
                  : 3.2KW (When UM is 4KW )

Q:PC setup
U:Allocate UM
*:Compare programs
*:Edit PC ID
*:Customization
W:Net support table
  
```

2. Input the desired capacity (0 to 3KW) of the expansion DM area and press Enter. The enabled DM addresses will be displayed and the ladder program capacity will be reduced by the same amount. The cursor will move to the I/O comments area.

```

C200HS < > JM area

[ Utility ]

[ Allocate UM ]
Expansion DM      : 1KW (DM7000-DM7999 )
I/O Comment area : 0KW (0-31KW) (Priority: IR,LR,HR,AR,T/C )
                  (Approx. 0 Comments )

Ladder program   : 30.2KW (when UM is 32KW)
                  : 14.2KW (When UM is 16KW)
                  : 6.2KW (When UM is 8KW )
                  : 2.2KW (When UM is 4KW )

Q:PC setup
U:Allocate UM
*:Compare programs
*:Edit PC ID
*:Customization
W:Net support table
  
```

3. Press Escape to return to the Utility Menu without changing the capacity of the I/O area. Go on to step 4. to change the capacity of the I/O comments area.
4. Input the desired capacity for the I/O comments area, and press Enter. The approximate number of I/O comments enabled will be displayed, the ladder pro-

gram capacity will be reduced by the same amount, and a display to input the priority of I/O comment transfer will appear.

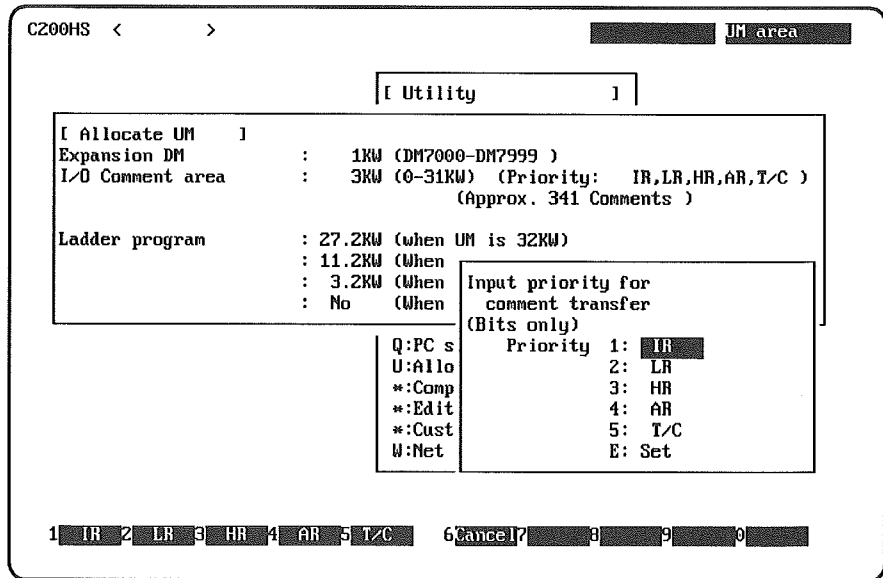

5. Using the F1 to F5 Keys and the Cursor Keys, designate the priority in which I/O comments are to be transferred as a part of the I/O comment area. To change a setting after it has been made, move the cursor to the position to be changed and press the F6 Key. The setting will be deleted. Then press a key between the F1 and F5 Keys to set the correct area.
6. Move the cursor to the "E:Set" and press the Enter Key to set the priority.
7. When all settings have been completed, press the Escape Key to return to the Utility Menu.



## SECTION 6

### System Setup

This section describes the various parameters that are set to control SSS operation and communications with the PC and SSS peripherals.

|       |   |     |
|-------|---|-----|
| 6-1   | System Setup Menu .....                                 | 206 |
| 6-2   | System Setup Parameters .....                           | 207 |
| 6-2-1 | PC Model .....  | 207 |
| 6-2-2 | PC Interface .....                                      | 207 |
| 6-2-3 | Network Address for SYSMAC NET PC, SYSMAC LINK PC ..... | 210 |
| 6-2-4 | I/O Table – UM Transfer .....                           | 211 |
| 6-2-5 | EPROM Interface .....                                   | 213 |
| 6-2-6 | Printer .....   | 214 |
| 6-2-7 | Data Disk Drive .....                                   | 215 |
| 6-2-8 | Output Bit Comment Type .....                           | 216 |
| 6-2-9 | Exit to DOS .....                                       | 216 |

## 6-1 System Setup Menu

The System Setup menu contains parameters for communications between the computer and the PC and between the computer and other devices such as printers, as well as parameters controlling general SSS operation. The System Setup menu and current settings are displayed when the SSS is started or when "Setup" is selected from the top-level offline menu.

**Note** The System Setup menu can be displayed in online mode, but I/O table – UM transfer is the only parameter that can be selected.

```

| Program |  D M  | I/O table | Utility | Setup | File mngt | Option |
|-----|-----|-----|-----|-----|-----|-----|
[ System setup  Ver  1.131
K:PC model      (C200HS )
C:PC interface (Com1)(HostLin)( 9600)(00unit)(EVEN)(?)(2)
N:Network address  (Net:000)(Node:001)
*:Message No.      (*)
U:I/O table       (I/O tbl )
  -- UM transfer  (Data lnk tbl)
                  (Bat detect OFF)
R:EPROM interface (Com1)(9600)
P:Printer model   (Wide Carriage Graphics)
D:Data disk drive (A:\SSSDAT\
O:OutBitCommentType (Instr comments)
M:Exit to DOS
  
```

The following table lists the operations that can be selected from the System Setup Menu. Select an operation by pressing its corresponding letter or moving the cursor to the operation and pressing Enter. These operations are described briefly in the following table and in more detail in later sections.

| Operation                 | Function   |
|---------------------------|--|
| K:PC model                | Specifies the model of PC that is being programmed or that is connected to the computer.   |
| C:PC interface            | Specifies whether the computer is connected to the PC through a peripheral bus connection, a Host Link interface, or a SYSMAC NET Link Unit.   |
| N:Network address         | Specifies the network address and node number of the PC with which to communicate when using a SYSMAC NET interface to the PC.   |
| U:I/O table --UM transfer | Specifies whether the I/O table and data link tables are transferred to the user program area when the user program is transferred between the computer and PC or PROM Writer. Also specifies whether battery errors are detected. |
| R:EPROM interface         | Specifies the communications protocol between the PROM Writer and computer.  |
| P:Printer model           | Specifies the type of printer connected.   |
| D:Data disk drive         | Specifies the data disk drive.   |
| O:Out Bit Comment Type    | Specifies whether I/O comments or instruction comments are displayed when the program display is set to Ladder w/ comments format.   |
| M:Exit to DOS             | Terminates SSS operation and returns to DOS.   |

## 6-2 System Setup Parameters

### 6-2-1 PC Model

Use this parameter to indicate which model of PC will be used with the SSS. The PC Interface parameter will be initialized when the PC model is changed and, if the PC model is changed between any of the PC families in the following table, the current ladder program, I/O comments, block comments, instruction trace data, time chart data, and data trace data in the computer will be cleared. A confirmation message will appear before the data is actually cleared so that you can cancel the operation if necessary.

| Family | PCs   |
|--------|---|
| C2000H | C200H, C1000H, C2000H, Mini H-type PCs, K-type PCs, CQM1, C200HS, and C200HX/200HG/C200HE |
| C500   | C20, C50, P-type PCs, C120, and C500  |
| CVM1   | All CVM1 PCs  |

The procedure for changing the PC model is as follows:

- 1, 2, 3... 1. Select "K:PC model" from the System Setup Menu.

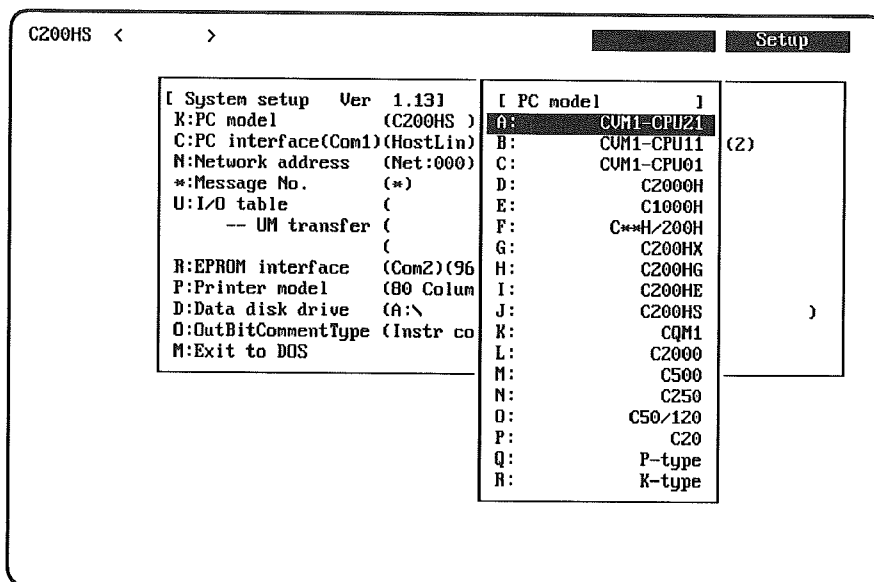

2. Select the desired PC model from the submenu.  
If "C\*\*H/200H" is selected, "C200H" will be displayed.
3. A confirmation prompt will be displayed if the PC family has been changed. Enter "Y" to change the PC model and erase the current ladder program in the computer, enter "N" to cancel the operation.

### 6-2-2 PC Interface

Use this operation to indicate which type of Unit is being used for communications between the computer and PC: A peripheral bus connection, a Host Link interface, or a SYSMAC NET interface.

**Peripheral** Use the following procedure to set the PC Interface to the peripheral bus interface.

- 1, 2, 3... 1. Set the communications baud rate on the PC's DIP switch to match the baud rate that you will set in step 4.

2. Select "C:PC interface" from the System Setup Menu.

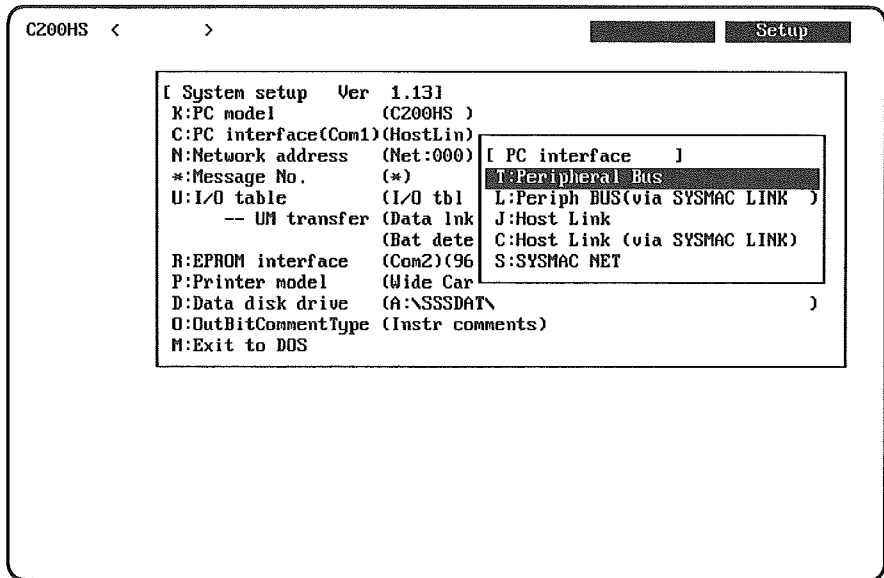

3. Select "T:Peripheral Bus" from the submenu.
4. Set the computer connector to be used (Com No.) and, for the CQM1 or C200HS, set the baud rate.

#### Peripheral Bus (via SYSMAC LINK)

Use the following procedure to set the PC Interface when communicating with a C200HS or C200HX/HG/HE PC that is in a SYSMAC LINK network and the local PC is being connected through the peripheral bus. This setting is valid only for C200HS or C200HX/HG/HE PCs connected online through a CQM1-CIF01.

**Note** This setting can be selected for any PC model, but a communications error will occur unless the PC is a C200HS or C200HX/HG/HE connected through a CQM1-CIF01.

- 1, 2, 3... 1. Select "C:PC interface" from the System Setup Menu.

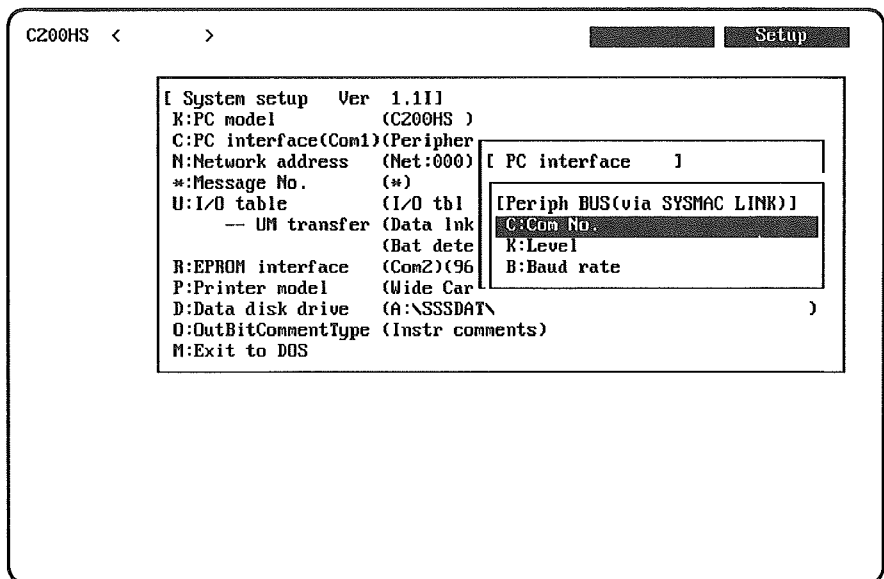

2. Select "L:Peripheral Bus (via SYSMAC LINK)."



3. Select "K:Operating level" and set the operating level to the PC's operating level in the SYSMAC LINK network.
4. Select "B:Baud rate" and set the communications baud rate.

**Host Link**

Use the following procedure to set the PC Interface for a Host Link interface. Press Escape to return to the System Setup Menu.

- 1, 2, 3...
1. If a Host Link Unit is being used, make the following settings on the Host Link Unit's DIP switch. With the C200H, set the command level settings to even parity, 7 data bits, and 2 stop bits.
    - a) Transmission protocol: ..... 1:N
    - b) Command level: ..... 1, 2, and 3
    - c) Synchronization switching: ..... Internal synchronization
    - d) CTS switching ..... Always ON
  2. Select "C:PC interface" from the System Setup Menu.
  3. Select "J:Host Link" from the submenu.
  4. Set the connector number, the host link unit number, and the baud rate as required.

**Host Link (via SYSMAC LINK)**

Use the following procedure to set the PC Interface when communicating with a PC that is in a SYSMAC LINK network and the local PC is being connected through the Host Link. This setting is valid for either of the following configurations:

A C200H, C1000H, or C2000H PC connected online using a C200H-IP007 or C120-LK201-V1. A C200HX/HG/HE PC connected online using an RS-232C cable.

- 1, 2, 3... 1. Select "C:PC interface" from the System Setup Menu.

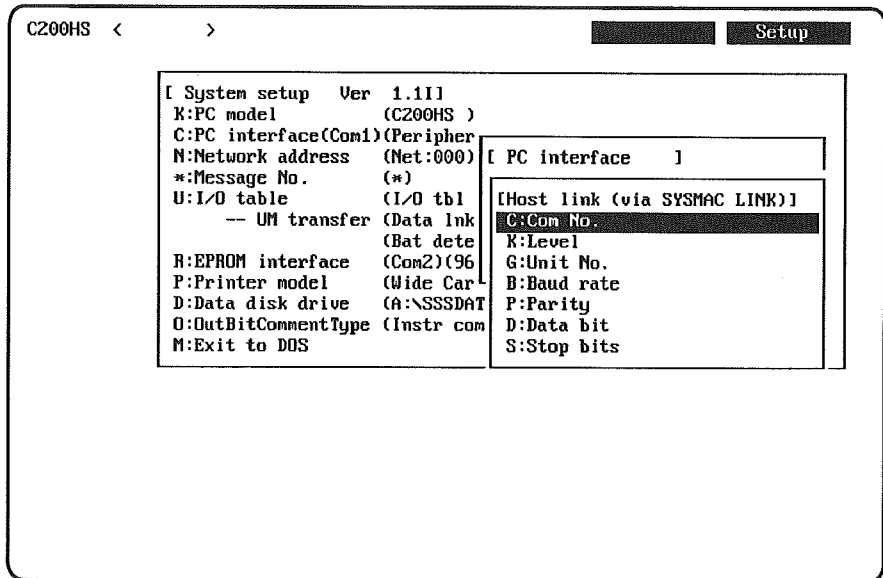

2. Select "C:Host Link (via SYSMAC LINK)."
3. Set the operating level, baud rate, number of data bits, the host link unit number, parity, and number of stop bits as required.

**Note**

1. The Host Link (via SYSMAC LINK) setting can be used for host computer connected to the local PC by a remote modem connection. Refer to 2-5 Modem Connections in the SSS Operation Manual: Basics for details on the PC models that can be used and the required communications settings.

- When a C200HX/HG/HE PC is connected through a Communications Board, the SYSMAC LINK – Peripheral Device Initialization Bit (AR 2403) must be turned ON when changing the SSS communications port.

**SYSMAC NET** Use the following procedure to set the PC Interface for a SYSMAC NET interface. SYSMAC NET Link Units are supported by the following PCs: C500, C200H, C200HS, C200HX/HG/HE, C1000H, C2000, and C2000H.

- 1, 2, 3... 1. Select "C:PC interface" from the System Setup Menu.
2. Select "S:SYSMAC NET" from the submenu. The following submenu will appear.

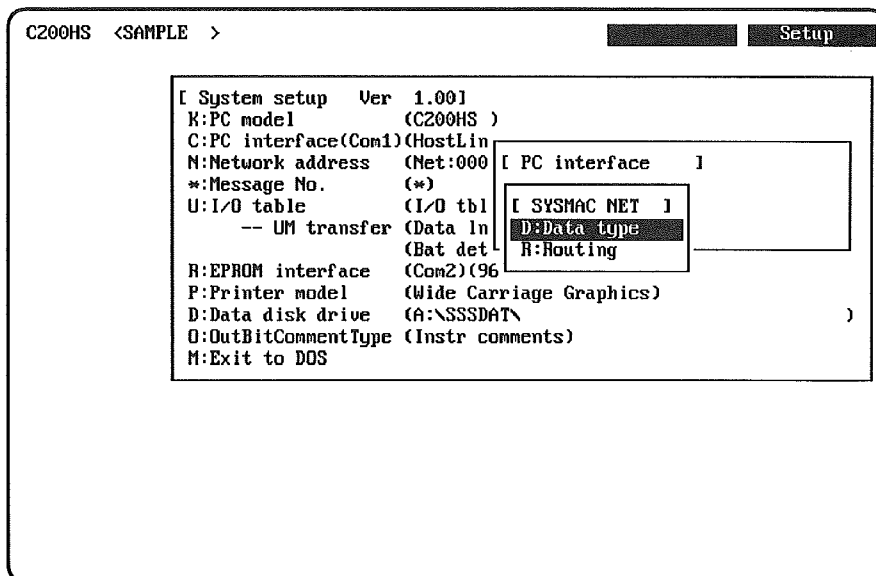

3. Select "D:Data type" to set the data type.
4. Select "R:Routing" to set routing tables. Refer to *14-5 Creating and Modifying Routing Tables* for details on routing table settings.
5. Press F10 (END) after completing all settings. Any settings made will be erased if the operation is terminated by pressing Escape.

### 6-2-3 Network Address for SYSMAC NET PC, SYSMAC LINK PC

The Network Address parameter is used to specify the network address and node number (address) of the PC with which the SSS is to communicate with on a SYSMAC NET network or SYSMAC LINK network.

- 1, 2, 3... 1. Select "N:Network address" from the System Setup Menu. The following display will appear giving you the local node and network address and asking for the network and node addresses of the PC with which to communicate.

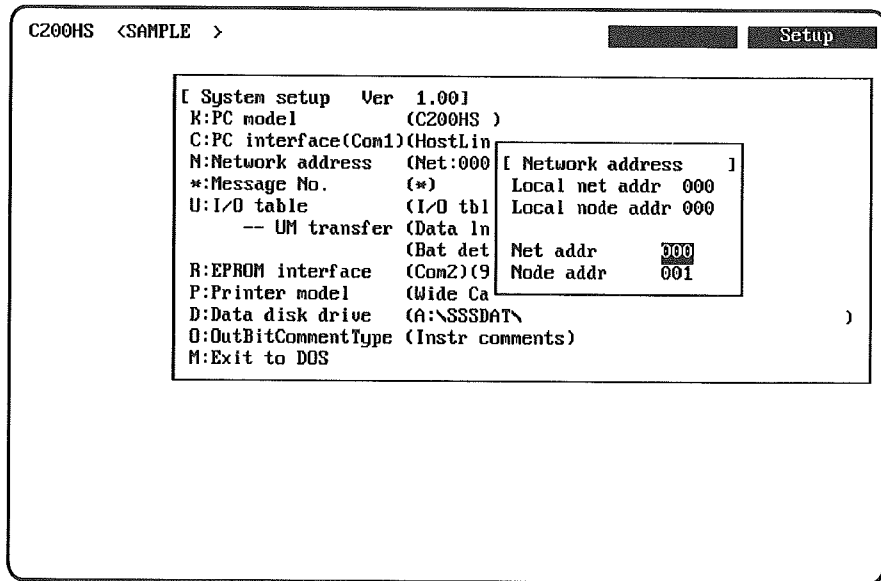

2. Input the network address and node address of the PC with which to communicate, pressing Enter after each. The network address for SYSMAC NET can be between 000 and 127; the node address, between 001 and 126. The node address for SYSMAC LINK can be between 00 and 62.

#### 6-2-4 I/O Table – UM Transfer

This parameter indicates whether to transfer the I/O table and/or data link table to the UM (program memory) along with the program when the program is transferred between the computer and PC or EPROM. This operation can be performed when the computer is offline or online.

The I/O table and data link table transferred to the PC will be valid the next time the PC is turned on.

The I/O table-UM transfer operation also applies to program comparisons between the computer and PC or EPROM, so the I/O table and/or data link table will be compared along with the program if this parameter is set to "Y."

If the "Inhibit bat low alarm" is set to "Y," a low PC battery won't be detected when the program is transferred.

The I/O table transfer setting is valid only when the PC model is set to C120, C500, C1000H, or C2000H.

**Data Link Table** The data link table setting is valid only when the PC model is set to C1000H or C2000H. The data link table cannot be transferred with the C200H, C200HX/HG/HE,

or CQM1. If the program memory (UM) is read from the computer, those addresses assigned to the data link table will be displayed as undefined instructions (?????). If the C1000H or C2000H PC has a SYSMAC NET Link System with two operating levels, only the data link table for operating level #1 will be transferred. If there is no data link table for operating level #1, the data link table for operating level #0 will be transferred as the data link table for operating level #1.

**Procedure** Use the following procedure to set the computer to transfer the I/O table and/or data link table.

- 1, 2, 3... 1. Select "U:I/O table-UM transfer" from the System Setup Menu.

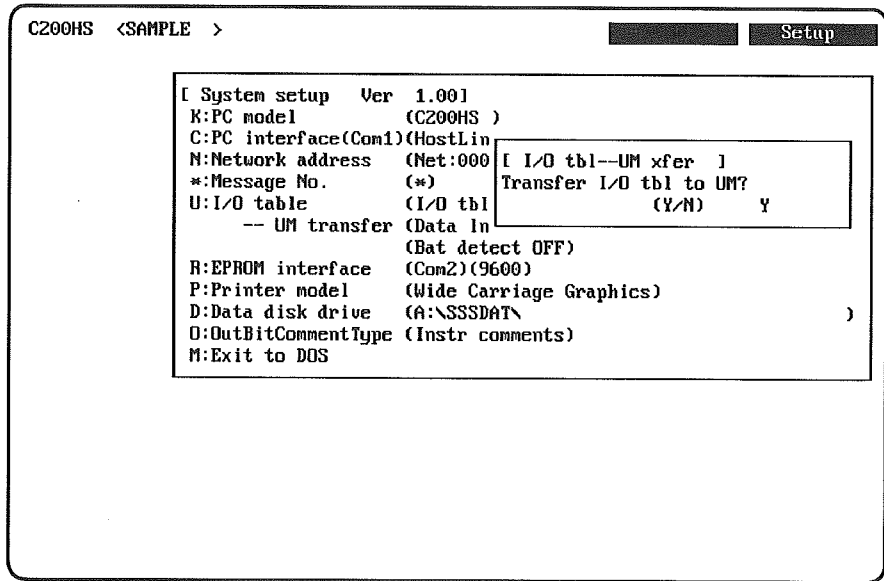

2. Enter "Y" to enable I/O table transfer. The prompt for battery error detection will be displayed.

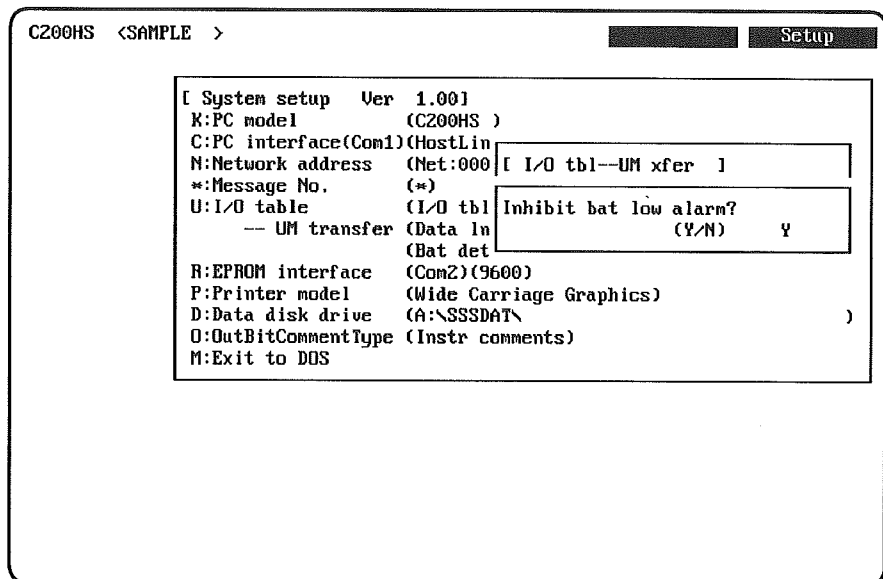

3. Enter "Y" to disable low battery detection. The prompt for data link table transfer will be displayed.

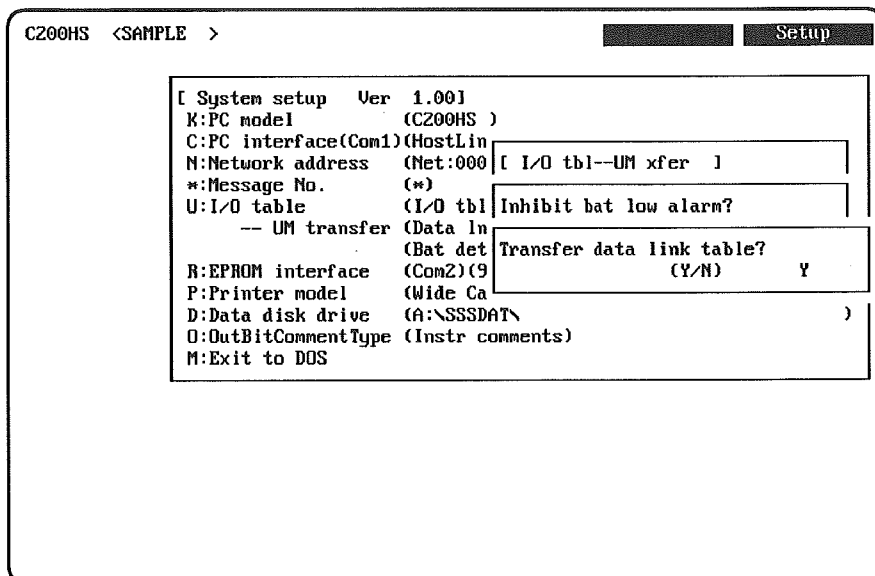

4. Enter "Y" to enable data link table transfer.

### 6-2-5 EPROM Interface

The EPROM interface parameter sets the communications protocol for program transfers between the PROM Writer and computer. The following table shows the communications parameters that should be set in the PROM Writer. If a PKW-3100 PROM Writer is being used, set the ROM type and transmission format to the Intel HEX format.

| Item      | Setting        |
|-----------|----------------|
| Baud rate | 9,600 bps max. |
| Data bits | 7 data bits    |
| Stop bits | 2 stop bits    |
| Parity    | Even           |

- 1, 2, 3... 1. Select "R:EPROM interface" from the System Setup Menu.

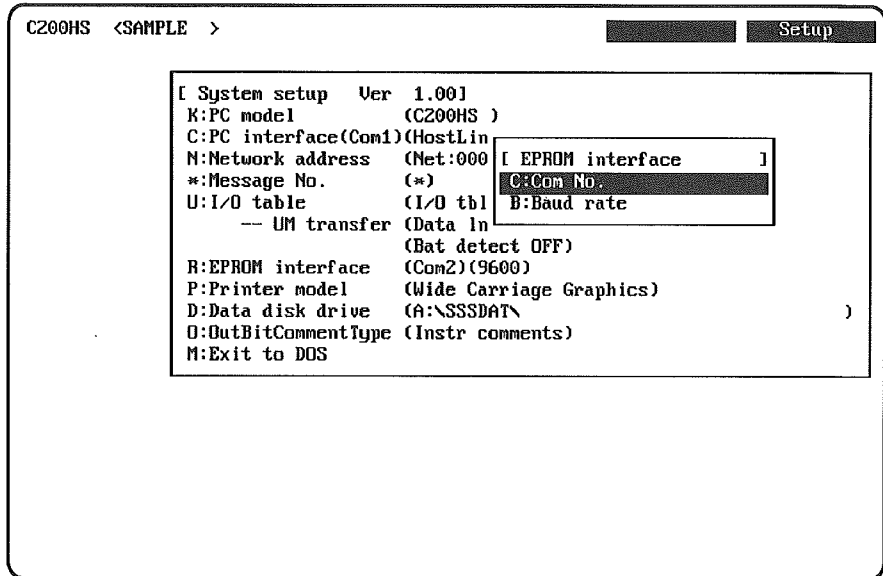

2. Set the computer connector to be used for the PROM Writer and set the baud rate to the same rate as the one set in the PROM Writer.

Press Escape to leave the operation and return to the System Setup Menu.

## 6-2-6 Printer

This operation is used to specify the model of the printer connected to the computer. Wide carriage graphics, 80-column graphics (wide carriage), or other printers that are the same will be formatted to 80 columns. Compressed graphic printers and 80-column draft printers can also be used. If an 80-column printer is used, the following can be printed: ladder diagrams, mnemonic lists, data area lists, cross reference lists, and I/O table lists.

**Note** A3-size printing is not supported by the SSS.

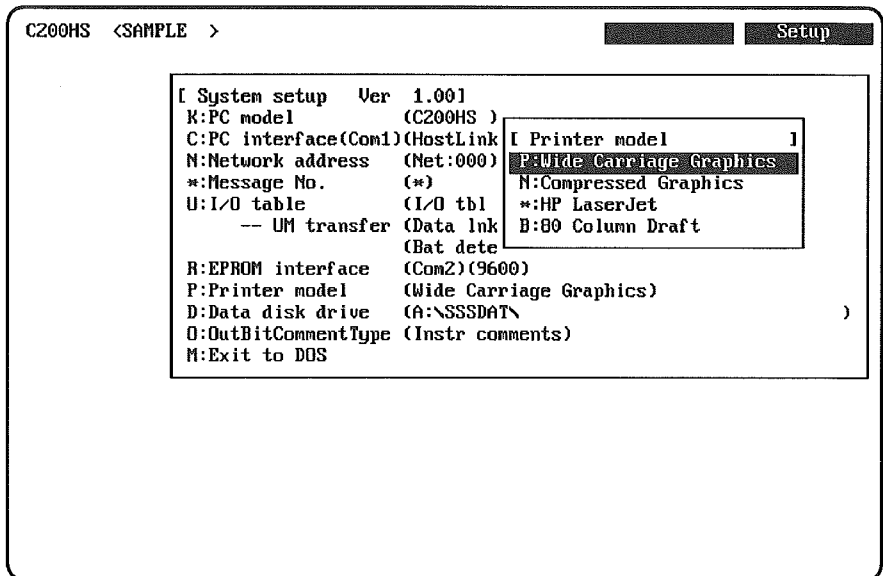

To change the presently displayed printer model to another, use the cursor to highlight the Printer parameter and press Return. A submenu will be displayed allowing one of the three supported printer models to be selected. The printer must also be correctly set to communicate with the computer. Use the following table to set up the printer:

| Item                              | Setting   |
|-----------------------------------|---|
| Line length (for wide carriage)   | 345 mm (13.6 in.)   |
| Line length (for narrow carriage) | 177 mm (7.5 in.)  |
| Zero                              | Normal zeros  |
| Automatic line feed               | No line feed after carriage return  |
| Form length                       | 11 inch   |
| Character Sec                     | Sec 1.  |
| Automatic carriage return         | Prevents automatic carriage return On line feed, vertical tab and Escape. |
| Character quality                 | High quality  |
| Paper feed position               | 22 mm   |
| Contracted characters             | Invalid   |
| Short tear off                    | Invalid   |
| ESC/P super function              | OFF   |
| Automatic return                  | Invalid   |
| Page length                       | 11 inches   |
| Cut sheet feeder                  | Invalid   |
| 1-inch scoring skip               | Invalid   |

### 6-2-7 Data Disk Drive

This parameter specifies the default floppy disk drive used for data disks. A directory path can be added to the drive name.

- 1, 2, 3...
1. Select "D:Data disk drive" from the System Setup Menu. The drive and path names used for the SSS installation are used for the default disk drive.

The screenshot shows a terminal window titled "C200HS <SAMPLE >" with a "Setup" button in the top right corner. The menu is as follows:

```

[ System setup   Ver  1.001
  K:PC model    (C200HS )

[ Data disk drive]
A:\SSSDAT\

  -- UM transfer (Data lnk tbl)
                    (Bat detect OFF)
R:EPROM interface (Com2)(9600)
P:Printer model   (Wide Carriage Graphics)
D:Data disk drive (A:\SSSDAT\ )
O:OutBitCommentType (Instr comments)
M:Exit to DOS

```

2. Enter the desired drive name and path name. The path name can be up to 66 characters long.

### 6-2-8 Output Bit Comment Type

Use this parameter to specify whether the comments displayed by output instructions should be instruction comments or I/O comments. The choice made here will be relevant only while in the "Ladder w/ comments" mode.

The affected instructions are OUT, OUT NOT, TIM, CNT, KEEP, DIFU, DIFD, STEP, and SNXT. The instruction comments will be displayed next to any other instructions even if this parameter is set to I/O comments.

- 1, 2, 3... 1. Select "O:Out Bit Comment Type" from the System Setup Menu.

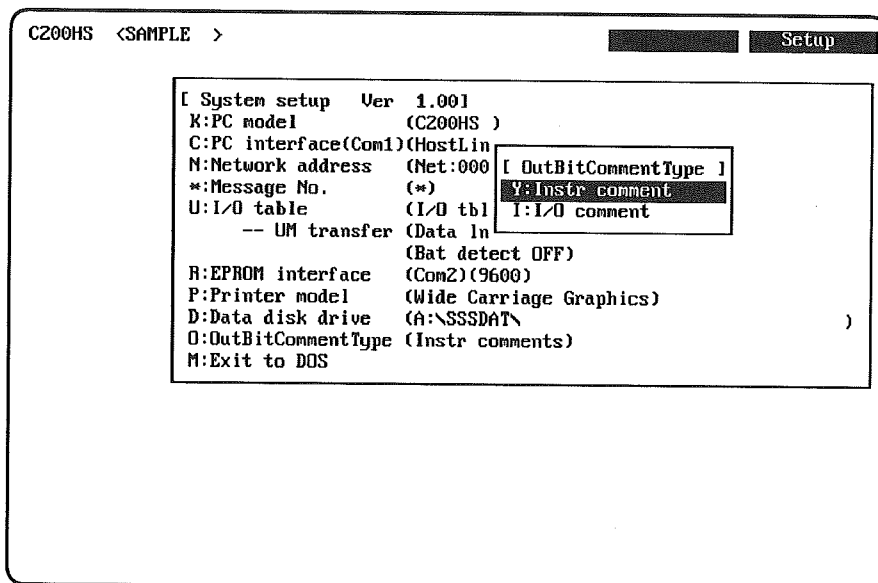

2. Select the desired comment type from the submenu.

### 6-2-9 Exit to DOS

Use this command to exit SSS and return to DOS. Be sure to save any data in SSS to a disk before exiting to DOS. This command can be executed when the computer is offline only.

- 1, 2, 3... 1. Select "M:Exit to DOS" from the System Setup Menu.
2. A confirmation prompt will be displayed. Enter "Y" to exit to DOS, "N" to return to the System Setup Menu.



# SECTION 7

## File Management

This section explains how to manage files on data disks. Here, a data disk can be either a floppy disk or a directory on your hard disk.

|       |   |     |
|-------|---|-----|
| 7-1   | File Management Operations .....              | 218 |
| 7-1-1 | Changes from LSS .....                        | 218 |
| 7-1-2 | Summary of Operations .....                   | 218 |
| 7-2   | DOS File Operations .....                     | 219 |
| 7-2-1 | Displaying the DOS File Management Menu ..... | 219 |
| 7-2-2 | Displaying Directories .....                  | 219 |
| 7-2-3 | Copying Files .....                           | 221 |
| 7-2-4 | Changing File Names .....                     | 222 |
| 7-2-5 | Deleting Files .....                          | 222 |
| 7-2-6 | Creating Directories .....                    | 223 |
| 7-2-7 | Deleting Directories .....                    | 224 |
| 7-3   | LSS File Operations .....                     | 224 |
| 7-3-1 | Displaying the LSS File Management Menu ..... | 224 |
| 7-3-2 | Displaying Directories .....                  | 225 |
| 7-3-3 | Copying Files .....                           | 226 |
| 7-3-4 | Changing File Names .....                     | 230 |
| 7-3-5 | Deleting Files .....                          | 230 |

## 7-1 File Management Operations

The operations described in this section can be used to display, copy, rename, and delete files stored on data disks or the hard disk and to create and delete directories.

### 7-1-1 Changes from LSS

Several functions have been added to the LSS "File management" operation to improve the performance of the SSS. One function has been eliminated. The changes are described below.

- Directories for managing DOS files can now be created and deleted.
- No more than 1 MB of LSS data could be stored on the hard disk, but this limitation does not apply to DOS files.
- File management can now be carried out only in the offline mode. "File management" can no longer be selected while in the online mode; to carry out file management operations one must first return to the offline mode.
- The "Merge program" operation has been eliminated.

### 7-1-2 Summary of Operations

Both DOS and LSS files can be managed. There is a separate menu of available operations for managing each of these types of files (or rather, there is a LSS File Management Submenu under the File Management (DOS) Menu. The operations available through the File Management (DOS) and LSS File Management Menus are explained in the following tables.

For detailed explanations of the operations accessed through these menus, refer to *7-2 DOS File Operations* and *7-3 LSS File Operations*.

#### DOS File Management Menu

| Operation              | Function  |
|------------------------|---|
| I:Directory            | Displays directories for programs, I/O comments, I/O tables, etc., on the screen. File directories can be displayed individually by type. |
| C:Copy file            | Copies files.   |
| N:Change file name     | Renames files.  |
| D:Delete file          | Deletes files.  |
| R:Create/del directory | Creates or deletes subdirectories under the current directory.  |
| L:LSS file management  | Switches to the "LSS File Management" menu.   |

#### LSS File Management Menu

| Operation          | Function   |
|--------------------|--|
| I:Directory        | Displays directories for programs, data memory, I/O tables, etc., on the screen. File directories can be displayed individually by type. |
| C:Copy file        | Copies files.  |
| N:Change file name | Renames files.   |
| D:Delete file      | Deletes files.   |

**Note** Press Escape twice from the LSS File Management Menu to return to the File Management (DOS) Menu.

## 7-2 DOS File Operations

This section explains operations involving DOS file management.

### 7-2-1 Displaying the DOS File Management Menu

As explained in the following procedure, the menu that first appears when "File management" is selected is the DOS File Management Menu. In order to access the LSS File Management Menu, it is necessary to select "L:LSS file management" from the DOS File Management Menu.

- 1, 2, 3... 1. Select "File management" from the top-level offline menu. The DOS File Management Menu will be displayed.

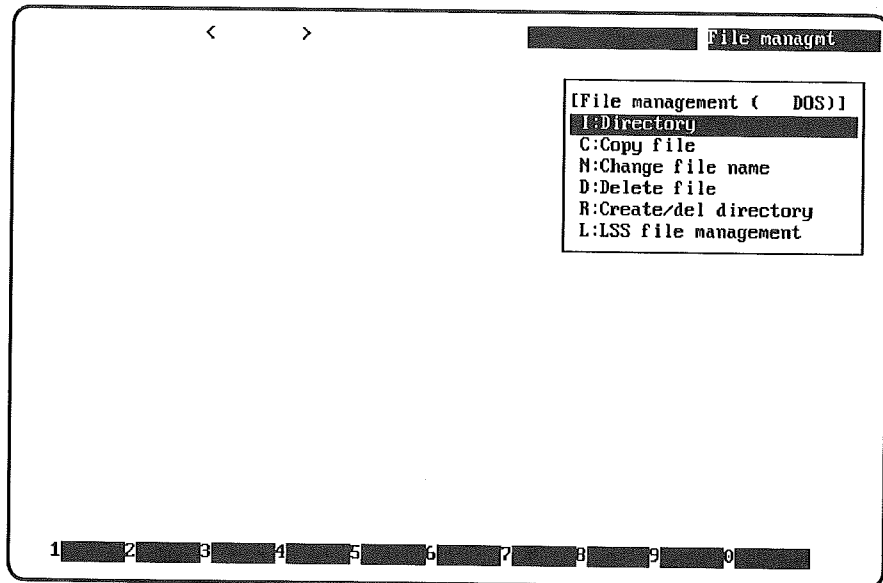

2. Select the operation that is to be carried out. Each of these menu operations is explained beginning with 7-2-2 *Displaying Directories*. To display the LSS File Management Menu, select "L:LSS file management."

### 7-2-2 Displaying Directories

The "L:Directory" operation can be used to display directories of programs, DM files, I/O comments, and so on, on the screen. When this operation is executed, the files will be displayed for the drive and path names set under "Data disk drive" in the System Setup. For each file listed in a directory, the file name, size, and date will be displayed.

- **File name:** The file name and type specified when the file was saved.
- **Size:** The number of bytes the file occupies in memory. If <DIR> is displayed in the size frame, the name is a directory name.
- **Date:** Shows the date when the file was saved. Automatically appended when the file is saved.

- Note**
1. Path names are set by the "Data disk drive" parameter in the System Setup. If another drive is to be used, the "Data disk drive" parameter must be changed.
  2. Programs blocks saved with the "Program block" operation can be read only through the "Z:All (other)" option.

Procedure

- 1, 2, 3... 1. Select "I:Directory" from the DOS File Management Menu.

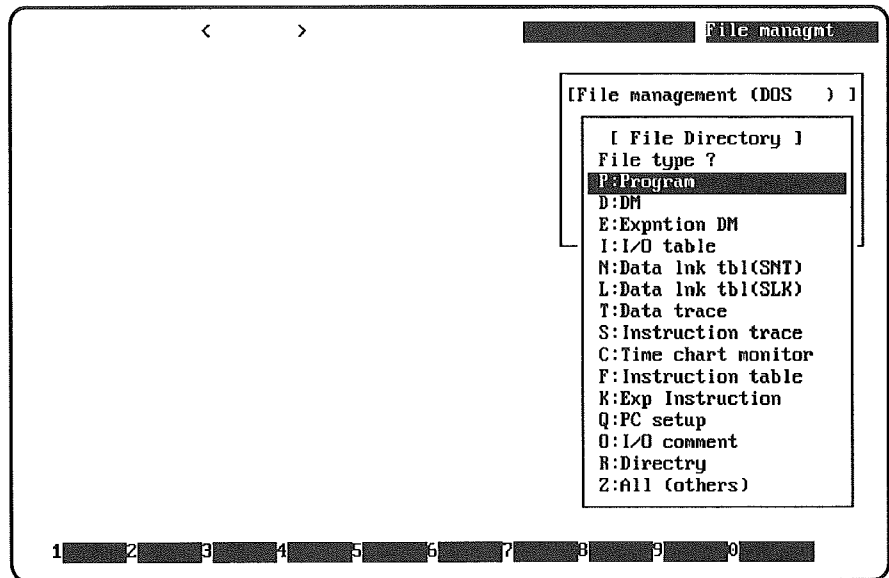

2. Select the type of file for which the directory is to be displayed. After the selection has been made, the directory will be displayed. If that type of file does not exist, a message will indicate so.

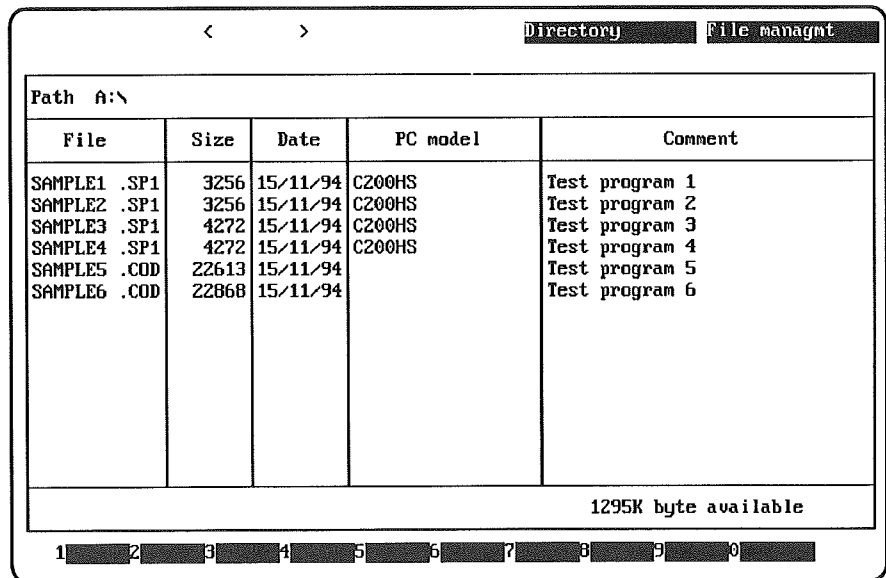

3. If there is information on the next page, a message in the lower left corner of the screen will indicate so. Press the PageDown Key to scroll to the next page.

**Extensions** The file name extensions are shown in the following table.

| File type                       | Created by SSS | Created by LSS | Created by CVSS |
|---------------------------------|----------------|----------------|-----------------|
| Program                         | SP1, COD       | —              | COD             |
| DM                              | SL4, DMD       | —              | DMD             |
| Expansion DM                    | EDM            | —              | EDM             |
| I/O table                       | SP5, IOT       | —              | IOT             |
| Data link table,<br>SYSMAC NET  | SN2, SNT       | —              | SNT             |
| Data link table,<br>SYSMAC LINK | SLK            | SLK            | SLK             |
| Data trace                      | SD1, DTR       | —              | DTR             |
| Instruction trace               | SD2            | —              | —               |
| Time chart monitor              | SD3            | —              | —               |
| Instructions table              | SP3            | —              | —               |
| Expansion<br>instructions       | SE1            | —              | —               |
| PC Setup                        | SP7, CPU       | —              | CPU             |
| I/O comment                     | CMT            | —              | CMT             |

### 7-2-3 Copying Files

The “C:Copy file” operation can be used to copy files.

**Caution** When copying a file to another drive, check to be sure that there is no file on that drive with the same file name. If there is a file with the same name, it will be overwritten and the data will be lost. No warning message will be displayed, so be careful not to overwrite any existing files.

To execute “C:Copy file,” follow the procedure outlined below.

- 1, 2, 3... 1. Select “C:Copy file” from the DOS File Management Menu. The screen for selecting the file type will be displayed. (See 7-2-2 *Displaying Directories*.)
2. Select the type of file that is to be copied. (In this example, “P:Program” is selected.)

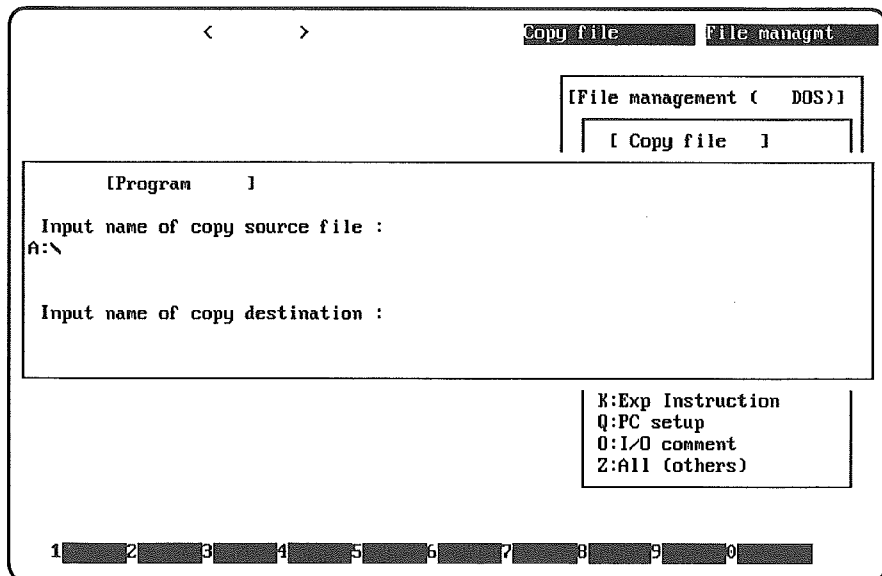

3. Check the path name and change it if it is different from the data disk drive.
4. Input the name of the source file (i.e., the file that is to be copied), and press the Enter Key.
5. Input the destination file name and press the Enter Key. (The End Key cannot be used.)
6. To begin the copy operation, press the Enter Key again.

### 7-2-4 Changing File Names

The "N:Change file name" operation can be used to change the names of files on the data disk in the data disk drive.

- 1, 2, 3...**
1. Select "N:Change file name" from the DOS File Management Menu. The screen for selecting the file type will be displayed. (See 7-2-2 *Displaying Directories*.)
  2. Select the type of file that is to be copied. (In this example, "P:Program" is selected.)

The screenshot shows a DOS File Management Menu. At the top, there are navigation arrows and two menu items: "Change file name" and "File managnt". Below these, a sub-menu is displayed with the following options: "[File management ( DOS)]" and "[ Change File Name ]". The "Change File Name" option is selected. Below the sub-menu, the screen displays the following text: "[Program ]", "Input file name :", "A:\", "Input new file name :", and "[ ]". At the bottom right, there are two options: "0:1/0 comment" and "Z:All (others)". At the bottom of the screen, there is a row of numbers from 1 to 0, each in a small box.

3. Check the path name and change it if it is different from the data disk drive.
4. Input the file name that is to be changed, and press the Enter Key.
5. Input the new file name and press the Enter Key. The file name will then be changed to the new name.

### 7-2-5 Deleting Files

The "D:Delete file" can be used to delete files from the data disk in the data disk drive.

- 1, 2, 3...**
1. Select "D:Delete file" from the DOS File Management Menu. The screen for selecting the file type will be displayed. (See 7-2-2 *Displaying Directories*.)

2. Select the type of file that is to be deleted. (In this example, "P:Program" is selected.)

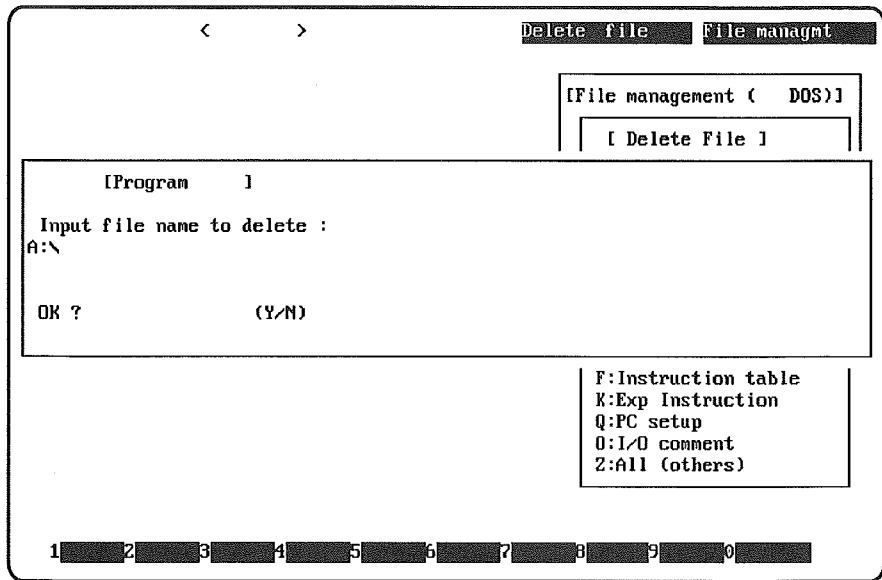

3. Check the path name and change it if it is different from the data disk drive.
4. Input the name of the file that is to be deleted, and press the Enter Key. A message will ask for confirmation.
5. To delete the file, input "Y" and press the Enter Key. To cancel the operation, press either the Enter Key or the Escape Key.

### 7-2-6 Creating Directories

The "R:Create directory" operation can be used to create subdirectories under the current directory. Up to eight normal-size characters can be used in a file name. To change the current directory, change the data disk drive in the System Setup.

- 1, 2, 3... 1. Select "R:Create/del directory" from DOS File Management Menu.

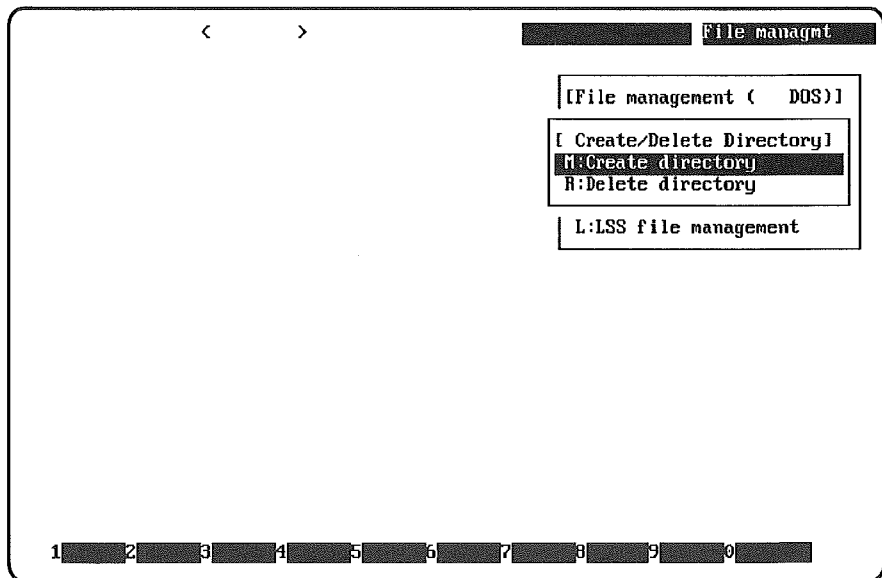

2. Select "M:Create directory" from the Create/Delete Directory Menu, and press the Enter Key. The current directory will be displayed.
3. Input the name of the subdirectory that is to be created, and press the Enter Key. The new subdirectory will then be created under the current directory, with the name that was input.

### 7-2-7 Deleting Directories

The "R:Delete directory" operation can be used to delete specified subdirectories under the current directory. No subdirectory can be deleted if it contains files or other subdirectories.

To change the current directory, change the data disk drive in the System Setup.

- 1, 2, 3... 1. Select "R:Create/del directory" from DOS File Management Menu.

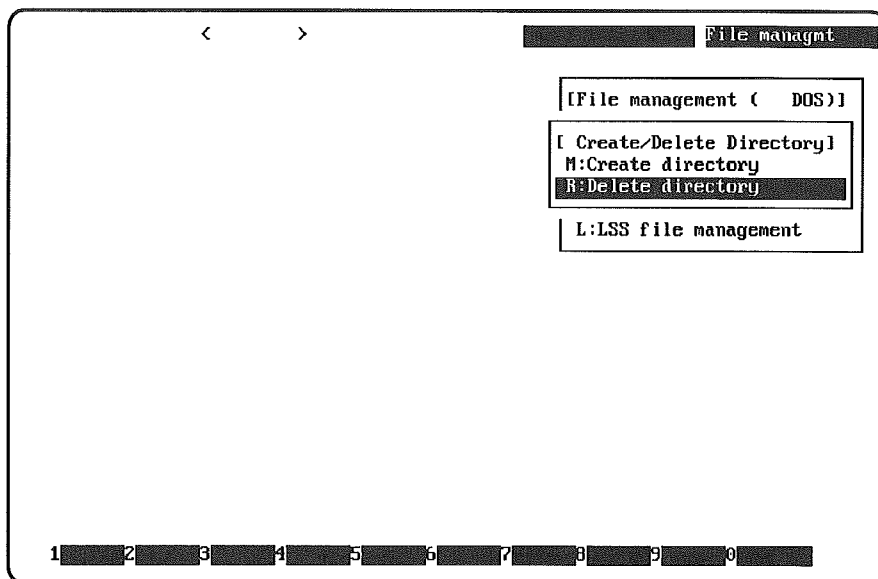

2. Select "R:Delete directory" from the Create/del Directory Menu, and press the Enter Key. The current directory will be displayed.
3. Input the name of the subdirectory that is to be deleted, and press the Enter Key. A message will ask for confirmation.
4. To delete the subdirectory, input "Y" and press the Enter Key. To cancel the operation, press either the Enter Key or the Escape Key.

## 7-3 LSS File Operations

This section explains operations involving managing LSS-compatible files.

### 7-3-1 Displaying the LSS File Management Menu

- 1, 2, 3... 1. Place an LSS floppy disk in the disk drive or be sure an LSS library has been created in the current directory on the hard disk.
2. Change the data disk drive setting in the System Setup if it is different from the one to be accessed.
  3. Select "File management" from the top-level offline menu. The DOS File Management Menu will be displayed.
  4. Select "L:LSS file management" from the DOS File Management Menu. A list of files will be displayed in the current LSS library.



5. Press the End Key. The LSS File Management Menu will be displayed.

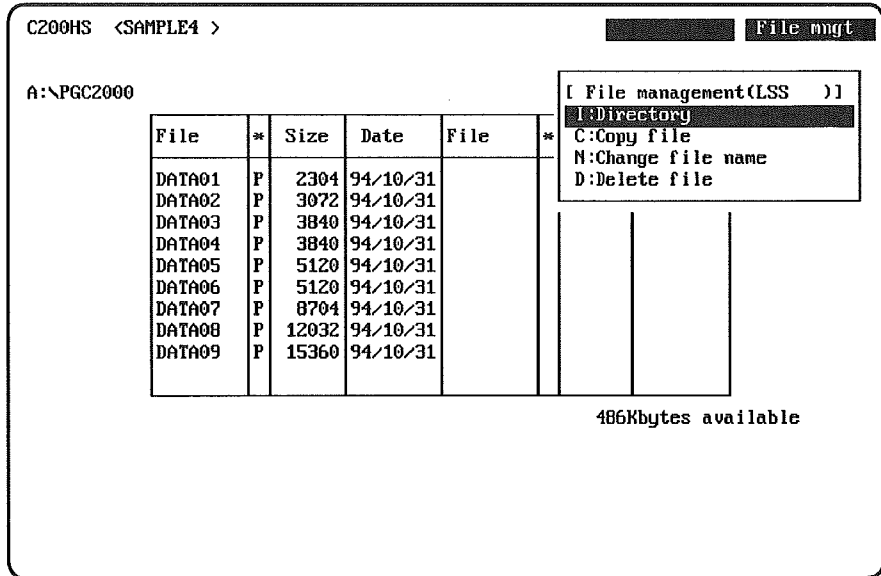

6. Select the operation that is to be carried out. Each of these menu operations is explained in detail beginning with 7-3-2 *Displaying Directories*. To display the DOS File Management Menu, press Escape twice from the LSS File Management Menu.

### 7-3-2 Displaying Directories

The "I:Directory" operation can be used to display directories of programs, DM files, I/O comments, and so on, on the screen. When this operation is executed, the files will be displayed for the drive and path names set under data disk drive parameter in the System Setup. For each file listed in a directory, the file name, size, and date will be displayed. If there are no files stored on the data disk, a message at the bottom of the screen will indicate so.

- **File name:** The file name and type specified when the file was saved.
- **File type:** The file type is indicated by a letter of the alphabet, as shown in the following table.

|   |                      |   |                             |
|---|----------------------|---|-----------------------------|
| P | Program file         | S | Instruction trace file      |
| D | DM file              | C | Time chart monitor file     |
| I | I/O table file       | F | Instructions table file     |
| L | Data link table file | K | Expansion instructions file |
| T | Data trace file      | Q | PC Setup file               |

- **Size:** The number of bytes the file occupies in memory.
- **Date:** Shows the date when the file was saved. Automatically appended when the file is saved.

**File List** The screen for displaying the list of files in a directory appears as follows:

C200HS <SAMPLE > File mngt

A:\PGC2000

| File   | * | Size  | Date     | File | * | Size | Date |
|--------|---|-------|----------|------|---|------|------|
| DATA01 | P | 2304  | 94/10/31 |      |   |      |      |
| DATA02 | P | 3072  | 94/10/31 |      |   |      |      |
| DATA03 | P | 3840  | 94/10/31 |      |   |      |      |
| DATA04 | P | 3840  | 94/10/31 |      |   |      |      |
| DATA05 | P | 5120  | 94/10/31 |      |   |      |      |
| DATA06 | P | 5120  | 94/10/31 |      |   |      |      |
| DATA07 | P | 8704  | 94/10/31 |      |   |      |      |
| DATA08 | P | 12032 | 94/10/31 |      |   |      |      |
| DATA09 | P | 15360 | 94/10/31 |      |   |      |      |

The files on the data disk that is set for the data disk drive are displayed.

486Kbytes available  
Memory remaining in library.

Press the F3 Key to change the library.

1 2 3 Name 4 5 6 7 8 9 0

A maximum of 255 files can be stored on the data disk. If all of the file names cannot be displayed on a single screen, a message will be displayed indicating that there are more pages. Use the PageDown and PageUp Keys to scroll between pages. The F3 Key switches between libraries (C2000H and C500).

**Procedure** In this example, a list of DM files is displayed.

- 1, 2, 3... 1. Select "I:Directory" from the LSS File Management Menu.

C200HS <SAMPLE > Directory File mngt

A:\PGC2000

| File   | * | Size  | Date     | File | * |
|--------|---|-------|----------|------|---|
| DATA01 | P | 2304  | 94/10/31 |      |   |
| DATA02 | P | 3072  | 94/10/31 |      |   |
| DATA03 | P | 3840  | 94/10/31 |      |   |
| DATA04 | P | 3840  | 94/10/31 |      |   |
| DATA05 | P | 5120  | 94/10/31 |      |   |
| DATA06 | P | 5120  | 94/10/31 |      |   |
| DATA07 | P | 8704  | 94/10/31 |      |   |
| DATA08 | P | 12032 | 94/10/31 |      |   |
| DATA09 | P | 15360 | 94/10/31 |      |   |

[ File management(LSS ) ]

I:Di

C:Co [ Directory ]

N:Ch File type?

D:De P:Program

D:DM

I:I/O table

N:Data link table

T:Data trace

S:Instruction trac

C:Time chart moni

F:Instructions tbl

K:Expansion instr

Q:PC setup

Z:All

48

2. Select "D:DM." A list of DM files will be displayed.

### 7-3-3 Copying Files

The "C:Copy file" operation can be used to copy files within the same data disk or to a different data disk.

**Note** It is not possible to copy files between different types of data libraries.

Procedure 1: Copying Within the Same Data Disk

- 1, 2, 3... 1. Select "C:Copy file" from the LSS File Management Menu.

C200HS <SAMPLE > Copy file File mgmt

A:\PGC2000

| File   | * | Size  | Date     | File | * |
|--------|---|-------|----------|------|---|
| DATA01 | P | 2304  | 94/10/31 |      |   |
| DATA02 | P | 3072  | 94/10/31 |      |   |
| DATA03 | P | 3840  | 94/10/31 |      |   |
| DATA04 | P | 3840  | 94/10/31 |      |   |
| DATA05 | P | 5120  | 94/10/31 |      |   |
| DATA06 | P | 5120  | 94/10/31 |      |   |
| DATA07 | P | 8704  | 94/10/31 |      |   |
| DATA08 | P | 12032 | 94/10/31 |      |   |
| DATA09 | P | 15360 | 94/10/31 |      |   |

[ File management(LSS ) ]

I:Dir

C:Cop [ Copy file ]

N:Cha **S:To same floppy**

D:Del D:To new floppy

486Kbytes available

2. Select "S:To same floppy" The following menu will be displayed.

C200HS <SAMPLE > Copy file File mgmt

A:\PGC2000

| File   | * | Size  | Date     | File | * |
|--------|---|-------|----------|------|---|
| DATA01 | P | 2304  | 94/10/31 |      |   |
| DATA02 | P | 3072  | 94/10/31 |      |   |
| DATA03 | P | 3840  | 94/10/31 |      |   |
| DATA04 | P | 3840  | 94/10/31 |      |   |
| DATA05 | P | 5120  | 94/10/31 |      |   |
| DATA06 | P | 5120  | 94/10/31 |      |   |
| DATA07 | P | 8704  | 94/10/31 |      |   |
| DATA08 | P | 12032 | 94/10/31 |      |   |
| DATA09 | P | 15360 | 94/10/31 |      |   |

[ File management(LSS ) ]

I:Dir

C:Cop [ Copy file ]

N:Ch

D:De [ To same floppy ]

File type?

**P:Program**

D:DH

I:L/O table

N:Data link table

T:Data trace

S:Instruction trace

C:Time chart moni

F:Instructions tbl

K:Expansion instr

Q:PC setup

48

3. Select the type of file that is to be copied. (For this example, "P:Program" is selected.)

C200HS <SAMPLE > Copy file    File mgmt

A:\PGC2000

| File   | * | Size  | Date     | File | * |
|--------|---|-------|----------|------|---|
| DATA01 | P | 2304  | 94/10/31 |      |   |
| DATA02 | P | 30    |          |      |   |
| DATA03 | P | 38    |          |      |   |
| DATA04 | P | 38    |          |      |   |
| DATA05 | P | 51    |          |      |   |
| DATA06 | P | 51    |          |      |   |
| DATA07 | P | 87    |          |      |   |
| DATA08 | P | 12032 | 94/10/31 |      |   |
| DATA09 | P | 15360 | 94/10/31 |      |   |

[ File management(LSS ) ]

I:Dir

C:Cop [ Copy file ]

N:Ch

D:De [ To same floppy ]

[ Same floppy ]

Enter name of base file

Enter name of new file

S:Instruction trace

C:Time chart moni

F:Instructions tbl

K:Expansion instr

Q:PC setup

4B

4. Input the name of the source file (i.e., the file that is to be copied), and press the Enter Key. To select from a list of files, press the End Key.
5. Input the destination file name and press the Enter Key. The copy operation will begin. If there is already a file with the same name, a message will be displayed asking for confirmation. To proceed with the copy operation and overwrite the existing file, input "Y" and press the Enter Key.
6. After the file has been copied, a list of files including the newly copied file will be displayed.

**Procedure 1: Copying a File to a Different Data Disk**

- 1, 2, 3... 1. Select "C:Copy file" from the LSS File Management Menu.  
 2. Select "D:To new floppy" The following screen will be displayed.

**Note** The hard disk can also be used.

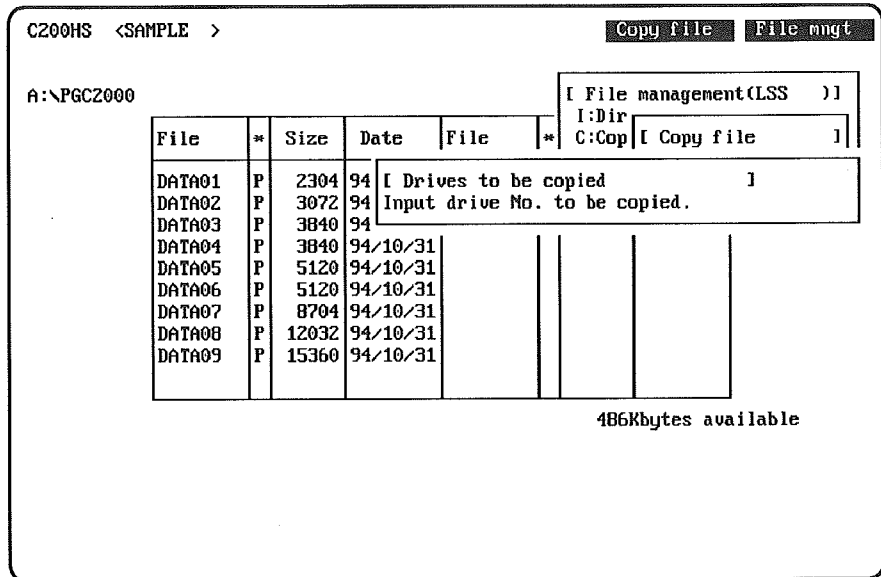

3. Input the data disk drive of the copy source file, and press the Enter Key.  
 4. Confirm that the data disk is inserted in the designated drive, and press the Enter Key. (In this example, "P:Program" is set.)

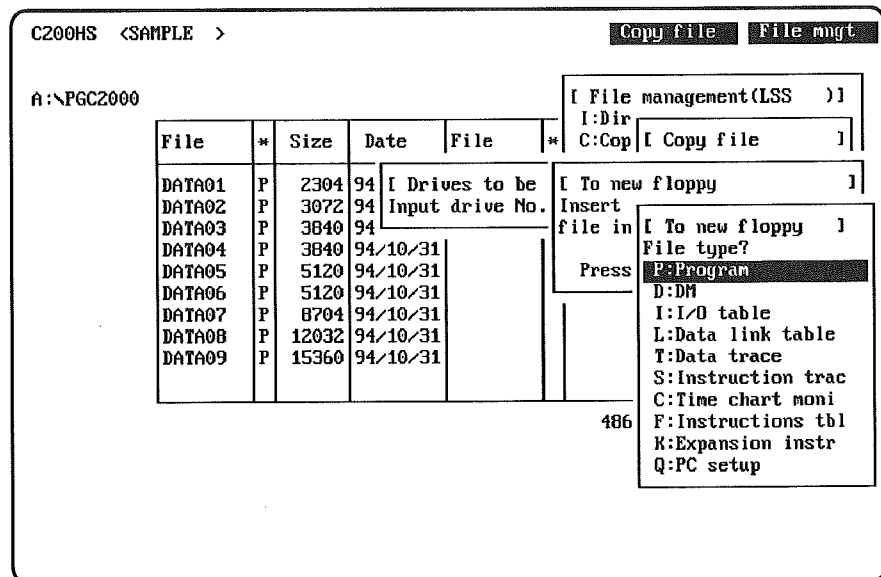

5. Input the name of the source file (i.e., the file that is to be copied), and press the Enter Key. To select from a list of files, press the End Key.  
 6. Input the destination file name and press the Enter Key. To select from a list of files, press the End Key.  
 7. Remove the data disk and insert the copy destination data disk, and then press the Enter Key. If there is already a file with the same name, a message will be

displayed asking for confirmation. To proceed with the copy operation and overwrite the existing file, input "Y" and press the Enter Key.

### 7-3-4 Changing File Names

The "N:Change file name" operation can be used to change the names of files on the data disk in the data disk drive.

- 1, 2, 3...
  1. Select "N:Change file name" from the LSS File Management Menu. The screen for selecting the file type will be displayed.
  2. Select the type of file that is to be copied. (In this example, "P:Program" is selected.)
  3. Select the file name that is to be changed. (To select from a list of files, press the End Key.)
  4. Input the new file name and press the Enter Key. The file name will be changed and a list of files, including the newly named file, will be displayed.

### 7-3-5 Deleting Files

The "D:Delete file" can be used to delete files from the data disk in the data disk drive.

- 1, 2, 3...
  1. Select "D:Delete file" from the LSS File Management Menu. The screen for selecting the file type will be displayed.
  2. Select the type of file that is to be deleted. (In this example, "P:Program" is selected.)
  3. Input the name of the file that is to be deleted, and press the Enter Key. (To select from a list of files, press the End Key.) A message will ask for confirmation.
  4. To delete the file, input "Y" and press the Enter Key. To cancel the operation, press either the Enter Key or the Escape Key.  
After the file has been deleted, a list of remaining files will be displayed.

## SECTION 8

### Option Menu

This section describes the Option Menu. Registered utility programs can be started from the Option Menu.

|     |                                     |     |
|-----|-------------------------------------|-----|
| 8-1 | Introduction .....                  | 232 |
| 8-2 | Registering a Utility .....         | 232 |
| 8-3 | Deleting a Utility .....            | 234 |
| 8-4 | Changing a Registered Utility ..... | 235 |
| 8-5 | Starting a Utility .....            | 236 |

## 8-1 Introduction

Registered utilities or MS-DOS can be started from the Option Menu. To return to SSS from DOS, input EXIT at the DOS prompt.

Up to 16 utility programs can be registered using the Option Menu. Once a utility has been registered it can be started directly from the Option Menu, which is convenient when the utility is related to SSS operation.

The SSS environment (such as modified programs or settings) is retained when a utility has been started from the Option Menu

## 8-2 Registering a Utility

Use the following procedure to register a utility program in the Option Menu.

- 1, 2, 3... 1. Select the Option Menu.

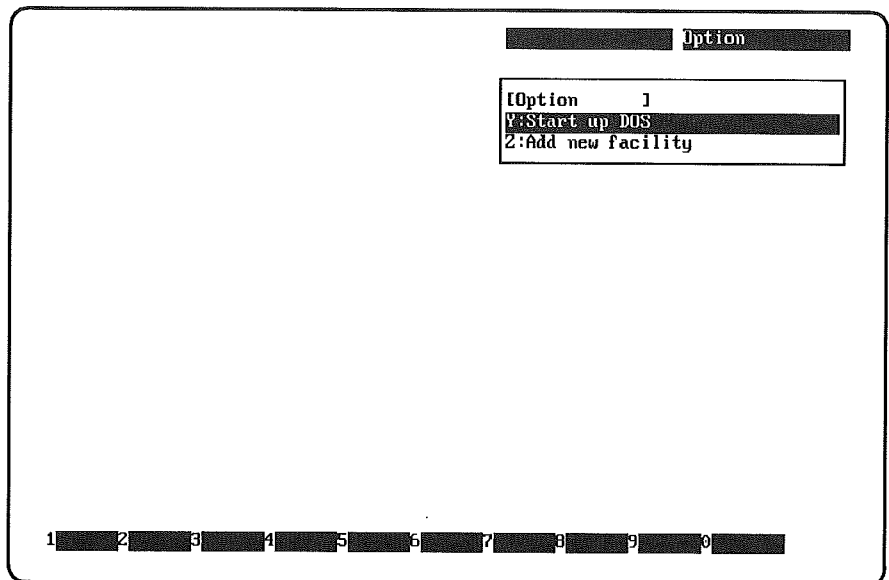



2. Select "Z:Add new facility" from the Option Menu. The utility registration display will appear.

| No | The facility name | Program name |
|----|-------------------|--------------|
| A  |                   |              |
| B  |                   |              |
| C  |                   |              |
| D  |                   |              |
| E  |                   |              |
| F  |                   |              |
| G  |                   |              |
| H  |                   |              |
| I  |                   |              |
| J  |                   |              |
| K  |                   |              |
| L  |                   |              |
| M  |                   |              |
| N  |                   |              |
| O  |                   |              |
| P  |                   |              |

1 Del 2 3 4 5 6 7 8 9 0

3. Move the cursor to the letter where the utility will be registered and press the Enter Key. Input areas for the utility name and command line will appear.
4. Input the name of the utility in the first input area and the command line of the executable program in the second input area. The utility name can be up to 30 characters long and the command line for the program can be up to 120 characters long. The utility registration can be cancelled by pressing the Escape Key.  
 For example, if the Protocol Support Software were installed in directory C:\PSS, you could input "Protocol Support Software" for the utility name. The command line would be "C:\PSS\PSS.BAT." The newly registered utility will appear in the Option Menu as shown in the following diagram.

Option

```

[Option 1
A:PROTOCOL SUPPORT SOFTWARE
Y:Start up DDS
Z:Add new facility
    
```

1 2 3 4 5 6 7 8 9 0

## 8-3 Deleting a Utility

Use the following procedure to delete a utility program from the Option Menu.

- 1, 2, 3... 1. Select the Option Menu.

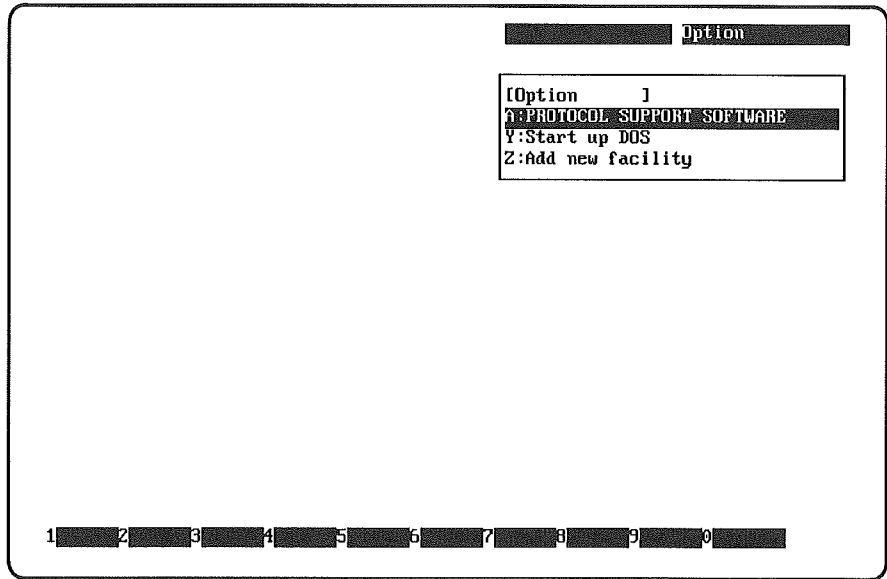

In this case, the utility program “A:Protocol Support Software” will be deleted.

2. Select “Z:Add new facility” from the Option Menu. The utility registration display will appear.

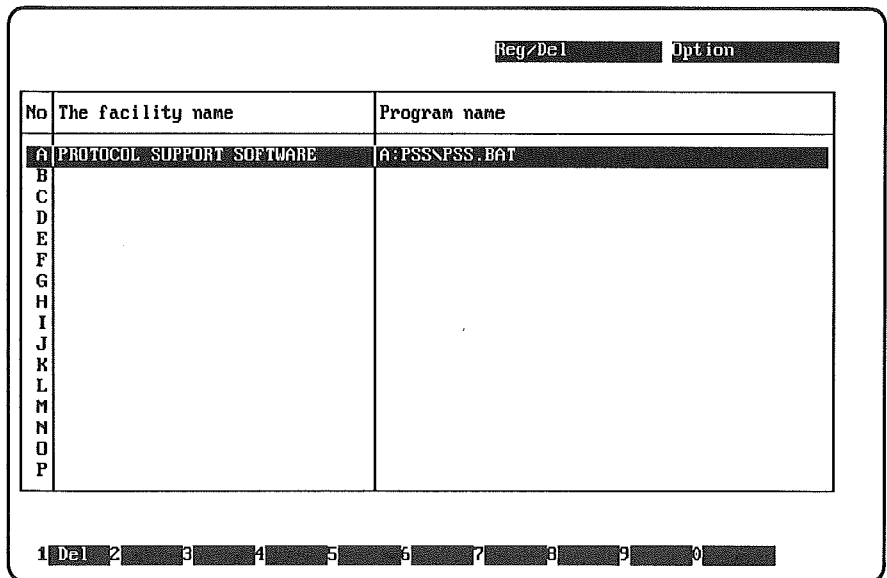

3. Move the cursor to the utility that will be deleted and press the F1 Key. A confirmation prompt will be displayed.
4. Press the Enter Key to delete the utility from the Option Menu. Enter “N” and press the Enter Key to cancel the operation.

## 8-4 Changing a Registered Utility

Use the following procedure to change the information for a utility program has been registered in the Option Menu.

- 1, 2, 3... 1. Select the Option Menu.

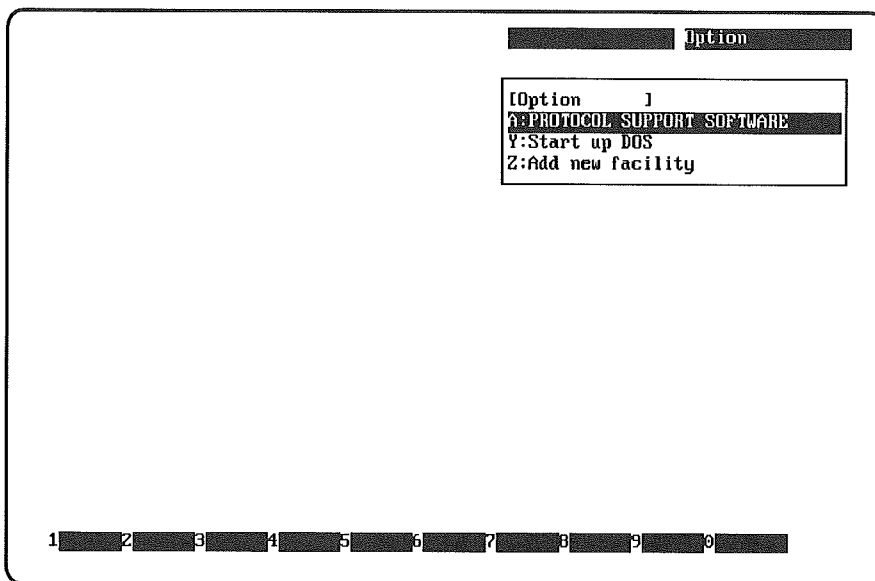

In this case, the information for the utility program “A:Protocol Support Software” will be changed.

2. Select “Z:Add new facility” from the Option Menu. The utility registration display will appear.

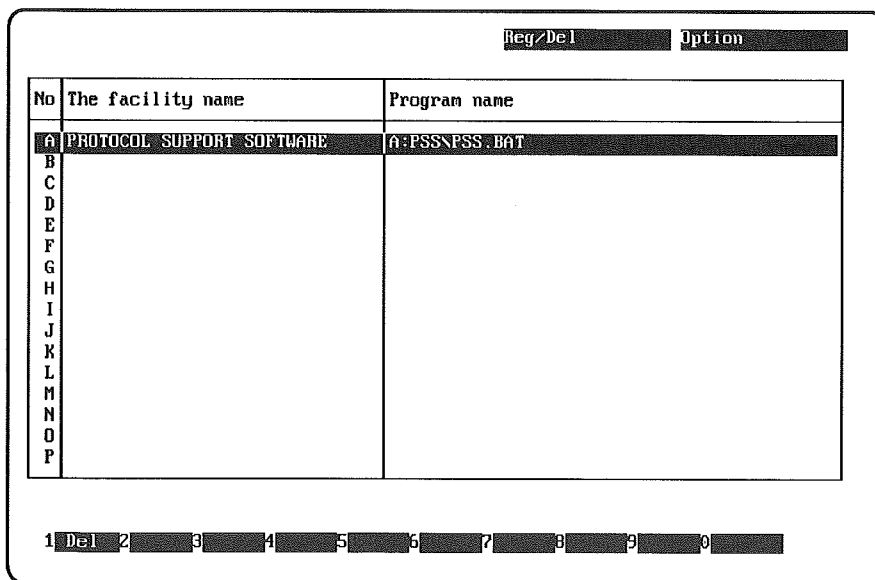

3. Move the cursor to the utility that will be changed and press the Enter Key. The input areas for the utility name and command line will appear.
4. Use the Up and Down Arrow Keys to move between the utility name and command line input areas. After changing the information in the input area, press the Enter Key to input the changes.

### 8-5 Starting a Utility

Use the following procedure to start a utility program that has been registered in the Option Menu.

- 1, 2, 3... 1. Select the Option Menu.

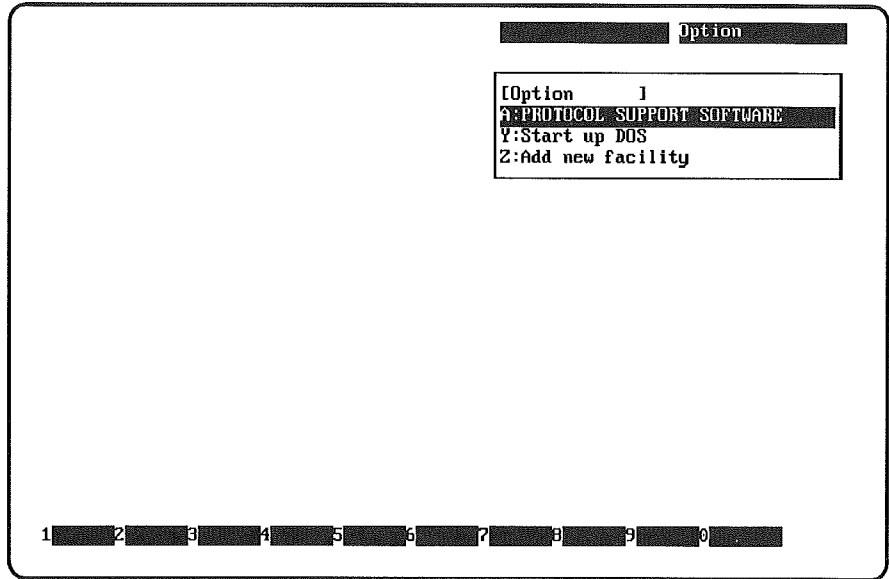

- In this case, the utility program "A:Protocol Support Software" is selected.
2. Select the utility to be started.

# Part 3

# Online Operation

This part of the manual covers procedures for operations performed online, including monitoring, program and data editing, program control, and debugging.



## SECTION 9

### Going Online

This section describes how to switch to online SSS operation. Online operation can be used to transfer programs and data between the SSS and the PC, to control and monitor PC operation, to debug the program, and to edit data and the program in the PC.

|       |                          |     |
|-------|--------------------------|-----|
| 9-1   | Preparations .....       | 240 |
| 9-1-1 | Connecting to a PC ..... | 240 |
| 9-1-2 | System Setup .....       | 240 |
| 9-2   | Going Online .....       | 241 |

## 9-1 Preparations

### 9-1-1 Connecting to a PC

The computer running the SSS must be placed online with a PC before online operations are possible. There are several methods for physically connecting the computer to a PC depending on the PC. These methods are shown in the following table. Refer to 2-4 *Connecting the SSS Computer to a PC* in the *SSS Operation Manual: Basics* for more details on these connection methods.

| Method                                      | Applicable PCs                            | Cable  |
|---|---|--|
| Direct connection via an RS-232C port       | CQM1                                      | RS-232C (provided by user)                                     |
| Direct connection via a Host Link Unit      | All but CQM1                              |  |
| Direct connection via a host link connector | CVM1                                      |  |
| Direct connection via a peripheral port     | CQM1, C200HS, CVM1                        | CQM1/C200HS: CQM1-CIF02<br>CVM1: CV500-CIF01 (with conversion) |
| Connection via a SYSMAC NET network         | C200H, C500, C1000H, C2000H, CVM1, C200HS | Refer to SYSMAC NET documentation.                             |

### 9-1-2 System Setup

The model of PC being communicated with and the PC interface must be connected before you can go online. All of these settings are performed offline on the System Setup Menu. To access this menu, select "Setup" from the top-level menu. Refer Part 2: *Offline Operation* for details.

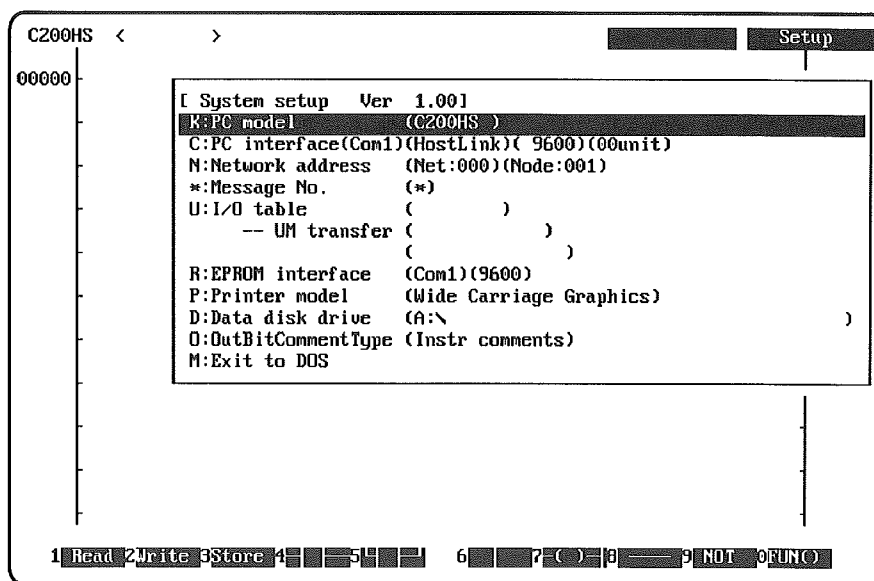



## **9-2**    **Going Online**

To go online, turn on power to the PC, connect the PC to the computer, and press Ctrl+O and then F1. The online display will appear. The menus along the top of the screen will display the current operating mode of the PC, the current operation, and information on the PC connection, such as the host link number, the network/node number, etc. The PC connection information that is displayed depends on the PC model and PC interface being used.

**Note** You cannot switch between online and offline operation while the File Management or System Setup Menus are being displayed. You also cannot go online when in the mnemonic display mode.



# SECTION 10

## Monitoring

This section describes the operations used to transfer the program between the computer and PC, to monitor program execution in the PC, and to edit programs online.

|          |   |     |
|----------|---|-----|
| 10-1     | Monitoring                                  | 244 |
| 10-2     | Monitoring Displays                         | 244 |
| 10-2-1   | Displaying the Online Menu                  | 245 |
| 10-2-2   | Function Keys                               | 245 |
| 10-3     | Transferring Programs                       | 246 |
| 10-3-1   | Transferring the Program to the PC          | 247 |
| 10-3-2   | Transferring the Program to the Computer    | 252 |
| 10-3-3   | Comparing Programs (Verify)                 | 254 |
| 10-4     | Clearing Data Areas                         | 255 |
| 10-5     | Searching in Ladder Diagrams                | 257 |
| 10-5-1   | Searching for Instructions                  | 257 |
| 10-5-2   | Searching for I/O Comments                  | 257 |
| 10-5-3   | Searching for Block Comments                | 257 |
| 10-5-4   | AI Searches                                 | 258 |
| 10-6     | Changing the Display Mode                   | 260 |
| 10-6-1   | Changing Set Values                         | 260 |
| 10-7     | Pause                                       | 265 |
| 10-8     | Differential Monitor                        | 269 |
| 10-9     | Clearing Errors                             | 271 |
| 10-10    | Monitor Data Operations                     | 271 |
| 10-10-1  | Monitor Data Display                        | 272 |
| 10-10-2  | Function Key Operations                     | 272 |
| 10-10-3  | Specifying Words and Bits                   | 273 |
| 10-10-4  | Monitoring Example                          | 273 |
| 10-10-5  | Changing to ASCII Format                    | 276 |
| 10-10-6  | Clearing the Monitor Data Display           | 277 |
| 10-10-7  | Force-setting/Force-resetting Single Bits   | 278 |
| 10-10-8  | Force-setting/Force-resetting Multiple Bits | 280 |
| 10-10-9  | Releasing Force-set/Force-reset Bits        | 282 |
| 10-10-10 | Changing Present Values                     | 284 |
| 10-10-11 | Pause                                       | 286 |
| 10-11    | Online Editing                              | 286 |
| 10-11-1  | Online Editing Procedure                    | 287 |
| 10-11-2  | Online Editing Example                      | 288 |
| 10-12    | Reading the Cycle Time                      | 290 |
| 10-13    | Displaying Memory Usage                     | 290 |

## 10-1 Monitoring

Basically speaking, monitoring means to show the operating status of the ladder diagram program on the SSS display. Monitoring allows you to do the following:

- Examine the program visually on the monitor displays.
- Control the status of I/O bits and other bits used in the program to simulate actual system inputs and outputs.
- Debug the program before actually attempting to operate the system.
- Modify the program in the PC directly from the SSS (online editing) to implement required changes onsite.
- Search the program.

**! Caution** The program in the PC and the program in the system work area of the SSS must be the same to be able to monitor or edit the program in the PC. Use the program transfer operation before starting monitoring or online editing operations if necessary to ensure that the two programs are the same.

**! Caution** Never use an incorrect program. Never change to a different program without first confirming operation and safety. Depending on the controlled system, an incorrect or inappropriate program can have serious and unexpected results.

## 10-2 Monitoring Displays

Once you are online, press the End Key to display the Online Menu and press Enter. The basic monitoring display will appear showing the program. You can use the PageUp and PageDown Keys to move through the program.

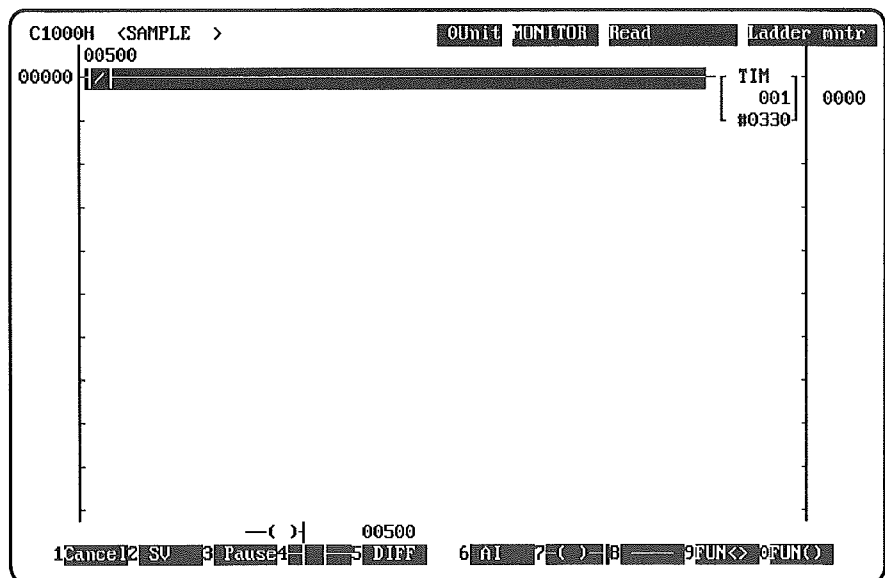

**Note** The cursor display can be turned ON and OFF by pressing Ctrl+A.

## 10-2-1 Displaying the Online Menu

Press the End Key from the basic monitor display to access the following Online Menu. This menu is used to monitor the operating status of a PC communicating with the computer. The status of bits, words, timers, and counters can be monitored and manipulated. This menu is also used to display the PC cycle time, to change the user program in the PC, to search for instructions, and to manage I/O and block comments.

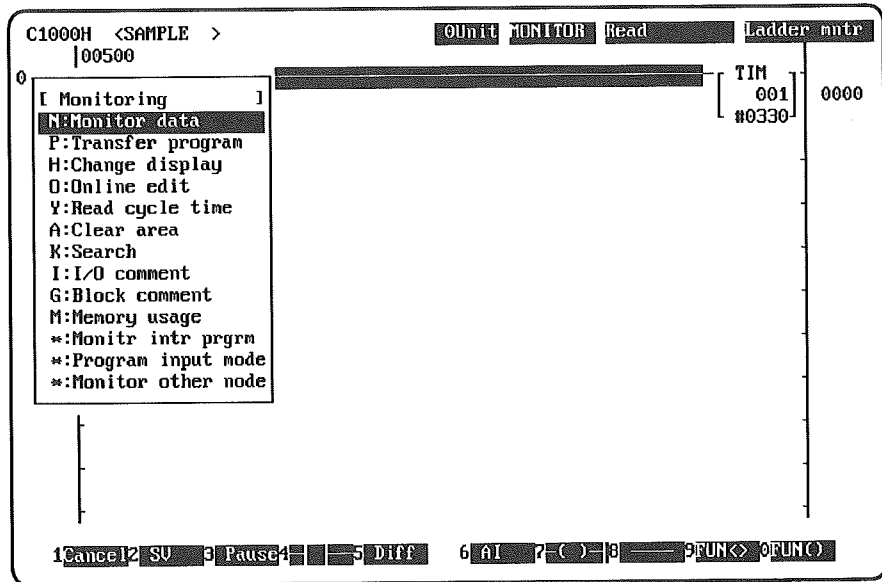

**Valid PC Modes** The following table shows the PC modes in which each operation can be executed.

| Operation          |                        | RUN | MONITOR | PROGRAM |
|--------------------|------------------------|-----|---------|---------|
| N:Monitor data     |                        | OK  | OK      | OK      |
| P:Transfer program | R:PC → Computer        | OK  | OK      | OK      |
|                    | W:Computer → PC        | No  | No      | OK      |
|                    | V:Verify               | OK  | OK      | OK      |
| H:Change display   | L:Ladder diagram       | OK  | OK      | OK      |
|                    | C:Ladder with comments | OK  | OK      | OK      |
| O:Online edit      |                        | No  | OK      | OK      |
| Y:Read cycle time  |                        | OK  | OK      | No      |
| A:Clear data areas |                        | No  | No      | OK      |
| K:Search           |                        | OK  | OK      | OK      |
| I:I/O comment      |                        | OK  | OK      | OK      |
| G:Block comment    |                        | OK  | OK      | OK      |
| M:Memory usage     |                        | OK  | OK      | OK      |

## 10-2-2 Function Keys

The PC's mode can be changed between MONITOR, PROGRAM, and RUN by using Ctrl+O followed by F2 (RUN), F3 (MON), and F4 (PRGM). Other function keys from the monitoring display are described below.

**Caution** Never change the PC's operating mode without first confirming that there will be no problems in the controlled system. Depending on the controlled system, performing any of these operations can have serious and unexpected results.

- F1: Cancel** The F1 Key is used to clear errors. Refer to *10-9 Clearing Errors* for details.
- F2: SV** The F2 Key can be used to change the set values of timers and counters. Refer to *10-6-1 Changing Set Values* for details.
- Note** F2 cannot be used to change set values while the PC is in RUN mode.
- F3: Pause** The F3 Key is used to pause monitoring of the PC. Program execution in the PC, however, will continue. Refer to *10-7 Pause* for details.
- F4: ↑ ↓** The F4 Key is used to search for input conditions including the following instructions: LD, LD NOT, AND, AND NOT, OR, and OR NOT.
- F5: Diff** The F5 Key can be used to monitor a bit and detect when the bit goes from OFF to ON or from ON to OFF. This operation is supported by the CQM1 and C200HS only. Refer to *10-8 Differentiation Monitor* for details.
- F6: AI** AI searches are used in debugging to find the condition that is the most likely cause of an output not turning ON. Refer to *10-5-4 AI Searches* for more details.
- F7: ( ) ← →** The F7 Key is used to search for OUTPUT instruction, but also searches for OUT NOT, SET, and RSET instructions.
- F9: FUN<>** The F9 Key is used to search for block programming instructions. This key is not displayed for the CQM1 or C200HS.
- F10: FUN()** The F10 Key is used to search for special instructions through their function codes.
- Shift+F8: SET** Shift+F8 is used to search for the SET instructions, but also searches for OUT, OUT NOT, and RSET instructions. This operation is supported by the CQM1 and C200HS only.
- Shift+F9: RSET** Shift+F9 is used to search for the RSET instructions, but also searches for OUT, OUT NOT, and SET instructions. This operation is supported by the CQM1 and C200HS only.
- Other Function Keys** The rest of the Function Keys are used to specify instructions or bits when searching and are described under relevant search operation later in this section.

## 10-3 Transferring Programs

The Transfer Program operations can be used to transfer or compare programs between the computer and the PC. The following table shows the operations that can be selected from the Transfer Program menu. These operations are described in detail later in this section.

 **WARNING** Never transfer programs to other nodes, change I/O memory at other nodes, or perform any other operations at other nodes without first confirming that the results of the action will not create a dangerous situation. Depending on the controlled system, changes to programs or data can result in serious injury or death.

| Operation       | Function  |
|-----------------|---|
| R:PC → Computer | Transfers the program, I/O table, data link table, and instructions table from the PC to the system work area of the computer.<br>With the C200HS, C200HX/C200HG/C200HE the I/O comments and fixed DM area can also be transferred. |
| W:Computer → PC | Transfers the program, I/O table, data link table, and instructions table from the system work area of the computer to the PC.<br>With the C200HS, C200HX/C200HG/C200HE the I/O comments and fixed DM area can also be transferred. |
| V:Verify        | Compares the PC's program, I/O table, data link table, and instructions table to the ones in the system work area of the computer.  |

The program on the computer is handled in intermediate code and the PC's program is handled in machine language, so one or the other must be converted for data transfer or comparison. A message will flash on the display while this conversion is being performed.

Program transfer or comparison can be interrupted by pressing the Escape Key. The operation will be aborted after the block being processed is completed.

**Tables**

The I/O table and data link table will be transferred with the program if this setting is made under "U:I/O table—UM transfer" in the System Setup. The I/O table and data link table will be written to the appropriate locations in the PC when the PC is turned on.

When the data link table is transferred for a C1000H/C2000H SYSMAC NET Link System with 2 operating levels, only operating level #1's data will be transferred. Refer to "U:I/O table—UM transfer" in the System Setup for more details.

The tables and data that can be transferred/compared depend on the PC model, as shown in the following table.

| PC Models                              | Tables                     |
|--|----------------------------|
| C120, C200H, C500, C1000H              | I/O table, data link table |
| CQM1, C200HS, C200HX/<br>C200HG/C200HE | Instructions table         |
| C200HS, C200HX/<br>C200HG/C200HE       | Fixed DM, I/O comments     |

**10-3-1 Transferring the Program to the PC**

This operation can be used to transfer the program, I/O table, data link tables, and instructions table from the system work area of the computer to the PC.

This operation is possible only when the PC is in PROGRAM mode.

With the C200HS, C200HX/C200HG/C200HE the I/O comments and fixed DM area can also be transferred. With the CQM1 and C200HS, C200HX/C200HG/C200HE the instructions table can also be transferred.

Any instructions which contain operand errors or contain "???" during the program check are converted to NOP(00).

**General Procedure**

The following procedure applies to all PCs except the C200HS, C200HX/C200HG/C200HE.

- 1, 2, 3... 1. Select "P:Transfer program" from the Online Menu.

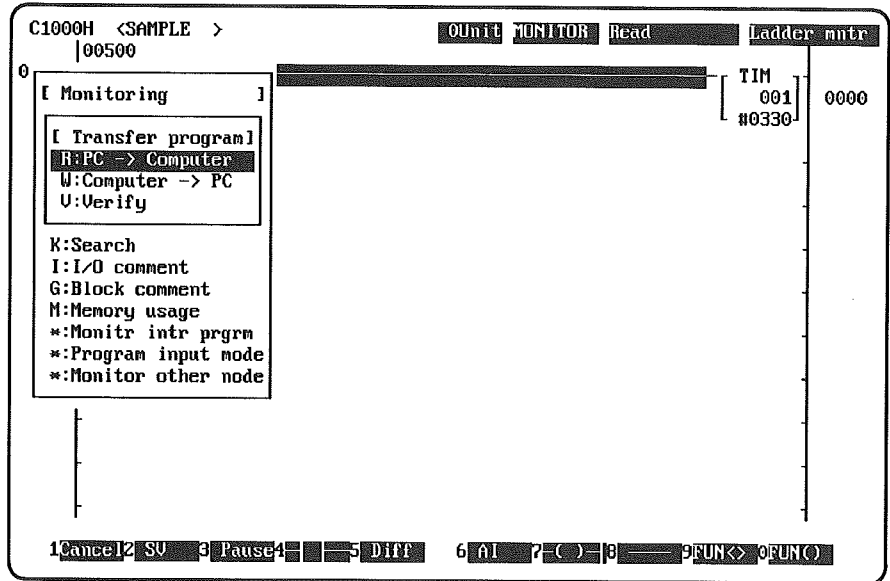

2. Select "W:Computer → PC" from the Transfer Program Menu. The following menu will appear.

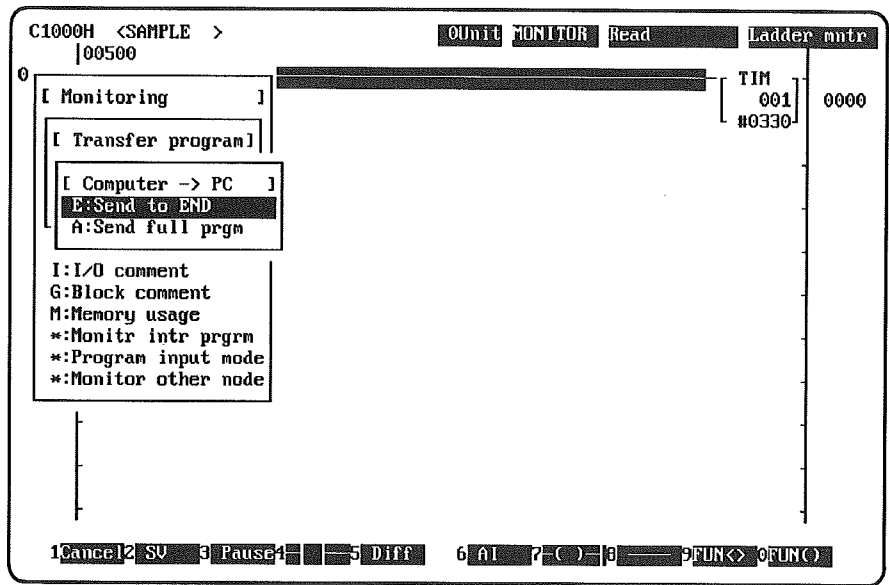



- Specify whether to transfer the entire program or the section up to the first END instruction. The following confirmation prompts will appear. Press Enter to proceed with these settings.

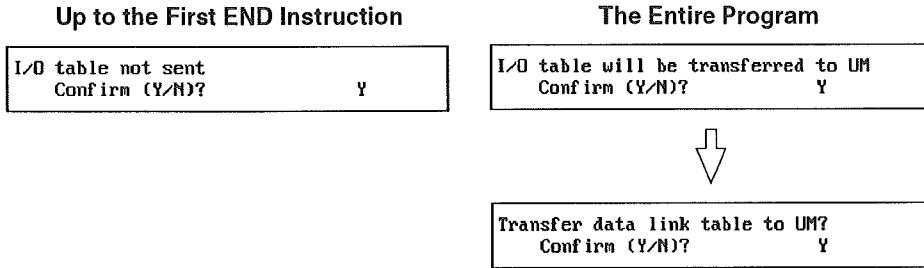

- The program transfer will begin when Enter is pressed. A status bar will appear showing the approximate amount transferred and the amount remaining to be transferred.

The program transfer can be interrupted by pressing Escape. The program data transferred up to that interruption will remain in the PC and all remaining program addresses in the PC will contain NOP(00).

- With the CQM1, the instructions table will be transferred after the program. A warning message will be displayed if pin 4 of the PC's DIP switch is OFF (designating the default instructions table). If this warning is displayed, turn pin 4 of the PC's DIP switch ON and transfer the program again. The following message will be displayed if a C200HS/C200HX/C200HG/C200HE/CQM1 program is used.

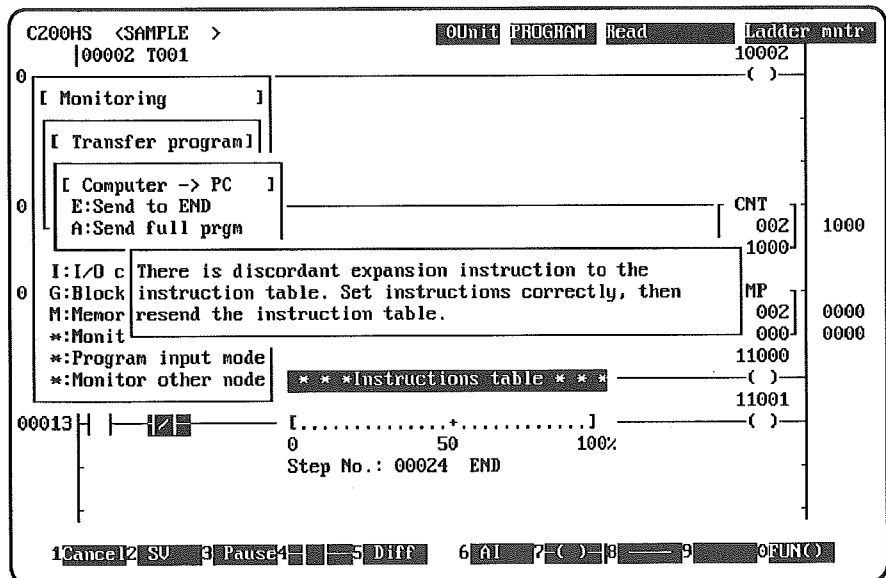

This message can be ignored if expansion instructions aren't being used. (Press Escape to clear the message.)

If expansion instructions are being used, make the appropriate instructions table for the PC model and transfer the program again.

**C200H Procedure**

The following procedure applies to the C200HS and C200HX/HG/HE PCs.

- 1, 2, 3... 1. Select "P:Transfer program" from the Online Menu.

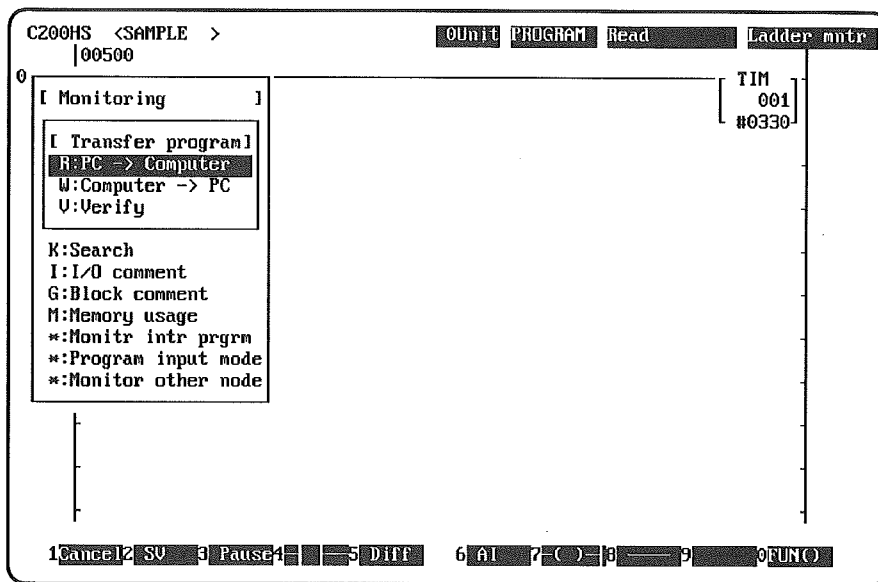

2. Select "W:Computer → PC" from the Transfer Program Menu. Proceed to step 5, if the UM Area Allocation settings aren't being used.

The following display will appear if the UM Area Allocation settings have been made for the first time or changed.

This display will not appear if the UM Area Allocation settings are being used, but haven't been changed. Proceed to step 4.

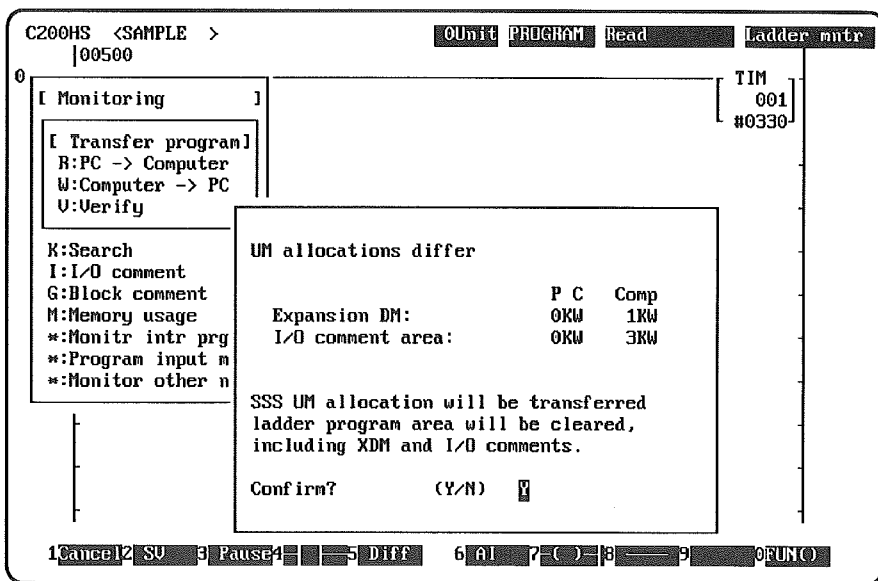

3. Specify whether the UM Allocation in the computer is to be used.  
 Enter "Y" if you want the UM Allocation in the computer to be used in the PC. The program and data in the PC will be cleared if the UM Allocation in the SSS is used.  
 or Enter "N" if you don't want to change the PC's UM Allocation. The Online Menu will be displayed. Use the ALLOCATE UM operation to change the computer's UM Allocation so it matches the PC's. Refer to 5-14 *Allocating UM* for details.

- Specify whether or not to transfer the Fixed DM area and/or I/O comments. Proceed to step 5, if the displayed settings are correct.

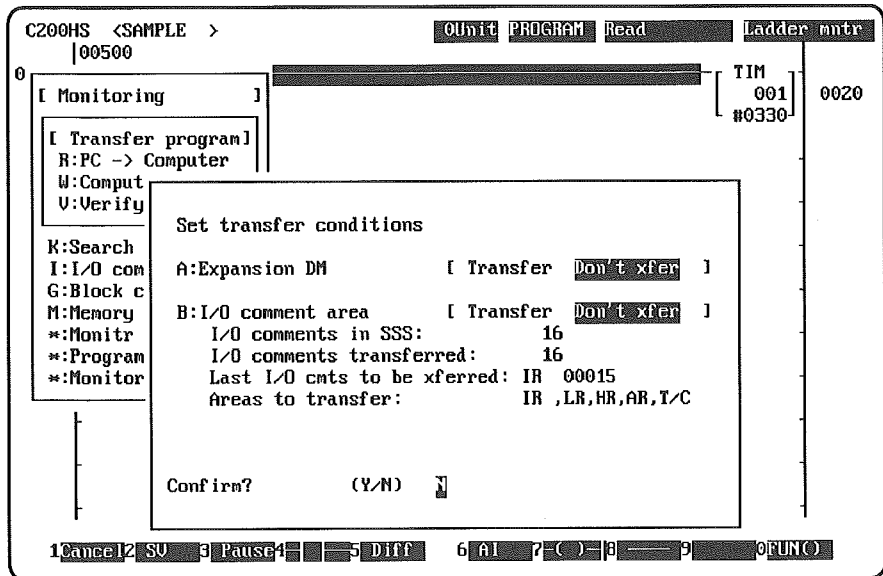

If an asterisk is displayed for an item, the item hasn't been set in the computer's UM Allocation, so it cannot be selected.

- After setting the necessary parameters, move the cursor to the confirmation prompt and enter "Y" to begin the program transfer.

If the UM size set in the computer's UM Allocation exceeds the capacity of the PC, the following error message will be displayed. In this event, press Escape to exit the Transfer Program operation, execute the reallocate UM to reduce the size of the UM so it doesn't exceed the size of the PC's UM, and try transferring the program again. Refer to 5-14 *Allocating UM* for details.

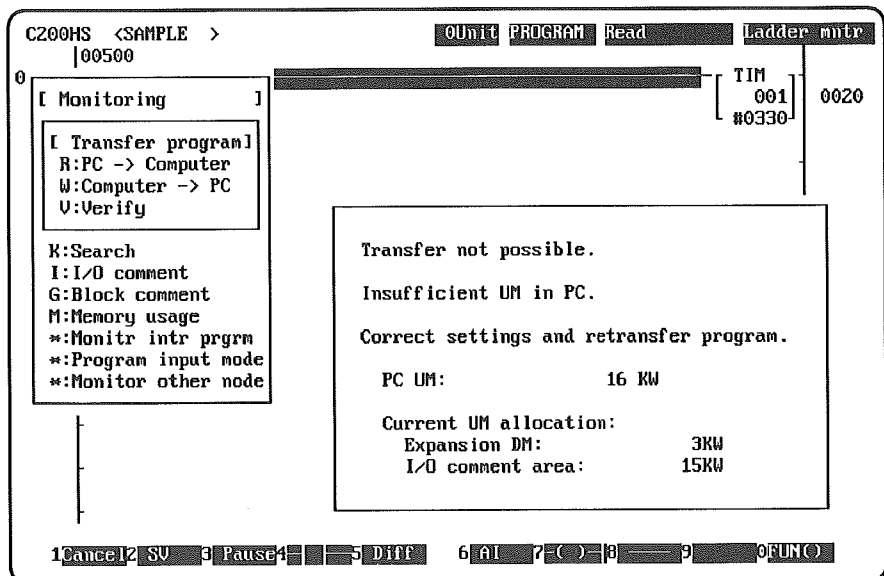

- Specify whether to transfer the entire program or the section up to the first END instruction. The program transfer will begin when Enter is pressed. A status bar will appear showing the approximate amount transferred and the amount remaining to be transferred.

The program transfer can be interrupted by pressing Escape. All remaining program addresses in the PC will contain NOP(00).

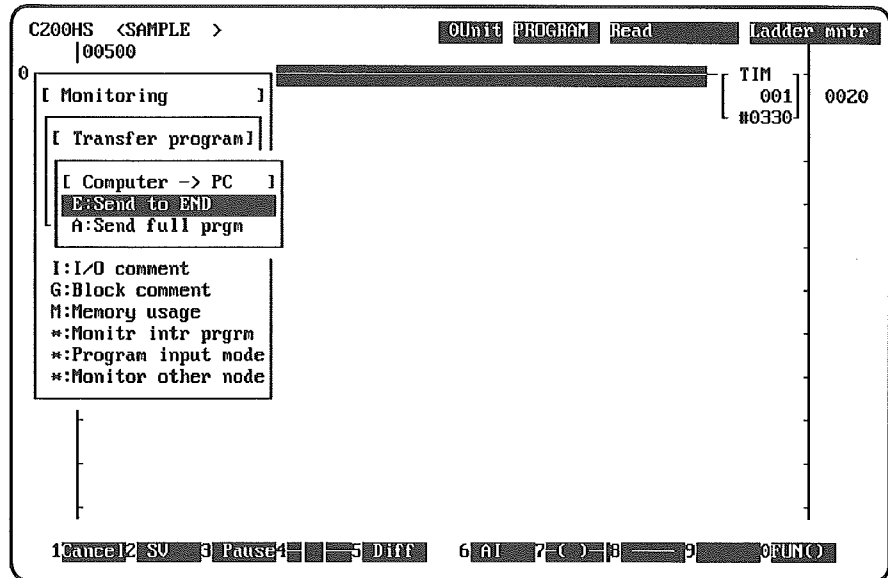

The instructions table will be transferred after the program.

A warning message will be displayed if pin 4 of the PC's DIP switch is OFF (designating the default instructions table). If this warning is displayed, turn pin 4 of the PC's DIP switch ON and transfer the program again.

Another warning message will be displayed if a C200HS/CQM1 program is used. Refer to step 5. on page 249 for details on handling this error.

### 10-3-2 Transferring the Program to the Computer

This operation can be used to transfer the program, I/O table, data link table, and instructions table from the PC to the system work area of the computer.

**I/O Comments** With the C200HS, C200HX/C200HG/C200HE the I/O comments area can be transferred with the program. If there are I/O comments in both the computer and C200HS, C200HX/C200HG/C200HE either set of I/O comments can be used. A selection prompt will appear when the program is transferred.

For PCs other than the C200HS, C200HX/C200HG/C200HE the I/O comments in the computer are linked to the program when the program is transferred. If the I/O comments in the computer don't match the program being transferred, those I/O comments can be erased beforehand with the offline Clear Memory operation or the PC's I/O comments can be retrieved afterwards with the Retrieve Comments operation.

If you need to transfer only the fixed DM area, refer to the online DM Menu.

**Note** If the computer contains the I/O comments for the program in the PC, the program can be monitored while displaying the comments. Online editing can then be used to overwrite not only the program, but also the comments, and the program will be saved with the comments, eliminating the need to retrieve comments separately.

#### Transferring the Program

The following procedure shows how to transfer the program from the PC to the computer.

- 1, 2, 3... 1. Select "P:Transfer program" from the Online Menu.
2. Select "R:PC → Computer" from the Transfer Program Menu.

3. Select "E: Send to END" form the menu to transfer the program up to the first END instruction. The following confirmation prompt will appear.

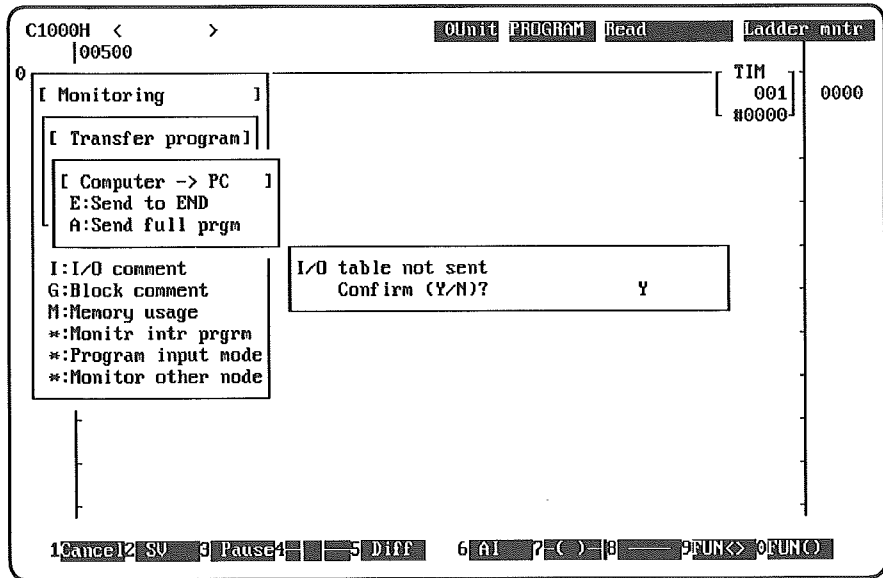

4. Enter "Y" to begin transferring the program. The program will be converted to intermediate code automatically after it is transferred.

With the CQM1 and C200HS, C200HX/C200HG/C200HE the instructions table will be transferred after the program.

If the PC contains data in a format that can't be processed by SSS, the data transfer will be interrupted and the following message will be displayed:

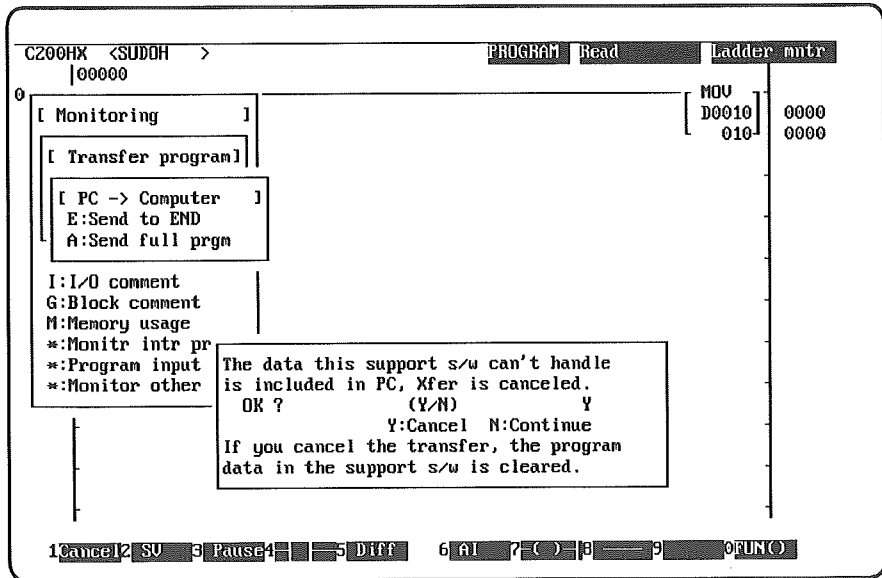

If this message is displayed, press Enter to cancel the transfer and return to the monitoring display or press "N" and Enter to restart the transfer.

**Note** The ladder program may be displayed unexpectedly if data that can't be processed by the SSS is transferred. In this case, execute the offline memory clear operation.

- With the C200HS, C200HX/C200HG/C200HE the following message will be displayed if there are I/O comments in both the computer and the PC. Enter "Y" to transfer the I/O comments to the computer. Enter "N" to cancel the transfer of I/O comments.

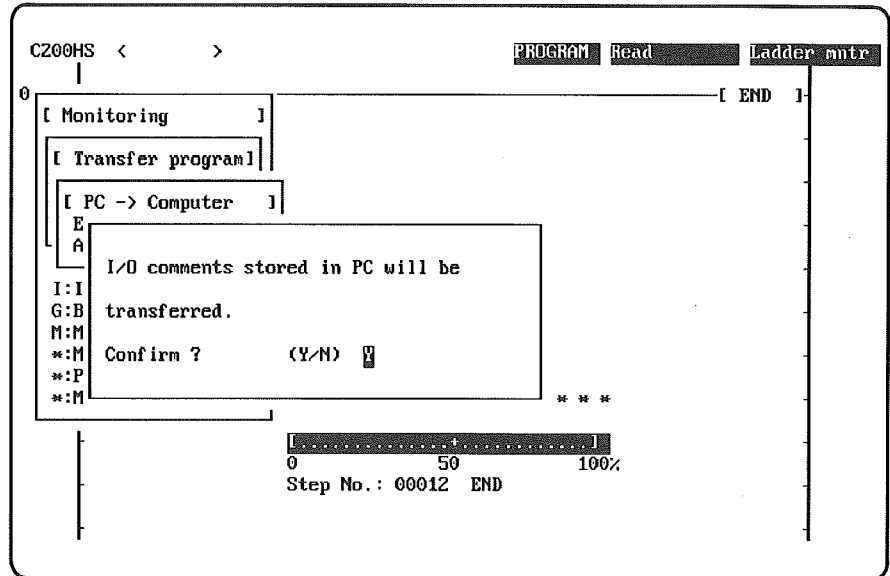

**Note** Do not transfer the I/O comments from a C200HS, C200HX/C200HG/C200HE PC if you want to use the I/O comments stored in SSS.

**Transferring the Program and Tables**  
1, 2, 3...

The following procedure shows how to transfer the program, I/O table, and data link table from the PC to the computer.

- Select "P:Transfer program" from the Online Menu.
- Select "R:PC → Computer" from the Transfer Program Menu.
- Select "A:Send full prgm" form the menu to transfer the entire program. Program transfer will begin automatically.
- The following confirmation prompt will be displayed when the I/O table and data link table are being written to UM. Enter "Y" to transfer each item. Enter "N" to cancel the transfer of that item.

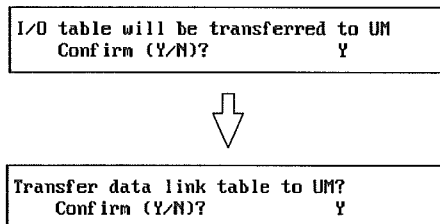

- Specify whether or not to transfer I/O comments and press Enter. The program will be converted automatically.

**10-3-3 Comparing Programs (Verify)**

This operation can be used to compare the program, I/O table, data link table, and instructions table in the PC and the system work area of the computer.

**Note** The I/O comments in the computer are not compared to those in the PC, even with the C200HS, C200HX/C200HG/C200HE.

**Procedure** The following procedure shows how to compare the programs in the PC and computer.

- 1, 2, 3...
1. Select "P:Transfer program" from the Online Menu.
  2. Select "V:Verify" from the Transfer Program Menu. A prompt will appear.
  3. Select "A:All" to compare the entire program, including the I/O table, data link table, and instructions table or "E: To END" to compare just the program.

**Up to the First END Instruction**

|  |   |
|--|---|
| I/O table not verified<br>Confirm (Y/N)? | Y |
|--|---|

**The Entire Program**

|  |   |
|--|---|
| I/O table will be verified with UM<br>Confirm (Y/N)? | Y |
|--|---|



|  |   |
|--|---|
| Data link will be verified with UM<br>Confirm (Y/N)? | Y |
|--|---|

4. Specify whether the I/O table and data link table should be compared and enter "Y" to begin converting and comparing the programs. The comparison can be interrupted by pressing Escape.  
The number of addresses being compared is counted and the progress of the comparison will be displayed as a percentage.
5. If the programs are identical, the message "Verified" will be displayed.  
or If differences are found, the program addresses where they occur will be displayed. Other messages will indicate whether differences were found in the I/O table, data link table, and instructions table.  
If the PC contains data in a format that can't be processed by SSS, the data comparison will be interrupted and an error message will be displayed.  
If the error message is displayed, press any key to return to the monitoring display.

## 10-4 Clearing Data Areas

The Clear Data Areas operation can be used to clear data areas in the PC. The AR, HR, TIM/CNT, and DM data areas can be cleared. Data in the computer's system work area will not be affected.

This operation is possible only when the PC is in PROGRAM mode.

**Caution** If the DM area is cleared in the CQM1, the PC Setup parameters will be returned to their default settings.

- 1, 2, 3...
1. Select "A:Clear data areas" from the Online Menu. The following display will appear. (With the C200HS, the Expansion DM Area (XDM) will be displayed too.)

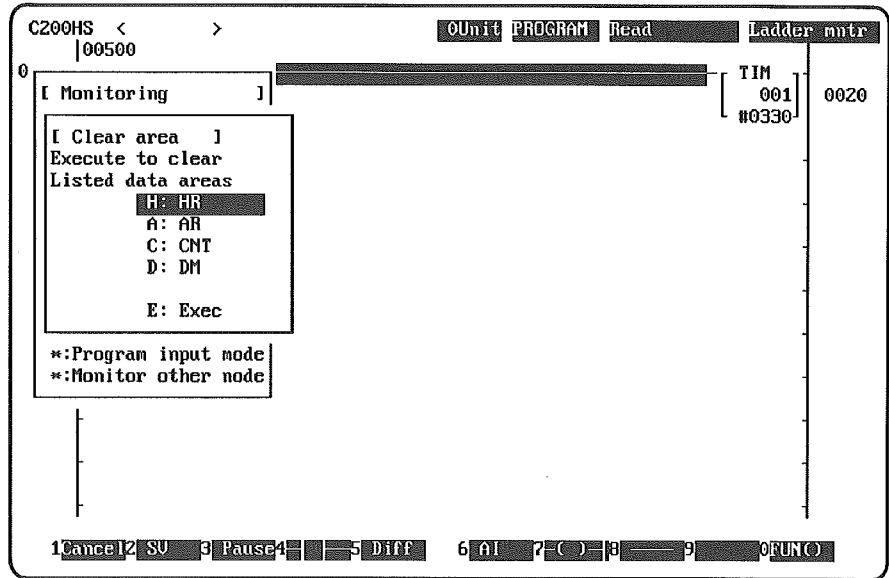

2. The data areas listed on-screen when the operation is executed will be cleared. Remove any data areas that you do not want to clear by selecting them and pressing Enter.

In the following example, the AR and TIM/CNT areas will be cleared.

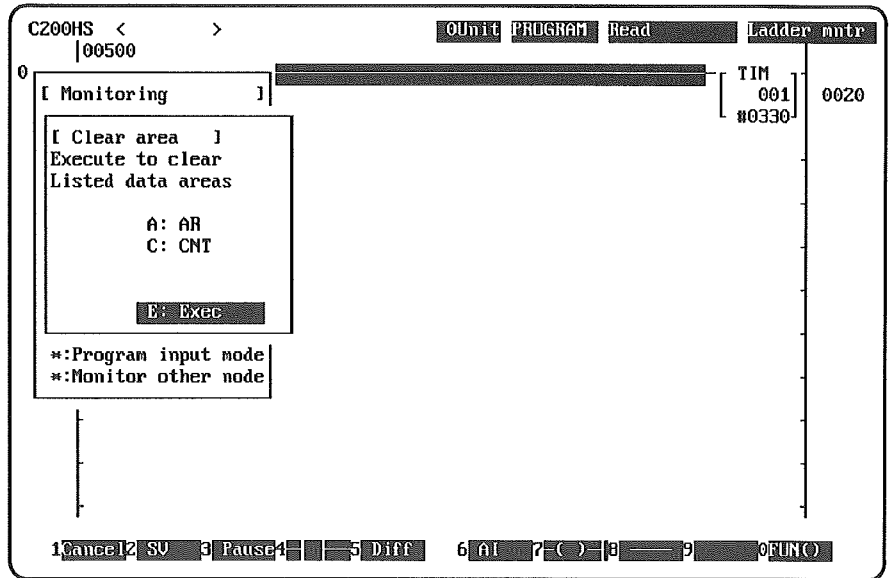

3. When the data areas that are not to be cleared have been removed, select "E:Exec" and press Enter.

The progress of the operation will be displayed as a percentage.



## 10-5 Searching in Ladder Diagrams

The Search Instruction, I/O Comment, and Block Comment operations can be used to find particular instructions and comments in the PC program. If the PC is in RUN or MONITOR mode, program status will also be displayed.

Before searching for an instruction or comment, monitor the PC program in online mode. You can scroll through the program using the PageUp and PageDown Keys. The Up and Down Cursor Keys can be used to scroll through instruction blocks.

The ON/OFF status of program blocks can also be displayed when the PC is in RUN or MONITOR mode, although the CQM1 does not support the FUN<> function for F9.

### 10-5-1 Searching for Instructions

- 1, 2, 3...**
1. Monitor the ladder program.
  2. Select "K:Search" from the Online Menu.
  3. Enter "Y" to proceed with the search,  
or "N" to correct the search parameters.  
Input the instruction you want to find using the number keys and then input the program address where you want the search to begin.
  4. If the instruction is found, the instruction block and the specified instruction will be displayed. Press Enter to search for the next occurrence of the instruction

### 10-5-2 Searching for I/O Comments

The I/O Comment operation is used to search for specified I/O comments in the PC's program.

- 1, 2, 3...**
1. Monitor the ladder program.
  2. Select "H:Change display" from the Online Menu and switch to ladder with comments format.
  3. Select "I:I/O comment" from the Online Menu.
  4. Input the comment you want to find using the alphanumeric keys. Up to 16 characters can be input. It is not necessary for the entire comment to be input as all characters are searched.
  5. Press Enter. The program will be searched for the given I/O comment. If found, the instruction block and the specified comment will be displayed.
  6. Press the Escape Key to return to monitor mode or press Enter again to continue searching subsequent addresses.

### 10-5-3 Searching for Block Comments

The Block Comment operation is used to read through the program searching for block comments.

This operation searches for specified block comments in the PC's program. It functions in a similar fashion to the offline searches.

- 1, 2, 3...**
1. Monitor the ladder program.
  2. Select "H:Change display" from the Online Menu and switch to ladder with comments format.
  3. Select "G:Block comment" from the Online Menu.
  4. Input the comment you want to find using the alphanumeric keys. Up to 16 characters can be input. It is not necessary for the entire comment to be input as all characters are searched.
  5. Press Enter. The program will be searched for the given I/O comment. If found, the instruction block and the specified comment will be displayed.

- Press the Escape Key to return to monitor mode or press Enter again to continue searching subsequent addresses.

### 10-5-4 AI Searches

The AI search is used to determine which execution condition is preventing an output from going ON. The cursor is automatically moved to the execution condition that is most likely to be the cause.

The following instructions can be searched: LD, LD NOT, AND, AND NOT, OR, OR NOT. AI searches are triggered by specifying OUT or OUT NOT instructions. The search can fail if the output bit being searched is in an interlocked (IL/ILC) or jumped (JMP/JME) program section and the program section is not executed.

#### Procedure

The following procedure shows how to perform an AI search.

1, 2, 3...

- Press F6 while monitoring. The message "AI Mon/Comm" will be displayed in the upper-right corner of the display.
- Input the output bit address that you want to check and press Enter.  
If the desired output bit is found, the cursor will be moved automatically to the execution condition that is most likely to be preventing activation.
- Press Enter again if you want to continue searching for the output bit.

If the execution condition identified by AI search isn't the cause of the problem, move the cursor to another condition in the instruction block and press Enter. If the suspected condition isn't displayed on-screen, use the PageUp and PageDown Keys to display it.

The Tab Key can be pressed to switch the display between the last program address that was found by the AI search and the current address. Using the Tab Key can speed-up the debugging process.

#### Example

The following example shows AI search used to find the execution condition preventing output bit IR 01000 from turning ON in the following program.

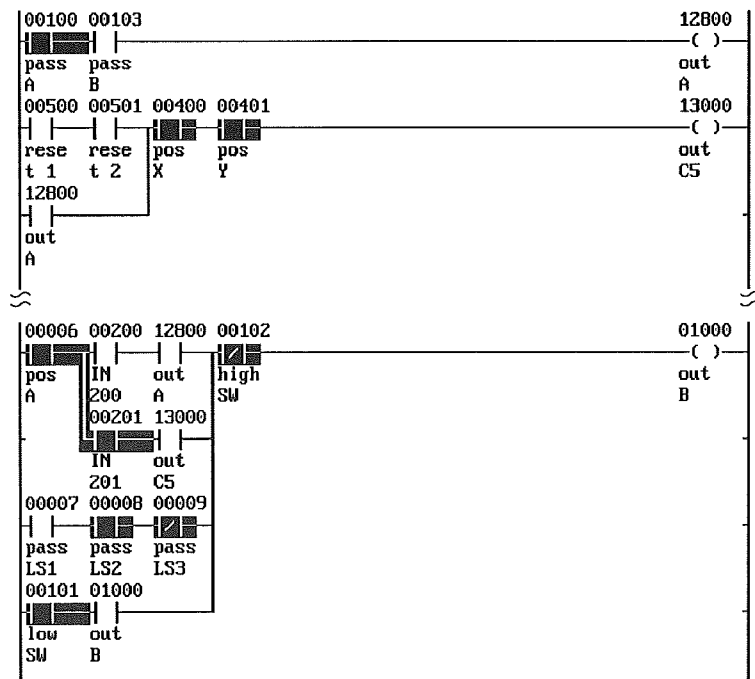

- 1, 2, 3... 1. Specify the output bit by inputting F6, F7, 1000, and Enter. The instruction block containing the output IR 01000 will be displayed and the cursor will move to IR 13000, the suspected cause of the problem.

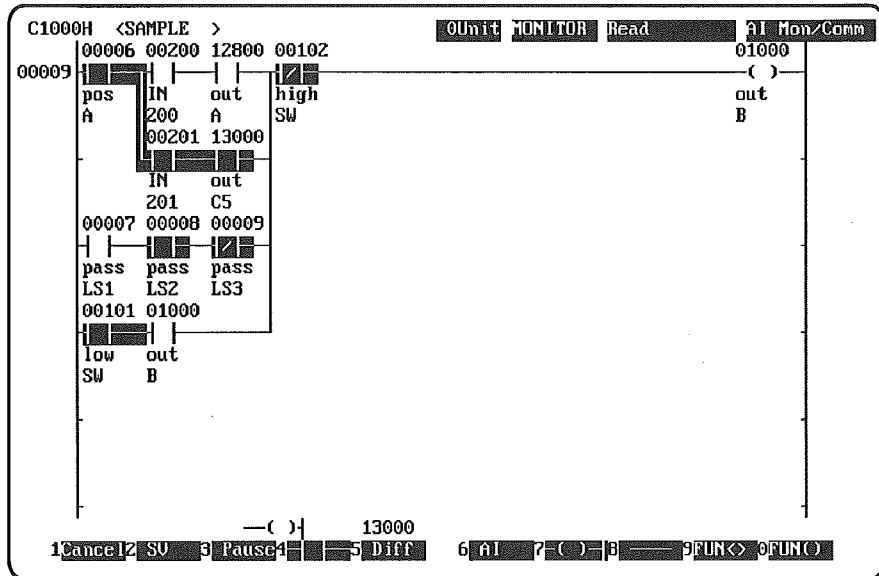

In this example, the cause of the problem could be IR 13000, IR 12800, or IR 00007. IR 13000 was judged to be the most likely cause, so the cursor was moved to this position.

**Note** Self-maintaining bits (e.g., the use of IR 01000 as in input condition in the above program) are not considered by the AI Search operation.

2. If the execution condition at the cursor is the cause of the problem, press Enter again. The next instruction block will be searched and the cursor will be moved to the execution condition that seems to be preventing the output from going ON. In this case the cursor is moved to IR 12800.

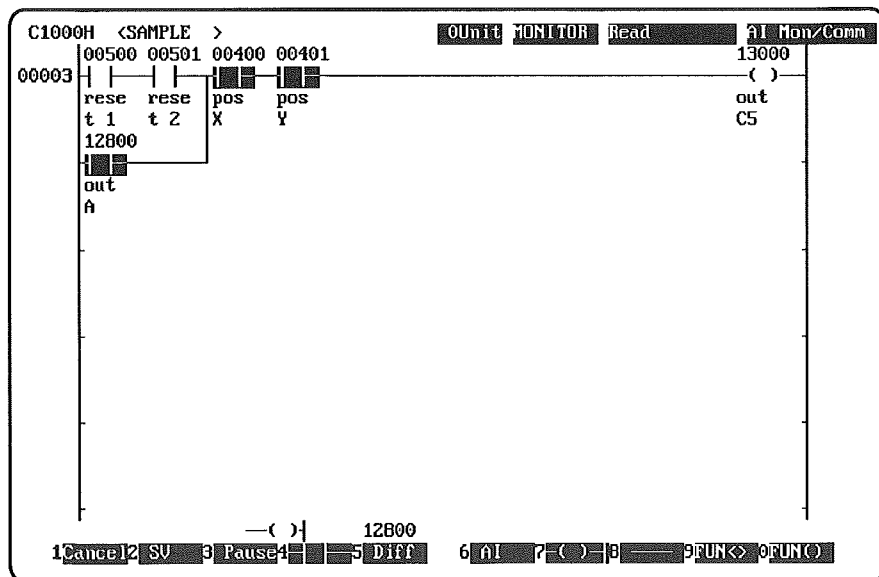

- Press Enter again if the execution condition at the cursor is the cause of the problem. The next instruction block will be searched and the cursor will be moved to the execution condition that seems to be preventing the output from going ON. In this case the cursor is moved to IR 00103.

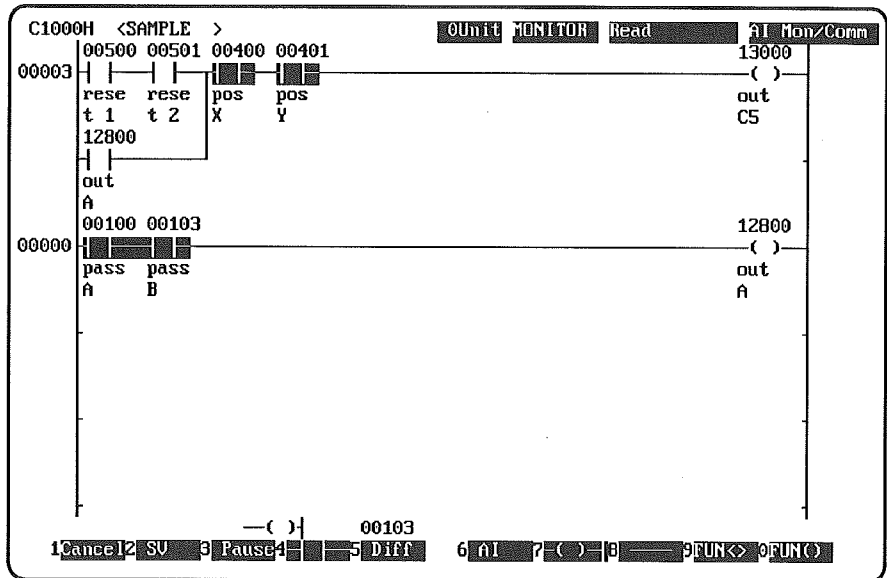

- Continue searching if necessary. A message will be displayed when there aren't any more execution conditions that could prevent activation of the specified output.

## 10-6 Changing the Display Mode

The ladder diagram can be displayed with or without comments (I/O, instruction, and block comments). The Ladder with Comments format should be used when writing or editing comments. The normal ladder format can be used when it isn't necessary to display the comments.

### Ladder Diagram Format

This command will display the online PC's operating status and its program in ladder diagram format. Comments will not be displayed in this mode.

To view a program in the Ladder Diagram format, use the End Key to display the Online Menu and select "H:Change display" and then "L:Ladder diagram."

### Ladder with Comments Format

This command will display the online PC's operating status and its program in the ladder diagram with comments format. Comments will be displayed.

To view a program in the Ladder with Comments format, use the End Key to display the Online Menu and select "H:Change display" and then "C:Ladder with comments."

### 10-6-1 Changing Set Values

The F2 Key can be used to change the set values of PC timers and counters while the PC is in MONITOR or PROGRAM mode.



**Caution** Never change the set value of a timer or counter without first confirming that no problems will result in the controlled system. Depending on the controlled system, changes to the set value of a timer or counter can have serious and unexpected results.

This operation is not possible when the PC is in RUN mode.

The set values of following timer and counter instructions can be accessed and changed with this operation: CNT, TIM, CNTR, TIMH, TIMW, CNTW, and TMHW. The set values can be incremented, decremented, or changed to a constant value or word address. Incrementing and decrementing are possible only when the SV is set as a constant.

Timer and counter present values can also be changed while monitoring data online. See 10-10-10 *Changing Present Values* for details.

**Function Keys** The allocations of the function keys will change when F2 is press to begin the operation to change SV. The function key allocations for the operation are as follows:

| Key         | Function   |
|-------------|--|
| F1:FUN()    | Used to specify counter and timer instructions that have function codes.   |
| F2:FUN<>    | Used to specify block programming timer and counters.                      |
| F9:Fine     | Used to increment and decrement a constant set as an SV (fine adjustment). |
| F10:Chang   | Used to change the SV to another constant or word address.                 |
| Ctrl+F6:CNT | Used to specify counters.  |
| Ctrl+F6:TIM | Used to specify timers.  |

**Procedure** The following procedure shows how to change the set value of a timer or counter.

- 1, 2, 3...
1. Display the timer or counter instruction whose set value you want to change and press F2. (It isn't necessary to have the timer/counter instruction on-screen, but this allows the user to verify that the new SV is correct.)

**Note** Press Enter and Escape to return to monitor mode. If Escape is pressed anytime prior to pressing Enter, no changes will be made.

2. Enter the key sequence for the timer/counter instruction. The instruction and the set value will be displayed in the lower center of the screen. The following table shows the possible key sequences.

| Instruction | Key sequence                          |
|-------------|---------------------------------------|
| CNT         | Ctrl, F5, Counter number, Enter       |
| TIM         | Ctrl, F6, Timer number, Enter         |
| CNTR        | F1 (FUN()), 12, Counter number, Enter |
| TIMH        | F1 (FUN()), 15, Timer number, Enter   |
| TIMW        | F2 (FUN<>), 13, Timer number, Enter   |
| CNTW        | F2 (FUN<>), 14, Counter number, Enter |
| TMHW        | F2 (FUN<>), 15, Timer number, Enter   |

3. The set value can be changed in three ways:
  - a) To increment or decrement an SV set as a constant, press F9 (Fine). Press the Up Cursor Key to increment the SV and press the Down Cursor Key to decrement the SV, and press Enter to register the change.
  - b) To change the SV to a constant, press F10, input a new SV, and press Enter.
  - c) To change the SV to a word address, specify the data area, input the word address, and press Enter. The following table shows the key sequences for word addresses. Press Ctrl+F10 to return to a constant SV.

| Data area | Key sequence                          |
|-----------|---------------------------------------|
| IR        | Ctrl+F7, word address, Enter          |
| AR        | Ctrl+F7, Ctrl+F1, word address, Enter |
| HR        | Ctrl+F7, Ctrl+F2, word address, Enter |
| LR        | Ctrl+F7, Ctrl+F3, word address, Enter |
| DM        | Ctrl+F4, word address, Enter          |
| *DM       | Ctrl+F8, word address, Enter          |

4. Press Escape to return to Monitor mode.

**Incrementing a Timer SV** The following example shows how to increment the set value of timer TIM 010.

1, 2, 3...

1. Display the program address that contains timer TIM 010.

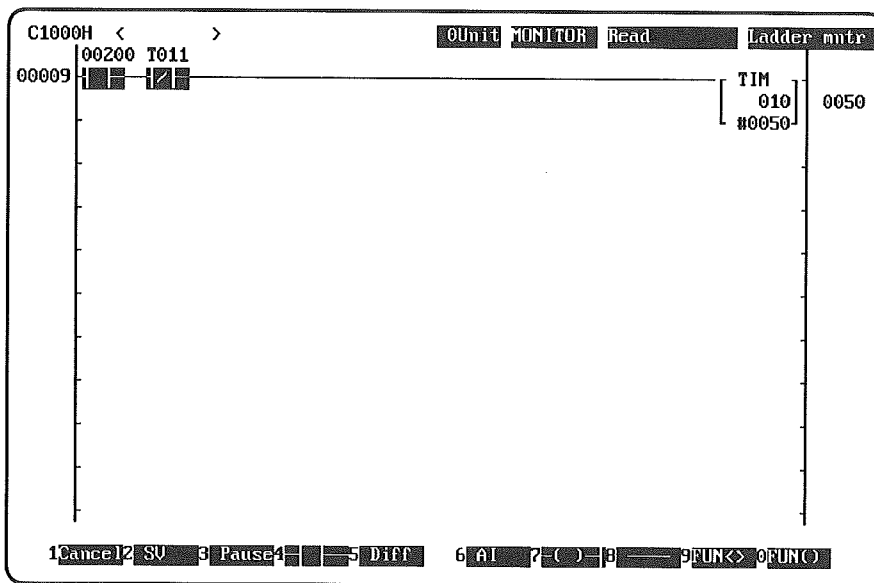

2. Press F2. (The function key display at the bottom of the screen will change.)

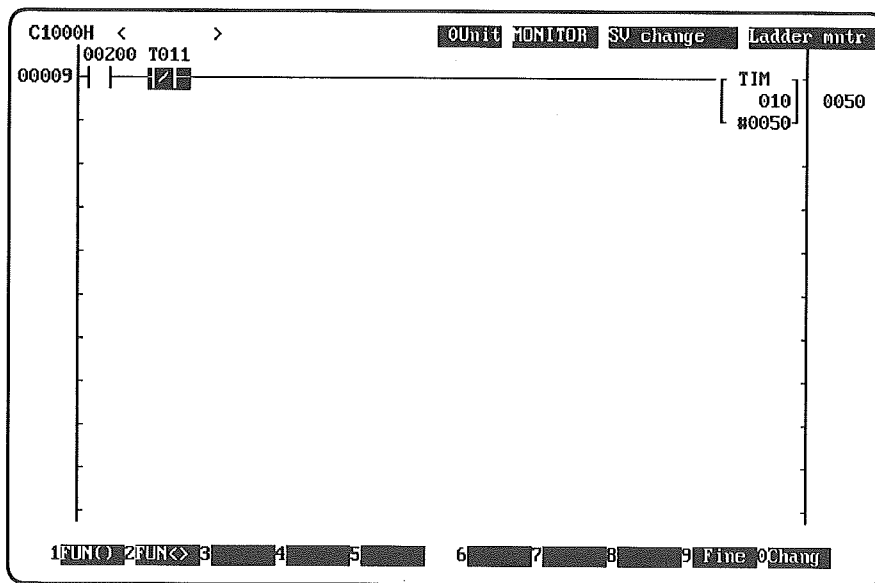

3. Enter the key sequence for TIM 010 by pressing Ctrl+F6, 10, and Enter. The set value will be displayed at the bottom of the screen. In this case the SV is #0050.

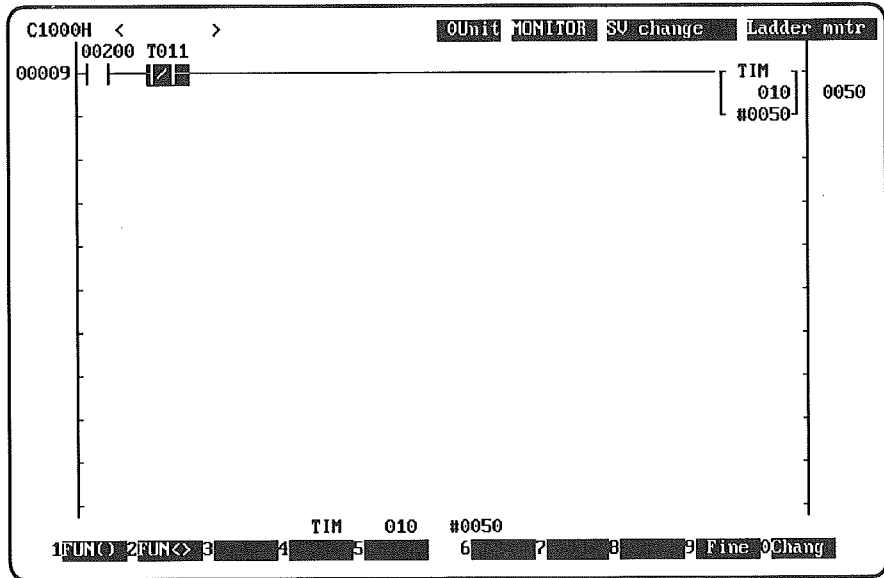

4. Press F9 (Fine) to enable incrementing/decrementing.

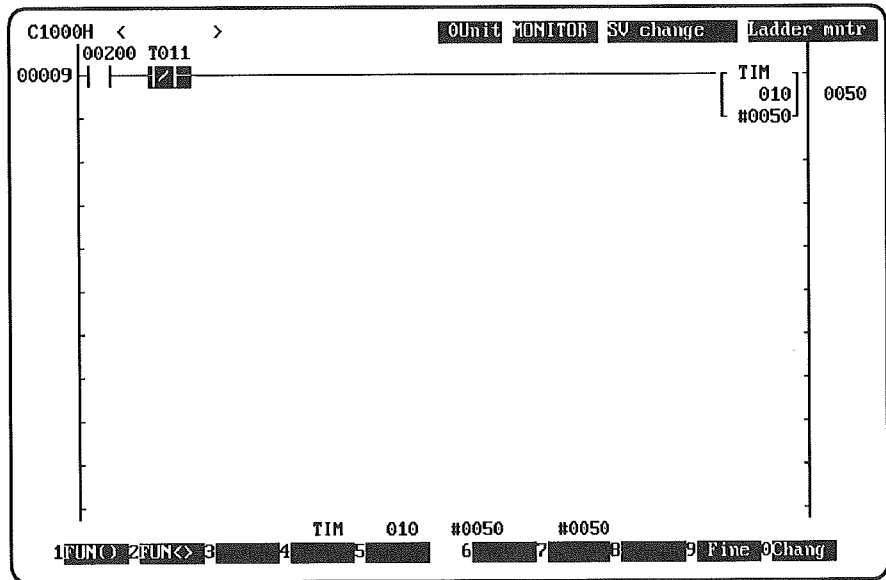

- Press the Down Cursor Key 6 times to increment the SV by 6.

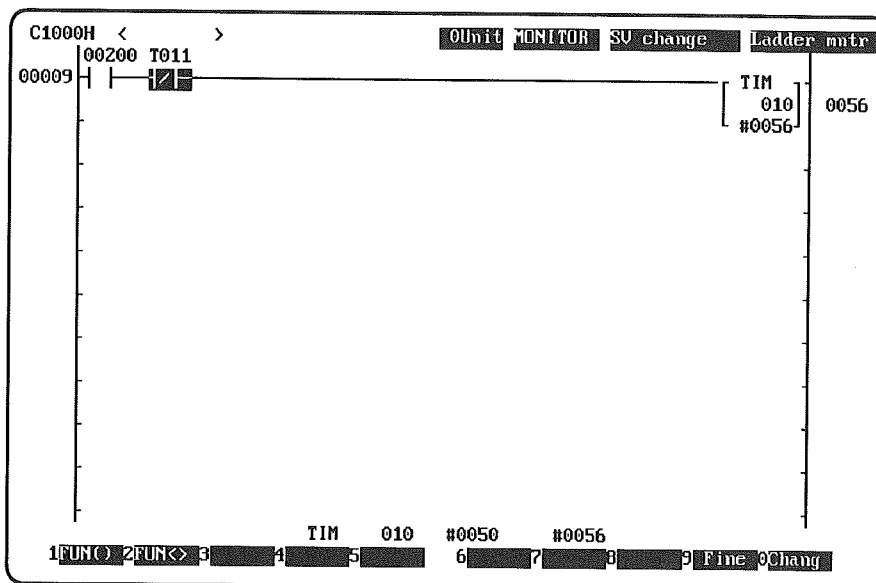

**Changing a Timer SV**

The following example shows how to change the set value of timer TIM 010 from a constant (#0050) to a word address (IR 200).

1, 2, 3...

- Monitor the program address that contains timer TIM 010.
- Press F2. (The function key display at the bottom of the screen will change.)
- Enter the key sequence for TIM 010 by pressing Ctrl+F6, 10, and Enter. The set value will be displayed at the bottom of the screen.
- Press F10 (Chang) to display an input area for the new SV.

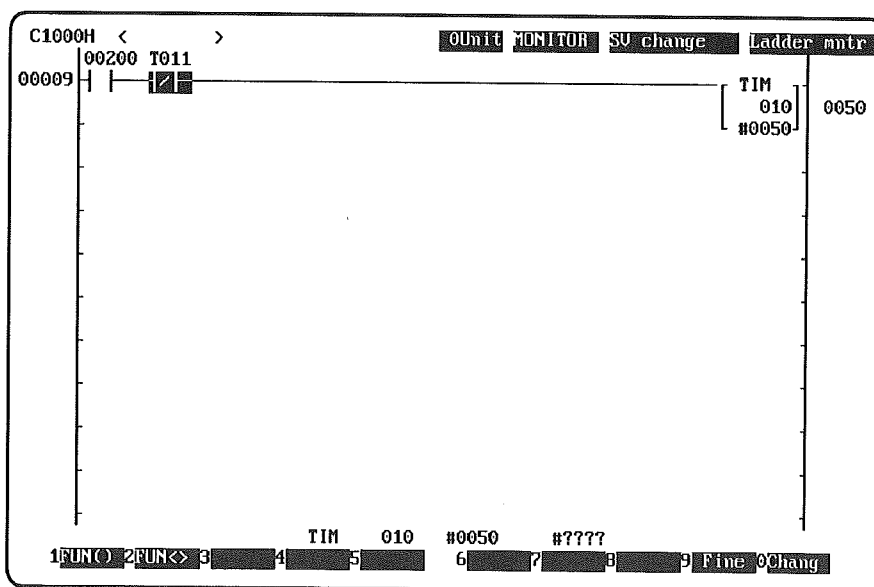



5. Enter the word address for IR 200 by pressing Ctrl+F7, 200, and Enter.

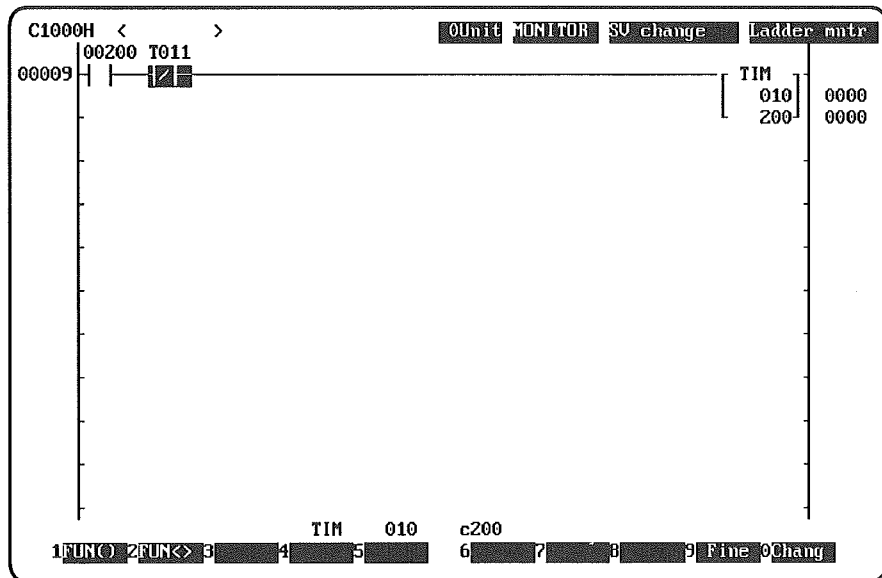

## 10-7 Pause

The F3 Key can be used to freeze the monitoring display unconditionally or when a specified bit changes status. Although the monitoring display will be stopped, PC operation will continue.

This operation is useful in determining the program's status when the specified bit is turned ON (up-differentiation) or OFF (down-differentiation). The status of bits in the IR, HR, AR, LR, TIM, or CNT areas can be specified.

Other operations (such as displaying the menu or the ladder diagram) are disabled when the monitoring display is frozen. Press the Escape Key to return to the monitoring display before performing other operations.

- Note**
1. Do not set pause conditions which are established only for a short time, such as those that will be ON for one cycle only. The pause condition may not be recognized if the length of the PC's communication cycle exceeds about 0.3 seconds.
  2. Do not specify bits that do not change. For example, monitoring will never be paused if the Always ON or Always OFF Flags are specified, because these flags never change status.

**Procedure** The following procedure shows how to pause the monitoring display.

- 1, 2, 3...** 1. Press F3 while from the monitor display. The function key display at the bottom of the screen will change and the display for F10 (Begin) will flash.

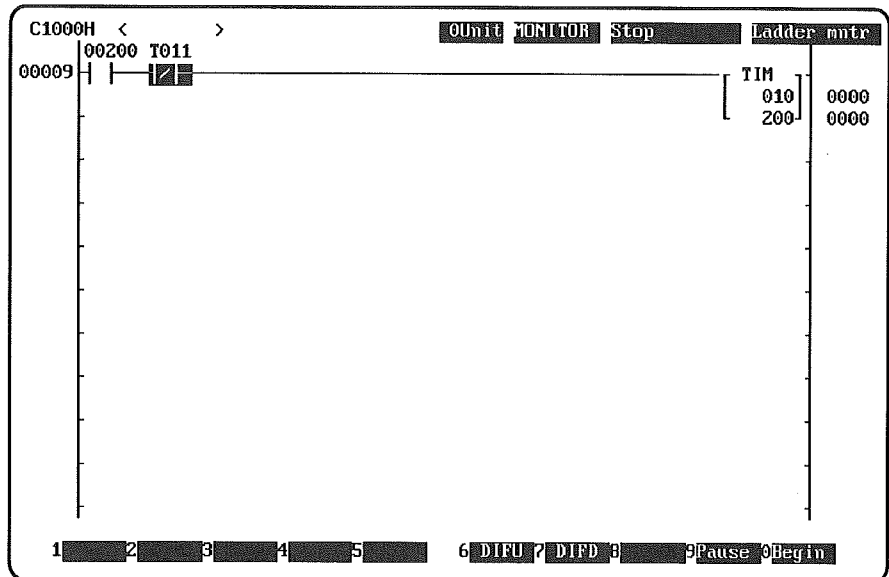

2. Monitoring can be paused immediately at this point by pressing F9 (Pause) or a bit address can be input as a condition for pausing. To specify a condition:
- Press Ctrl, and input the desired data area followed by the bit address.
  - Press F6 to pause monitoring when the specified bit goes from OFF to ON, or press F7 to pause monitoring when the specified bit goes from ON to OFF. The ON/OFF status of the specified bit will be displayed at the bottom of the screen.
  - Press F10 (Begin) to resume monitoring with the same condition.
3. Press Escape to return to the normal monitoring display.

**Example** The following example uses HR 0001 as an up-differentiated (OFF→ ON) condition to pause the monitoring display.

- 1, 2, 3... 1. Display an instruction block that contains HR 0001.

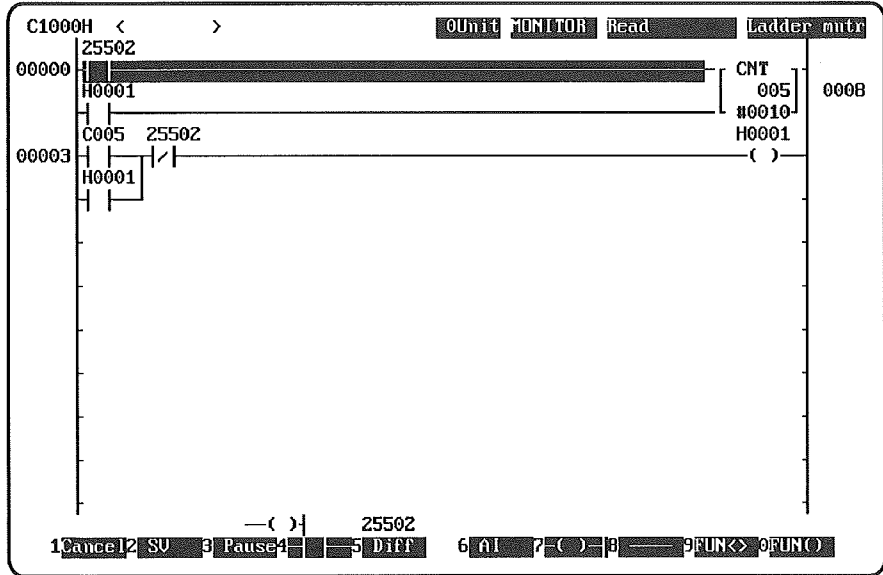

2. Press F3. The function key display at the bottom of the screen will change and the display for F10 (Begin) will flash.

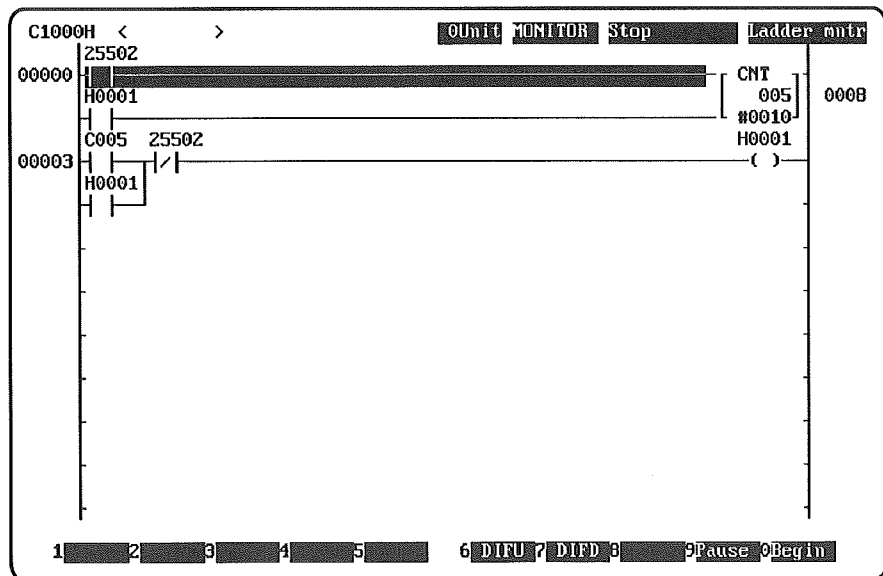

- Specify HR 0001 by pressing Ctrl+F9, Ctrl+F2, and 1. Press F6 to indicate up-differentiation and then press Enter. The ON/OFF status of HR 0001 will be displayed.

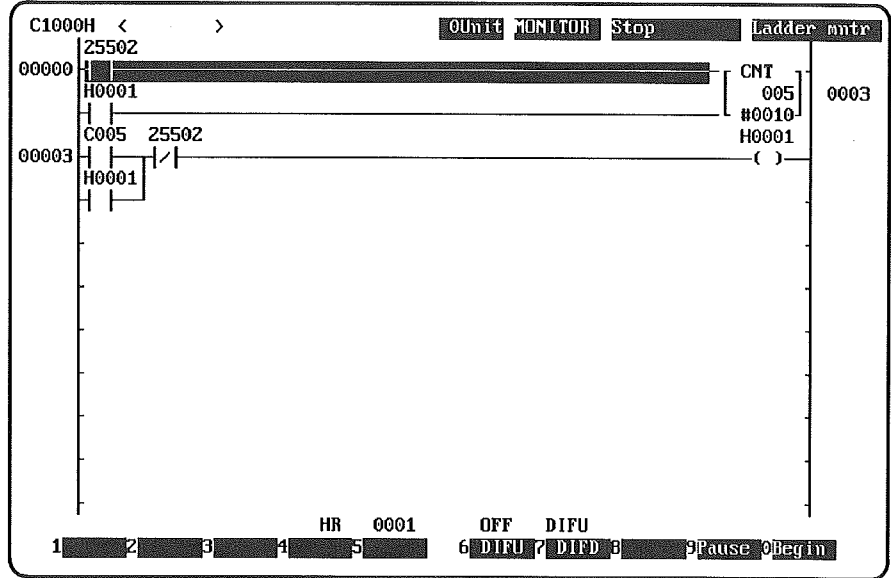

- When HR 0001 goes from OFF to ON, the monitoring display will pause and Pause will flash at F9.

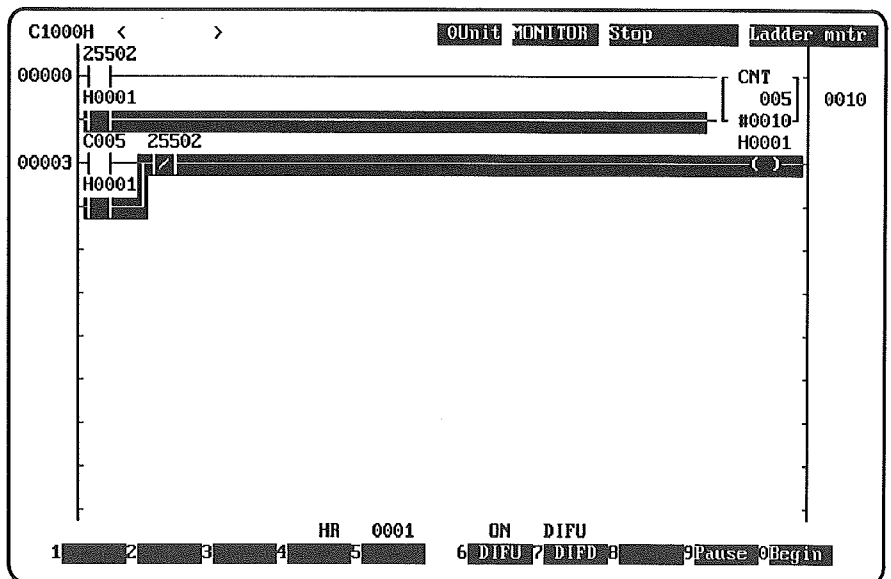

## 10-8 Differential Monitor

This operation detects the OFF→ ON (up-differentiation) or ON→ OFF (down-differentiation) changes in the specified bit's status and displays it in reverse video. This operation is possible with the CQM1 and C200HS, C200HX/C200HG/C200HE PCs only.

Although the buzzer will sound when the differentiation condition is detected, PC operation will continue.

Other operations, such as displaying the menu and ladder diagrams, are not possible in the differentiate monitor mode.

**Procedure** The following procedure shows how to perform differentiation monitoring.

- 1, 2, 3... 1. Display the bit to be monitored.
2. Press the F5 Key. The Function Key assignments will change: F9 will be assigned to DIFU; F10, to DIFD.
3. Move the cursor to the bit to be monitored and press Enter.
4. Press F9 to detect an OFF-to-ON transition in the specified bit or press F10 to detect an ON-to-OFF transition, and then press Enter.

When the transition occurs, the specified bit will be displayed in reverse video and the monitoring operation will continue.

5. Press the Escape Key once to return to the start of the Differential Monitor operation and twice to return to the normal monitoring display.

**Example** The following example indicates up-differentiation (OFF→ ON changes) of IR 10012.

- 1, 2, 3... 1. Display an instruction block that contains IR 10012.

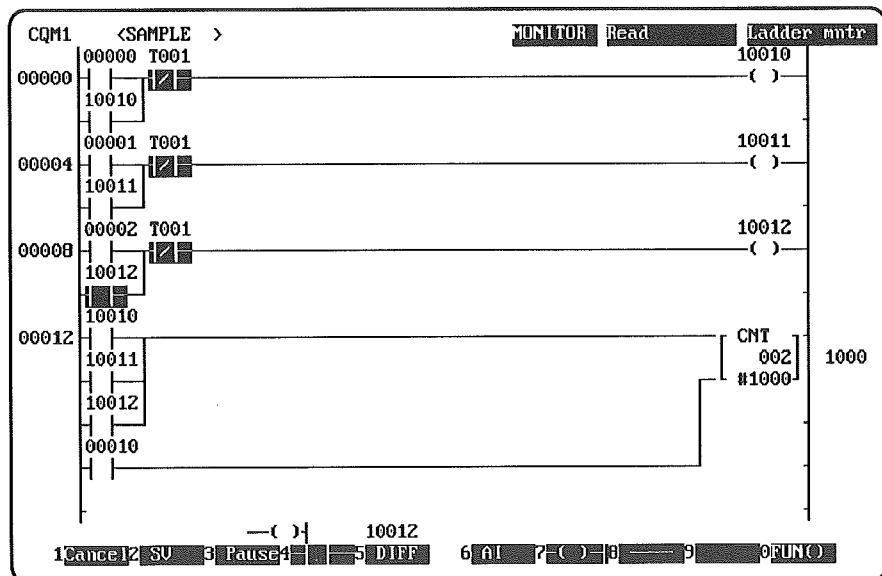

2. Press F5, move the cursor to IR 10012, and press Enter.

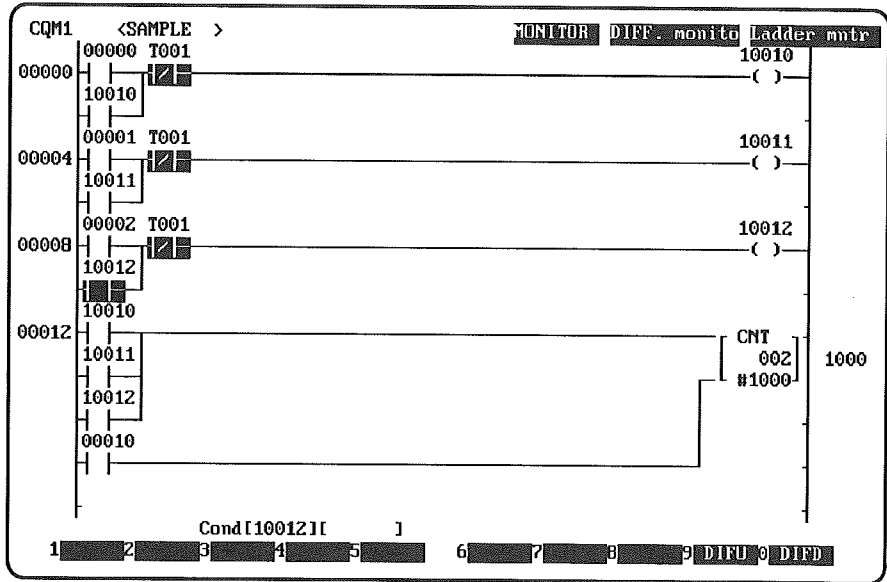

3. Press F9 to indicate up-differentiation and then press Enter. The bit will be displayed in reverse video and the buzzer will sound when the bit turns ON.

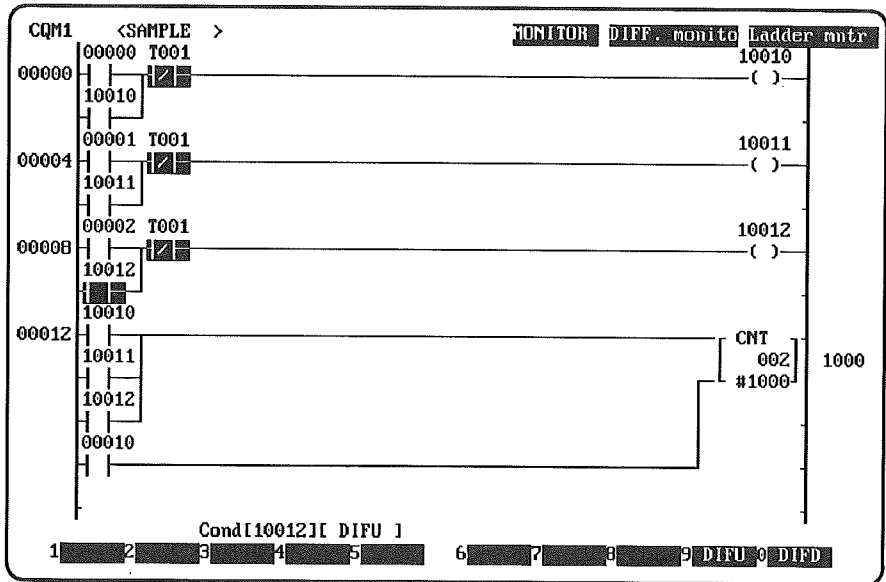

### 10-9 Clearing Errors

The F1 Key can be pressed to clear errors from PC memory. Error messages are displayed at the top-left of the screen and should be cleared after taking appropriate measures to remove the cause of the error. The error message cannot be cleared if its cause isn't removed.

**Procedure** The following procedure shows how to clear errors.

- 1, 2, 3... 1. Error messages are displayed at the top-left of the screen.

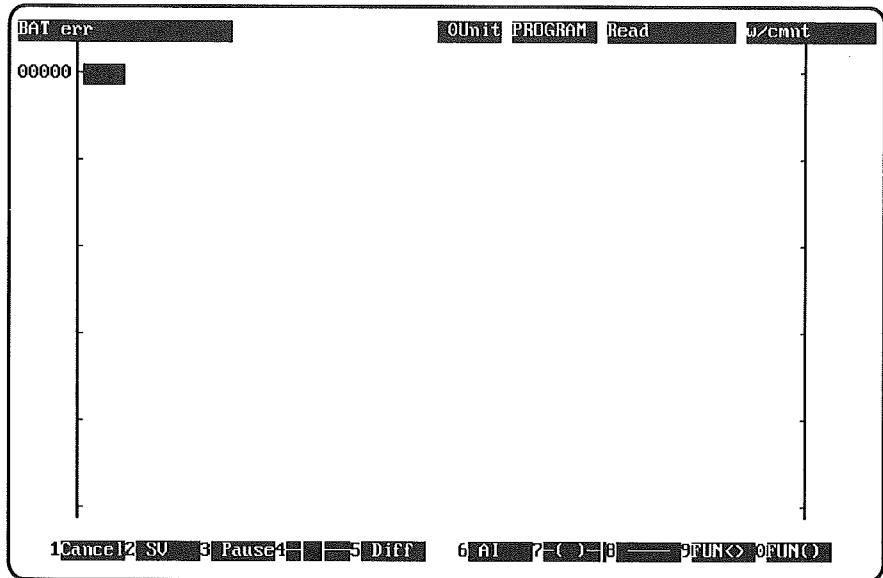

2. Eliminate the cause of the battery error and press F1. Another error message will be displayed if there is another error.
3. Continue displaying error messages, eliminate their causes, and clearing the errors by pressing F1 until all the errors are cleared.

### 10-10 Monitor Data Operations

The Monitor Data operation uses the lower third of the display screen as a multi-item monitor area for displaying the status of up to 20 bits or words. This operation can be used to monitor and change the status or contents of timers, counters, bits, and words in memory.

Word data can be displayed in hexadecimal, signed or unsigned decimal, long, binary, or ASCII formats.

### 10-10-1 Monitor Data Display

The following display will appear when "N:Monitor data" is selected from the basic monitor display. The *Data monitor* area at the bottom of the screen is used to monitor specified bits

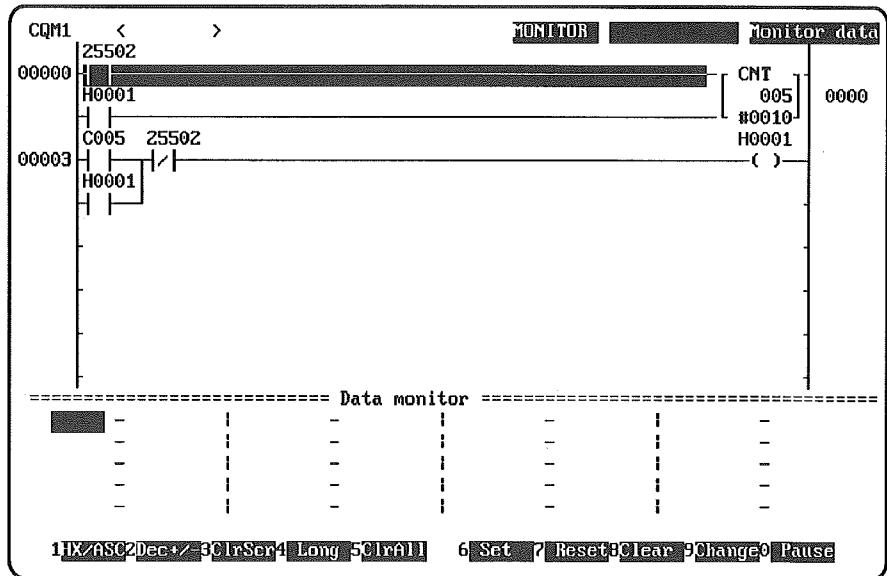

### 10-10-2 Function Key Operations

- F1: HX/ASC** Press the F1 Key to toggle between hexadecimal and ASCII formats. If F1 is pressed while signed/unsigned decimal is displayed, the display will switch to hexadecimal/ASCII format.  
See 10-10-5 Changing to ASCII Format for details.
- F2: Dec+/-** Press the F2 Key to toggle between signed and unsigned decimal formats. If F2 is pressed while hexadecimal/ASCII is displayed, the display will switch to signed/unsigned decimal format.
- F3: ClrFor** Used to release the forced-set or forced-reset status of the bit at the cursor (C200H, C200HS, C200HX/C200HG/C200HE, and CQM1 only).  
See 10-10-9 Releasing Force-set/Force-reset Bits for details.
- F4: Long** Press the F4 Key to toggle between standard (1-word) and long (2-word) decimal formats. The words used for long data are the word at the cursor location and the subsequent word. Long data will be displayed at the bottom of the screen.  
The long format is applicable to signed/unsigned decimal only.
- F5: ClrAll** Used to release the forced-set or forced-reset status of all bits (C200H, C200HS, C200HX/C200HG/C200HE, and CQM1 only).  
See 10-10-9 Releasing Force-set/Force-reset Bits for details.
- F6: Set** Used to force-set the bit at the cursor. Only one bit can be force-set at one time using the F6 Key. This operation is not possible in RUN mode.  
See 10-10-7 Force-setting/Force-resetting Single Bit for details.
- Shift+F6: Set** Used to force-set the bit at the cursor. Multiple bits can be force-set using Shift+F6 (C200H, C200HS, C200HX/C200HG/C200HE, and CQM1 only).  
See 10-10-8 Force-setting/Force-resetting Multiple Bits for details.
- F7: Reset** Used to force-reset the bit at the cursor. Only one bit can be force-reset at one time using the F7 Key. This operation is not possible in RUN mode.  
See 10-10-7 Force-setting/Force-resetting Single Bit for details.



**Shift+F7: Reset** Used to force-reset the bit at the cursor. Multiple bits can be force-reset using Shift+F7 (C200H, C200HS, C200HX/C200HG/C200HE, and CQM1 only).  
See 10-10-8 Force-setting/Force-resetting Multiple Bits for details.

**F8: Clear** The F8 Key clears all items displayed in the data monitor area.  
See 10-10-6 Clearing the Monitor Data Display for details.

**F9: Change** Press the F9 Key to change the present value of the timer, counter, or content of the word where the cursor is located. This operation is not possible in RUN mode.  
See 10-10-10 Changing Present Values for details.

**F10: Pause** The F10 key allows PC monitoring to be frozen at any point, while allowing the PC to continue operating.  
See 10-10-11 Pause for details.

**Note** Bits cannot be force-set or force-reset when the PC is in RUN mode. Forced status cannot be cleared when the PC is in RUN mode.

### 10-10-3 Specifying Words and Bits

To designate items to be monitored, move the cursor to a cell in the data monitor area and press the Ctrl Key to access the following Function Keys.

**Specifying Bits** To designate a bit, press Ctrl+F9, followed by the data area prefix and address. Data area prefixes are not required for the IR and SR area.

| Data area | Key sequence                      |
|-----------|-----------------------------------|
| IR, SR    | Ctrl+F9 Bit_address Enter         |
| HR        | Ctrl+F9 Ctrl+F2 Bit_address Enter |
| AR        | Ctrl+F9 Ctrl+F1 Bit_address Enter |
| LR        | Ctrl+F9 Ctrl+F3 Bit_address Enter |

**Specifying Words** To designate a word, press Ctrl+F7, followed by the data area prefix and address. Data area prefixes are not required for the IR and SR area.

| Data area | Key sequence                       |
|-----------|------------------------------------|
| IR, SR    | Ctrl+F7 Word_address Enter         |
| HR        | Ctrl+F7 Ctrl+F2 Word_address Enter |
| AR        | Ctrl+F7 Ctrl+F1 Word_address Enter |
| LR        | Ctrl+F7 Ctrl+F3 Word_address Enter |

**Specifying DM, EM, TIM, CNT** To designate DM words, EM words, counters, or timers, press Ctrl+F4, Shift+Ctrl+F4, F5, and F6, respectively, followed by the address or counter/timer number.

| Data area         | Key sequence  |
|-------------------|---|
| DM                | Ctrl+F4 DM_address Enter  |
| EM<br>(See note.) | Shift+Ctrl+F4 Shift+Ctrl+F3 EM Bank_number EM_number Enter<br>(Use this key sequence when specifying a particular EM bank.) |
|                   | Shift+Ctrl+F4 Shift+Ctrl+F3 Shift+Ctrl+F2 EM_number Enter<br>(Use this key sequence when specifying the current EM bank.)   |
| TIM               | Ctrl+F6 TIM_number Enter  |
| CNT               | Ctrl+F5 CNT_number Enter  |

**Note** The EM bank number designation can be omitted if it isn't necessary to specify the EM bank number.

### 10-10-4 Monitoring Example

The following example shows how to monitor the status of HR 0002, IR 200, DM 0001, TIM 005, and EM1\_0400.

- 1, 2, 3...
1. Select "N:Monitor data" from the Online Menu.
  2. Input HR 0002 by pressing Ctrl+F9, Ctrl+F2, 2, and Enter. The subsequent bit address (HR 0003) will be displayed in the input area.

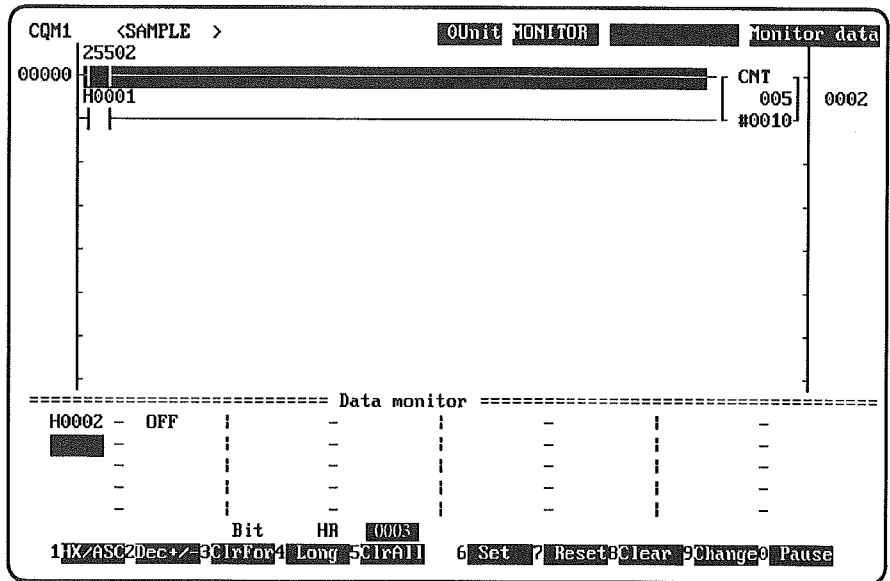

3. Input IR 200 by pressing Ctrl+F7, 200, and Enter.

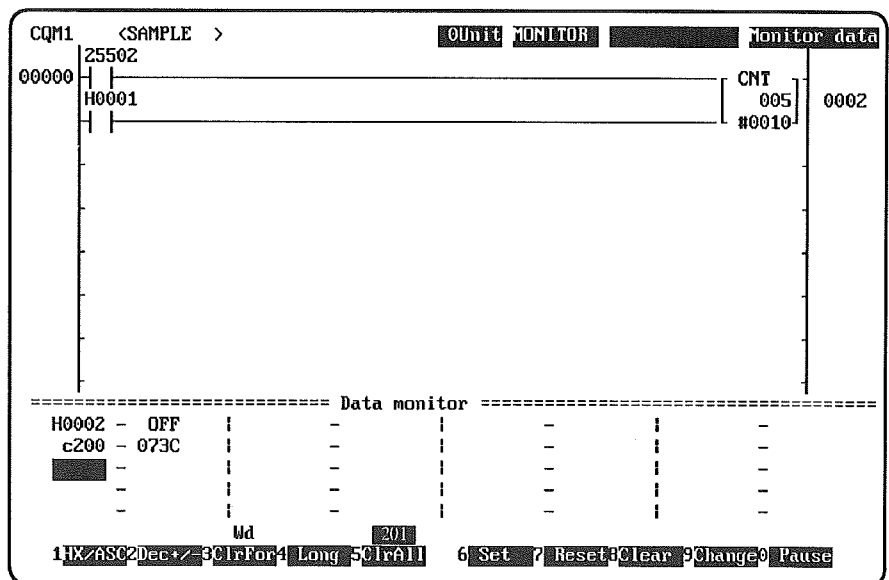

4. Input DM 0001 by pressing Ctrl+F4, 1, and Enter.

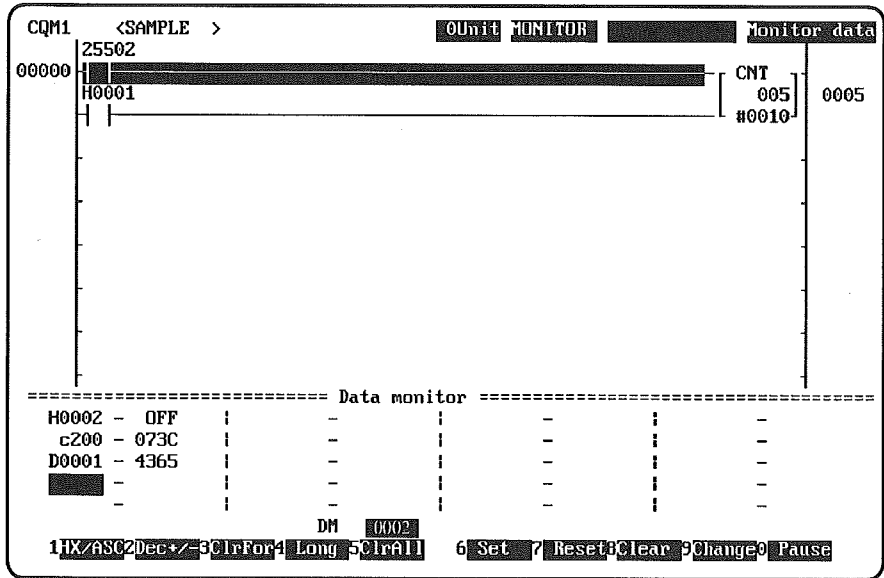

5. Input TIM 005 by pressing Ctrl+F6, 5, and Enter.

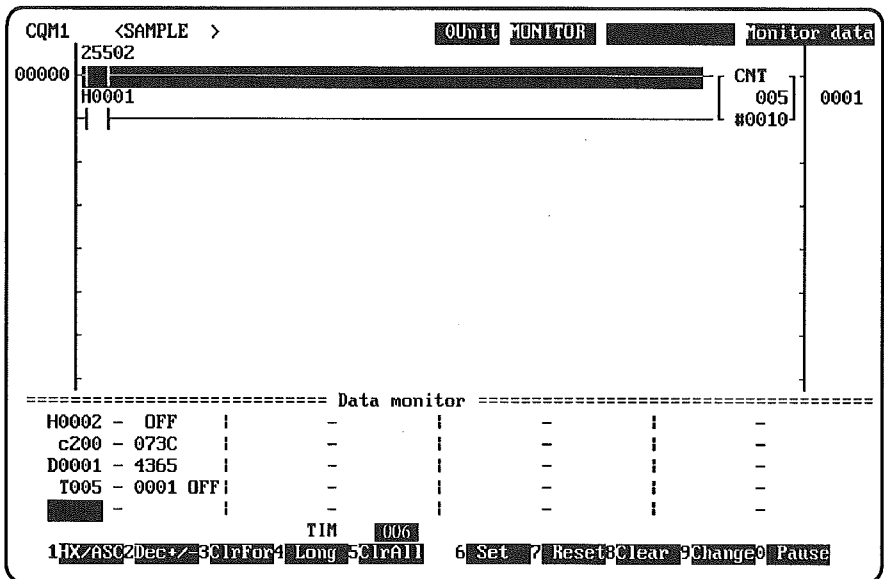

- Input EM 1\_0400 by pressing Shift+Ctrl+F4, Shift+Ctrl+F3, 1400, and Enter.

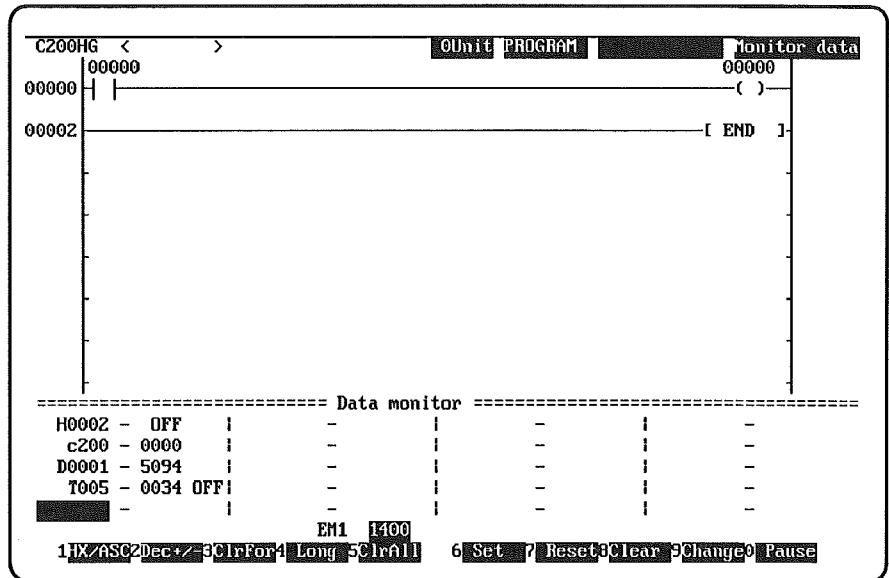

### 10-10-5 Changing to ASCII Format

The following example shows how to change the data display to ASCII format.

- 1, 2, 3... 1. Data displayed in hexadecimal can be changed to ASCII by pressing F1. An "A" will be displayed in the lower-left corner of the screen to indicate ASCII format.

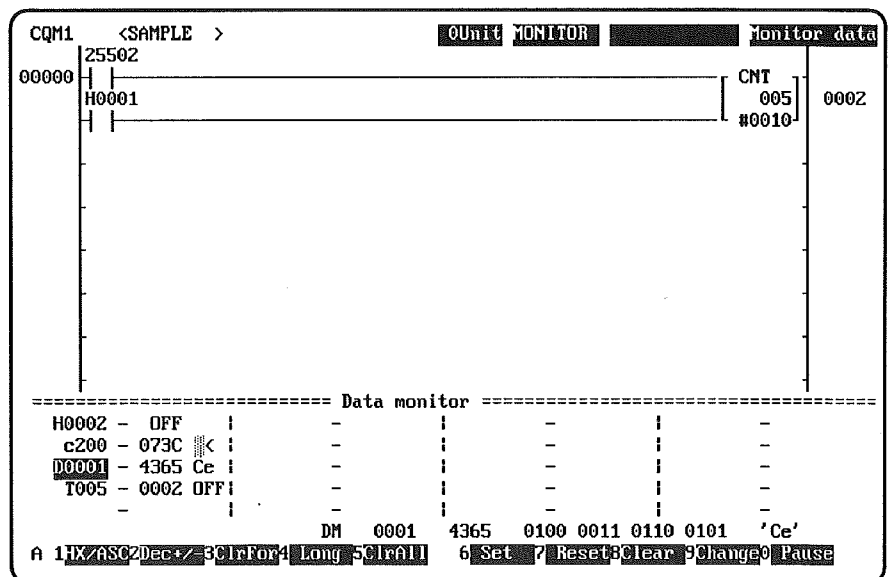

- Press F1 again to return to hexadecimal format.

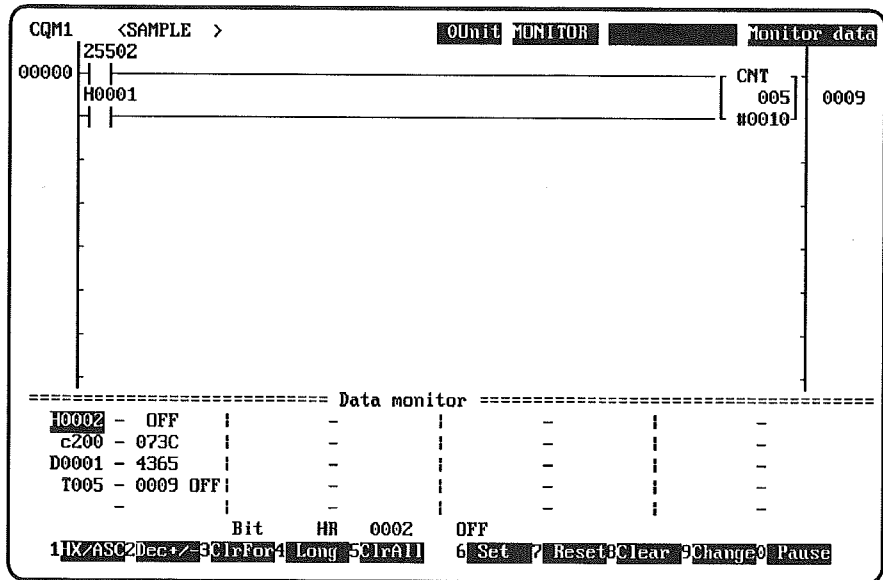

### 10-10-6 Clearing the Monitor Data Display

The following example shows how to clear the data display.

- The Monitor Data display can be cleared by pressing F8. A confirmation prompt will be displayed.

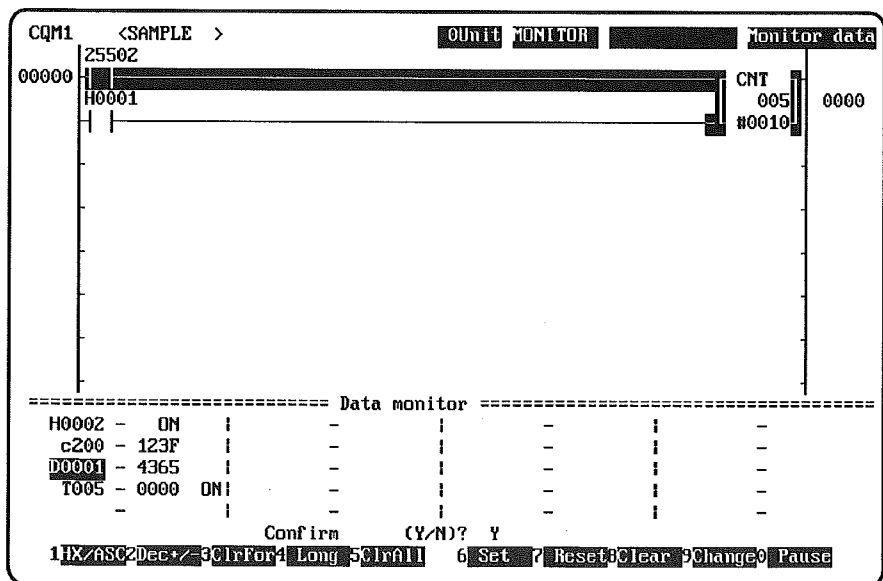

- press Enter to clear the display.

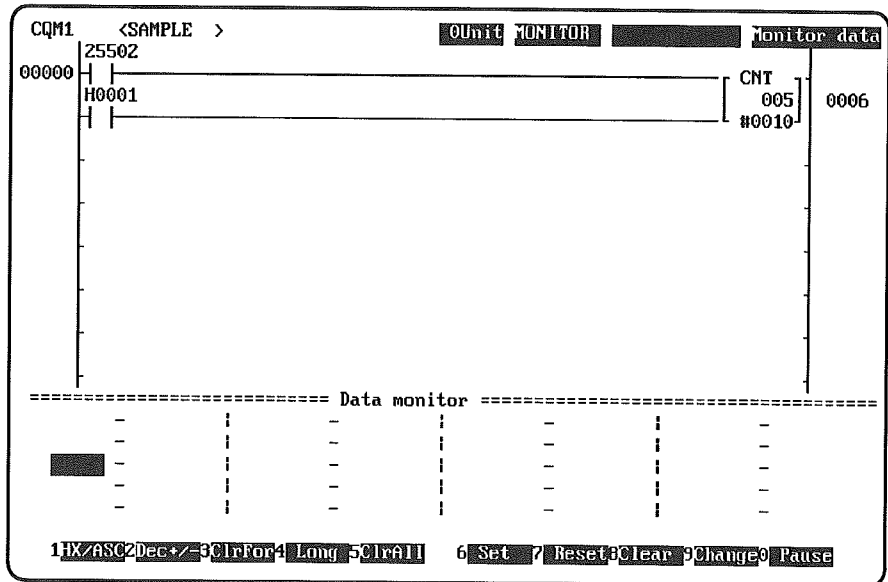

### 10-10-7 Force-setting/Force-resetting Single Bits

The following example shows how to force-set (turn on) and force-reset (turn off) a single bit.

These operations are not possible in RUN mode.

**! Caution** Never force-set or force-reset bits in memory without first confirming that no problems will result in the controlled system. Depending on the controlled system, force-setting or force-resetting bits in memory can have serious and unexpected results.

If an output bit is force-set/force-reset in MONITOR mode, its corresponding output point will be turned ON/OFF.

Press F6 to force-set a bit; this bit status is indicated by an "S." Press F7 to force-reset a bit; this status is indicated by an "R."

Only one bit may be force-set/force-reset at a time using this operation, so a bit that has been force-set/force-reset must be released before force-setting/force-resetting another bit. More than one bit can be force-set/force-reset in C200H, C200HS, and CQM1 PCs. Refer to 10-10-8 Force-setting/Force-resetting Multiple Bits for details.

When a bit is force-set or force-reset, the following keys cannot be used: F2, F4, F8, F9 and F10. The force-set/force-reset status must be released before using these keys.

Refer to 10-10-9 Releasing Force-set/Force-reset Bits for details on releasing forced status.

- 1, 2, 3... 1. Move the cursor to HR 0002.

```

CQM1 <SAMPLE >          OUnit MONITOR          Monitor data
00000 25502
      |-----|
      | H0001 | [ CNT 005 ] 0003
      |-----|
      |-----| [ #0010 ]
  
```

---

```

===== Data monitor =====
H0002 - OFF | - | - | - | -
c200 - 073C | - | - | - | -
D0001 - 4365 | - | - | - | -
T005 - 0003 OFF | - | - | - | -
  
```

Bit HR 0002 OFF

1HX/ASC2Dec+/-3ClrFor4Long5ClrAll 6Set7Reset8Clear9Change0Pause

2. Press F6 to force-set HR 0002. An "S" will be displayed next to the bit address.

```

CQM1 <SAMPLE >          OUnit MONITOR          Monitor data
00000 25502
      |-----|
      | H0001 | [ CNT 005 ] 0004
      |-----|
      |-----| [ #0010 ]
  
```

---

```

===== Data monitor =====
H0002 -S ON | - | - | - | -
c200 - 073C | - | - | - | -
D0001 - 4365 | - | - | - | -
T005 - 0004 OFF | - | - | - | -
  
```

Bit HR 0002 S ON Set

1HX/ASC2Dec+/-3ClrFor4Long5ClrAll 6Set7Reset8Clear9Change0Pause

3. Press F7 to force-reset HR 0002. An "R" will be displayed next to the bit address.

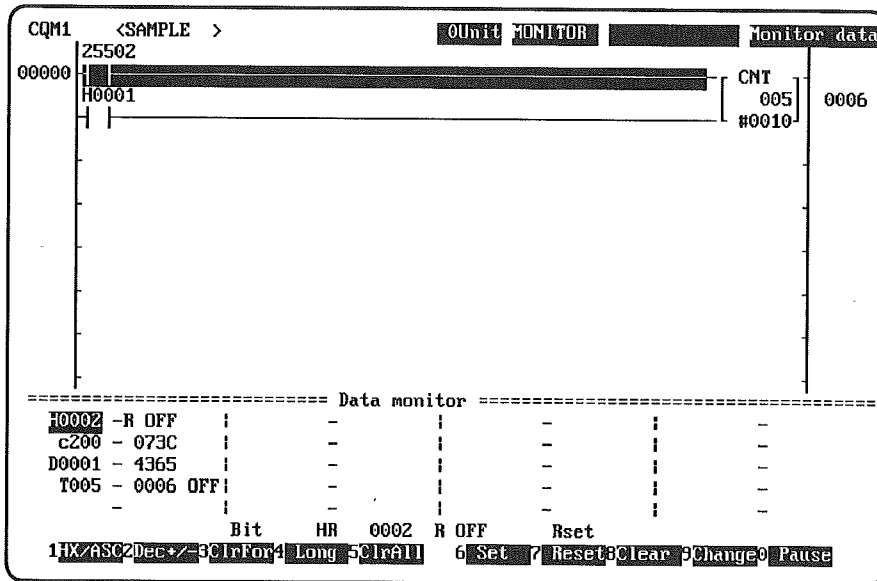

### 10-10-8 Force-setting/Force-resetting Multiple Bits

More than one bit can be force-set/force-reset at a time in C200H, C200HS, C200HX/ C200HG/C200HE and CQM1 PCs. The following example shows how to force-set (turn on) and force-reset (turn off) several bits. These operations are possible in any PC mode except RUN mode. If an output bit is force-set/force-reset in MONITOR mode, its corresponding output point will be turned ON/OFF.

**Caution** Never force-set or force-reset bits in memory without first confirming that no problems will result in the controlled system. Depending on the controlled system, force-setting or force-resetting bits in memory can have serious and unexpected results.

Press Shift+F6 to force-set a bit; this bit status is indicated by an "S." Press Shift+F7 to force-reset a bit; this status is indicated by an "R."

Refer to 10-10-9 Releasing Force-set/Force-reset Bits for details on releasing forced status.



- 1, 2, 3... 1. Move the cursor to HR 0002.

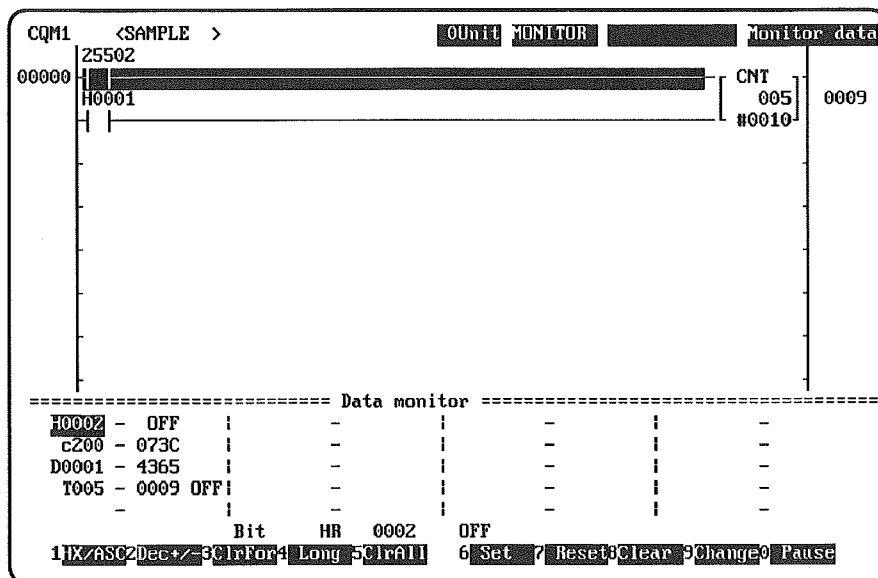

2. Press Shift+F6 to force-set HR 0002. An "S" will be displayed next to the bit address.

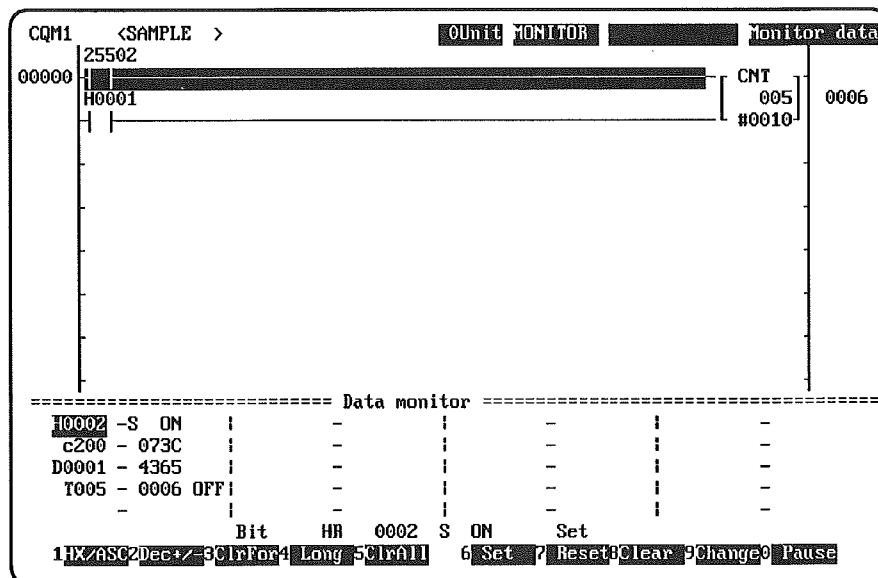

3. Move the cursor to T005 and press Shift+F6 to force-set TIM 005.

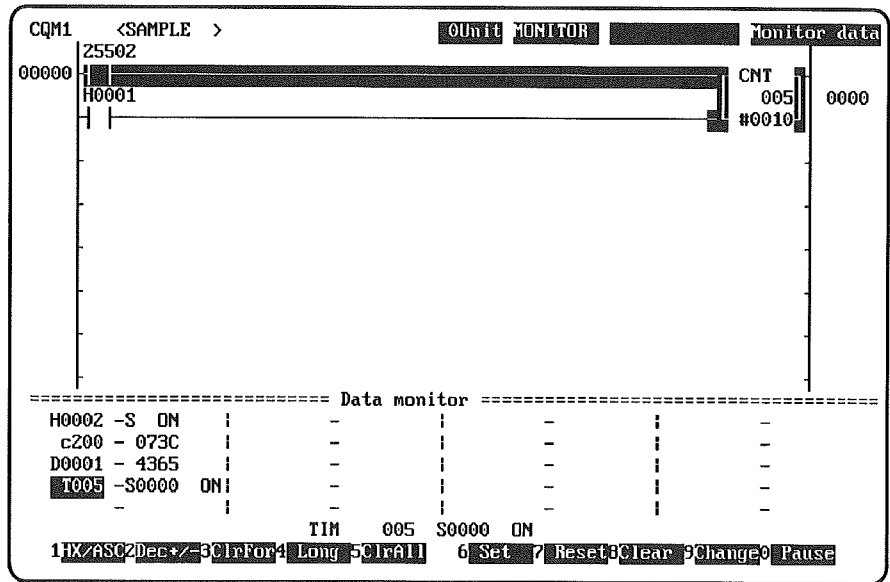

### 10-10-9 Releasing Force-set/Force-reset Bits

The following examples show how to release the force-set or force-reset bit status. The bit or bits will return to their original status when released.

**Caution** Never force-set or force-reset bits in memory without first confirming that no problems will result in the controlled system. Depending on the controlled system, force-setting or force-resetting bits in memory can have serious and unexpected results.

With PCs other than the C200H, C200HS, and CQM1, press Escape to release the forced status of the bit at the cursor. The "S" or "R" that indicated forced status will be released.

With the C200H, C200HS, and CQM1, press F3 to release the forced status of the bit at the cursor. Press F5 to release the forced status of all bits that have been force-set or force-reset.

**Release Individual Bits**  
1, 2, 3...

The following example shows how to release the forced status of just one bit.

1. Move the cursor to HR 0002.

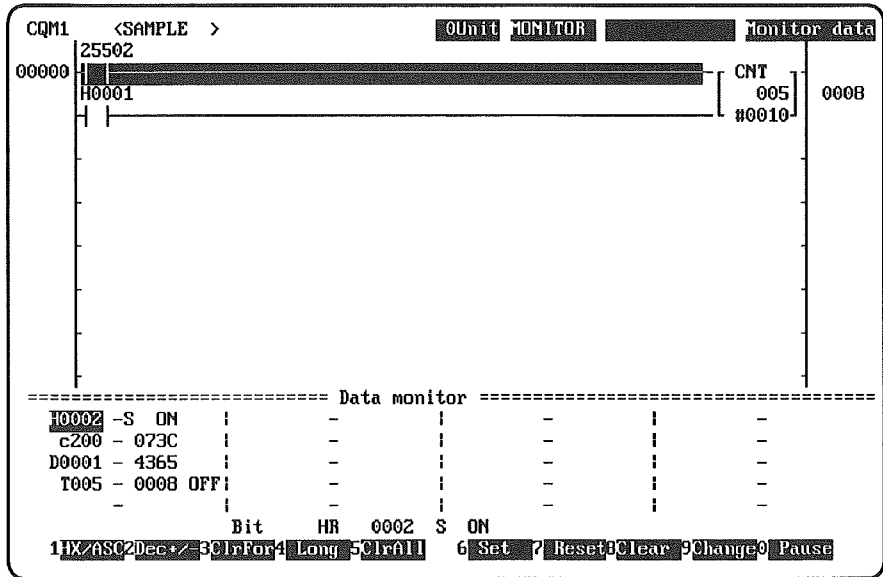

2. Press Escape to release the force-set status of HR 0002.

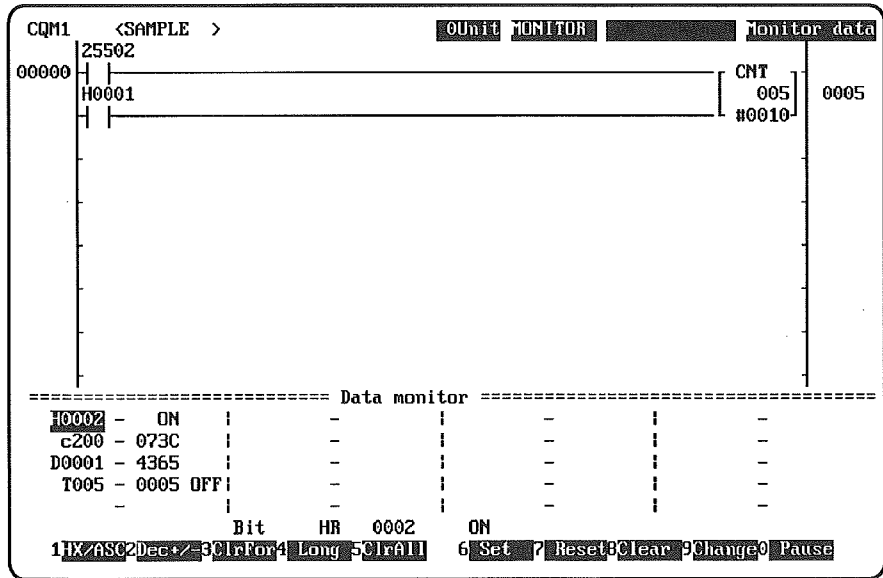

**Release All Bits** The following example shows how to release the forced status of all bits.

- 1, 2, 3... 1. Press F5. A confirmation prompt will be displayed.
2. Press Enter to clear the forced status of all bits.

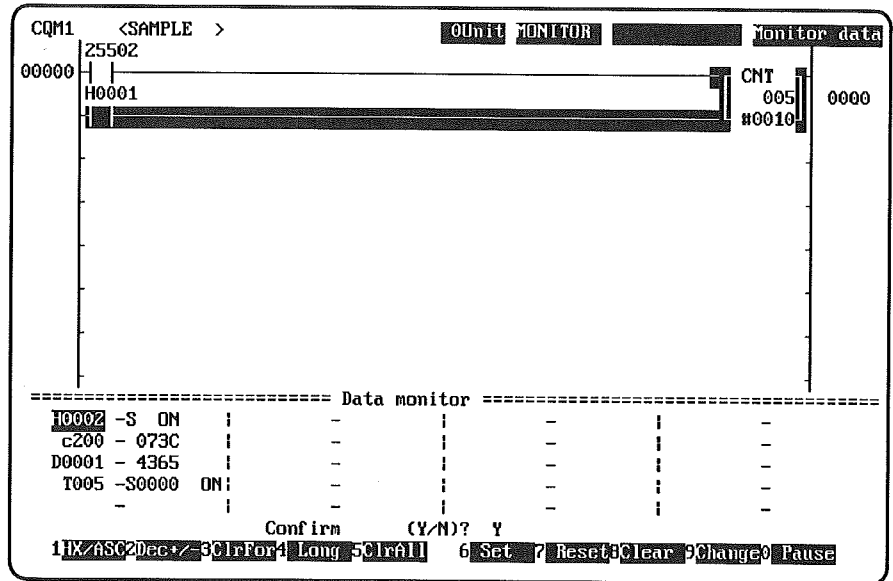

### 10-10-10 Changing Present Values

The F9 Key allows the present value of a timer or counter, or content of a word to be changed. This operation is possible with the PC in MONITOR or PROGRAM mode.

**Caution** Never change the present value of a timer or counter without first confirming that no problems will result in the controlled system. Depending on the controlled system, changes to the present value of a timer or counter can have serious and unexpected results.

Timer and counter PVs must be changed in decimal between 0000 and 9999, but new word data can be entered in hexadecimal, binary, or ASCII.

After pressing F9, press the Tab Key once to input data in binary, twice to input data in ASCII.

Press the F1 Key to display the data in ASCII before inputting ASCII data.

Timer and counter SVs cannot be changed with this operation, they must be changed from the monitoring display. See 10-2-2 Function Keys for details.

The DM (EM) data in the system work area won't be affected even if the content of a DM (EM) word is changed on screen.

**Hexadecimal Data Input** The following example shows how to change the hexadecimal content of IR 200 to 123F.

- 1, 2, 3... 1. Move the cursor to IR 200 and press F9.

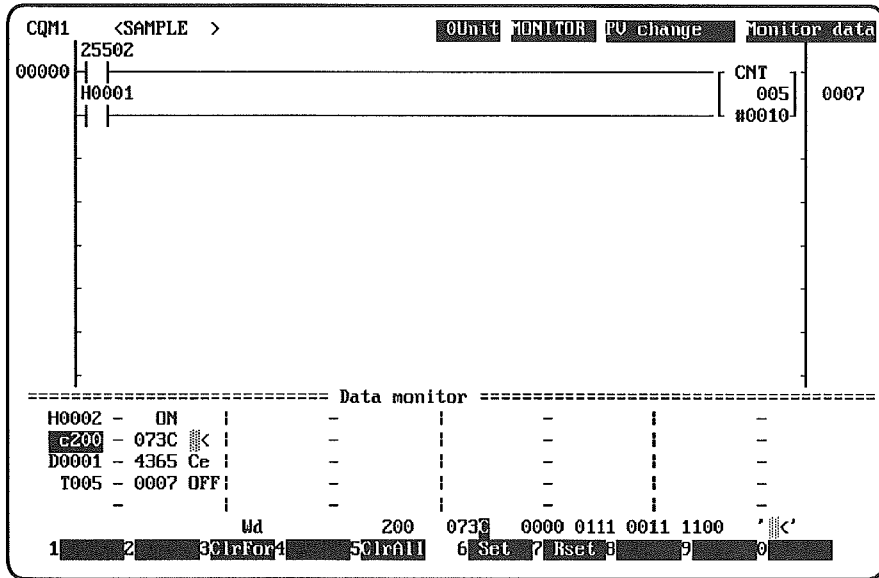

2. Input the new value for IR 200 by pressing 123F and Enter.

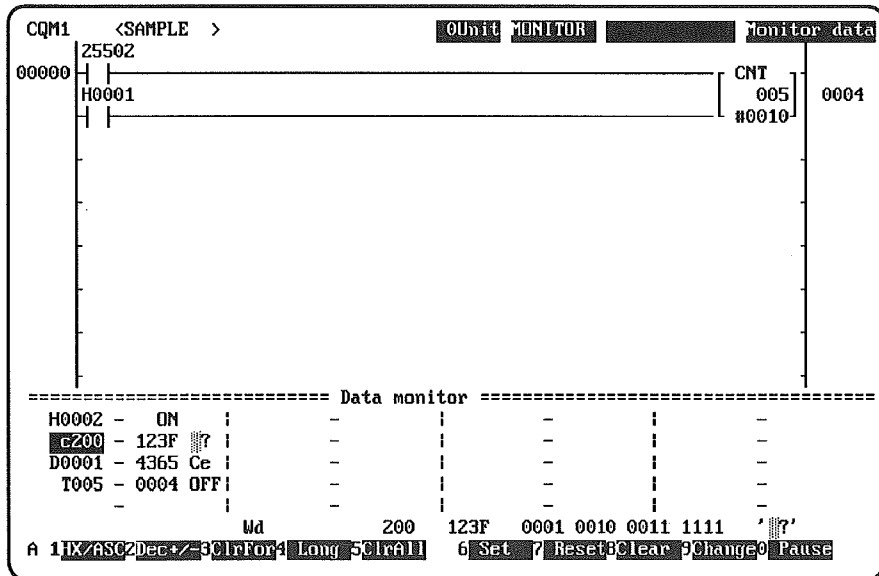

**Binary Data Input** The following example shows how to change the binary content of IR 200 to 0001001000111111.

- 1, 2, 3... 1. Move the cursor to IR 200 and press F9.  
 2. Press the Tab Key once to switch to binary input.  
 3. Input the new value for IR 200 by pressing 0001001000111111 and Enter.

## 10-10-11 Pause

The F10 key allows PC monitoring to be frozen at any point, while allowing the PC to continue operating. To use the pause command, the PC should be in either RUN or MONITOR mode. While the monitor is paused, the Function Keys have the following functions.

| Key | Display | Functions   |
|-----|---------|---|
| F6  | DIFU    | Stops when the bit is ON.<br><br>Press Ctrl+F9, specify the data area and address of the bit, and then press F6 and Enter. PC monitoring will start again and then stop when the designated bit turns ON.<br><br>Once monitoring stops, F10 can be used to start it again until the next time the bit comes ON.   |
| F7  | DIFD    | Stops when the bit is OFF.<br><br>Press Ctrl+F9, specify the data area and address of the bit, and then press F7 and Enter. PC monitoring will start again and then stop when the designated bit turns OFF.<br><br>Once monitoring stops, F10 can be used to start it again until the next time the bit goes OFF. |
| F9  | Pause   | Stops monitoring.   |
| F10 | Begin   | Restarts monitoring.  |

For example, to pause monitoring when the Completion Flag for TIM 10 goes ON, do the following.

Press F10 to display the Pause screen. Input "TIM 10." Press F7 or F6 to halt monitoring when the bit will turn either ON or OFF, respectively. Then press Enter.

## 10-11 Online Editing

The Online Edit operation is used to make simple changes to the PC's program without interrupting its operation in MONITOR mode. Major editing operations such as large scale editing, moving instruction blocks, copying, inserting block programs, and deleting should be done to the program offline and then transferred to the PC.

Online editing can be used with the C1000H/C2000H, CQM1, C200H, or C200HS. It cannot be used with any other PCs. The PC must be in MONITOR or PROGRAM mode. Online editing cannot be used if the PC is in RUN mode.

I/O comments and instruction comments can be edited and written if the ladder diagram is displayed in the ladder with comments format. Block comments can be written, but not edited.

Only one instruction block can be edited at a time. Only NOT designations, bit addresses, and data areas can be changed in block programs.

### Precautions

The following errors can occur during online editing:

1, 2, 3...

1. The programs in the PC and the computer are edited simultaneously and must be identical. A "Verification error" will occur if the programs are different.
2. New instruction blocks can be added after the edited blocks, but the largest program section that can be saved with Store or Store Insert is 128 words. An error will occur if an attempt is made to save a larger program section.
3. A "Cycle time over" error will be generated if instruction block additions or editing cause the PC's cycle time to exceed 100 ms. If this error occurs, check the program and clear the error.
4. Insertion or deletion of the JMP, JME, SBN, END, BPRG, and BEND instructions can stop PC operation for as much as 2 seconds.

**Caution** Never edit a program or other data online without first confirming that no problems will result even if the cycle time is extended. Online editing can cause the cycle time to increase, possibly causing input signals to be read late or not at all. Depending on the controlled system, changes to cycle time can have serious and unexpected results.

### 10-11-1 Online Editing Procedure

- 1, 2, 3...
1. Display the desired instruction block on the lowest part of the screen using the PageUp or PageDown Keys.  
The ladder program must be displayed and monitored on screen in order to execute Online Edit. Online Edit cannot be used to read the program.
  2. Press the End Key to display the Online Menu and select "O:Online edit."
  3. Select the desired instruction block by pressing Enter. The online editing display will appear. Press the End Key to display the Online Edit Menu and press the Escape Key to return to the online editing display.

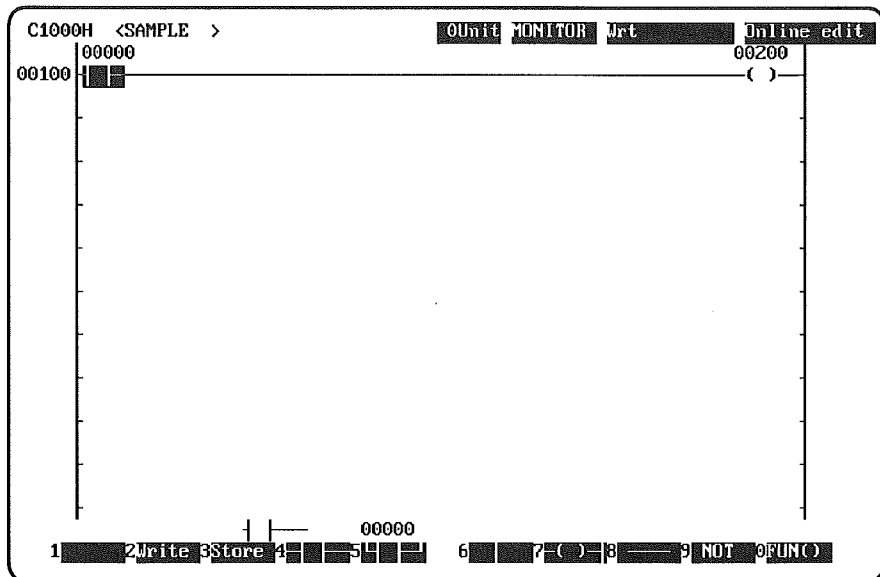

- Another set of functions can be accessed with the Shift Key. Editing of programs is accomplished in the same manner as in offline editing.

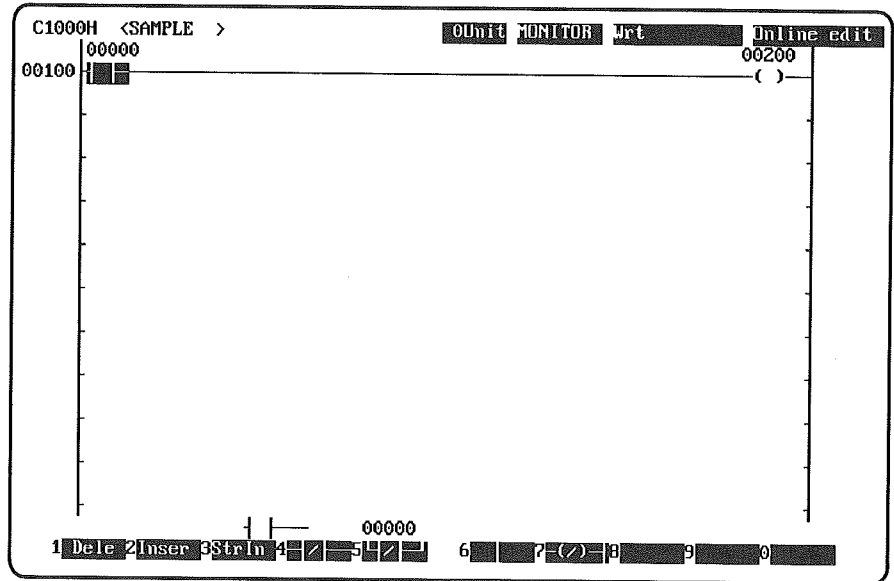

- Save the modified instruction block by pressing F3 (Store) or Shift+F3 (Store insert) and Enter. Data will be written to both the computer's system work area and to the PC's program memory.

### 10-11-2 Online Editing Example

In the following example, online editing is used to add an execution condition and change the bit operand in an output instruction from IR 00500 to IR 00501.

- 1, 2, 3... 1. Display the desired instruction block on the monitoring screen.

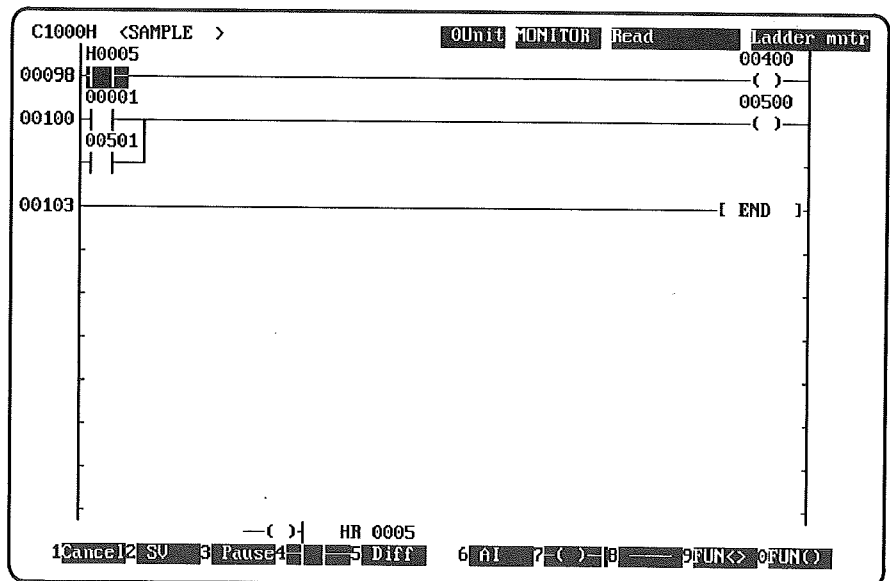



2. Select "O:Online edit" from the Online Menu.

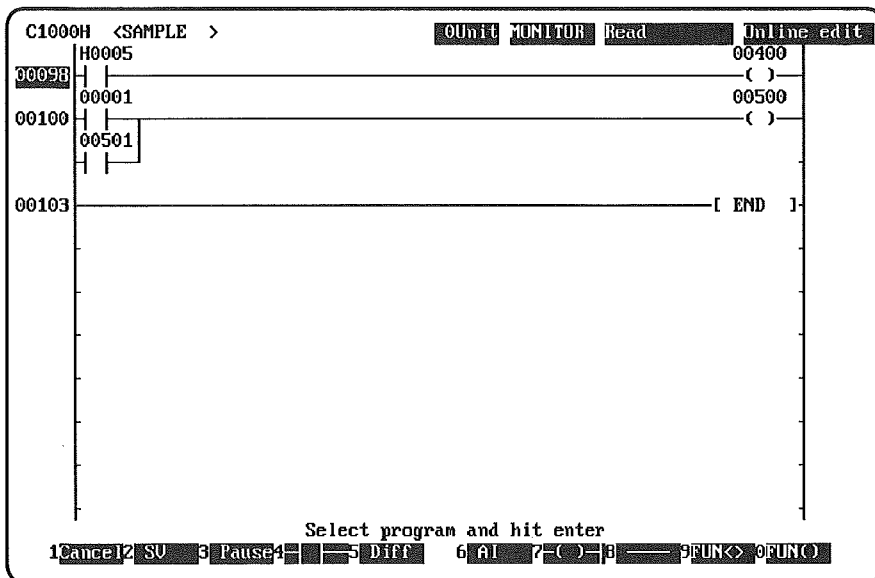

3. Move the cursor to the program address of the instruction block you want to edit and press Enter. In this case, the Down Cursor Key and Enter were pressed.

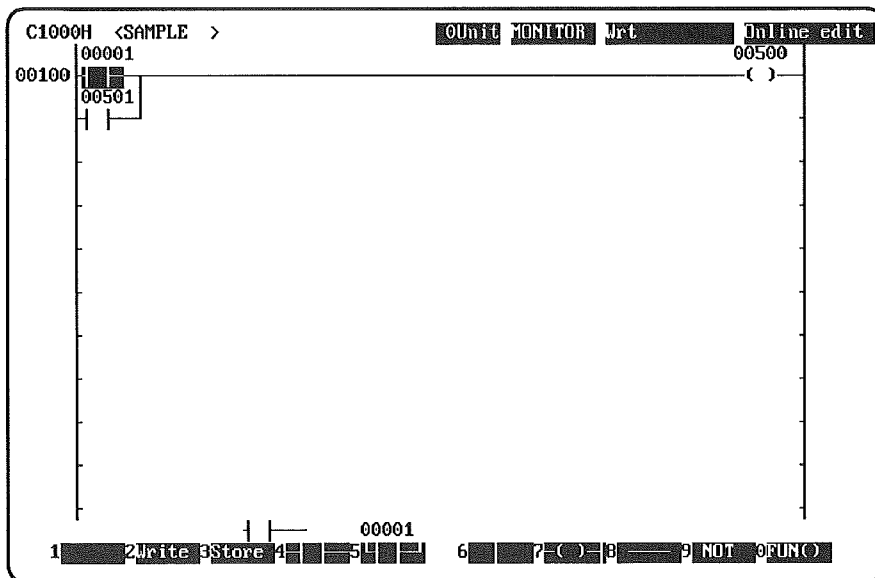

- Edit the instruction block. Press the Right Cursor Key, Shift+F4, 2, and Enter. Press the Left Cursor Key 3 times, 501, and Enter.

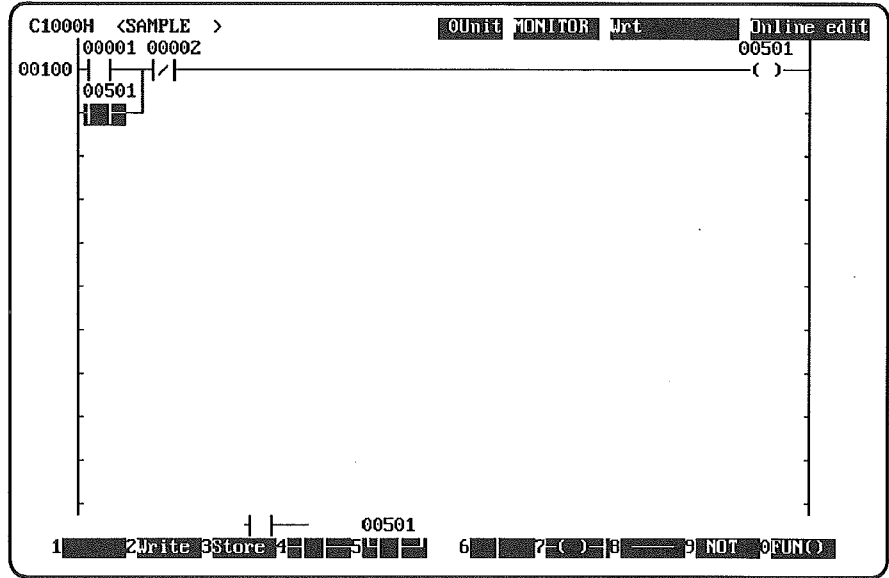

- Save the modified instruction block by pressing F3 (Store) and Enter.

## 10-12 Reading the Cycle Time

The Read Cycle Time operation reads and displays the PC's cycle time. This operation can be executed with the Mini H-type PCs, CQM1, C200H, C200HS, C1000H, and C2000H. The PC can be in either the RUN or MONITOR mode.

Select "Y:Read cycle time" from the Online Menu. The newest mean value for the cycle time will be read and displayed in milliseconds.

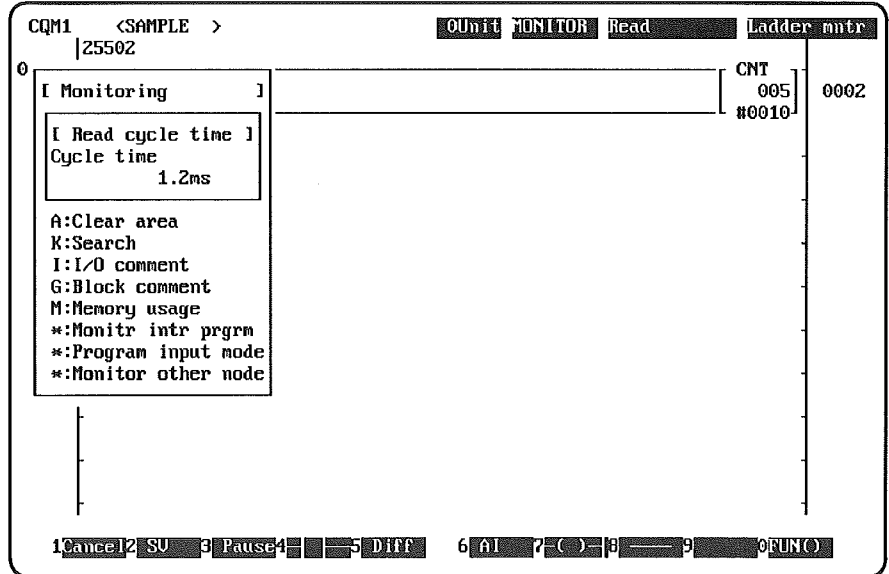

## 10-13 Displaying Memory Usage

The Memory Usage operation displays the contents of the computer's memory. It will display the amount of program memory used, the number of comments used, and the percentage of unused RAM available.

- User Program** The User Program value indicates the amount of memory used from the beginning of the program to the first END(01) instruction. If there isn't an END(01) instruction in the program, the maximum capacity for the PC model will be displayed.
- I/O Comments** The I/O Comments value indicates the number of I/O comments used. Up to 3,500 I/O comments can be used.
- Work Space** The Work Space value indicates the percentage of the user program area that is available.
- Procedure** Follow the procedure below to display the memory usage information.

- 1, 2, 3... 1. To check the memory usage, select "M:Memory usage" from the Online Menu. The following display shows a typical result:

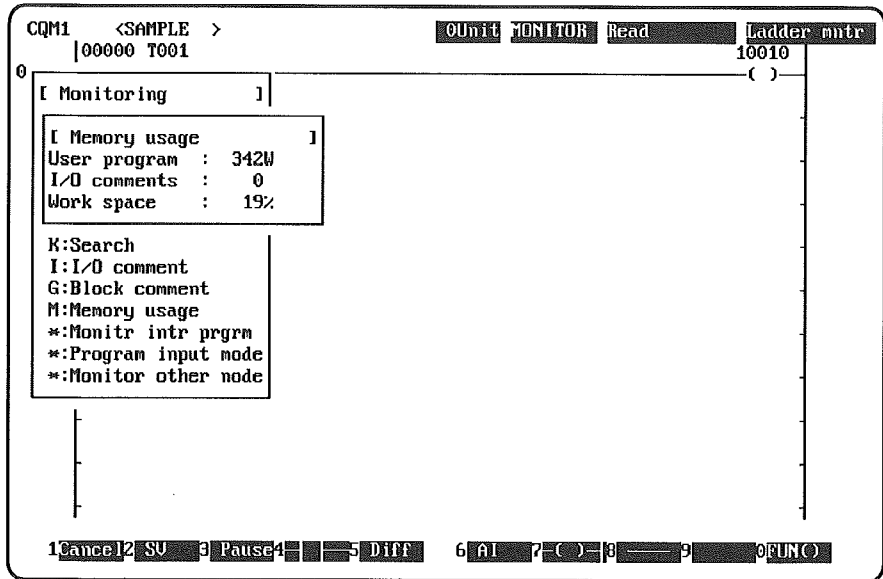

The following display shows the result for a C200HS PC. Refer to 5-14 *Allocating UM* for details on UM allocation in the C200HS.

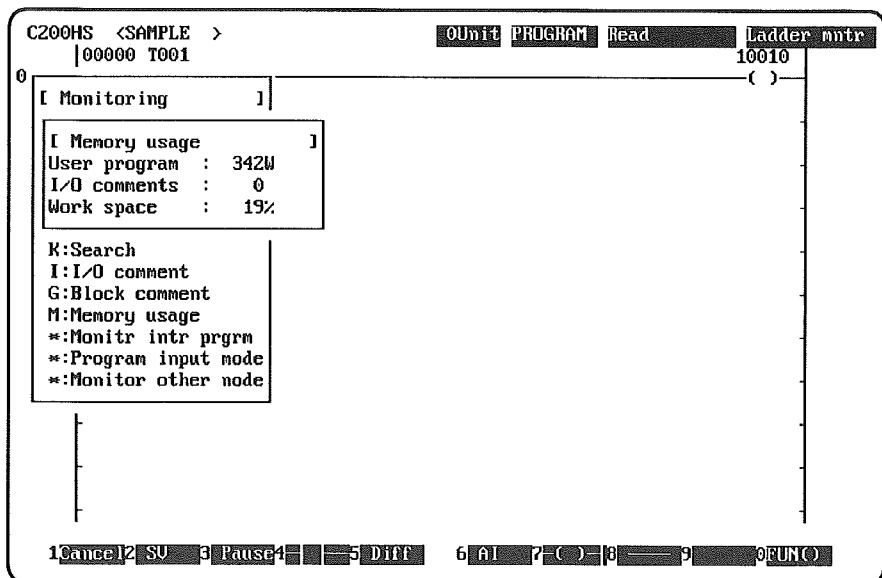

2. Press Escape to return to the Online Menu.



## SECTION 11

### Editing DM

This section explains the commands within the DM Menu. These operations are used to transfer DM area data between the PC and computer, compare the PC's DM data with the computer's DM data, and monitor/edit the PC's DM data.

|        |  |     |
|--------|--|-----|
| 11-1   | The DM Display and DM Menu .....         | 294 |
| 11-1-1 | The DM Display .....                     | 294 |
| 11-1-2 | The DM Menu .....                        | 294 |
| 11-2   | Transferring and Comparing DM Data ..... | 296 |
| 11-2-1 | PC → Computer and Computer → PC .....    | 296 |
| 11-2-2 | Comparing DM Data .....                  | 299 |

## 11-1 The DM Display and DM Menu

### 11-1-1 The DM Display

The DM display appears automatically when DM is selected from the main online menu. Online DM editing operations are the same as the offline operations except the PC's DM data is changed instead of the DM data in the computer's system work area. (Refer to 3-3 *Writing and Editing DM Data* for details on writing or changing DM data.)

C1000H < >
CONTROL MONITOR MONITOR DM HEX

Area D
Data input mode

| Wd   | 0    | 1    | 2    | 3    | 4    | 5    | 6    | 7    | 8    | 9    |  |
|------|------|------|------|------|------|------|------|------|------|------|--|
| 0000 | 0000 | 1111 | 2222 | 3333 | 4444 | 5555 | 6666 | 7777 | 8888 | 9999 | ...."33DDUuffww....                    |
| 0010 | 0000 | 0000 | 0000 | 0000 | 0000 | 0000 | 0000 | 0000 | 0000 | 0000 | .....                                  |
| 0020 | 0000 | 0000 | 0000 | 0000 | 0000 | 0000 | 0000 | 0000 | 0000 | 0000 | .....                                  |
| 0030 | 0000 | 0000 | 0000 | 0000 | 0000 | 0000 | 0000 | 0000 | 0000 | 0000 | .....                                  |
| 0040 | 0000 | 0000 | 0000 | 0000 | 0000 | 0000 | 0000 | 0000 | 0000 | 0000 | .....                                  |
| 0050 | 0001 | 0203 | 0405 | 0607 | 0809 | 0000 | 0000 | 0000 | 0000 | 0000 | .....                                  |
| 0060 | 2021 | 2223 | 2425 | 0000 | 2627 | 2829 | 3031 | 3233 | 3435 | 3637 | ? " # \$ % . , & * ( ) 0 1 2 3 4 5 6 7 |
| 0070 | 6162 | 6364 | 6566 | 6768 | 0040 | 0000 | 0000 | 0000 | 0000 | 0000 | abcdefgh.0.....                        |
| 0080 | 0000 | 0000 | 0000 | 0000 | 0000 | 0000 | 0000 | 0000 | 0000 | 0000 | .....                                  |
| 0090 | 0000 | 0000 | 0000 | 0000 | 0000 | 0000 | 0000 | 0000 | 0000 | 0000 | .....                                  |
| 0100 | 0000 | 0000 | 0000 | 0000 | 0000 | 0000 | 0000 | 0000 | 0000 | 0000 | .....                                  |
| 0110 | 0000 | 0000 | 0000 | 0000 | 0000 | 0000 | 0000 | 0000 | 0000 | 0000 | .....                                  |
| 0120 | 0000 | 0000 | 0000 | 0000 | 0000 | 0000 | 0000 | 0000 | 0000 | 0000 | .....                                  |
| 0130 | 0000 | 0000 | 0000 | 0000 | 0000 | 0000 | 0000 | 0000 | 0000 | 0000 | .....                                  |
| 0140 | 0000 | 0000 | 0000 | 0000 | 0000 | 0000 | 0000 | 0000 | 0000 | 0000 | .....                                  |
| 0150 | 0000 | 0000 | 0000 | 0000 | 0000 | 0000 | 0000 | 0000 | 0000 | 0000 | .....                                  |

1
2
3
4
5
6
7
8
9
0

Data display (hexadecimal)
Data display (ASCII)

### 11-1-2 The DM Menu

Press the End Key with the SSS computer online with the PC, move the cursor to DM, and press Enter to display the DM Menu. This menu is used to monitor and modify DM data in the PC, transfer or compare DM data between the computer and the PC, save or retrieve DM data on a computer floppy disk, or initialize the DM data in the PC.

In addition to normal DM, the online menu can be used with expansion DM in the C200HS and C200HX/HG/HE PCs as well as EM in the C200HX/HG PCs.

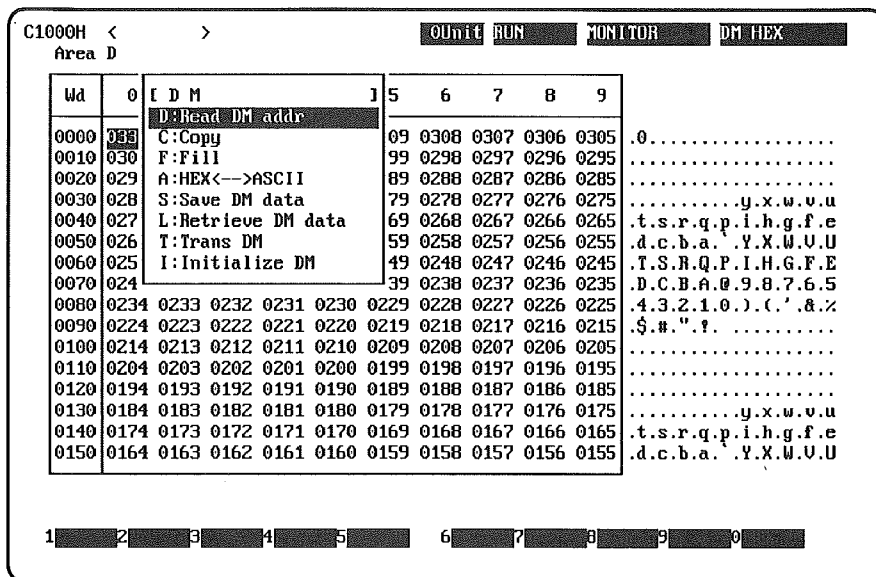

**Operations**

The following table lists the operations that can be selected from the online DM Menu. Online DM operations are the same as the offline operations except the PC's DM data is changed instead of the DM data in the computer's system work area.

Select an operation by pressing its corresponding letter or moving the cursor to the operation and pressing Enter. These operations are described briefly in the following table and in more detail at the location indicated in the last column.

| Operation                       | Function   | Page |
|---------------------------------|--|------|
| D:Read DM address               | Displays the 160-word page of data that contains the specified DM or EM address.   | 115  |
| C:Copy                          | Copies a specified number of consecutive DM or EM words beginning at the specified address.  | 116  |
| F:Fill                          | Places the specified value into consecutive DM or EM words beginning at a specified address.<br>A range of words can be cleared by filling it with 0000. | 116  |
| A:HEX ↔ ASCII                   | Sets input to hexadecimal or ASCII. The selected input mode will be displayed in the top-right of the screen.  | 114  |
| S:Save DM data <sup>1</sup>     | Saves all of the DM and EM data from the PC to the data disk.  | 117  |
| L:Retrieve DM data <sup>2</sup> | Retrieves all DM and EM data from the data disk to the PC.   | 119  |
| T:Transfer                      | Transfers and compares DM and EM data between the computer and PC.   | 296  |
| I:Initialize DM data            | Initializes all DM and EM data in the system work area to 0000.  | 123  |

**Note**

1. The online Save DM data operation saves all of the PC's DM and EM data. The Partial Save operation is available as an offline operation only.
2. The online Retrieve DM data operation retrieves all of the PC's DM and EM data. The Append operation is available as an offline operation only.
3. With CQM1, C200HS, and C200HX/HG/HE PCs, the PC system area data cannot be overwritten.

**Compatible PC Modes**

The following table shows the PC modes in which each operation can be executed.

| Operation            |               | RUN | MONITOR | PROGRAM |
|----------------------|---------------|-----|---------|---------|
| D:Read DM address    |               | OK  | OK      | OK      |
| C:Copy               |               | No  | OK      | OK      |
| F:Fill               |               | No  | OK      | OK      |
| A:HEX ↔ ASCII        |               | OK  | OK      | OK      |
| S:Save DM data       |               | OK  | OK      | OK      |
| L:Retrieve DM data   |               | No  | OK      | OK      |
| T:Transfer           | Computer → PC | No  | No      | OK      |
|                      | PC → Computer | OK  | OK      | OK      |
|                      | Compare       | OK  | OK      | OK      |
| I:Initialize DM data |               | No  | OK*     | OK      |

**Note** In the C200HS, C200HX/HG/HE, and CQM1 PCs, the Initialize DM data command can be executed while the PC is in PROGRAM mode only.

The following table shows the PC modes in which DM data can be edited. (Refer to 3-3 *Writing and Editing DM Data* for details on writing or changing DM data.)

| Operation                  | RUN | MONITOR | PROGRAM |
|----------------------------|-----|---------|---------|
| Editing or Writing DM data | No  | OK      | OK      |

## 11-2 Transferring and Comparing DM Data

The Transfer menu has three operations, one transfers DM data from the PC to the computer's system work area, another transfers DM data from the computer's system work area to the PC's DM area, and the third compares the DM data in the PC to that in the computer's system work area.

These operations can be used to transfer or compare expansion DM data (DM 7000 to DM 9999) in C200HS and C200HX/HG/HE PCs as well as EM area data in C200HX/HG PCs, but the PC Setup operation in the Utility Menu must be used to transfer the PC Setup between the computer and a CQM1, C200HS, or C200HX/HG/HE PC.

### 11-2-1 PC → Computer and Computer → PC

The PC → Computer operation is used to transfer DM data from the PC to the computer's system work area and the Computer → PC operation is used to transfer DM data from the computer's system work area to the PC's DM area. The procedure is as follows:



- 1, 2, 3... 1. Select "T:DM Transfer" from the DM Menu.

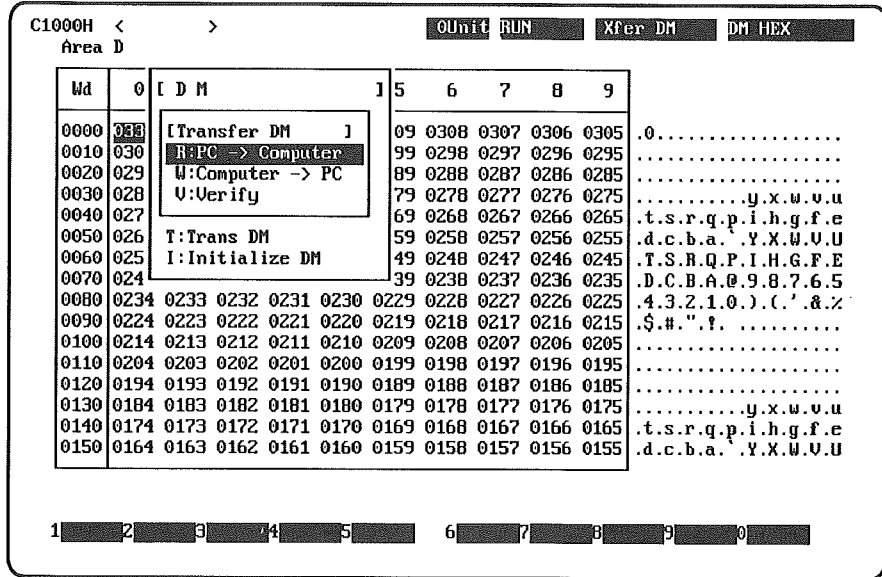

2. Select "R: PC → Computer" to transfer data to the computer or "W: Computer → PC" to transfer data to the PC. An input area for the beginning and end words of the range will appear.
  3. Enter "Y" to accept the current settings.
- or Enter "N" to change the settings, input the desired beginning and end words, and then enter "Y" to accept the displayed settings. The DM data will be transferred when the beginning and end word settings are confirmed.

**Note** Refer to 3-4 Reading DM Data for details on inputting EM addresses.

**Transferring Expansion DM**

When expansion DM data (DM 7000 to DM 9999) is transferred between the computer and a C200HS or C200HX/HG/HE PC, the amount of UM allocated to expansion DM should be the same in the computer and PC.

If the amount of expansion DM allocated in the PC doesn't match the amount allocated in the computer, an error message will be displayed and the smaller of the two settings will be used in the transfer operation. Refer to 5-14 Allocating UM for details on changing the amount of UM allocated to expansion DM.

Two examples of mismatched expansion DM areas are shown below.

- 1, 2, 3... 1. In this example, the smaller setting is 0, so none of the expansion DM data would be transferred.

C200HS < > PROGRAM MONITOR DM HEX  
Area D

| Wd   | 0   | [ D M ]                     | 5  | 6    | 7    | 8    | 9    |  |
|------|-----|-----------------------------|----|------|------|------|------|--|
| 0000 | 000 | D:Read DM addr              | 00 | 0000 | 0000 | 0000 | 0000 |  |
| 0010 | 000 | C:Copy                      | 00 | 0000 | 0000 | 0000 | 0000 |  |
| 0020 | 000 | F:Fill                      | 00 | 0000 | 0000 | 0000 | 0000 |  |
| 0030 | 000 | A:HEX<-->ASCII              | 00 | 0000 | 0000 | 0000 | 0000 |  |
| 0040 | 000 | S:Save DM data              | 00 | 0000 | 0000 | 0000 | 0000 |  |
| 0050 | 0   | L:Retrieve DM data          | 00 | 0000 | 0000 | 0000 | 0000 |  |
| 0060 | 0   | UM allocation differ        |    |      |      |      |      |  |
| 0070 | 0   |                             |    |      |      |      |      |  |
| 0080 | 0   |                             |    |      |      |      |      |  |
| 0090 | 0   | Expansion DM area size      |    | P C  |      | Comp |      |  |
| 0100 | 0   |                             |    | 1KW  |      | 0KW  |      |  |
| 0110 | 0   |                             |    |      |      |      |      |  |
| 0120 | 0   | XDM will not be transferred |    |      |      |      |      |  |
| 0130 | 0   |                             |    |      |      |      |      |  |
| 0140 | 0   | Press any key               |    |      |      |      |      |  |
| 0150 | 0   |                             |    |      |      |      |      |  |

1 2 3 4 5 6 7 8 9 0

2. In this example, the smaller setting is 1K words, so DM 7000 through DM 7999 would be transferred.

C200HS < > PROGRAM MONITOR DM HEX  
Area D

| Wd   | 0   | [ D M ]                | 5  | 6                | 7    | 8    | 9    |  |
|------|-----|------------------------|----|------------------|------|------|------|--|
| 0000 | 000 | D:Read DM addr         | 00 | 0000             | 0000 | 0000 | 0000 |  |
| 0010 | 000 | C:Copy                 | 00 | 0000             | 0000 | 0000 | 0000 |  |
| 0020 | 000 | F:Fill                 | 00 | 0000             | 0000 | 0000 | 0000 |  |
| 0030 | 000 | A:HEX<-->ASCII         | 00 | 0000             | 0000 | 0000 | 0000 |  |
| 0040 | 000 | S:Save DM data         | 00 | 0000             | 0000 | 0000 | 0000 |  |
| 0050 | 0   | L:Retrieve DM data     | 00 | 0000             | 0000 | 0000 | 0000 |  |
| 0060 | 0   | UM allocation differ   |    |                  |      |      |      |  |
| 0070 | 0   |                        |    |                  |      |      |      |  |
| 0080 | 0   |                        |    |                  |      |      |      |  |
| 0090 | 0   | Expansion DM area size |    | P C              |      | Comp |      |  |
| 0100 | 0   |                        |    | 1KW              |      | 2KW  |      |  |
| 0110 | 0   |                        |    |                  |      |      |      |  |
| 0120 | 0   | Transferable XDM area  |    | DM7000 to DM7999 |      |      |      |  |
| 0130 | 0   |                        |    |                  |      |      |      |  |
| 0140 | 0   | Press any key          |    |                  |      |      |      |  |
| 0150 | 0   |                        |    |                  |      |      |      |  |

1 2 3 4 5 6 7 8 9 0

### 11-2-2 Comparing DM Data

The Verify operation is used to compare the contents of a range of DM words in the PC with the corresponding DM words in the computer's system work area. If any differences are found, those DM words will be displayed as shown in the following diagram.

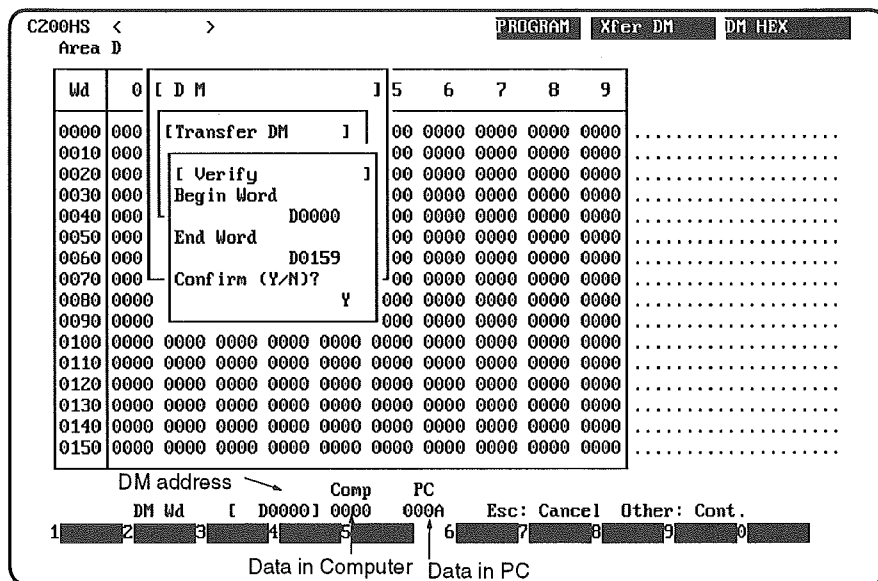

At this point, press any key (except Escape) to continue the Verify operation. Press the Escape Key to return to the DM Transfer Menu.

**Procedure**

The procedure is as follows:

1, 2, 3...

1. Select "T:DM Transfer" from the DM Menu.
  2. Select "V: Verify" from the DM Transfer Menu. An input area for the beginning and end words of the range will appear.
  3. Enter "Y" to accept the current settings.
- or Enter "N" to change the settings, input the desired beginning and end words, and then enter "Y" to accept the displayed settings. The DM data will be compared when the beginning and end word settings are confirmed.

**Note** Refer to 3-4 Reading DM Data for details on inputting EM addresses.



## SECTION 12

### Editing I/O Tables

This section explains the various commands within the I/O Table Menu. These operations can be used to create, edit, and transfer the PC's I/O table from the computer. The I/O table in a C200H, C200HS, or C200HX/HG/HE PC can be cleared.

I/O tables are not used by the C20, P-type, K-type, or CQM1 PCs.

|        |                                       |     |
|--------|---------------------------------------|-----|
| 12-1   | Introduction                          | 302 |
| 12-1-1 | I/O Table Menu                        | 302 |
| 12-1-2 | Displaying the PC's I/O Table         | 303 |
| 12-2   | Creating I/O Tables                   | 304 |
| 12-2-1 | Creating I/O Tables                   | 304 |
| 12-3   | Changing I/O Tables                   | 305 |
| 12-4   | Verifying I/O Tables                  | 307 |
| 12-5   | Transferring and Comparing I/O Tables | 307 |
| 12-5-1 | Transferring to the Computer          | 307 |
| 12-5-2 | Transferring to the PC                | 308 |
| 12-5-3 | Comparing I/O Tables                  | 308 |
| 12-6   | Clearing I/O Tables                   | 308 |
| 12-7   | Replacing I/O Units during Operation  | 308 |

## 12-1 Introduction

All online I/O table operations, except the transfer operation, operate on the PC's I/O table. Use the offline operations to display and edit data from the computer's system work area. The transfer operation can be used to keep the same I/O table data in the PC and the system work area.

### 12-1-1 I/O Table Menu

The I/O Table Menu is displayed when "I/O table" is selected from the top-level online menu.

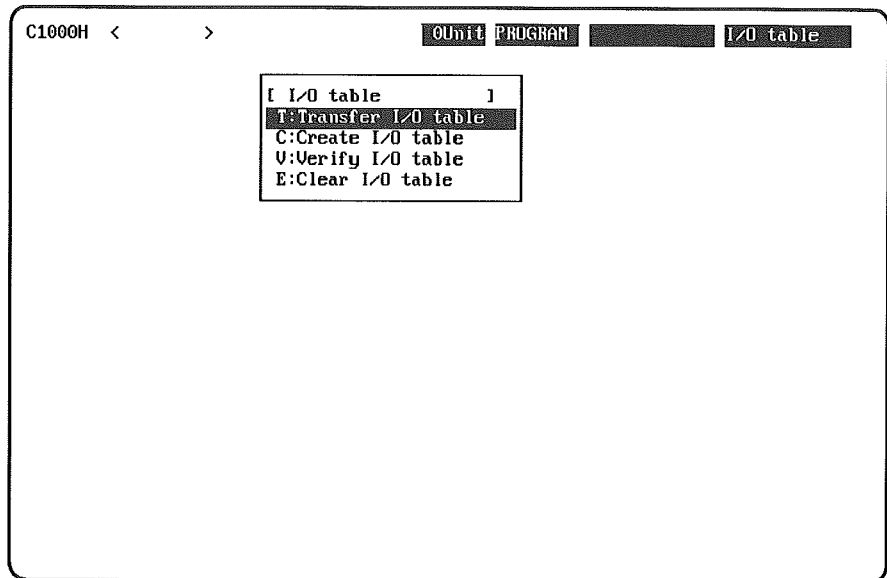

The following table lists the operations that can be selected from the I/O Table Menu. Select an operation by pressing its corresponding letter or moving the cursor to the operation and pressing Enter. These operations are described briefly in the following table and in more detail in later sections. The following table also shows the PC modes in which each operation can be executed.

| Operation            |                 | Function   | RUN | MONITOR | PROGRAM |
|----------------------|-----------------|--|-----|---------|---------|
| T:Transfer I/O table | R:PC → Computer | Writes the I/O table from the PC to the computer.                                  | OK  | OK      | OK      |
|                      | W:Computer → PC | Writes the I/O table from the computer to the PC.                                  | No  | No      | OK      |
|                      | V:Compare       | Compares the I/O tables in the computer and PC.                                    | OK  | OK      | OK      |
| C:Create I/O table   |                 | Registers the actual Units mounted to the PC in the PC's I/O table.                | No  | No      | OK      |
| V:Verify I/O table   |                 | Compares the contents of the PC's I/O table to the actual Units mounted to the PC. | OK  | OK      | OK      |
| E:Clear I/O table    |                 | Clears the contents of the PC's I/O table.   | No  | No      | OK      |

## 12-1-2 Displaying the PC's I/O Table

The PC's I/O table is displayed automatically when "Transfer I/O table" or "Create I/O table" is selected from the I/O Table Menu. The rack number on the left side of the screen indicates the number of the rack which is currently being displayed.

You can press the F3 key to enter the rack number of a rack you want to display or use the PageUp and PageDown keys to scroll up and down through the rack displays.

C1000H < > 0Unit PROGRAM Read I/O table

|          | 0                     | 1    | 2    | 3    | 4    | 5    | 6    | 7    | (Unit) |
|----------|-----------------------|------|------|------|------|------|------|------|--------|
| Rack0    |                       |      |      |      | c007 | c009 |      |      | (Wd)   |
| Rack1    | ****                  | **** | **** | RM0  | **** | OI** | II** | **** |        |
| Rack2    |                       |      |      |      |      |      |      |      |        |
| Rack3    | Master rack RM 0 RT 0 |      |      |      |      |      |      |      |        |
|          | 0                     | 1    | 2    | 3    | 4    | 5    | 6    | 7    | (Unit) |
|          | c000                  |      | c001 |      |      |      |      |      | (Wd)   |
| Rack4    | O***                  | **** | II** | **** | **** | **** | **** | **** |        |
| Rack5    |                       |      |      |      |      |      |      |      |        |
| Rack6    | Master rack RM 0 RT 1 |      |      |      |      |      |      |      |        |
|          | 0                     | 1    | 2    | 3    | 4    | 5    | 6    | 7    | (Unit) |
|          | c003                  | c005 |      |      |      |      |      |      | (Wd)   |
| Rack7    |                       |      |      |      |      |      |      |      |        |
| 8Opt I/O | OO**                  | OO** | **** | **** | **** | **** | **** | **** |        |

RM??-Rem Mast  
└BP No.  
└Rem No.  
INT?-INT unit  
└INT No.  
I: Input  
O: Output  
N: Reserved  
\*: None

1 Chng 2Xchng 3RackNo 4 5 6 7 8 9 0

**Display Codes** The following table shows the I/O table display codes for I/O Units.

| I/O Unit                | Display code |
|-------------------------|--------------|
| Empty slot              | ****         |
| 16-point Output Unit    | O***         |
| 16-point Input Unit     | I***         |
| 16-point Dummy Unit     | N***         |
| 32-point Output Unit    | OO**         |
| 32-point Input Unit     | II**         |
| 32-point Mixed I/O Unit | OI**         |
| 32-point Dummy Unit     | NN**         |
| 64-point Output Unit    | OOOO         |
| 64-point Input Unit     | IIII         |
| 64-point Mixed I/O Unit | OIII         |
| 64-point Dummy Unit     | NNNN         |

A display code of "RM##" indicates a Remote I/O Master Unit. The first digit indicates the rack number and the second digit indicates the Master's unit number.

A display code of "INT#" indicates an Interrupt I/O Unit. The digit indicates the interrupt number.

**Function Keys** When the PC's I/O table has been displayed, function keys F1, F2, and F3 can be used to change or replace Units in the I/O table, as shown below.

| Key | Function   |
|-----|--|
| F1  | Used to input or change I/O Units in the I/O tables in both the PC and computer. This function is useful when adding Units or avoiding problems in word allocation when a Unit isn't being used yet.<br><br>Units in the I/O table cannot be changed if the PC is in RUN mode or for PCs other than the C1000H, C2000, or C2000H<br>Refer to 12-3 Changing I/O Tables for details. |
| F2  | Used to replace an I/O Unit during PC operation for C2000 or C2000H PCs.<br>Refer to 12-7 Replacing I/O Units during Operation for details.  |
| F3  | Used to display the I/O table for the specified Rack. Can be used to display the I/O table of empty Racks too.   |

## 12-2 Creating I/O Tables

The Create I/O Table operation is used to generate an I/O table in the PC and the system work area.

This operation is possible only when the PC is in PROGRAM mode.

Refer to 4-4-3 Group-2 Multipoint I/O Units for details on C200H/C200HS, C200HX/C200HG/C200HE Multipoint I/O Units. Refer to 4-4 Writing I/O Tables for details on C200HS, C200HX/C200HG/C200HE Interrupt I/O Units.

### 12-2-1 Creating I/O Tables

The Create I/O Table operation is used to generate an I/O table in the PC based on the Units that are actually connected to the PC; it should be executed when a Unit has been removed from or added to the PC.

**Procedure** The procedure for creating the I/O table is as follows.

- 1, 2, 3... 1. Select "C:Create I/O table" from the I/O Table Menu.

Unit PROGRAM Read I/O table

|                 | 0                     | 1    | 2    | 3    | 4    | 5    | 6    | 7    | (Unit) |
|-----------------|-----------------------|------|------|------|------|------|------|------|--------|
| <b>Rack0</b>    |                       |      |      |      |      | c007 | c009 |      | (Wd)   |
| <b>Rack1</b>    | ****                  | **** | **** | RM0  | **** | OI** | II** | **** |        |
| <b>Rack2</b>    | Master rack RM 0 RT 0 |      |      |      |      |      |      |      |        |
| <b>Rack3</b>    | 0                     | 1    | 2    | 3    | 4    | 5    | 6    | 7    | (Unit) |
|                 | c000                  |      | c001 |      |      |      |      |      | (Wd)   |
| <b>Rack4</b>    | O***                  | **** | II** | **** | **** | **** | **** | **** |        |
| <b>Rack5</b>    | Master rack RM 0 RT 1 |      |      |      |      |      |      |      |        |
| <b>Rack6</b>    | 0                     | 1    | 2    | 3    | 4    | 5    | 6    | 7    | (Unit) |
|                 | c003                  | c005 |      |      |      |      |      |      | (Wd)   |
| <b>Rack7</b>    | O0**                  | O0** | **** | **** | **** | **** | **** | **** |        |
| <b>80pt I/O</b> |                       |      |      |      |      |      |      |      |        |

RM??-Rem Mast  
└─BP No.  
└─Rem No.

INT?-INT unit  
└─INT No.

I: Input  
O: Output  
N: Reserved  
\*: None

1 Chng 2Xchng 3RackNo. 4 5 6 7 8 9 0



A word multiplier must be input when a Slave other than a Slave Rack (such as an I/O Terminal or Programmable Terminal) is connected to a C1000H/C2000H. The following display will appear for word multiplier inputs.

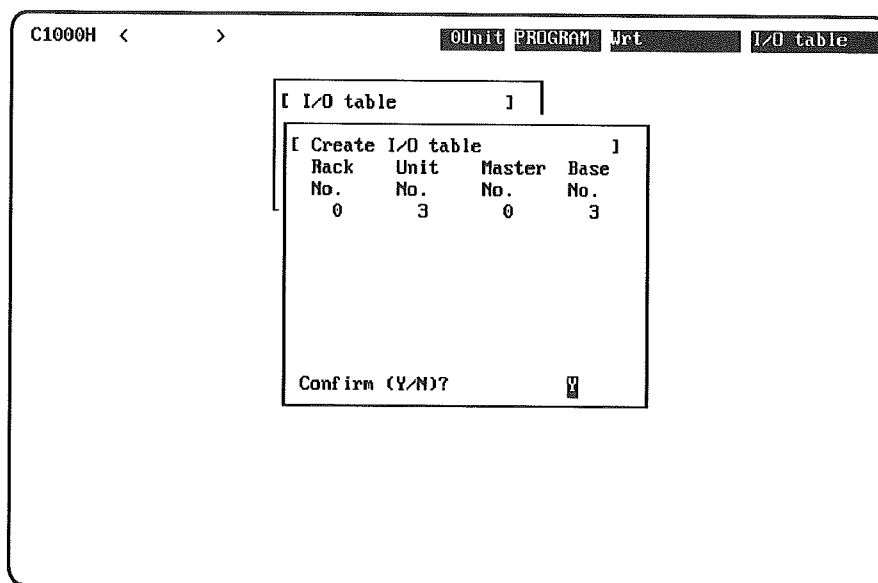

- In most cases, press the Enter Key to continue. Alternatively, press the N and Enter Keys, move the cursor to the desired number, and enter a new word multiplier. The I/O table will be created when the I/O table settings are accepted.

## 12-3 Changing I/O Tables

Pressing F1 during Create I/O Table operation allows changes to be made to the I/O table in C1000H/C2000H PCs.

**Error Messages** An error will occur if the modified I/O table doesn't match the Units actually mounted to the PC. The non-fatal I/O table verification error (I/O Ver Err) occurs when an I/O Unit is placed in an empty I/O table slot. The PC will continue operating.

The fatal input/output I/O table error (I/O Set Error) can occur when a Unit in the I/O table is changed or replaced. The PC will stop operating.

**Function Keys** The following table shows the functions of the function keys and the Home Key when changing the PC's I/O table. I/O words cannot be allocated to Remote I/O Master Units, Optical I/O Units, or Interrupt I/O Units.

| Key  | Function   |
|------|--|
| F1   | Specifies Output Units. An "O" indicates a 16-point Output Unit. |
| F2   | Specifies Input Units. An "I" indicates a 16-point Input Unit.   |
| F3   | Reserves one word.   |
| Home | Clears the slot at the cursor position.                          |

**Example** In the following example, a 64-point Mixed I/O Unit (OOII) is added to slot 2 of Rack 0.

- 1, 2, 3... 1. Select "C:Create I/O table" from the I/O Table Menu. The PC's I/O table will be displayed.
2. Press F1 to change the I/O table.

Unit PROGRAM Img I/O table

|         | 0                     | 1    | 2    | 3    | 4    | 5    | 6    | 7    | (Unit) |
|---------|-----------------------|------|------|------|------|------|------|------|--------|
| Rack0   |                       |      |      |      |      | c007 | c009 |      | (Wd)   |
| Rack1   | ****                  | **** | **** | RM0  | **** | OI** | II** | **** |        |
| Rack2   | Master rack RM 0 RT 0 |      |      |      |      |      |      |      |        |
| Rack3   | 0                     | 1    | 2    | 3    | 4    | 5    | 6    | 7    | (Unit) |
|         | c000                  |      | c001 |      |      |      |      |      | (Wd)   |
| Rack4   | O***                  | **** | II** | **** | **** | **** | **** | **** |        |
| Rack5   | Master rack RM 0 RT 1 |      |      |      |      |      |      |      |        |
| Rack6   | 0                     | 1    | 2    | 3    | 4    | 5    | 6    | 7    | (Unit) |
|         | c003                  | c005 |      |      |      |      |      |      | (Wd)   |
| Rack7   | O***                  | O*** | **** | **** | **** | **** | **** | **** |        |
| 8OptI/O |                       |      |      |      |      |      |      |      |        |

RM??-Rem Mast  
 ↳BP No.  
 ↳Rem No.

INT?-INT unit  
 ↳INT No.

I: Input  
 O: Output  
 N: Reserved  
 \*: None

Select Input/Output

1 OUT
 2 IN
 3 Wd res
 4
5
6
7
8
9
0

3. Press the Right Cursor Key twice to move the cursor to slot 2 of Rack 0.
4. Press the F1 Key twice to specify two 16-point outputs and press the F2 Key twice to specify two 16-point inputs.
5. Press Enter to register the Mixed I/O Unit in the I/O table.

## 12-4 Verifying I/O Tables

The Verify I/O Table operation is used to compare the contents of the PC's I/O table with the actual Units mounted to the PC. The results of the comparison are displayed one Rack at a time and I/O table data is displayed only for slots where differences were found. The PC's I/O table data is displayed in the upper part of the slot and the actual Unit mounted to the PC is displayed in the lower part of the slot.

The "Compare" operation is used to compare the I/O table in the computer's system work area to the I/O table in the PC. Refer to 12-5-3 Comparing I/O Tables for details.

When the PC is a C200H, this operation will not recognize I/O table verification errors for Group-2 Multipoint I/O Units.

- 1, 2, 3...
1. Select "V:Verify I/O table" from the I/O Table Menu.
  2. If differences are found between the PC's I/O table and the actual Units mounted, those differences will be displayed as shown in the following diagram.

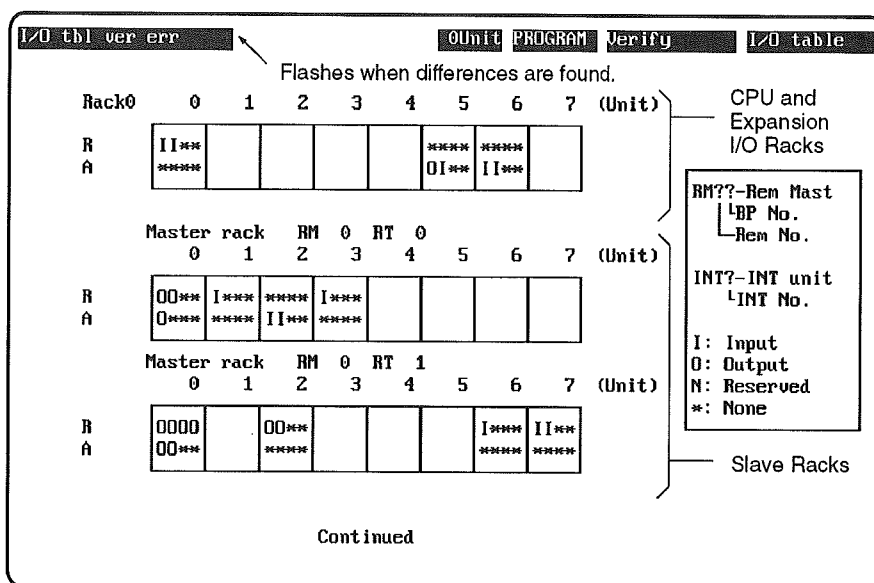

3. If the comparison information cannot be displayed on one screen, press the PageUp and PageDown Keys to scroll through the Racks.

## 12-5 Transferring and Comparing I/O Tables

The three operations in the Transfer I/O Table Menu are used to transfer I/O tables between the computer and PC and compare the I/O table in the computer's system work area with the I/O table in the PC. Use the Verify I/O table operation to compare the PC's I/O table to the Units actually mounted to the PC.

### 12-5-1 Transferring to the Computer

This operation is used to copy the I/O table in the PC to the computer's system work area.

- 1, 2, 3...
1. Select "T:Transfer I/O table" from the I/O Table Menu.
  2. Select "R:PC → Computer" from the menu. The transferred I/O table will be displayed when the transfer has been completed.

## 12-5-2 Transferring to the PC

This operation is used to copy the I/O table in the computer's system work area to the PC. Transfer to the PC is possible only with a C1000H/C2000H PC in PROGRAM mode. The PC cannot have any Remote I/O Masters connected.

- 1, 2, 3...
  1. Select "T:Transfer I/O table" from the I/O Table Menu.
  2. Select "W:Computer → PC" from the menu. The transferred I/O table will be displayed when the transfer has been completed.

## 12-5-3 Comparing I/O Tables

This operation is used to compare the I/O table in the computer's system work area to the I/O table in the PC. This operation is useful when comparing the PC's I/O table to an I/O table created offline in the computer. The computer's I/O table data is displayed in the upper part of the slot and the PC's I/O table data is displayed in the lower part of the slot.

Refer to *12-4 Verifying I/O Tables* for details on the displays.

- 1, 2, 3...
  1. Select "T:Transfer I/O table" from the I/O Table Menu.
  2. Select "V:Compare" from the menu. The comparison results will be displayed when the comparison has been completed.

## 12-6 Clearing I/O Tables

This operation is used to clear the I/O table in a C200H, C200HS, or C200HX/HG/HE PC; it can be executed only when the computer is connected to the PC through a Peripheral Interface Unit.

When the I/O table has been cleared, the PC will operate with the PC's actual I/O table.

Special I/O Units will be reset temporarily when the Clear I/O table operation is executed. Do not execute this operation when any of the following Units is operating:

- Host Link Unit
- PC Link Unit
- Remote I/O Master Unit
- High-speed Counter Unit
- Position Control Unit
- Any other Special I/O Units

**Procedure** The procedure is as follows:

- 1, 2, 3...
  1. Select "E:Clear I/O table" from the I/O Table Menu. A confirmation prompt will be displayed.
  2. Press Enter to clear the I/O table. Press "N" and Enter to cancel the operation. The message "Erased" will be displayed when the I/O table has been cleared.

## 12-7 Replacing I/O Units during Operation

Pressing F2 during when the I/O table is displayed allows I/O Units on a C2000H (or C2000) PC to be replaced during operation. The C2000H PC must be equipped with a C2000-IOD01 or C2000-IOD02 I/O Remove Auxiliary Unit and the I/O Unit being replaced must be mounted on the CPU Rack or and Expansion I/O Rack.

Only one Unit can be replaced at a time and the new I/O Unit must be the same model as the one being replaced. The replacement cannot be performed if the new I/O Unit doesn't have the same number and type of I/O points.

**Example** In the following example, a 16-point Input Unit is replaced in slot 6 of Rack 0.

- 1, 2, 3...
  1. Select "C:Create I/O table" from the I/O Table Menu. The PC's I/O table will be displayed.

2. Press F2 to replace an I/O Unit.

```

C1000H < >          OUnit PROGRAM Xchg I/O table
  0  1  2  3  4  5  6  7 (Unit)
  Rack0 c007 c009 (Wd)
  Rack1 **** ** RM0 **** OI** II** ****
  Rack2 Master rack RM 0 RT 0
  Rack3 0 1 2 3 4 5 6 7 (Unit)
  Rack4 c000 c001 (Wd)
  Rack5 O*** ** II** **** **** **** ****
  Rack6 Master rack RM 0 RT 1
  Rack7 0 1 2 3 4 5 6 7 (Unit)
  Rack8 c003 c005 (Wd)
  BOptI/O O0** 00** **** **** **** **** ****

  Exchange? OUnit ****
  
```

RM??-Rem Mast  
 ↳BP No.  
 ↳Rem No.

INT?-INT unit  
 ↳INT No.

I: Input  
 O: Output  
 N: Reserved  
 \*: None

3. Press the Right Cursor Key 6 times to move the cursor to slot 6 of Rack 0, and then press Enter.

```

C1000H < >          OUnit PROGRAM Read I/O table
  0  1  2  3  4  5  6  7 (Unit)
  Rack0 c007 c009 (Wd)
  Rack1 **** ** RM0 **** OI** II** ****
  Rack2 Master rack RM 0 RT 0
  Rack3 0 1 2 3 4 5 6 7 (Unit)
  Rack4 c000 c001 (Wd)
  Rack5 O*** ** II** **** **** **** ****
  Rack6 Master rack RM 0 RT 1
  Rack7 0 1 2 3 4 5 6 7 (Unit)
  Rack8 c003 c005 (Wd)
  BOptI/O O0** 00** **** **** **** **** ****

  Xchg'g      6Unit II**

  1 Chng 2Xchg 3RckNo. 4 5 6 7 8 9 0
  
```

4. Replace the Input Unit and press F2 again.

5. A confirmation prompt will be displayed. Press Enter to continue.



## SECTION 13

# Utility Operations

This section explains the various commands within the Utility Menu. The Utility Menu contains a variety of operations used to debug and control the PC.

|        |  |     |
|--------|--|-----|
| 13-1   | The Utility Menu .....                         | 312 |
| 13-2   | File Memory Operations .....                   | 312 |
| 13-2-1 | File Memory List .....                         | 312 |
| 13-2-2 | Transferring between the Computer and FM ..... | 314 |
| 13-2-3 | Clearing File Memory .....                     | 319 |
| 13-2-4 | Transferring between the PC and FM .....       | 319 |
| 13-2-5 | Transferring between a Disk and FM .....       | 321 |
| 13-3   | Time Chart Monitoring .....                    | 323 |
| 13-3-1 | Execute .....                                  | 324 |
| 13-3-2 | Read .....                                     | 326 |
| 13-3-3 | Retrieve .....                                 | 326 |
| 13-3-4 | Save .....                                     | 327 |
| 13-4   | Instruction Traces .....                       | 327 |
| 13-4-1 | Execute .....                                  | 327 |
| 13-4-2 | Read .....                                     | 330 |
| 13-4-3 | Retrieve .....                                 | 330 |
| 13-4-4 | Save .....                                     | 330 |
| 13-5   | Data Traces .....                              | 330 |
| 13-5-1 | Execute .....                                  | 332 |
| 13-5-2 | Read .....                                     | 334 |
| 13-5-3 | Retrieve .....                                 | 334 |
| 13-5-4 | Save .....                                     | 335 |
| 13-6   | Debugging .....                                | 335 |
| 13-7   | Reading and Setting the Clock .....            | 337 |
| 13-8   | Transferring Expansion Instructions .....      | 337 |
| 13-9   | PC Setup .....                                 | 337 |

## 13-1 The Utility Menu

The Utility Menu is displayed when Utility is selected from the top-level online menu. The following table lists the operations that can be selected from the Utility Menu. Select an operation by pressing its corresponding letter or moving the cursor to the operation and pressing Enter. These operations are described briefly in the following table and in more detail in later sections.

| Operation              | Function   |
|------------------------|--|
| F:File Memory/Mem Card | Transfers and compares files in a C1000H/C2000H File Memory Unit.  |
| C:Time chart monitor   | Monitors the operation of the PC in a time-chart format.   |
| S:Instruction trace    | Monitors program execution by displaying instructions in the order they were executed.   |
| T:Data trace           | Records the status of a bit or content of a word at fixed intervals.   |
| D:Debug                | Monitors bit status or word content as the program is executed.  |
| K:Display/Set Clock    | Reads or sets the PC's internal clock.   |
| A:Transfer instr       | Transfers the expansion instructions from the CQM1 or C200HS to the computer. (Refer to 5-12 <i>Expansion Instructions</i> for details.) |
| Q:PC setup             | Sets or transfers the PC Setup parameters. (Refer to 5-13 <i>PC Setup</i> for details.)  |
| W:Net support table    | Transfers the SYSMAC NET Link or SYSMAC LINK data link tables. Starts/stops the data link.   |

## 13-2 File Memory Operations

A File Memory Unit may be attached to a C1000H or C2000H to store programs, DM data, and I/O comments. Before attempting any File Memory Operations, refer to the PC's operation manual and make sure that the File Memory Unit is properly connected to the PC, that communication protocols are set properly, and that the appropriate pins of the File Memory Unit's write-protect switch are turned off to enable writing (if necessary).

The File Memory operations can be used to transfer files between the File Memory Unit and computer, the File Memory Unit and PC, or the File Memory Unit and a disk. These operations are described briefly in the following table and in more detail in later sections.

| Operation           | Function   |
|---------------------|--|
| I:File memory list  | Lists the files in the File Memory Unit.   |
| F:Computer ↔ FM     | Used to transfer and compare files between the computer and File Memory Unit. Also used to edit files. |
| C:Clear file memory | Clears specified blocks (128-word units) of data from the File Memory Unit.                            |
| P:PC ↔ FM           | Used to transfer and compare files between the PC and File Memory Unit.                                |
| D:Floppy ↔ FM       | Used to transfer and compare files between a disk and the File Memory Unit.                            |

### 13-2-1 File Memory List

The File Memory List operation is used to display or print a table showing how the blocks of File Memory are used. Each block of File Memory contains 128 words of data. Use the File Memory List operation to examine the contents of file memory before executing any file transfer or clear operations.



**Procedure** The following procedure shows how to display and print the File Memory list.

- 1, 2, 3... 1. Select "F:File Memory/Mem Card" from the Utility Menu.
2. Select "l:File memory list" from the File Memory Menu. The File Memory list will be displayed. Use the PageUp and PageDown Keys to page through the list.

```

C1000H <SAMPLE >
                * * *          FM list          * * *
                                No (Reverse): Protected
    
```

| No   |     | No   |      | No   |    | No   |      | No   |  | No   |     |
|------|-----|------|------|------|----|------|------|------|--|------|-----|
| 0000 | UM  | 0016 | COM  | 0032 |    | 0048 | UM   | 0064 |  | 0080 |     |
| 0001 | UM  | 0017 | COM  | 0033 |    | 0049 | *UM  | 0065 |  | 0081 |     |
| 0002 | UM  | 0018 | COM  | 0034 |    | 0050 | *COM | 0066 |  | 0082 |     |
| 0003 | UM  | 0019 | COM  | 0035 |    | 0051 | I/O  | 0067 |  | 0083 |     |
| 0004 | UM  | 0020 | COM  | 0036 |    | 0052 |      | 0068 |  | 0084 |     |
| 0005 | UM  | 0021 | COM  | 0037 |    | 0053 |      | 0069 |  | 0085 | UM  |
| 0006 | UM  | 0022 | *COM | 0038 |    | 0054 |      | 0070 |  | 0086 | UM  |
| 0007 | UM  | 0023 | UM   | 0039 |    | 0055 |      | 0071 |  | 0087 | UM  |
| 0008 | *UM | 0024 | UM   | 0040 |    | 0056 |      | 0072 |  | 0088 | UM  |
| 0009 | I/O | 0025 | UM   | 0041 | UM | 0057 |      | 0073 |  | 0089 | UM  |
| 0010 | I/O | 0026 | UM   | 0042 | UM | 0058 |      | 0074 |  | 0090 | UM  |
| 0011 |     | 0027 | UM   | 0043 | UM | 0059 |      | 0075 |  | 0091 | UM  |
| 0012 | COM | 0028 | UM   | 0044 | UM | 0060 |      | 0076 |  | 0092 | UM  |
| 0013 | COM | 0029 | UM   | 0045 | UM | 0061 |      | 0077 |  | 0093 | *UM |
| 0014 | COM | 0030 | UM   | 0046 | UM | 0062 |      | 0078 |  | 0094 | I/O |
| 0015 | COM | 0031 | *UM  | 0047 | UM | 0063 |      | 0079 |  | 0095 | I/O |

1 2 3 4 5 6 7 8 9 0 Print

The following table explains the abbreviations used to describe the blocks. Blocks which are write-protected will be displayed in reverse video. Write-protection is disabled by turning off the corresponding pin on the File Memory Unit's DIP switch.

| Abbreviation | Explanation                                    |
|--------------|--|
| UM           | Program  |
| I/O          | Data from IR, LR, HR, AR, TIM/CNT, or DM areas |
| COM          | I/O comments of up to 10 characters            |
| *            | Indicates the END UM or COM block.             |
| Blank        | Unused   |

3. To display a particular block, input the block number and press Enter.
  4. The F10 Key can be pressed to print a copy of the entire list.
- or To print just the current page, press Ctrl+O and then F10.

Printing can be interrupted by pressing Escape, but printing will continue until the contents of the printer's buffer are exhausted.

An error message will be displayed in the upper-left corner of the screen if the printer is disconnected or unable to print. In this case press Escape, correct the problem, and try printing again.

## 13-2-2 Transferring between the Computer and FM

The Computer ↔ FM operations are used to transfer or compare programs, DM, and I/O comments between the computer and the File Memory. The Edit Block operation is used to edit the contents of I/O blocks. The following table describes the operations in the Computer ↔ FM Menu.

| Operation    | Function   |
|--------------|--|
| P:Program    | Used to transfer and compare programs.   |
| D:DM         | Used to transfer and compare DM.   |
| C:Comment    | Used to transfer and compare I/O comments.   |
| B:Block edit | Used to edit I/O blocks in File Memory.<br>(Unused blocks are also considered I/O blocks.) |

### Program

The Program operations are used to transfer or compare programs between the computer and File Memory.

**FM → Computer** The following procedure transfers programs from File Memory to the computer.

- 1, 2, 3...
1. Select "F:File Memory/Mem Card" from the Utility Menu.
  2. Select "F:Computer ↔ FM" from the File Memory Menu.
  3. Select "P:Program" from the Computer ↔ FM Menu.
  4. Select "R:FM → Computer" from the Program Menu.

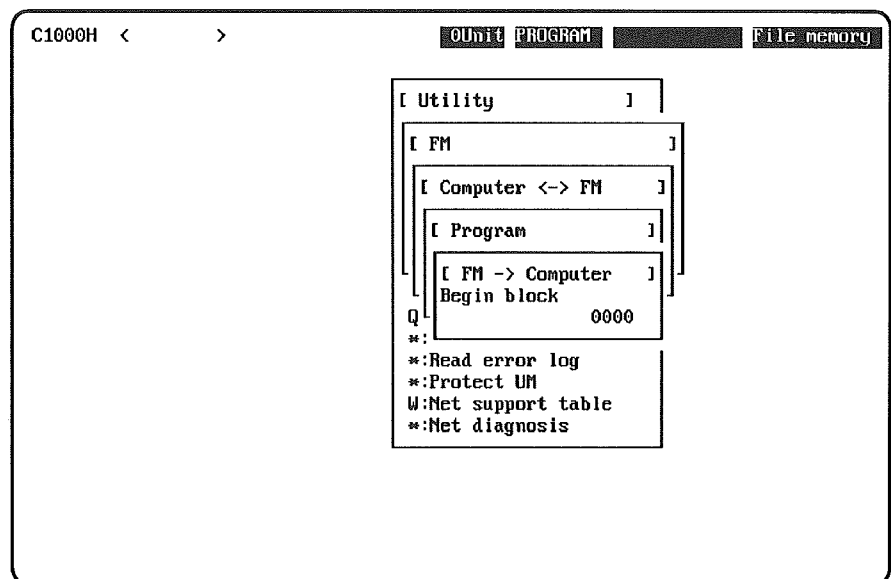

5. Input the block number of the first program block and press Enter. The program will be transferred from the specified block to the block containing the END(01) instruction. (The END block is indicated by \*UM on the File Memory list.)

**Computer → FM** The following procedure transfers programs from the computer to File Memory. A "No END" error will occur if there isn't an END(01) instruction in the program in the computer's system work area.

- 1, 2, 3...
1. Select "F:File Memory/Mem Card" from the Utility Menu.
  2. Select "F:Computer ↔ FM" from the File Memory Menu.
  3. Select "P:Program" from the Computer ↔ FM Menu.
  4. Select "W:Computer → FM" from the Program Menu.

- Input the block number of the first program block and press Enter. The program in the computer's system work area will be transferred to File Memory beginning at the specified block and ending with the END(01) instruction.

**Verification**

The following procedure compares the program in the computer's system work area to one in File Memory. An error will occur if the specified beginning block doesn't contain program (UM) data.

The verification operation will be aborted if an I/O or COM block is encountered before the UM block containing the END(01) instruction (\*UM).

**1, 2, 3...**

- Select "F:File Memory/Mem Card" from the Utility Menu.
- Select "F:Computer ↔ FM" from the File Memory Menu.
- Select "P:Program" from the Computer ↔ FM Menu.
- Select "V:Verify" from the Program Menu.
- Input the block number of the first program block and press Enter. The program in the computer's system work area will be compared to the one in File Memory beginning at the specified block and ending with the END(01) instruction.

**DM**

The DM operations are used to transfer or compare DM data between the computer and File Memory. Other data (IR, LR, HR, AR, and TIM/CNT data) stored in I/O blocks will be treated as DM data, but the transfer or verification operation will be aborted if a UM or COM block is encountered.

**FM → Computer** The following procedure transfers DM from File Memory to the computer.

**1, 2, 3...**

- Select "F:File Memory/Mem Card" from the Utility Menu.
- Select "F:Computer ↔ FM" from the File Memory Menu.
- Select "D:DM" from the Computer ↔ FM Menu.
- Select "R:FM → Computer" from the DM Menu.

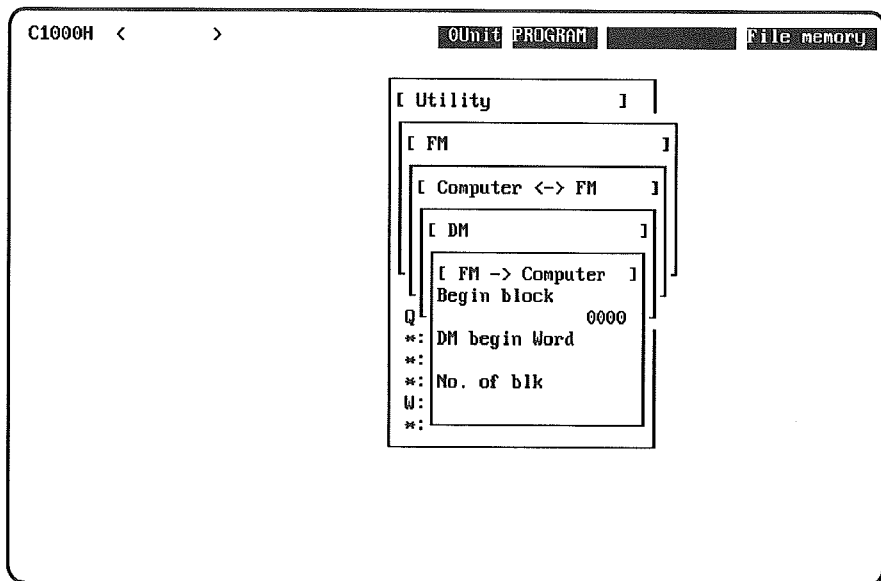

- Input the block number of the first I/O block and press Enter.
- Input the starting DM address and press Enter. DM data from file memory will be written to the computer's system work area beginning at this address.
- Input the number of blocks to be transferred and press Enter. (Each I/O block contains 128 words of DM data.) If 99 is input, DM data will be transferred to the end of the DM area.

**Computer→ FM** The following procedure transfers programs from the computer to File Memory.

- 1, 2, 3...**
1. Select "F:File Memory/Mem Card" from the Utility Menu.
  2. Select "F:Computer ↔ FM" from the File Memory Menu.
  3. Select "D:DM" from the Computer ↔ FM Menu.
  4. Select "W:Computer → FM" from the DM Menu.
  5. Input the block number of the first I/O block containing DM data and press Enter.
  6. Input the starting DM address and press Enter. DM data will be transferred from the computer's system work area beginning at this address.
  7. Input the number of blocks to be transferred and press Enter. (Each I/O block contains 128 words of DM data.) If 99 is input, DM data will be transferred to the end of the DM area.

**Verification** The following procedure compares DM data in the computer's system work area to DM data stored in File Memory. An error will occur if the specified beginning block isn't an I/O block. The verification operation will be aborted if a UM or COM block is encountered during verification.

- 1, 2, 3...**
1. Select "F:File Memory/Mem Card" from the Utility Menu.
  2. Select "F:Computer ↔ FM" from the File Memory Menu.
  3. Select "D:DM" from the Computer ↔ FM Menu.
  4. Select "V:Verify" from the DM Menu.
  5. Input the block number of the first I/O block containing DM data and press Enter.
  6. Input the starting DM address and press Enter. DM data in the computer's system work area will be compared beginning at this address.
  7. Input the number of blocks to be compared and press Enter. (Each I/O block contains 128 words of DM data.) If 99 is input, DM data will be compared to the end of the DM area.

The contents of the File Memory word and DM area word will be displayed if they are different. Press Escape to cancel the verification operation. Press any other key to continue.

### Comments

The Comment operations are used to transfer or compare I/O comments between the computer and File Memory. The transfer or verification operation will be aborted if an I/O or UM block is encountered during the operation.

A COM block contains 21 I/O comments of up to 10 characters each.

**FM→ Computer** The following procedure transfers I/O comments from File Memory to the computer.

- 1, 2, 3...**
1. Select "F:File Memory/Mem Card" from the Utility Menu.
  2. Select "F:Computer ↔ FM" from the File Memory Menu.
  3. Select "C:Comment" from the Computer ↔ FM Menu.

4. Select "R:FM → Computer" from the Comment Menu.

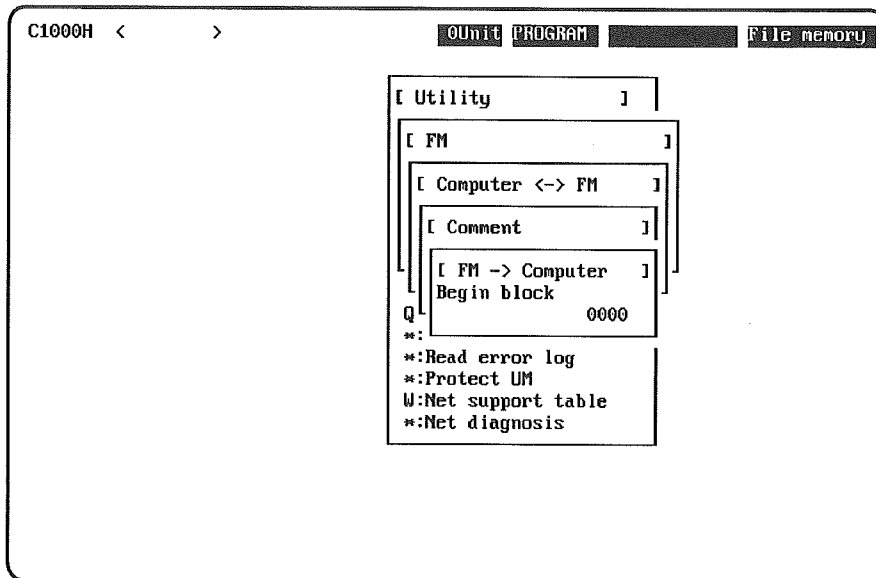

5. Input the block number of the first program block and press Enter. The program will be transferred from the specified block to the block containing the END(01) instruction. (The END block is indicated by \*COM on the File Memory list.)

**Computer→ FM** The following procedure transfers I/O comments from the computer to File Memory. Any data in the File Memory will be overwritten.

This operation cannot be performed when the PC is operating.

A COM block contains 21 I/O comments of up to 10 characters each. If an I/O comment contains more than 10 characters, the excess characters won't be transferred.

1, 2, 3...

1. Select "F:File Memory/Mem Card" from the Utility Menu.
2. Select "F:Computer ↔ FM" from the File Memory Menu.
3. Select "C:Comment" from the Computer ↔ FM Menu.
4. Select "W:Computer → FM" from the Comment Menu.
5. Input the block number of the first block and press Enter. All I/O comments in the program in the computer's system work area will be transferred to File Memory beginning at the specified block.

#### Verification

The following procedure compares the I/O comments in the computer's system work area to ones in File Memory. An error will occur if the specified beginning block doesn't contain I/O comment (COM) data.

The verification operation will be aborted if an I/O or UM block is encountered before the last COM block (\*COM).

1, 2, 3...

1. Select "F:File Memory/Mem Card" from the Utility Menu.
2. Select "F:Computer ↔ FM" from the File Memory Menu.
3. Select "C:Comment" from the Computer ↔ FM Menu.
4. Select "V:Verify" from the Comment Menu.
5. Input the block number of the first block and press Enter. The I/O comments in the computer's system work area will be compared to the ones in File Memory beginning at the specified block.  
If a verification error occurs, the verification operation will be interrupted and the number of the block containing the error will be displayed.

#### Editing Blocks

The Edit Block operation is used to edit I/O blocks in File Memory. Data in the computer's system work area is not affected.

This operation cannot be performed while the PC is in RUN mode.

**Procedure**

The following procedure edits I/O blocks in File Memory.

1, 2, 3...

1. Select "F:File Memory/Mem Card" from the Utility Menu.
2. Select "F:Computer ↔ FM" from the File Memory Menu.
3. Select "B:Block edit" from the Computer ↔ FM Menu.

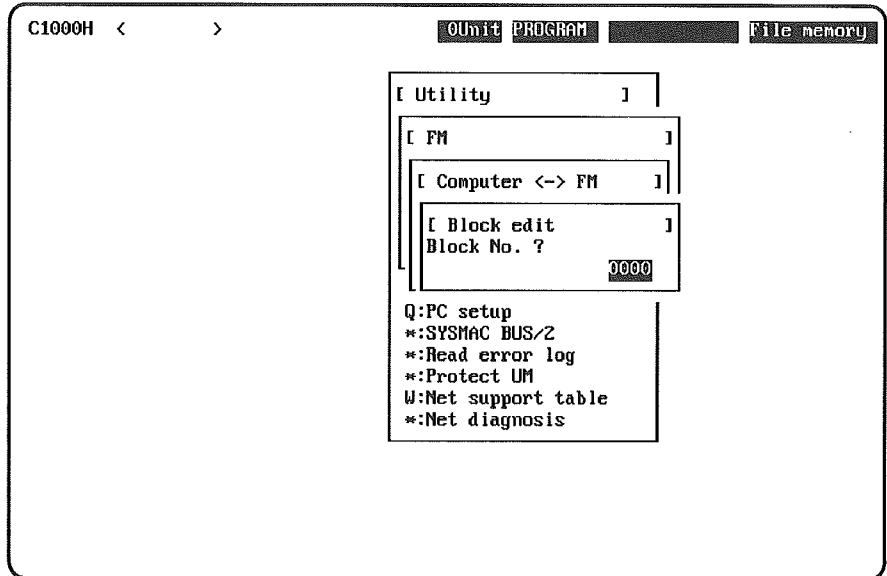

4. Input the block number of the desired I/O block and press Enter. The 128 words of the specified I/O block will be displayed.

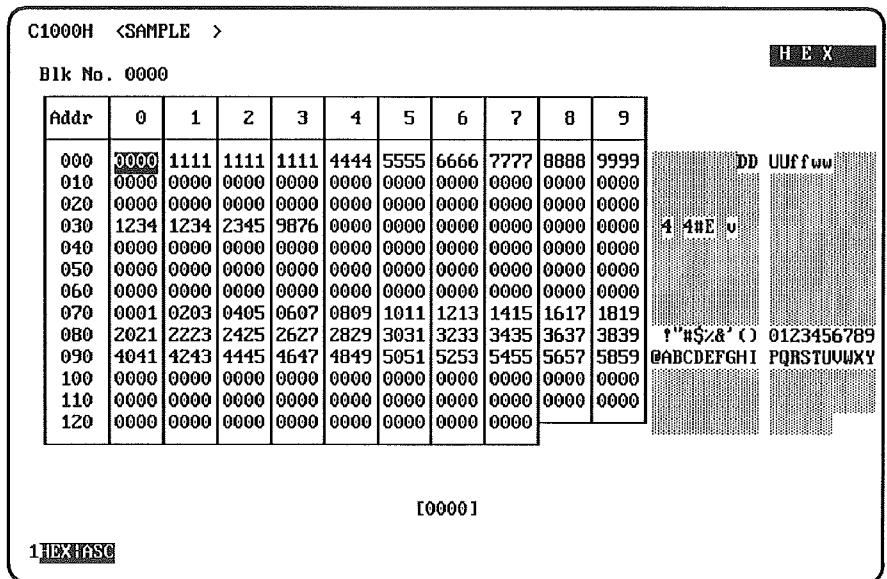

5. Words in the I/O block can be edited by moving the cursor to the desired word, inputting the new value, and pressing Enter. The content of the word will be changed in the display and in File Memory when Enter is pressed.  
Data can be input in hexadecimal or ASCII. Press F1 to switch between these formats.

6. Press Escape to return to the block number input display.

### 13-2-3 Clearing File Memory

The Clear File Memory operation is used to clear specified blocks in File Memory. If any of the specified blocks are write-protected, that block and subsequent blocks won't be cleared.

- 1, 2, 3...
1. Select "F:File Memory/Mem Card" from the Utility Menu.
  2. Select "C:Clear file memory" from the File Memory Menu.

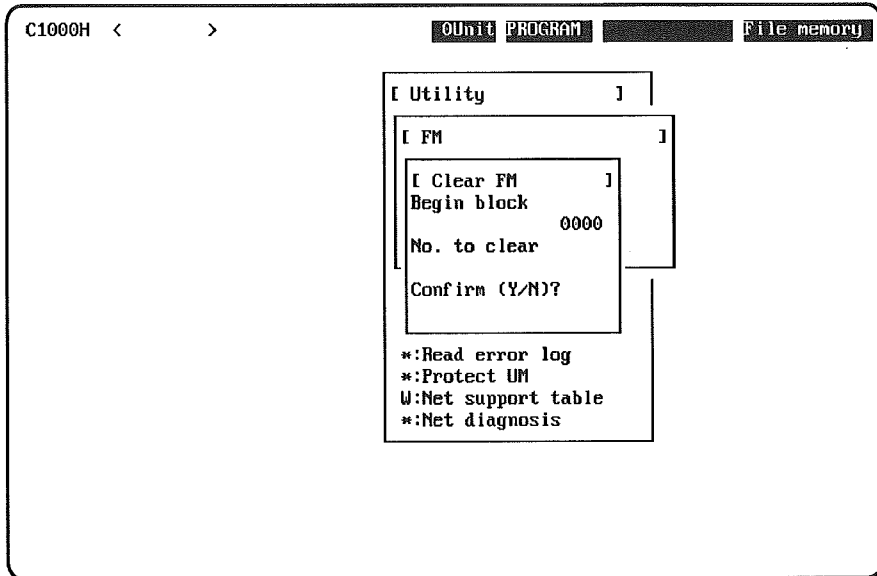

3. Input the block number of the first block to be cleared and press Enter.
4. Input the number of blocks to be cleared and press Enter.
5. A confirmation prompt will be displayed. Enter "Y" to proceed with the clear operation; enter "N" to return to the File Memory Menu.

The message "Clearing" will flash on the screen while File Memory is being cleared followed by "Finished." It takes approximately 5 minutes to clear 1000 blocks of File Memory when a peripheral bus interface is being used.

### 13-2-4 Transferring between the PC and FM

The PC ↔ FM operations are used to transfer or compare the program or data area data (IR, LR, HR, AR, TIM/CNT, and DM) between the PC and the File Memory. The following table describes the operations in the PC ↔ FM Menu.

| Operation | Function   |
|-----------|--|
| W:PC → FM | Transfers program or data area data from the PC to File Memory.    |
| R:FM → PC | Transfers program or data area data from File Memory to the PC.    |
| V:Verify  | Compares program or data area data between the PC and File Memory. |

#### PC → FM

The PC → FM operation is used to transfer data from the PC to File Memory. This operation is not possible when the PC is in RUN mode.

A "No END" error will occur if the program is being transferred but there isn't an END(01) instruction in the PC's program.

- 1, 2, 3...
1. Select "F:File Memory/Mem Card" from the Utility Menu.

2. Select "P:PC ↔ FM" from the File Memory Menu.
3. Select "W:PC → FM" from the PC ↔ FM Menu.
4. Select the data you would like to transfer. The IR area was selected in this case.

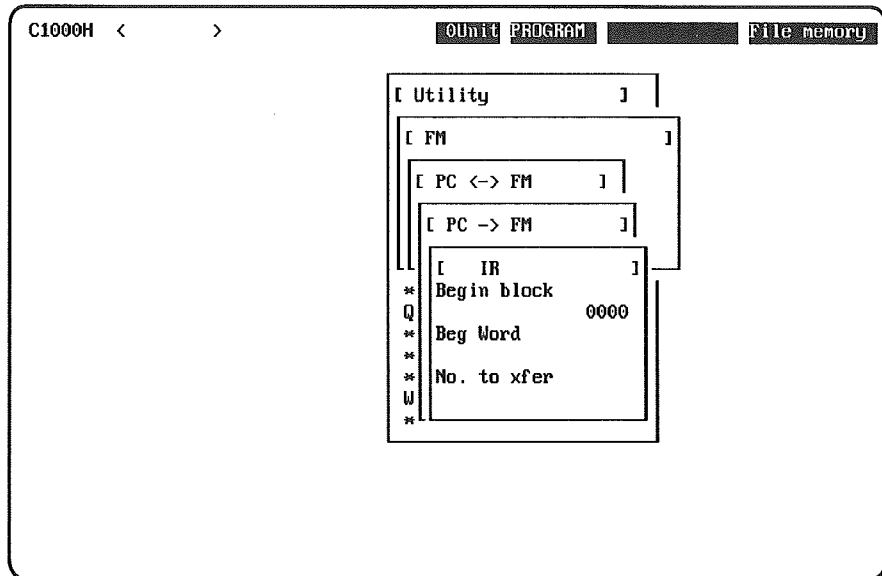

5. Input the block number of the first File Memory block to be overwritten and press Enter.  
Data transfer will begin if UM data has been specified. (The program (UM) will be transferred from program address 0 to the END(01) instruction, so steps 6. and 7. aren't necessary.)
6. Input the first address in the PC data area from which data is to be read.  
Data transfer will begin if LR, HR, or AR data have been specified. (The LR, HR, and AR areas require only one block, so step 7. isn't necessary.)
7. Input the number of 128-word blocks to be transferred and press Enter. If 99 is input, data will be transferred to the end of the specified data area.

### FM → PC

The FM → PC operation allows data to be transferred from File Memory to the PC. The PC cannot be in RUN or MONITOR mode.

An error will occur if the specified beginning block doesn't contain the specified data. If the program (UM) is being transferred, the transfer operation will be aborted if an I/O or COM block is encountered before the block containing the END(01) instruction.

#### 1, 2, 3...

1. Select "F:File Memory/Mem Card" from the Utility Menu.
2. Select "P:PC ↔ FM" from the File Memory Menu.
3. Select "R:FM → PC" from the PC ↔ FM Menu.
4. Select the data area you would like to transfer.
5. Input the block number of the first File Memory block to be transferred and press Enter.  
Data transfer will begin if UM data has been specified. (The program (UM) will be transferred from program address 0 to the END(01) instruction, so steps 6. and 7. aren't necessary.)
6. Input the first address in the PC data area to which data is to be written.  
Data transfer will begin if LR, HR, or AR data have been specified. (The LR, HR, and AR areas require only one block, so step 7. isn't necessary.)



7. Input the number of 128-word blocks to be transferred and press Enter. If 99 is input, data will be transferred to the end of the specified data area.

## Verify

The Verify operation allows data to be compared between File Memory and the PC. An error will occur if the specified beginning block doesn't contain the specified data. If the program (UM) is being compared, the comparison will be aborted if an I/O or COM block is encountered before the block containing the END(01) instruction.

- 1, 2, 3...
  1. Select "F:File Memory/Mem Card" from the Utility Menu.
  2. Select "P:PC ↔ FM" from the File Memory Menu.
  3. Select "V:Verify" from the PC ↔ FM Menu.
  4. Select the data area you would like to compare.
  5. Input the block number of the first File Memory block to be compared and press Enter.
 

Data comparison will begin if UM data has been specified. (The program (UM) will be compared from program address 0 to the END(01) instruction, so steps 6. and 7. aren't necessary.)
  6. Input the first address in the PC data area that is to be compared.
 

Data comparison will begin if LR, HR, or AR data have been specified. (The LR, HR, and AR areas require only one block, so step 7. isn't necessary.)
  7. Input the number of 128-word blocks to be compared and press Enter. If 99 is input, data will be compared to the end of the specified data area.

### 13-2-5 Transferring between a Disk and FM

The Disk ↔ FM operations are used to transfer data between a disk and the File Memory. The following table describes the operations in the Disk ↔ FM Menu.

**Note** The hard disk can also be used.

| Operation     | Function  |
|---------------|---|
| R:FM → Floppy | Copies the contents of the File Memory to disk. |
| W:Floppy → FM | Reads data from the disk to File Memory.        |

Floppy disks must be initialized using the DOS FORMAT command. Data disks initialized with the offline Create Library File Utility operation cannot be used.

#### FM → Disk

The FM → Disk operation is used to transfer the entire content of File Memory to a disk.

- 1, 2, 3...
  1. Select "F:File Memory/Mem Card" from the Utility Menu.
  2. Select "D:Floppy ↔ FM" from the File Memory Menu.

3. Select "R:FM → Floppy" from the Disk ↔ FM Menu.

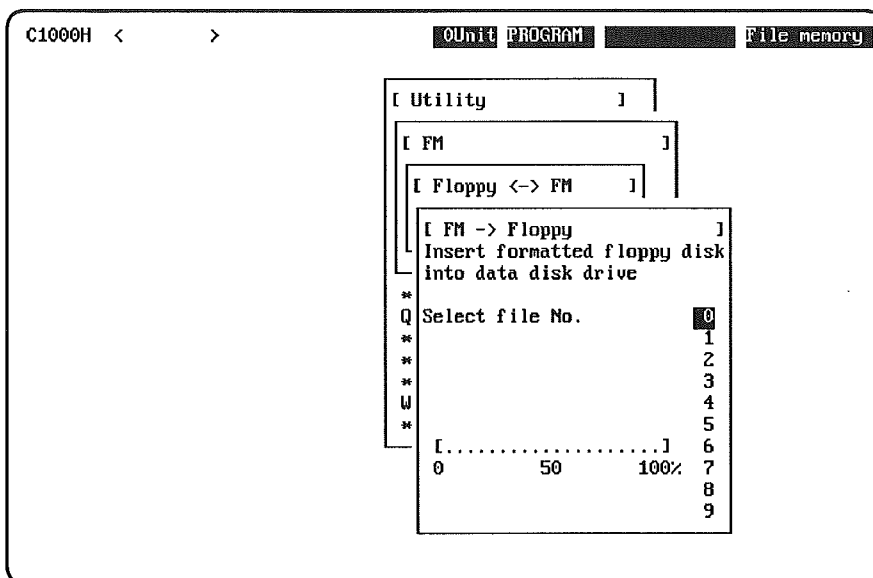

4. If using a floppy disk, insert a formatted floppy disk into the disk drive.
5. Select a file number by moving the cursor to the desired number and pressing Enter or inputting the desired number on the keyboard.

The following confirmation prompt will be displayed if a file with the specified file number already exists. Enter "Y" to overwrite the existing file; enter "N" to cancel the operation.

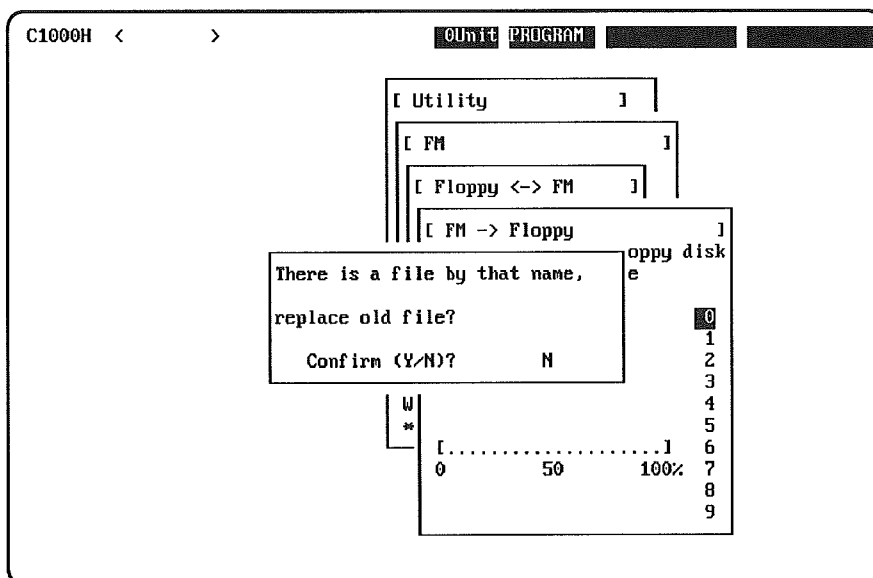

**Disk → FM**

The Disk → FM operation is used to transfer data from a disk to File Memory.

1, 2, 3...

1. Select "F:File Memory/Mem Card" from the Utility Menu.
2. Select "D:Floppy ↔ FM" from the File Memory Menu.
3. Select "W:Floppy → FM" from the Disk ↔ FM Menu.
4. If using a floppy disk, insert the floppy disk into the disk drive.

5. Select a file number by moving the cursor to the desired number and pressing Enter or inputting the desired number on the keyboard.

If a file with the specified file doesn't exist on the disk, an error message will appear and the Disk → FM menu will be displayed.

## 13-3 Time Chart Monitoring

The Time Chart Monitor operation is used to monitor the operational status of the PC in time-chart form.

With Time Chart Monitor, you can monitor up to 12 bits and 3 words simultaneously. Up-differentiation (OFF to ON) or down-differentiation (ON to OFF) of specified bits can be used to trigger data sampling.

**Note** Data traces can be performed for the C1000H, C2000H, CQM1 (CPU41 on), or C200HS to monitor bit status and word contents using a shorter sampling time than Time Chart Monitor. The differences between time chart monitoring and data tracing as shown in the following table.

| Item                             | Time chart monitoring                                 | Data tracing  |
|----------------------------------|---|---|
| PCs supported                    | All PCs supported by LSS                              | C1000H, C2000H, CQM1-CPU41-E, C200HS  |
| PC operating modes for execution | RUN, MONITOR, and PROGRAM                             | RUN and MONITOR   |
| Execution condition              | On rising or falling edge of specified bit            | On rising edge of Trace Trigger Bit (AR 1814)   |
| Sampling cycle                   | 0.5 to 25.5 s in 0.5-s increments or once every cycle | 10 ms to 2,550 ms in 10-ms increments, once every cycle, or every time TRSM is executed |
| Trace Memory                     | Not used  | Used  |

- Note**
1. Data tracing can be used for the C1000H, C2000H, CQM1-CPU41-E, C200HS to monitor status over a shorter cycle.
  2. Time chart monitoring is convenient to monitoring status when a specified bit turns ON or OFF.
  3. Time chart monitoring does not use Trace Memory and thus requires that data be sent to the SSS for each sampling. This results in a limit of 0.5 s for the cycle time to allow for communications time.
  4. Data tracing stores data in the Trace Memory of the PC and the data is later read to the SSS after the completion of the trace. The sampling time can thus be must shorter (down to 10 ms) because data does not have to be set to the SSS after each sample.

### Time Chart Monitor Menu

The following table describes the operations in the Time Chart Monitor Menu, which is displayed when "C:Time chart monitor" is selected from the Utility Menu.

| Operation  | Function   |
|------------|--|
| J:Execute  | Used to set monitoring parameters and execute the monitor operation.               |
| R:Read     | Used to display time chart monitor data from the system work area.                 |
| L:Retrieve | Used to retrieve time chart monitor data from a data disk to the system work area. |
| S:Save     | Used to save time chart monitor data from the system work area to a data disk.     |

## 13-3-1 Execute

The Execute operation is used to set parameters and execute Time Chart Monitor.

- 1, 2, 3... 1. Select "E:Execute" from the Time Chart Monitor Menu. The following display for parameter input will appear with the previous parameters.

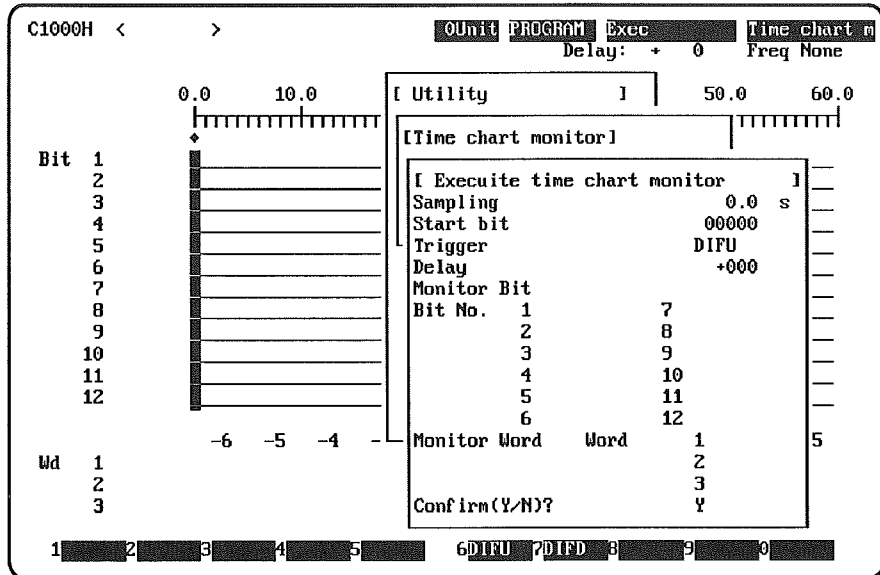

2. Press Enter to execute Time Chart Monitor with the displayed parameters and go to step 4.
- or Press N and Enter to change the parameters. The cursor will move to the input field for the sampling time.
3. Use the Up and Down Cursor Keys to move to the parameter to be changed and input the desired parameter.  
The Home Key can be used to set the current input field to 0. If the field is already 0, pressing the Home Key will delete the input completely, except for the sampling time, trigger, and delay, which cannot be deleted.

The parameters are described in the following table.

| Parameter    | Function   | Keys                 | Input range                               |
|--------------|--|----------------------|---|
| Sampling     | The frequency at which data will be sampled and displayed on the SSS. The sampling frequency will be approximately 0.3 s (the cycle time between the SSS and PC) even if 0.0 s is set.   | 0 to 9               | 0 or 0.5 to 25.5 s in increments of 0.5 s |
| Start bit    | The bit that will determine the starting point (i.e., trigger) for monitoring. The transition used for the trigger condition is set in the TRIGGER parameter. If a start bit is not set, an error message will appear when the monitor operation is started. | Area keys and 0 to 9 | Any bit but the Always ON/ OFF Flags      |
| Trigger      | Specifies whether an OFF-to-ON transition or an ON-to-OFF transition in the START BIT is to trigger the monitor operation.   | F6 and F7            | —   |
| Delay        | Specifies how much the actual start of the monitor operation is to be offset from the trigger. The delay is input as the number of samples and can be negative (before the trigger) or positive (after the trigger).   | -, +, and 0 to 9     | -249 to +250                              |
| Monitor Bit  | The bits to be monitored. Up to 12 bits can be monitored and their ON-OFF transitions will be display in time-chart form.  | Area keys and 0 to 9 | Any bit                                   |
| Monitor Word | The words to be monitored. Up to three words (including data area words and timer/counter PV) can be monitored numerically.  | Area keys and 0 to 9 | Any word                                  |

The number of samples required to complete monitoring depends on the number of words being monitored, as shown in the following table.

| Number of words | Number of samples |
|-----------------|-------------------|
| None            | 1,000             |
| 1               | 500               |
| 2               | 333               |
| 3               | 250               |

- Input Y and Enter at "Confirm (Y/N)?" when all of the parameters have been set as required. The time chart display will start operation according to the start bit, trigger, and delay settings.

The monitoring operation will end when Escape is pressed or the data area allocated to time chart monitoring in the system work area is full. The resulting data will be displayed as shown below.

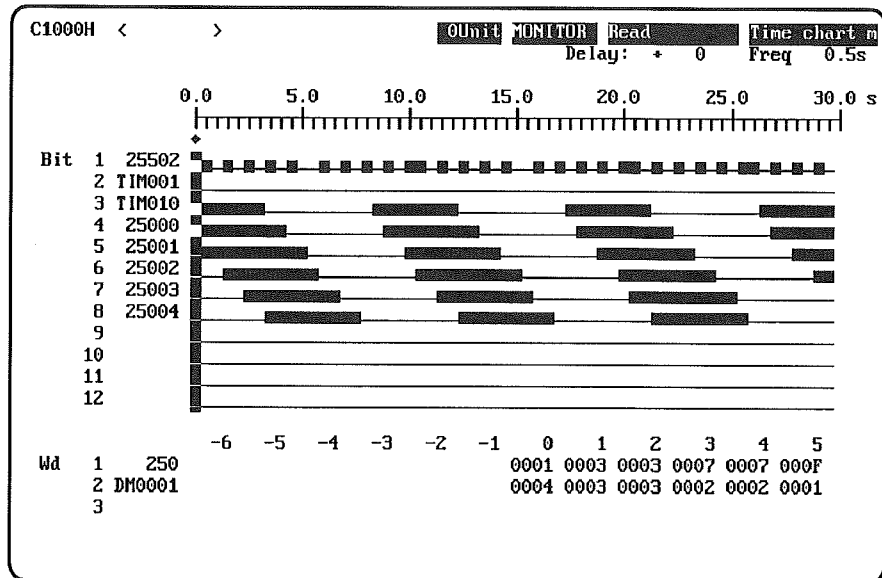

**Note** If the sampling frequency is set to 0, the number of samples will be displayed.

The Left and Right Cursor Keys can be used to scroll horizontally through the display.

Twelve samples of word data will be displayed around zero position at the bottom of the screen.

Press the Escape or End Key to return to the menu.

### 13-3-2 Read

The Read operation is used to display time chart data stored in the system work area. This operation cannot be executed unless time chart monitor data exists in the system work area.

- 1, 2, 3...
1. Select "R:Read" from the Time Chart Monitor Menu. The display for parameter input will appear with the previous parameters.
  2. Press Enter to display the time chart monitor data.
- The display that appears is the same as the one displayed after execution. Refer to 13-3-1 *Execute* for details.

### 13-3-3 Retrieve

The Retrieve operation is used to retrieve time chart data from a disk.

- 1, 2, 3...
1. Select "L:Retrieve" from the Time Chart Monitor Menu.
  2. The filename can be input directly or selected from a list of files on the disk. Press the End Key to display the list of files.
- The file will be copied to the computer's system work area and displayed.
- The display that appears is the same as the one displayed after execution. Refer to 13-3-1 *Execute* for details.

### 13-3-4 Save

The Save operation is used to save time chart data to a disk.

- 1, 2, 3... 1. Select "S:Save" from the Time Chart Monitor Menu.
2. The filename can be input directly or selected from a list of files on the disk. Press the End Key to display the list of files.  
A confirmation prompt will be displayed if the specified file already exists. Enter "Y" to overwrite the file, "N" to cancel.

## 13-4 Instruction Traces

The Instruction Trace operation is used to monitor program execution status in mnemonic form. The operation is supported by the C1000H and C2000H only.

Execution is possible in PROGRAM mode only, but reading, retrieving, and saving are possible in any PC operating mode.

The program in the computer must be identical to the one in the PC.

### Instruction Trace Menu

The following table describes the operations in the Instruction Trace Menu, which is displayed when "S:Instruction trace" is selected from the Utility Menu.

| Operation  | Function  |
|------------|---|
| J:Execute  | Used to set trace parameters and to execute the trace operation.                  |
| R:Read     | Used to display instruction trace data from the system work area.                 |
| R:Retrieve | Used to retrieve instruction trace data from a data disk to the system work area. |
| S:Save     | Used to save instruction trace data from the system work area to a data disk.     |

### 13-4-1 Execute

The Execute operation is used to set parameters and execute instruction traces.

- 1, 2, 3... 1. Select "E:Execute" from the Instruction Trace Menu. The following display for parameter input will appear with the previous parameters.

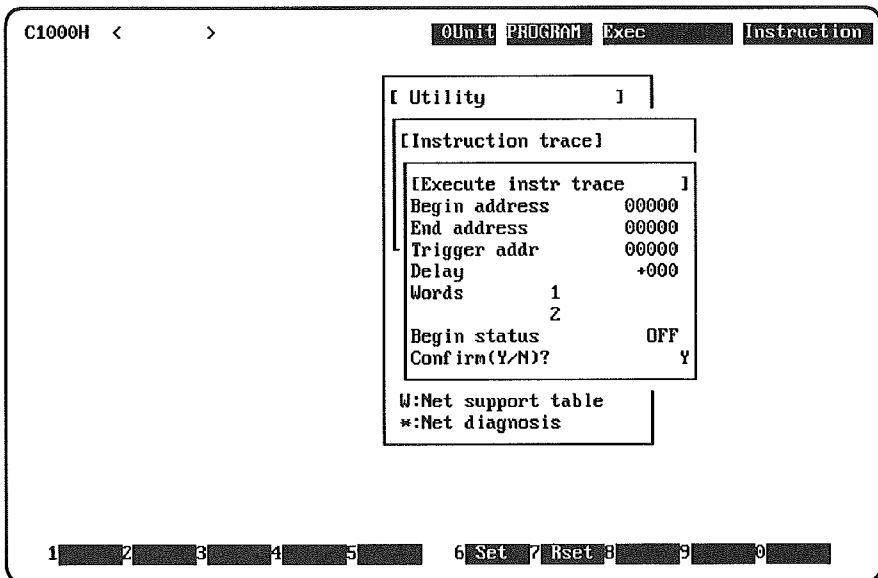

2. Press Enter to execute the trace with the displayed parameters and go to step 4.
- or Press N and Enter to change the parameters. The cursor will move to the input field for the beginning address.

3. Use the Up and Down Cursor Keys to move to the parameter to be changed and input the desired parameter.

The parameters are described in the following table.

| Parameter     | Function   | Keys                 | Input range  |
|---------------|--|----------------------|--|
| Begin address | The starting point for instruction tracing.  | 0 to 9               | From 00000 to one less than last address in program<br>00000 ≤ begin address                                       |
| End address   | The end point for instruction tracing. All instructions up to, but not including, this instruction will be traced.   | 0 to 9               | From one larger than beginning address to last address in program<br>Begin address < end address                   |
| Trigger addr  | The address that determined the starting point for displaying instruction trace results.   | 0 to 9               | Any address between beginning and end addresses  |
| Delay         | An offset for the trigger address, i.e., specifies where displaying instruction trace results will start in reference to the trigger address.<br><br>If the delay is set to positive 1 or greater, the trigger step will not be displayed. | -, +, and 0 to 9     | -249 to +250   |
| Words 1 and 2 | Words whose contents are to be displayed during the instruction trace. Up to two words can be specified.   | Area keys and 0 to 9 | IR 000 to 225<br>LR 00 to 63<br>HR 00 to 99<br>AR 00 to 27<br>DM 0000 to 6655*<br>TIM 000 to 511<br>CNT 000 to 511 |
| Begin status  | The initial status of the execution condition.   | F6                   | ON   |
|               |  | F7                   | OFF  |

**Note** \*DM addresses are from DM 0000 to DM 4095 for the C1000H.

The number of samples required to complete tracing depends on the number of words being traced, as shown in the following table.

| Number of words | Number of samples |
|-----------------|-------------------|
| None            | 1,000             |
| 1               | 500               |
| 2               | 333               |



- Input Y and Enter at CONFIRM when all of the parameters have been set as required. The instruction trace will begin and the instruction currently being executed will be displayed.

```

C1000H < >          OUnit PROGRAM Exec Instruction
                          Loop =0007

  ST Addr  Instruction      Data      ST Addr  Instruction      Data
  0 00022 END (01)
  0 00022 END (01)
  0 00022 END (01)
  0 00022 END (01)
  0 00022 END (01)
  0 00022 END (01)
  0 00022 END (01)

                          Exec'g
    
```

The number of loops displayed in the top right corner is the number of times the program has been executed between the beginning and end instructions.

The tracing operation will end when the data area allocated for instruction tracing on the system work area is full or until the Escape Key is pressed. The resulting data will be written to the system work area and displayed as in the following illustration.

Interlocked  
Monitor word 2  
Monitor word 1

Status of execution condition  
Cursor

Delay (between trigger step and cursor)

No. of loops

Trigger step

Jumped

```

C1000H < >          OUnit PROGRAM Read Instruction
                          Delay: +005 Loop =0011

  DM0001  005  Status  Addr  Instruction      Comment  I/O comment
  1234  0000  0  ->  00005 LD          00003 LSW 2
  1234  0000  0  00006 IL (02)
  1234  0000  IL 0  00007 LD NOT   00004 LSW 11
  1234  0000  IL 1  00008 OR          00501 MC 5-2
  1234  0000  IL 1  00009 AND NOT  00005 STOP
  1234  0000  IL 1  00010 OUT        00501 MC 5-2
  1234  0000  IL 1  00011 ILC (03)
  1234  0000  1  00012 LD          TIM 000 TIM 2s
  1234  0000  0  00013 AND NOT   00501 MC 5-2
  1234  0000  0  00014 OUT        00502 MC 5-2
  1234  0000  0  00015 LD          00006
  1234  0000  0  00016 JMP (04)   00
  1234  0000  JMP 0  00017 LD NOT   00007
  1234  0000  JMP 1  00018 MOV (21)
                          #1234
                          DM 0001
  1234  0000  JMP 1  00019 JME (05) 00
  1234  0000  1  00020 LD          00000 start
                          Continued
    
```

- Use the Up and Down Cursor Keys and the PageUp and PageDown Keys to scroll through the results.

The delay display at the top right of the screen will indicate the offset between the instruction at the cursor position and the trigger instruction.

6. Press the Escape or End Key to return to the Instruction Trace Menu.

The first and last addresses read can be determined as shown in the following table.

| Condition  | Delay    | First address           | Last address                               |
|--|----------|-------------------------|--|
| Trigger step executed                                    | Positive | Trigger address + delay | Last instruction stored in trace memory.   |
|  | Zero     | Trigger address         |  |
|  | Negative | Trigger address – delay |  |
| Trace canceled with Escape before trigger step execution | Any      | Beginning address       | Instruction where operation was cancelled. |

### 13-4-2 Read

The Read operation is used to display instruction trace data stored in the system work area. This operation cannot be executed unless instruction trace data exists in the system work area.

- 1, 2, 3...
1. Select "R:Read" from the Instruction Trace Menu. The display for parameter input will appear with the previous parameters.
  2. Press Enter to display the instruction trace data.  
The display that appears is the same as the one displayed after execution. Refer to 13-4-1 *Execute* for details.

### 13-4-3 Retrieve

The Retrieve operation is used to retrieve instruction trace data from a disk.

- 1, 2, 3...
1. Select "L:Retrieve" from the Instruction Trace Menu.
  2. The filename can be input directly or selected from a list of files on the disk. Press the End Key to display the list of files.  
The file will be copied to the computer's system work area and displayed.  
The display that appears is the same as the one displayed after execution. Refer to 13-4-1 *Execute* for details.

### 13-4-4 Save

The Save operation is used to save instruction trace data to a disk.

- 1, 2, 3...
1. Select "S:Save" from the Instruction Trace Menu.
  2. The filename can be input directly or selected from a list of files on the disk. Press the End Key to display the list of files.  
A confirmation prompt will be displayed if the specified file already exists. Enter "Y" to overwrite the file, "N" to cancel.

## 13-5 Data Traces

The Data Trace operation is used to sample the status of specified bits or the content of specified words and store the result in the PC's trace memory.

Data traces cannot be executed with the PC in PROGRAM mode, but read, retrieve, and save commands can be used when the PC is in any operating mode.

With data traces, you can monitor up to 12 bits and 3 words simultaneously.

Data traces are supported for the C1000H, C2000H, CQM1 (except CPU11 and CPU21), and C200HS only.

Data traces is similar to Time Chart Monitor, but differs in the following ways.

- 1, 2, 3... 1. Time Chart Monitor writes monitor results directly to the system work disk when samples are taken, whereas data traces write monitor results to the PC's trace memory and then transfers the data to the system work disk after execution has been completed. This enables a shorter sampling time for data traces (down to 0.1 s) because it is not affected by communications delays.
2. Sampling for data traces can be activated from within the user program by using the TRSM and END instructions.
3. Time Chart Monitor is activated by the start bit and trigger condition, whereas data traces are activated by the Trace Trigger Bit, AR 1814, going ON (although both can be affected by a delay setting). AR 1814 can be turned ON from the program or from the SSS. The operation of AR 1814 and the rest of the data trace operation is shown in the following diagram.
  - a) Sampling begins when AR 1815 is turned ON and AR 1813 goes ON.
  - b) Data is recorded when AR 1814 goes ON, plus or minus the delay.
  - c) Sampling ends when the trace memory is full and the Trace Completed Flag, AR 1812, goes ON.

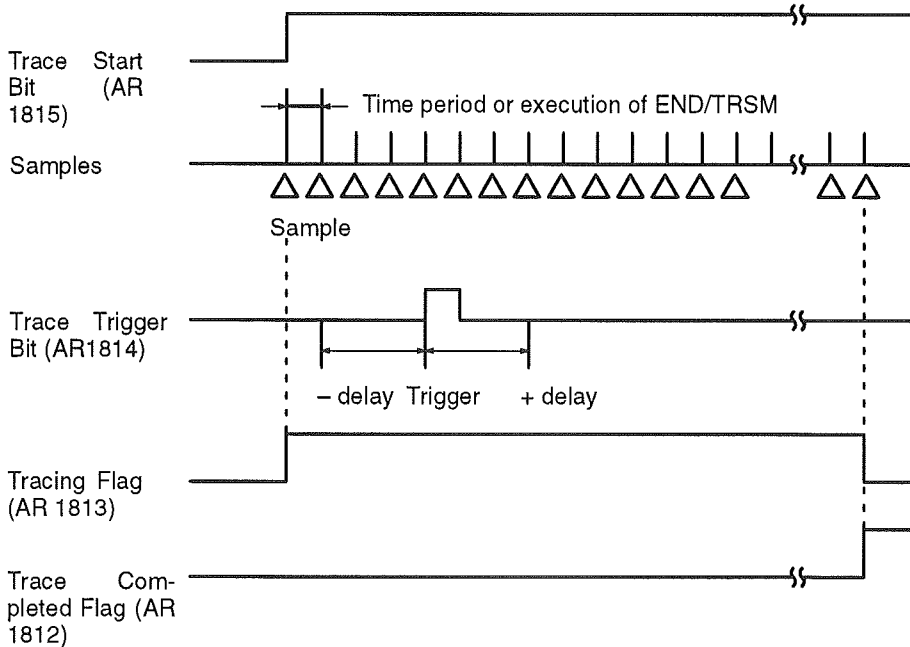

**Data Trace Menu** The following table describes the operations in the Data Trace Menu, which is displayed when "T:Data trace" is selected from the Utility Menu.

| Command    | Function   |
|------------|--|
| J:Execute  | Used to set monitoring parameters and to execute the monitor operation.    |
| R:Read     | Used to read data trace data from the system work disk to the display.     |
| L:Retrieve | Used to retrieve data trace data from a data disk to the system work disk. |
| S:Save     | Used to save data trace data from the system work area to a data disk.     |

### 13-5-1 Execute

The Execute operation is used to set parameters and execute data traces.

- 1, 2, 3... 1. Select "E:Execute" from the Data Trace Menu. The following display for parameter input will appear with the previous parameters.

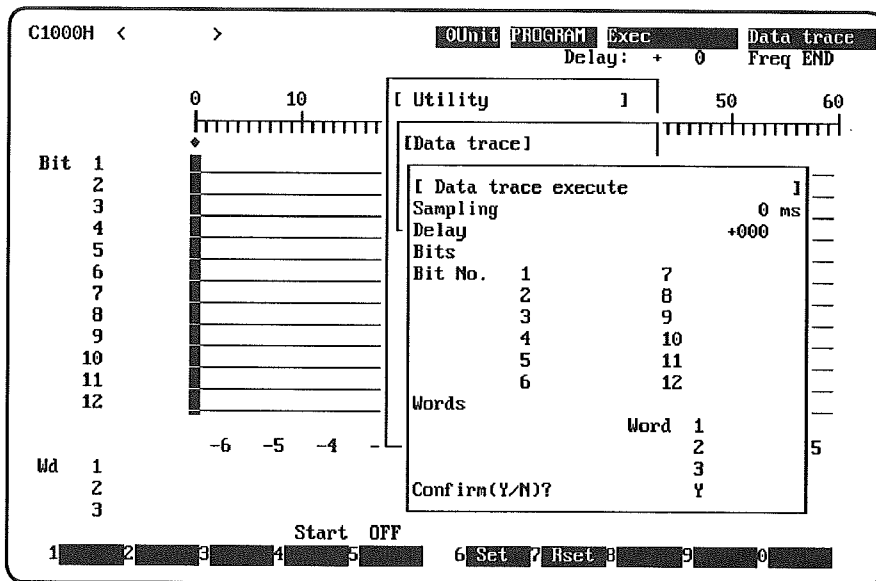

2. If the Trace Start Flag is ON, press the F7 Key to turn it OFF.
3. Press Enter to execute the data trace with the displayed parameters and go to step 5.
- or Press N and Enter to change the parameters. The cursor will move to the input field for the sampling time.
4. Use the Up and Down Cursor Keys to move to the parameter to be changed and input the desired parameter.

The Home Key can be used to set the current input field to 0. If the field is already 0, pressing the Home Key will delete the input completely, except for the sampling time and delay, which cannot be deleted.

The parameters are described in the following table.

| Parameter | Function   | Keys                  | Input range    |
|-----------|--|-----------------------|----------------|
| Sampling  | The frequency at which data will be sampled and displayed on the SSS. Samples will be taken at the END or TRSM instruction if the sampling frequency is set to 0.  | 0 to 9                | 10 to 2,550 ms |
| Delay     | Specifies how much the actual start of the monitor operation is to be offset from the Trace Trigger Bit (AR 1814). The delay is input as the number of samples and can be negative (before the trigger) or positive (after the trigger). | -, +, and 0 to 9      | -249 to +250   |
| Bits      | The bits to be monitored. Up to 12 bits can be monitored and their ON-OFF transitions will be display in time-chart form.  | Area keys* and 0 to 9 | Any bit        |
| Words     | The words to be monitored. Up to three words (including data area words and timer/counter PV) can be monitored numerically.  | Area keys* and 0 to 9 | Any word       |

**Note** \*Ctrl+ the function keys are used to designate data areas.

The number of words being monitored affects the number of samples required to complete monitoring as shown in the following table.

| Number of words | Number of samples |
|-----------------|-------------------|
| None            | 1,000             |
| 1               | 500               |
| 2               | 333               |
| 3               | 250               |

5. Input Y and Enter at "Confirm(Y/N)?" when all of the parameters have been set as required. AR 1815 will go on automatically and sampling will start.

**Note** Never control the status of AR 1815 from the program as doing so may prevent data tracing.

6. Turn ON the Trace Trigger Bit (AR 1814) to start recording data. This can be done from the user program or, if not programmed, by pressing F6 after starting data trace sampling.

Sampling will take place at one of three types of event, as shown in the following table.

| Event    | Setting  | Sampled data                             |
|----------|--|--|
| Sampling | Samples will be taken at a constant time interval. Do not use TRSM(45) in the program when using the sampling frequency for sampling.                                      | Periodic memory status                   |
| TRSM(45) | If the sampling frequency is set to 0, samples will be taken when TRSM(45) is executed in the program. More than one TRSM(45) instruction can be used in the same program. | Memory status when TRSM(45) is executed. |
| END(01)  | If the sampling frequency is set to 0 and TRSM(45) is not in the program, samples will be taken when END(01) is executed.  | Memory status when END(01) is executed.  |

**Note** Refer to your PC's operation manual for details on TRSM(45).

The monitor operation will end when the trace memory is full or the Escape Key is pressed. The resulting data will be written to the system work area and will be displayed as in the following illustration.

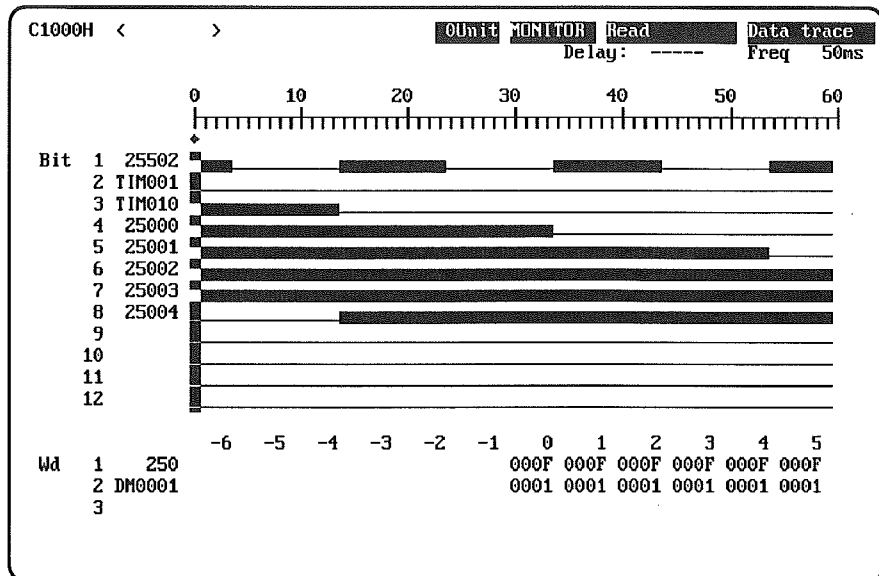

The Left and Right Cursor Keys can be used to scroll horizontally through the display.

Twelve samples of word data will be displayed around the position indicated by the cursor, although 0 and the cursor will not necessarily line up on the screen.

Press the Escape or End Key to return to the menu.

### 13-5-2 Read

The Read operation is used to display data trace data stored in the system work area. This operation cannot be executed unless data trace data exists in the system work area.

- 1, 2, 3...
1. Select "R:Read" from the Data Trace Menu. The display for parameter input will appear with the previous parameters.
  2. Press Enter to display the instruction trace data.  
The display that appears is the same as the one displayed after execution. Refer to 13-5-1 *Execute* for details.

### 13-5-3 Retrieve

The Retrieve operation is used to retrieve data trace data from a disk.

- 1, 2, 3...
1. Select "L:Retrieve" from the Data Trace Menu.
  2. The filename can be input directly or selected from a list of files on the disk. Press the End Key to display the list of files.  
The file will be copied to the computer's system work area and displayed.  
The display that appears is the same as the one displayed after execution. Refer to 13-5-1 *Execute* for details.

### 13-5-4 Save

The Save operation is used to save data trace data to a disk.

1, 2, 3...

1. Select "S:Save" from the Data Trace Menu.
2. The filename can be input directly or selected from a list of files on the disk. Press the End Key to display the list of files.  
A confirmation prompt will be displayed if the specified file already exists. Enter "Y" to overwrite the file, "N" to cancel.

## 13-6 Debugging

The Debug operation is used to execute one instruction at a time or a specified block of instruction while displaying bit status and word contents.

The Debug operation is supported only for the C1000H and C2000H.

The Debug operation is possible only when the PC is in PROGRAM mode.

To execute the Debug operation, select "D:Debug" from the Utility Menu. The program will be displayed beginning with address 00000 and an input field for the beginning address will appear at the bottom of the screen.

| C1000H < >          |             |                   | 0Unit   | PROGRAM     | Step exec         | Debug exec |
|---------------------|-------------|-------------------|---|-------------|-------------------|------------|
| Addr                | Instruction | Comment           | Addr  | Instruction | Comment           |            |
| 00000               | LD          | 25313 normally ON | 00015   | LD          | TIM 010 5s        |            |
| 00001               | AND NOT     | 00500 reset       | 00016   | OUT         | 00201 5/5 flicker |            |
| 00002               | TIM         | 001               | 00017   | LD          | 00200 30s/3s      |            |
|                     |             | #0330             | 00018   | AND         | 00201 5/5 flicker |            |
| 00003               | LD          | TIM 001 33s       | 00019   | LD          | 25502 CPB 1s      |            |
| 00004               | OUT         | 00500 reset       | 00020   | LD NOT      | 00200 30s/3s      |            |
| 00005               | LD          | 25313 normally ON | 00021   | SFT (10)    | 250               |            |
| 00006               | CMP (20)    |                   |   |             | 250               |            |
|                     |             | TIM 001           | 00022   | LD          | 25502 CPB 1s      |            |
|                     |             | #0031             | 00023   | @INC (3B)   | DM 0001           |            |
| 00007               | AND NOT     | 25507 compare     |   |             |                   |            |
| 00008               | AND NOT     | TIM 001 33s       |   |             |                   |            |
| 00009               | OUT         | 00200 30s/3s      |   |             |                   |            |
| 00010               | LD          | 00200 30s/3s      |   |             |                   |            |
| 00011               | AND NOT     | TIM 011 5s        |   |             |                   |            |
| 00012               | TIM         | 010               |   |             |                   |            |
|                     |             | #0050             |   |             |                   |            |
| 00013               | LD          | TIM 010 5s        |   |             |                   |            |
| 00014               | TIM         | 011               |   |             |                   |            |
|                     |             | #0050             |   |             |                   |            |
| Enter begin address |             |                   | 00000   |             |                   |            |
|                     |             |                   | 1 [ ] 2 [ ] 3 [ ] 4 LD 5 OR 6 AND 7 OUT 8 TR 9 NOT 0(RUN) |             |                   |            |

### Beginning Address

The beginning address for execution can be designated by moving the cursor, by inputting the program address, by searching for an instruction, or by searching for an operand. The following keys can be used.

| Keys             | Use  |
|------------------|--|
| 0 to 9           | Inputting bit addresses, program addresses, or function codes. |
| F4 to F10        | Designating instructions.                                      |
| Data area keys   | Designating data areas.  |
| PageUp, PageDown | Scrolling the display.   |
| Cursor keys      | Moving the cursor.   |
| Ctrl+ Home       | Clearing an input field.                                       |
| Home             | Clearing addresses or function codes.                          |

### Cursor Designation

Use the PageUp, PageDown, and Cursor Keys to move the cursor to the beginning address.

**Address Designation**

Numerically input the beginning address in the program.

**Instruction Searches**

Use the F4 to F10, 0 to 9, and data area keys to specify the desired instruction and press Enter. The Enter Key can be pressed as many times possible to locate the desired instruction. Press Escape when the desired instruction is found. The Backspace Key can be used to restart the search from the beginning of the program.

**Bit Searches**

Press the CTRL + 9 Keys, and then use the 0 to 9 and data area keys to specify the desired bit operand and press Enter. The Enter Key can be pressed as many times possible to locate the desired operand. Press Escape when the desired operand is found. The Backspace Key can be used to restart the search from the beginning of the program.

**Instruction Execution**

Use the following procedure to execute instructions on at a time.

1, 2, 3...

1. Select "D:Debug" from the Utility Menu.
2. Specify the desired beginning address and press Enter to activate the Debug operation.

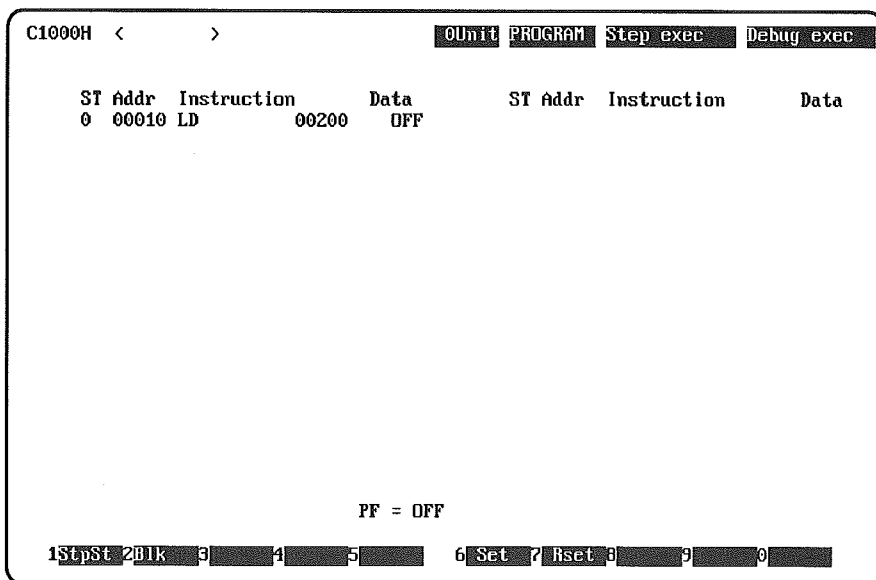

3. One step of the program will be executed each time that Enter is pressed. The display will show the program address, instruction, PF status, and bit or word status. The execution condition (PF) can be changed by pressing F6 (SET) or F7 (RESET).
4. Continue pressing Enter to execute the program until the END instruction or press F1 to input a new beginning address.

**Block Execution** Once instruction execution has begun, you can press the F2 Key to execute an entire block of instructions at once.

1, 2, 3...

1. Select "D:Debug" from the Utility Menu.
2. Specify the desired beginning address and press Enter to activate the Debug operation. The current instruction will be executed and the resulting status will be displayed. You can continue inputting Enter at this time to execute instructions one at a time.
3. Press F2 and input the end address in the same manner as you input the beginning address. The program will be executed through the end address.



The status and data for the instruction at the end address will be displayed when the block has been executed, but the instruction at addresses between the beginning and end address will not be displayed.

4. You can continue using the F1 Key to input new beginning addresses or the F2 Key to input an end address (using the current address as the beginning address). Press the Escape Key to end execution.

## 13-7 Reading and Setting the Clock

The Read/Set Clock operation is used to read and set the internal clock in the PC. The clock cannot be set with the PC in RUN mode; it can be read in any PC mode. The clock can be read or set only for the CQM1 or C200HS and only when a clock-equipped memory cassette has been mounted to the PC.

Use the following procedure to read and set the clock in the PC.

- 1, 2, 3... 1. Select "K:Display/Set Clock" from the Utility Menu. The following display will appear. (You can return to the Utility Menu at this point by pressing Escape.)

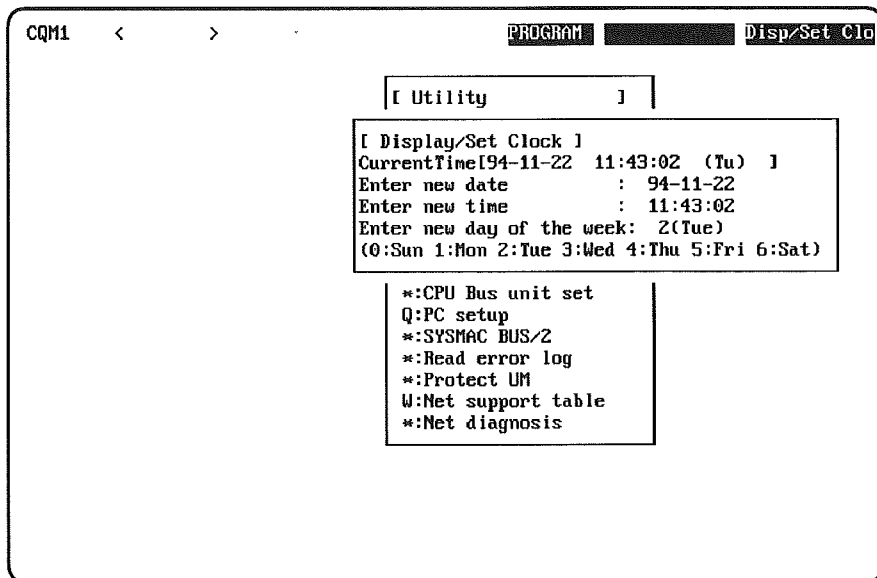

2. Input the date in the order year, month, day using the cursor and numeric keys.
3. Input the time in the order hour, minutes, and seconds using the cursor and numeric keys.
4. Input the day of the week by input a number between 0 and 6.
5. Press Enter. The new date and time will be set in the PC and the Utility Menu will return.

## 13-8 Transferring Expansion Instructions

Transfers the expansion instructions from the CQM1, C200HS, or C200HX/C200HG/C200HE to the computer. (Refer to 5-12 *Expansion Instructions* for details.)

## 13-9 PC Setup

Sets or transfers the PC Setup parameters. (Refer to 5-13 *PC Setup* for details.)



# Part 4

# Networks

This part of the manual covers procedures needed to set up and operate data links in SYSMAC NET and SYSMAC LINK networks.

Refer to the *SYSMAC NET Link System Manual* or *SYSMAC LINK System Manual* for more details on data link tables, data link areas, or other information such as network configurations.



## **SYSMAC NET Data Link Communications**

This section provides information on setting up, controlling, and maintaining data links in a SYSMAC NET network as well as creating a routing table in the SSS in order to communicate with other PCs through the SYSMAC NET network.

|        |   |     |
|--------|---|-----|
| 14-1   | SYSMAC NET Data Link Communications .....   | 342 |
| 14-2   | Overall Procedure .....                     | 342 |
| 14-3   | SYSMAC NET Data Link Table Menu .....       | 343 |
| 14-3-1 | Setting the Number of Nodes .....           | 344 |
| 14-3-2 | Editing Data Link Tables .....              | 344 |
| 14-3-3 | Checking Data Link Tables .....             | 346 |
| 14-3-4 | Clearing Data Link Tables .....             | 347 |
| 14-3-5 | Retrieving Data Link Tables .....           | 348 |
| 14-3-6 | Saving Data Link Tables .....               | 348 |
| 14-4   | Transferring Data Link Tables .....         | 349 |
| 14-4-1 | Transferring to the Computer .....          | 350 |
| 14-4-2 | Transferring to the PC .....                | 350 |
| 14-4-3 | Comparing Data Link Tables .....            | 350 |
| 14-5   | Creating and Modifying Routing Tables ..... | 351 |

## 14-1 SYSMAC NET Data Link Communications

This section provides an overview of the data link function in SYSMAC NET Link Systems. Refer to the SYSMAC NET Link System Manual for details on data link tables, data link areas, or information such as network configuration.

Data links can be established between PCs and computers on a SYSMAC NET or SYSMAC LINK network to exchange data automatically. To achieve automatic data exchange, data link tables are established at each node to specify the words that are to be exchanged. The results is that the nodes share data in what are called common data areas, i.e., the data areas linked at each of the nodes is exactly the same as the corresponding areas at the other nodes. Each node thus has certain words to which it writes data called write words and words written by other nodes called read words (i.e., the local node can only read words written by other nodes).

**Data Link Tables** The data link tables contain parameters necessary to automatically transfer data between the nodes in the data link. These data link tables must be established before any data link communications are possible.

There are two ways to establish data link tables: automatically and manually. The operations described in this manual to create and edit data link tables are not necessary if the SYSMAC NET System is set up to automatically generate data link tables from the LR Areas of the PCs.

Manually establishing data link tables involves inputting data link tables on the SSS or host computers and transferring them to the PCs and other participating nodes. The operations required to input and transfer the data link tables using the SSS are described in the rest of this section.

## 14-2 Overall Procedure

The following procedure is used to input and transfer data link tables. Be sure to read the rest of this section before attempting to carry out this procedure. Only the last of these steps is performed online.

- 1, 2, 3...**
1. Set the number of nodes in the data link.
  2. Input the data link table.
  3. Check the data link table.
  4. Switch to online operation.
  5. Transfer the data link tables to the PCs.

## 14-3 SYSMAC NET Data Link Table Menu

The offline SYSMAC NET Data Link Table Menu can be accessed by selecting "W"Net support table" from the offline Utility Menu and then selecting "N:Data link (SYSMAC NET)." The following menu will appear. This menu can also be accessed by pressing the End Key during data link table operations.

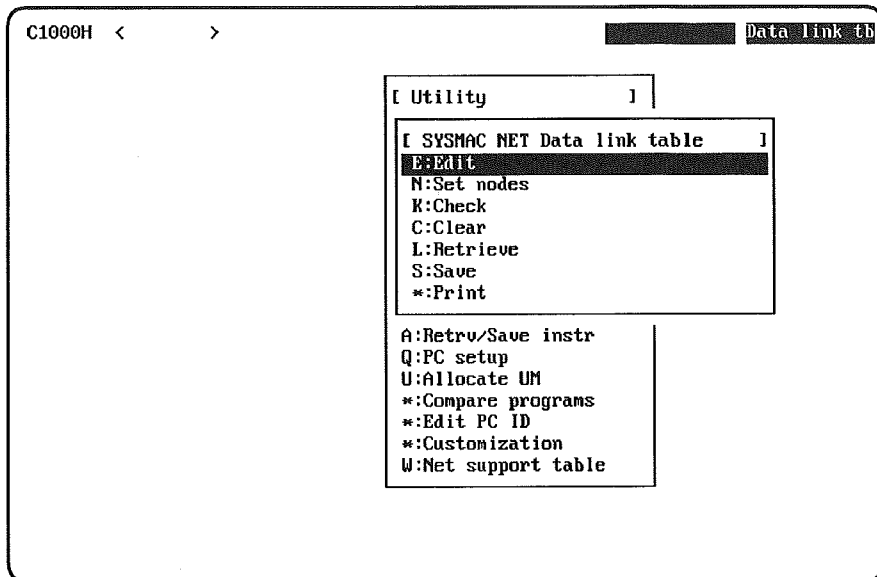

The following table describes the operations found in the SYSMAC NET Data Link Table Menu.

| Operation   | Function  |
|-------------|---|
| E:Edit      | Used to input and correct data link tables.                                 |
| N:Set nodes | Used to set the number of nodes to participate in a data link.              |
| K:Check     | Used to check the data link tables for setting errors.                      |
| C:Clear     | Used to clear the contents of the data link tables being display on-screen. |
| L:Retrieve  | Used to read a data link table from a disk to the screen.                   |
| S:Save      | Used to save the data link table displayed on-screen to a disk.             |

### 14-3-1 Setting the Number of Nodes

The Set Nodes operation sets the number of nodes in the data link table. If the number of nodes is increased, data link tables will be added for the new nodes. If the number of nodes is decreased, data link tables will be deleted starting from the ones with the highest node numbers. The number of nodes can also be set when using the Clear operation.

The procedure is as follows:

- 1, 2, 3... 1. Select "N:Set nodes" from the SYSMAC NET Data Link Table Menu.

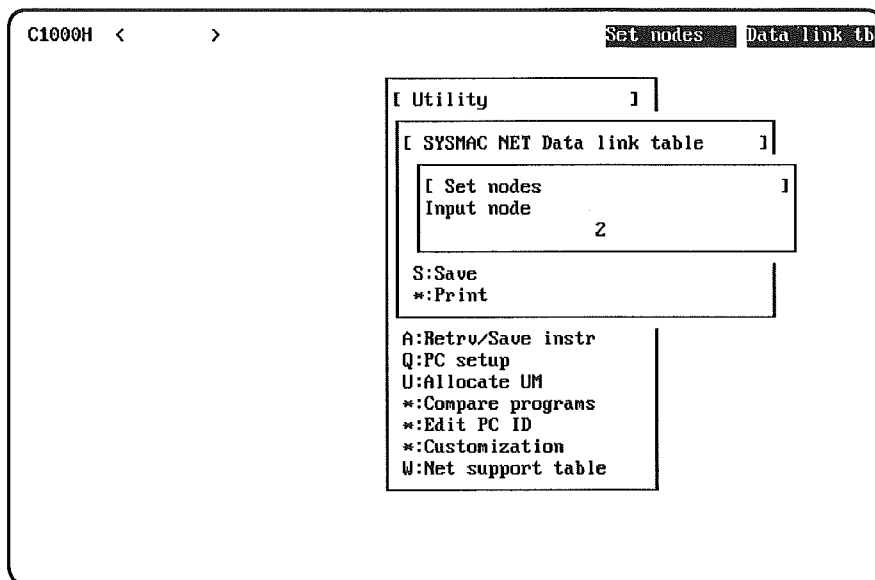

2. Input the number of nodes. The range of node numbers is from 2 to 32. If the input number of nodes is greater than the current number, the difference is added to the current number. If the input number of nodes is less than the current number, the extra nodes are deleted starting from the one having the highest node number.
3. Press Enter. A data link table with the specified number of nodes will be displayed.

### 14-3-2 Editing Data Link Tables

The Edit operation can be used to input and correct data link tables. The information in the table can also be sorted.

Set the number of nodes to be in the data link before editing a data link table.

The following parameters appear in a data link table.

| Parameter                                   | Setting  |
|---|--|
| Node address (Node, Addr)                   | The address of the node to be linked.                          |
| Beginning LR word (LR, Begin)               | The first LR Area word to be in the data link.                 |
| Number of LR words (LR, Wd)                 | The number of LR Area words to be in the data link.            |
| Beginning IR, HR, DM word (IR,HR,DM; Begin) | The first IR, HR, or DM Area word to be in the data link.      |
| Number of IR, HR, DM words (IR,HR,DM; Wd)   | The number of IR, HR, or DM Area words to be in the data link. |



The procedure is as follows:

- 1, 2, 3... 1. Select "E:Edit" from the SYSMAC NET Data Link Table Menu. A data link table with the specified number of nodes will be displayed in Read mode. The following display is for two nodes.

| C1000H < >    |     |             |   |                   |   | Read          | Data link table |             |  |                   |  |
|---------------|-----|-------------|---|-------------------|---|---------------|-----------------|-------------|--|-------------------|--|
| Node No. Addr |     | LR Begin Wd |   | IR,HR,DM Begin Wd |   | Node No. Addr |                 | LR Begin Wd |  | IR,HR,DM Begin Wd |  |
| 1             | 001 | LR00        | 0 | 000               | 0 |               |                 |             |  |                   |  |
| 2             | 001 | LR00        | 0 | 000               | 0 |               |                 |             |  |                   |  |

1 Read 2 Write 3 Sort

- Press F2 to change to the WRITE mode.
- Move the cursor to the position of the desired data, input the new data and press Enter. The data will be stored in the system work area as soon as it is input. The maximum number of words that can be linked for an one node is 32 words for the LR Area and 99 words for other areas.
- When you have finished inputting the data link table, press End or Escape to return to the menu.



2. Select "K:Check" from the SYSMAC NET Data Link Table Menu. The check will start immediately and any errors that are discovered will be displayed as shown in the following illustration.

C1000H < > Check Data Link 11

| Node |      | LR    |    | IR,HR,DM |    | Error message     |
|------|------|-------|----|----------|----|-------------------|
| No.  | Addr | Begin | Wd | Begin    | Wd |                   |
| 1    | 001  |       |    |          |    | Duplicate address |
| 2    | 001  |       |    |          |    | Duplicate address |
| 3    | 010  |       |    |          |    | Duplicate address |
| 4    | 010  |       |    |          |    | Duplicate address |
| 5    | 014  |       |    |          |    | Duplicate address |
| 6    | 014  |       |    |          |    | Duplicate address |
| 7    | 014  |       |    |          |    | Duplicate address |
| 8    | 022  | LR40  | 32 |          |    | Area exceed       |
| 9    | 022  |       |    |          |    | Duplicate address |
| 10   | 022  |       |    |          |    | Duplicate address |
| 11   | 022  |       |    |          |    | Duplicate address |
| 12   | 022  |       |    |          |    | Duplicate address |
| 13   | 026  |       |    |          |    | Duplicate address |
| 14   | 026  |       |    |          |    | Duplicate address |
| 15   | 026  |       |    |          |    | Duplicate address |

Continued

If no error exists in the data link table, no error messages will be displayed and the message "checked" will be displayed at the bottom center of the table.

If errors have been detected, the relevant error messages will be displayed. If too many errors have occurred to be displayed on a single screen, the message "Continued" will be displayed at the bottom center of the screen. Use PageUp and PageDown Keys to display these errors.

### 14-3-4 Clearing Data Link Tables

This command clears the data link table. You can also designate the number of nodes to appear in the data link table after it is cleared. The procedure is as follows:

- 1, 2, 3... 1. Select "C:Clear" from the SYSMAC NET Data Link Table Menu. A confirmation display will appear.

2. Press Y and Enter to clear the table. A prompt to enter the number of nodes to appear in the cleared data link table will appear.

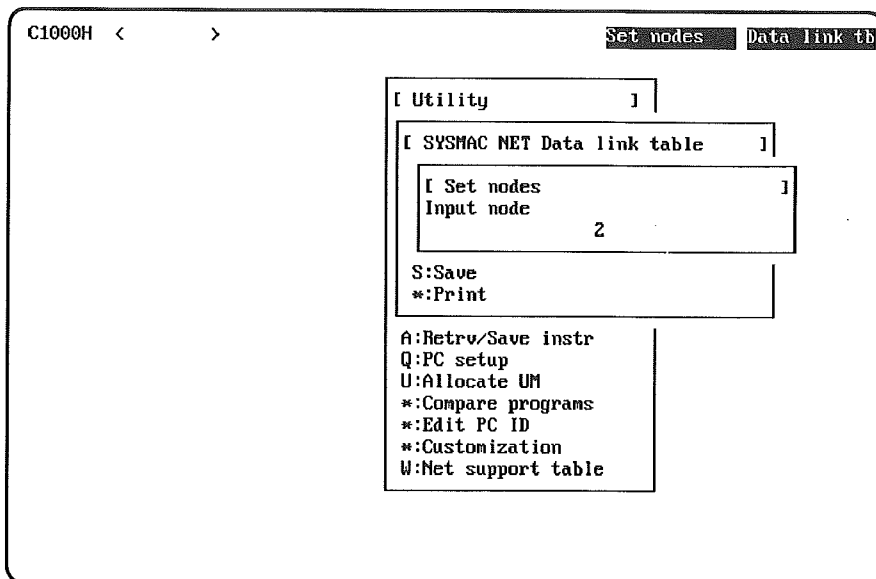

3. Input the number of nodes and press Enter. The input can be between 2 and 32 nodes.

### 14-3-5 Retrieving Data Link Tables

The Retrieve operation retrieves a data link table from a disk to the computer's system work area. An data link table currently being displayed will be lost.

The procedure is as follows:

- 1, 2, 3... 1. Select "L:Retrieve" from the SYSMAC NET Data Link Table Menu.
2. Input the name of the file to be retrieved and press Enter. The data link table under the input name will be retrieved to the system work area.

Tables can also be retrieved by pressing End while the file name input area is displayed, selecting the file name and pressing Enter.

### 14-3-6 Saving Data Link Tables

The Save operation saves a data link table from the computer's system work area to a disk. When saving to an LSS-format disk, the disk must be formatted for the same PC family as the PC specified in the System Setup.

The procedure is as follows:

- 1, 2, 3... 1. Select "S:Save:" from the SYSMAC NET Data Link Table Menu.
2. Input the name of the file to be saved and press Enter. The data link table under the input name will be saved from the system work area to the data disk.

Tables can also be saved by pressing End while the file name input area is displayed, selecting the file name and pressing Enter.

## 14-4 Transferring Data Link Tables

The online Data Link Table operation is used to transfer a data link table on the computer's system work area to the PC or to compare the data link tables in the system work area and in the PC.

This command is supported for the C200H, C1000H, or C2000H.

**Note** Transfer the SYSMAC NET data link table only to the PC which includes the SYSMAC NET Link Unit specified as the master of the data link.

The following operations appear on the Data Link Table Menu. The PC modes under which the operations are allowed are also shown.

| Operation       | Function   | PC operating mode |         |         |
|-----------------|--|-------------------|---------|---------|
|                 |  | RUN               | MONITOR | PROGRAM |
| R:PC → Computer | Reads the data link table from the PC.                       | OK                | OK      | OK      |
| W:Computer → PC | Writes the data link table from the SSS to the PC.           | NO                | NO      | OK      |
| V:Verify        | Compares the data link table in the SSS to the one in the PC | OK                | OK      | OK      |

To access the above operations, select "W:Net support table" from the online Utility Menu and then select "N:Data link (SYSMAC NET)." The following menu will appear.

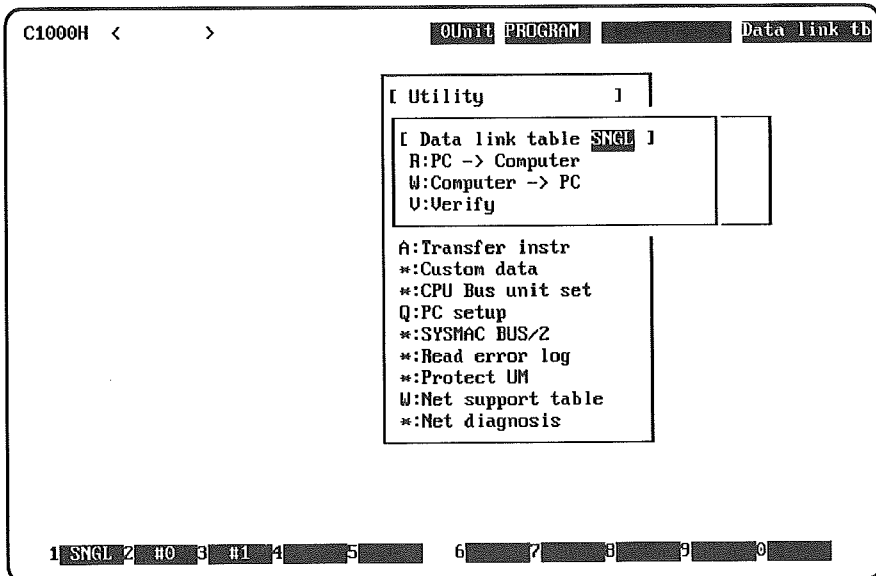

On this menu, the operating level of the data link must be specified using the F1, F2 and F3 Function Keys. Data link transfer will not operate correctly if the proper operating level is not specified.

Press F1 for a single level data link (default). This setting is used for the C500-SNT31-V1/V2/V3 SYSMAC NET Link Units.

Press F2 to specify level #0. This setting is used for level-0 data links using the C500-SNT31-V4 or C200H-SNT31 SYSMAC NET Link Units.

Press F3 to specify level #1. This setting is used for level-1 data links using the C500-SNT31-V4 or C200H-SNT31 SYSMAC NET Link Units.

### 14-4-1 Transferring to the Computer

The PC → Computer operation reads data from the PC's data link table and transfers it to the computer's system work area. The data link table displayed at the SSS will be deleted.

Use the following procedure.

- 1, 2, 3...**
1. Select "W:Net support table" from the online Utility Menu.
  2. Select "N:Data link (SYSMAC NET)."
  3. Specify the operating level using the F1, F2 and F3 Keys and press Enter.
  4. Select "R:PC → Computer"
- "Executing" will be displayed and the transfer will begin.
- When the transfer is complete, the data link table will be displayed or, if a data link table did not exist in the PC, an error message will appear.

### 14-4-2 Transferring to the PC

The Computer → PC operation reads the data link table in the SSS and writes it to the PC. The data link table in the PC will be deleted. Before executing the transfer, check the SYSMAC NET Link Unit at the PC to which the data link table is being transferred to be sure it is the Master of the data link, to be sure the data links are set for manual setting (not automatic), and to be sure the data link is not active.

Use the following procedure to transfer the data link table.

- 1, 2, 3...**
1. Select "W:Net support table" from the online Utility Menu.
  2. Select "N:Data link (SYSMAC NET)."
  3. Specify the operating level using the F1, F2 and F3 Keys and press Enter.
  4. Select "W:Computer → PC"
- "Executing" will be displayed and the transfer will begin.
- When the transfer is complete, the menu will be displayed.

### 14-4-3 Comparing Data Link Tables

The Verify operation is used to compare the data link table in the computer's system work area to the data link table in a PC. This operation is normally used after first transferring a data link table from or to a PC to be sure the transfer operation was successful.

Use the following procedure to compare the data link tables.

- 1, 2, 3...**
1. Select "W:Net support table" from the online Utility Menu.
  2. Select "N:Data link (SYSMAC NET)."
  3. Specify the operating level using the F1, F2 and F3 Keys and press Enter.
  4. Select "V:Verify"
- "Executing" will be displayed and the comparison will begin.

5. When the transfer is complete, the following will be displayed .

| Node No. Addr |  | LR Begin Wd |    | IR,HR,DM Begin Wd |    | Node No. Addr |  | LR Begin Wd |  | IR,HR,DM Begin Wd |    |
|---------------|--|-------------|----|-------------------|----|---------------|--|-------------|--|-------------------|----|
| 4             |  |             |    | DM0000            | 99 | 15            |  |             |  | 000               | 0  |
|               |  |             |    | 000               | 0  |               |  |             |  | HR03              | 3  |
| 6             |  |             | 0  | HR00              | 3  | 16            |  | 0           |  | DM0000            | 10 |
|               |  |             | 10 | DM0000            | 99 |               |  | 10          |  | 000               | 0  |
| 7             |  | LR40        | 32 | DM0140            | 40 | 18            |  |             |  | DM0000            | 0  |
|               |  | LR00        | 10 | DM0000            | 99 |               |  |             |  | HR00              | 3  |
| 9             |  |             |    | DM0000            | 10 | 19            |  |             |  | 000               | 0  |
|               |  |             |    | HR03              | 3  |               |  |             |  | HR00              | 3  |
| 10            |  | LR40        |    | DM4096            | 40 | 20            |  |             |  | DM0000            | 0  |
|               |  | LR00        |    | HR03              | 3  |               |  |             |  | HR00              | 3  |
| 11            |  |             | 22 | DM4096            | 40 |               |  |             |  | HR00              | 3  |
|               |  |             | 0  | HR03              | 3  |               |  |             |  | DM0000            | 0  |
| 12            |  |             |    | DM0000            | 10 |               |  |             |  | HR00              | 3  |
|               |  |             |    | HR03              | 3  |               |  |             |  | 000               | 0  |
| 14            |  |             |    | 000               | 0  |               |  |             |  | HR03              | 3  |
|               |  |             |    | HR03              | 3  |               |  |             |  |                   |    |

Complete

- 6. If "Continue" is displayed at the bottom of the screen, use the PageUp and Page-Down Keys to view any errors not currently displayed.
- 7. If any errors are displayed, transfer the data link tables again.

## 14-5 Creating and Modifying Routing Tables

Routing tables are required in SYSMAC NET systems to execute communications between two or more interconnected networks. A routing table is not required unless the SSS is going to be used to communicate with remote networks.

The routing table for the SSS is input offline under the System Setup Menu. Transferring routing tables to other nodes is not possible.

**Example System** The following network will be used in describing routing tables.

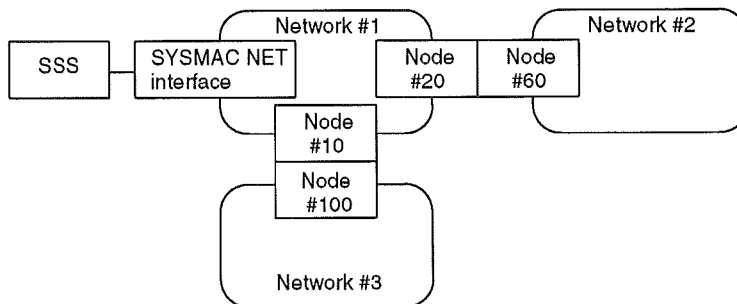

The following routing table is required for the SSS, which is connected to network #1, to communicate with PCs on networks #2 and #3. The network number is the number of the network with which communications will be made; the bridge address is the node address on the local network of the bridge that connects to the remote network.

| Network number | Bridge address |
|----------------|----------------|
| 002            | 020            |
| 003            | 010            |

**Procedure**

Use the following procedure to set a routing table for the SSS.

- 1, 2, 3... 1. Access the System Setup by selecting "Setup" from the top-level offline menu.

2. Select "C:PC interface" from the System Setup Menu.
3. Select "S:SYSMAC NET."
4. Select "R:Routing." The following routing table edit display will appear.

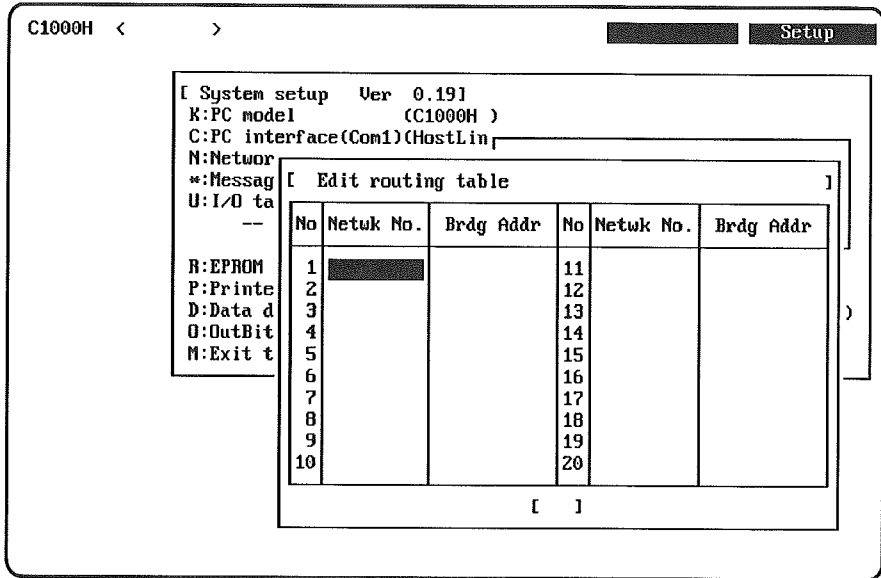

5. Input a network number between 1 and 127 and press Enter.
6. Input the bridge address for the network between 1 and 126 and press Enter.
7. Continue setting all required networks and bridges.
8. If you need to delete an network and the corresponding bridge address, move the cursor to the network number and press F9. The data for that network will be deleted.
9. Press F10 to save the routing table to the system work area. (If Escape is pressed, the edit display will be exited without saving any data that has been input.)



# SECTION 15

## SYSMAC LINK Data Link Communications

This section provides information on setting up, controlling, and maintaining data links in a SYSMAC LINK network.

|        |  |     |
|--------|--|-----|
| 15-1   | Introduction .....                             | 354 |
| 15-2   | Offline SYSMAC LINK Data Link Table Menu ..... | 355 |
| 15-2-1 | Editing Data Link Tables .....                 | 357 |
| 15-2-2 | Checking Data Link Tables .....                | 359 |
| 15-2-3 | Copying Data Link Tables .....                 | 361 |
| 15-2-4 | Clearing Data Link Tables .....                | 362 |
| 15-2-5 | Retrieving Data Link Tables .....              | 362 |
| 15-2-6 | Saving Data Link Tables .....                  | 362 |
| 15-3   | Online SYSMAC LINK Data Link Table Menu .....  | 363 |
| 15-3-1 | Retrieving Data Link Tables .....              | 364 |
| 15-3-2 | Transferring Data Link Tables .....            | 365 |
| 15-3-3 | Deleting Data Link Tables .....                | 370 |
| 15-3-4 | Saving Data Link Tables .....                  | 371 |
| 15-3-5 | Starting and Stopping the Data Link .....      | 372 |
| 15-3-6 | Monitoring the Data Link .....                 | 372 |
| 15-3-7 | Displaying a Node's Error Status .....         | 375 |
| 15-3-8 | Setting the Network Parameters .....           | 376 |

## 15-1 Introduction

This section provides an overview of the data link function in SYSMAC LINK Systems. Refer to the SYSMAC LINK System Manual for details on data link tables, data link areas, or information such as network configuration.

Data links can be established between PCs and computers on a SYSMAC NET or SYSMAC LINK network to exchange data automatically. To achieve automatic data exchange, data link tables are established at each node to specify the words that are to be exchanged. The result is that the nodes share data in what are called common data areas, i.e., the data areas linked at each of the nodes is exactly the same as the corresponding areas at the other nodes. Each node thus has certain words to which it writes data called write words and words written by other nodes called read words (i.e., the local node can only read words written by other nodes).

**Data Link Tables** The data link tables contain parameters necessary to automatically transfer data between the nodes in the data link. In the SYSMAC LINK data tables, there are common link parameters shared by all of the nodes in the network and refresh parameters set in each node.

The data link tables must be established before any data link communications are possible. There are two ways to establish data link tables: automatically and manually.

### Automatic Generation

The operations described in this manual to create and edit data link tables are not necessary if the system is set up to automatically generate data link tables.

### Manual Generation

Manually establishing data link tables involves inputting data link tables on the SSS or host computers and transferring them to the PCs and other participating nodes. The operations required to input and transfer the data link tables using the SSS are described in the rest of this section.

### Overall Procedure

Follow the procedure below to manually generate and transfer data link tables. Be sure to read the rest of this section before attempting to carry out this procedure.

#### 1, 2, 3...

1. Set all of the PCs in the data link for manual data link table generation by force-resetting (forcing OFF) the Data Link Setting Bits with the Programming Console's Forced Set/Reset operation. The control bits are the same in C200H, C200HS, C200HX/HG/HE, C1000H, and C2000H PCs.

| Operating level    | Data Link Setting Bits |
|--------------------|------------------------|
| Operating level #0 | AR 0700 and AR 0701    |
| Operating level #1 | AR 0704 and AR 0705    |

2. Set the PC Interface to "Peripheral Bus (via SYSMAC LINK)" or "Host Link (via SYSMAC LINK)". See *6-2-2 PC Interface*.
3. Set the SYSMAC LINK operating level in the PC Interface. See *6-2-2 PC Interface*.
4. Select "Data link tables (SYSMAC LINK)" from the Utility Menu. See *15-2 Offline SYSMAC LINK Data Link Table Menu*.
5. Create the data link table. See *15-2-1 Editing Data Link Tables*.
6. Check the data link table. See *15-2-2 Checking Data Link Tables*.
7. Save the data link table. See *15-2-6 Saving Data Link Tables*.
8. Connect to the SYSMAC LINK network.
9. Switch to online operation. See *15-3 Online SYSMAC LINK Data Link Table Menu*.
10. Retrieve the data link table. See *15-3-1 Retrieving Data Link Tables*.
11. Transfer the data link table to the PC. See *15-3-2 Transferring Data Link Tables*.
12. Start the data link. See *15-3-5 Starting and Stopping the Data Link*.

## 15-2 Offline SYSMAC LINK Data Link Table Menu

This section explains how to create the SYSMAC LINK System's data link tables, which must be created when the data link area in the SYSMAC LINK Unit is set for manual generation. Refer to the *SYSMAC LINK System Manual* for details on the SYSMAC LINK Unit's data link area.

Be sure to save the edited data link tables on data disk using the procedure in 15-2-6 *Saving Data Link Tables*. Data edited with operations in the data link table menu are stored in the computer's RAM, not in the system work area, so the data will be lost if the power is turned off, the computer is reset, or SSS is switched to the Utility menu by pressing Esc+Ctrl+\.

### Menu Operations

The following table lists the operations in the offline SYSMAC LINK Data Link Table Menu.

| Operation                | Function   |
|--------------------------|--|
| Edit data link table     | Creates or edits data link tables.                                 |
| Check data link table    | Checks new or edited data link tables for errors.                  |
| Copy data link table     | Copies the specified node's refresh parameters to other nodes.     |
| Clear data link table    | Deletes the current data link table information.                   |
| Save data link table     | Saves the current data link table information to data disk.        |
| Retrieve data link table | Retrieves and displays data link table information from data disk. |

### Displaying the Menu

Follow the procedure below to access the offline SYSMAC LINK Data Link Table Menu.

- 1, 2, 3... 1. Select "W:Net support table" from the Utility Menu.

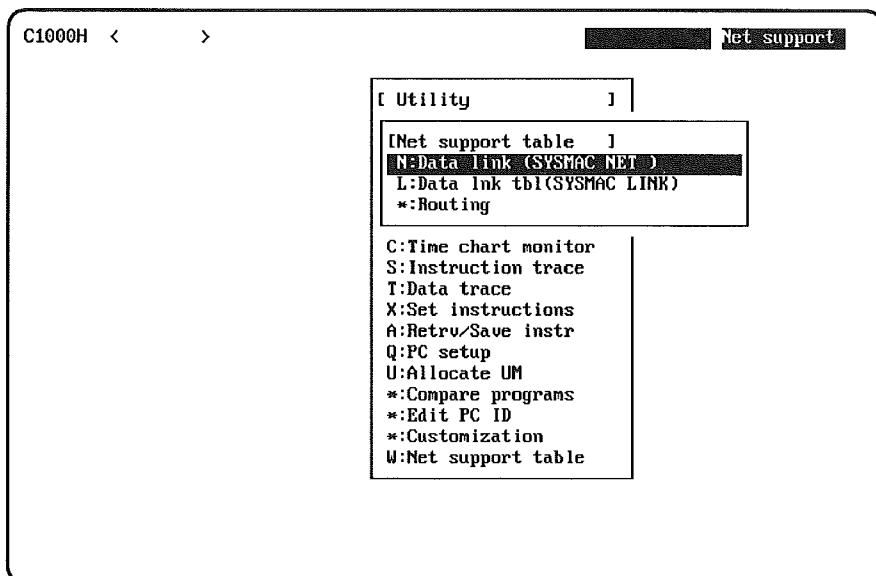

- Select "L:Data lnk tbl (SYSMAC LINK)." The common link parameters display will appear with the default settings. Saved settings can be displayed by executing the Retrieve Data Link Table operation.

Display Common param

Comm cycle=[ ---ms ]

| Node | LR | DM | Node | LR | DM | Node | LR | DM | Node | LR | DM |
|------|----|----|------|----|----|------|----|----|------|----|----|
| 1    | 1  | 1  | 17   | -  | -  | 33   | -  | -  | 49   | -  | -  |
| 2    | 1  | 1  | 18   | -  | -  | 34   | -  | -  | 50   | -  | -  |
| 3    | -  | -  | 19   | -  | -  | 35   | -  | -  | 51   | -  | -  |
| 4    | -  | -  | 20   | -  | -  | 36   | -  | -  | 52   | -  | -  |
| 5    | -  | -  | 21   | -  | -  | 37   | -  | -  | 53   | -  | -  |
| 6    | -  | -  | 22   | -  | -  | 38   | -  | -  | 54   | -  | -  |
| 7    | -  | -  | 23   | -  | -  | 39   | -  | -  | 55   | -  | -  |
| 8    | -  | -  | 24   | -  | -  | 40   | -  | -  | 56   | -  | -  |
| 9    | -  | -  | 25   | -  | -  | 41   | -  | -  | 57   | -  | -  |
| 10   | -  | -  | 26   | -  | -  | 42   | -  | -  | 58   | -  | -  |
| 11   | -  | -  | 27   | -  | -  | 43   | -  | -  | 59   | -  | -  |
| 12   | -  | -  | 28   | -  | -  | 44   | -  | -  | 60   | -  | -  |
| 13   | -  | -  | 29   | -  | -  | 45   | -  | -  | 61   | -  | -  |
| 14   | -  | -  | 30   | -  | -  | 46   | -  | -  | 62   | -  | -  |
| 15   | -  | -  | 31   | -  | -  | 47   | -  | -  |      |    |    |
| 16   | -  | -  | 32   | -  | -  | 48   | -  | -  |      |    |    |

1 Node 2 Common 3 4 5 6 7 8 9 0

Press the PageUp or PageDown Keys to display each node's refresh parameters, as shown in the following diagram. A particular node's refresh parameters can be displayed by pressing the F1 Key and inputting the node number.

Display Refresh para

[Node addr= 1 ]  
 PC=[ C1000H] 1stRefreshWd=[ LR 00] DM 0000] 1stStatusWd=[ DM 0200]

| No. | Node | LR | DM | No. | Node | LR | DM | No. | Node | LR | DM | No. | Node | LR | DM |
|-----|------|----|----|-----|------|----|----|-----|------|----|----|-----|------|----|----|
| 1   | 1    | 1  | 1  | 17  |      |    |    | 33  |      |    |    | 49  |      |    |    |
| 2   | 2    | 1  | 1  | 18  |      |    |    | 34  |      |    |    | 50  |      |    |    |
| 3   |      |    |    | 19  |      |    |    | 35  |      |    |    | 51  |      |    |    |
| 4   |      |    |    | 20  |      |    |    | 36  |      |    |    | 52  |      |    |    |
| 5   |      |    |    | 21  |      |    |    | 37  |      |    |    | 53  |      |    |    |
| 6   |      |    |    | 22  |      |    |    | 38  |      |    |    | 54  |      |    |    |
| 7   |      |    |    | 23  |      |    |    | 39  |      |    |    | 55  |      |    |    |
| 8   |      |    |    | 24  |      |    |    | 40  |      |    |    | 56  |      |    |    |
| 9   |      |    |    | 25  |      |    |    | 41  |      |    |    | 57  |      |    |    |
| 10  |      |    |    | 26  |      |    |    | 42  |      |    |    | 58  |      |    |    |
| 11  |      |    |    | 27  |      |    |    | 43  |      |    |    | 59  |      |    |    |
| 12  |      |    |    | 28  |      |    |    | 44  |      |    |    | 60  |      |    |    |
| 13  |      |    |    | 29  |      |    |    | 45  |      |    |    | 61  |      |    |    |
| 14  |      |    |    | 30  |      |    |    | 46  |      |    |    | 62  |      |    |    |
| 15  |      |    |    | 31  |      |    |    | 47  |      |    |    |     |      |    |    |
| 16  |      |    |    | 32  |      |    |    | 48  |      |    |    |     |      |    |    |

1 Node 2 Common 3 4 5 6 7 8 9 0

Press the F2 Key to return to the common link parameters display.

- Press the End Key from the data link table display (common link parameters or refresh parameters) to bring up the SYSMAC LINK Data Link Table Menu.

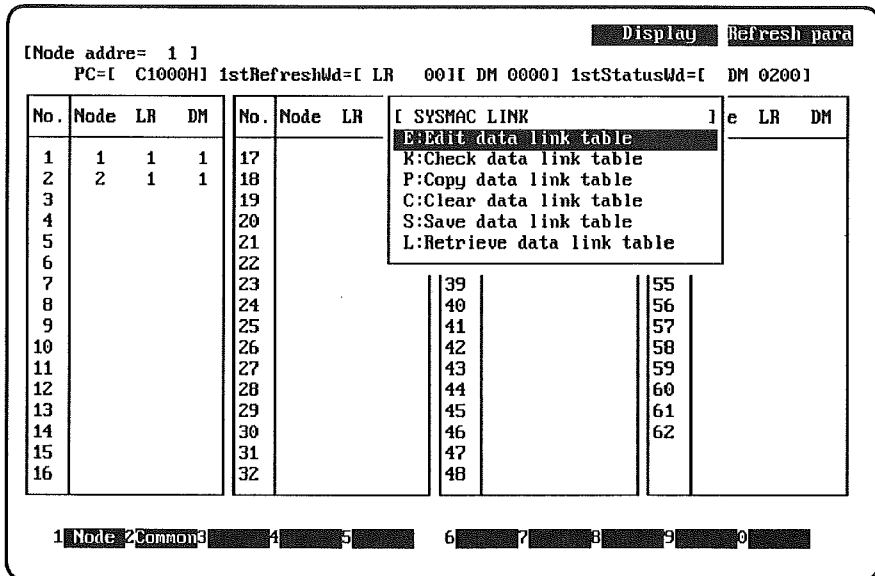

- Select the desired operation.

**Exiting**

Follow the procedure below to exit the SYSMAC LINK data link table operations. The exiting procedure for data link table operations is different because edited data will be lost if it isn't saved to data disk.

1, 2, 3...

- Press the End Key from the data link table display (common link parameters or refresh parameters) to bring up the SYSMAC LINK Data Link Table Menu.
- Press the Escape Key. A confirmation prompt will be displayed.
- Press "Y" and Enter to exit the data link table operations.  
If there is data that needs to be saved, press Enter and execute the Save Data Link Tables operation.

**15-2-1 Editing Data Link Tables**

This operation is used to set the common link parameters and refresh parameters. Refer to the *SYSMAC LINK System Manual* for more details on these parameters.

**Common Link Parameters**

The following table lists the common link parameters.

| Parameter                 | Function  |
|---------------------------|---|
| Communications cycle time | This is the time for the token to make a circuit through the nodes in the data link. Normally, the default setting (variable cycle time) is used and it isn't necessary to set a fixed cycle time.<br><br>When setting a fixed cycle time for a system in which the communications cycle time varies due to noise, be sure to set a cycle time greater than the maximum cycle time. The data link might not operate properly if this parameter is set to a value less than the actual cycle time. |
| Number of LR words        | Set the number of LR words transmitted by each node.  |
| Number of DM words        | Set the number of DM words transmitted by each node.  |

**Refresh Parameters**

The following table lists the refresh parameters.

| Parameter           | Function  |
|---------------------|---|
| PC model            | Set the PC model of the node for which the parameters are being edited.   |
| First refresh words | Set the first LR and DM addresses for the node's data link.   |
| First status word   | Set the word address where the first of the data link status area is allocated.<br>Four bits in the status area are required for each node. |
| Node numbers        | Set the node numbers of the local node and the nodes that will link to the local node.  |

**Procedure**

The data link editing procedure is as follows:

1, 2, 3...

1. Select "E:Edit data link table" from the SYSMAC LINK Data Link Table Menu.

Edit
Common param

Comm cycle=[ ---ms ]

| Node | LR | DM | Node | LR | DM | Node | LR | DM | Node | LR | DM |
|------|----|----|------|----|----|------|----|----|------|----|----|
| 1    | 1  | 1  | 17   | -  | -  | 33   | -  | -  | 49   | -  | -  |
| 2    | 1  | 1  | 18   | -  | -  | 34   | -  | -  | 50   | -  | -  |
| 3    | -  | -  | 19   | -  | -  | 35   | -  | -  | 51   | -  | -  |
| 4    | -  | -  | 20   | -  | -  | 36   | -  | -  | 52   | -  | -  |
| 5    | -  | -  | 21   | -  | -  | 37   | -  | -  | 53   | -  | -  |
| 6    | -  | -  | 22   | -  | -  | 38   | -  | -  | 54   | -  | -  |
| 7    | -  | -  | 23   | -  | -  | 39   | -  | -  | 55   | -  | -  |
| 8    | -  | -  | 24   | -  | -  | 40   | -  | -  | 56   | -  | -  |
| 9    | -  | -  | 25   | -  | -  | 41   | -  | -  | 57   | -  | -  |
| 10   | -  | -  | 26   | -  | -  | 42   | -  | -  | 58   | -  | -  |
| 11   | -  | -  | 27   | -  | -  | 43   | -  | -  | 59   | -  | -  |
| 12   | -  | -  | 28   | -  | -  | 44   | -  | -  | 60   | -  | -  |
| 13   | -  | -  | 29   | -  | -  | 45   | -  | -  | 61   | -  | -  |
| 14   | -  | -  | 30   | -  | -  | 46   | -  | -  | 62   | -  | -  |
| 15   | -  | -  | 31   | -  | -  | 47   | -  | -  |      |    |    |
| 16   | -  | -  | 32   | -  | -  | 48   | -  | -  |      |    |    |

1 Node
2 Common
3
4
5
6
7
8 Enable
9 Disable
0 End

2. Input the common link parameters by moving the cursor to each parameter and inputting the desired value.

| Parameter                 | Function  |
|---------------------------|---|
| Communications cycle time | Normally, the default setting of "--- ms" (variable cycle time) is used.<br><br>When setting a fixed cycle time, the setting range is 5 to 255 ms. To return to variable cycle times after a fixed cycle time has been set, press the Home Key twice.   |
| Number of LR words        | Input the desired value for each address and press Enter.<br><br>Except for nodes 1 and 2, the default setting for the number of words is "-". This setting indicates that there are no LR or DM words in the data link and that the data link status area won't be refreshed.  |
| Number of DM words        | A setting of "0" indicates that there are no LR or DM words in the data link, but the data link status area will be refreshed.<br><br>The setting range for the number of LR words is 1 to 64.<br>The setting range for the number of DM words is 1 to 254.<br><br>Make sure that the sum total of all LR words and DM words does not exceed 2,966 words. |

3. Press the PageDown Key to bring up the refresh parameters display and input the refresh parameters for each node.

The refresh parameter display won't be displayed for nodes that aren't in the data link. To enable a node that isn't in the data link, press the F8 Key and enter the number of refresh nodes. That node's refresh parameters will be displayed.

Edit
Refresh para

[Node addr= 1 ]  
 PC=[ C1000H] 1stRefreshWd=[ LR 00] [ DM 0000] 1stStatusWd=[ DM 0200]

| No. | Node | LR | DM | No. | Node | LR | DM | No. | Node | LR | DM | No. | Node | LR | DM |
|-----|------|----|----|-----|------|----|----|-----|------|----|----|-----|------|----|----|
| 1   | 1    | 1  | 1  | 17  |      |    |    | 33  |      |    |    | 49  |      |    |    |
| 2   | 2    | 1  | 1  | 18  |      |    |    | 34  |      |    |    | 50  |      |    |    |
| 3   |      |    |    | 19  |      |    |    | 35  |      |    |    | 51  |      |    |    |
| 4   |      |    |    | 20  |      |    |    | 36  |      |    |    | 52  |      |    |    |
| 5   |      |    |    | 21  |      |    |    | 37  |      |    |    | 53  |      |    |    |
| 6   |      |    |    | 22  |      |    |    | 38  |      |    |    | 54  |      |    |    |
| 7   |      |    |    | 23  |      |    |    | 39  |      |    |    | 55  |      |    |    |
| 8   |      |    |    | 24  |      |    |    | 40  |      |    |    | 56  |      |    |    |
| 9   |      |    |    | 25  |      |    |    | 41  |      |    |    | 57  |      |    |    |
| 10  |      |    |    | 26  |      |    |    | 42  |      |    |    | 58  |      |    |    |
| 11  |      |    |    | 27  |      |    |    | 43  |      |    |    | 59  |      |    |    |
| 12  |      |    |    | 28  |      |    |    | 44  |      |    |    | 60  |      |    |    |
| 13  |      |    |    | 29  |      |    |    | 45  |      |    |    | 61  |      |    |    |
| 14  |      |    |    | 30  |      |    |    | 46  |      |    |    | 62  |      |    |    |
| 15  |      |    |    | 31  |      |    |    | 47  |      |    |    |     |      |    |    |
| 16  |      |    |    | 32  |      |    |    | 48  |      |    |    |     |      |    |    |

1 Node
2 Common
3
4
5
6
7
8 Enable
9 Disble
0 End

Move the cursor to the parameter you want to change and input the new value.

| Parameter           | Function   |
|---------------------|--|
| PC model            | Set the PC model to C200H, C200H*, C1000H, or C2000H. (C200H* represents C200HS or C200HX/HG/HE PCs.) Use the Space Bar or Backspace Key to select the desired PC model and press Enter.   |
| First refresh words | Enter the first LR and DM addresses.   |
| First status word   | Enter the data link status area's first word address. Four bits in the status area are required for each node.   |
| Node numbers        | <p>Enter the node numbers. The local node's node number must be entered.</p> <p>Do not use any node number more than once or the node number of a node that isn't set in the common link parameters.</p> <p>Data will be transmitted from the local node if the node number of the node being edited is set. If a different node number is set, data will be received from that node.</p> <p>The Insert Key can be pressed to insert a new node number within node numbers that have already been entered.</p> <p>The Delete Key can be pressed to delete a node number.</p> |
| LR words, DM words  | <p>When a node number is entered, the number of LR and DM words set in the common link parameters will be displayed automatically.</p> <p>Words are allocated to the nodes in the order that they are entered in the table, starting from the "first refresh words."</p> <p>Press the Home Key when the cursor is located at a "0" setting. (A "0" setting indicates that the data link status will be refreshed, but no data will be transferred.)</p>  |

### 15-2-2 Checking Data Link Tables

This operation checks data link table for errors. The check is performed on the data link table that is currently displayed, so the Retrieve Data Link Table operation must be executed if the desired data link table isn't displayed.

Nodes that aren't set in the common link parameters aren't checked for errors.

**Note** Always check any data link table that has been newly input or modified. If any errors are found in the table, correct them using the Edit operation and then check the table again.

**Procedure** Select "K:Check data link table" from the SYSMAC LINK Data Link Table Menu. The common link parameters and refresh parameters in each node will be checked and any errors that are discovered will be displayed as shown in the following illustration.

Check    Link Table

Common link paramete

| Node | Error message | Node | Error message |
|------|---------------|------|---------------|
|      |               |      |               |

Check Okay

If too many errors have occurred to be displayed on a single screen, the message "Continued" will be displayed at the bottom center of the screen. Press the PageDown Key to display the next page.

Check    Link Table

[ Node addr= 3 ]  
Refresh parameters

| No. | Node | Error message              | No. | Node | Error message |
|-----|------|----------------------------|-----|------|---------------|
|     |      | No send area at local node |     |      |               |

LastScreen

Press the PageUp Key to display the previous page.



**Errors**

The following table shows the errors that can occur in the common link parameters.

| Error message               | Probable cause  | Remedy   |
|-----------------------------|---|--|
| Comm cycle time range error | The communications cycle time isn't set to "--- ms" (variable cycle time) or 5 to 255 ms. | Set the cycle time to 5 to 255 ms or press the Home Key to set the cycle time to "--- ms". |
| Too many LR link words      | The number of LR words setting exceeds 64.  | Set the number of LR words to 64 or fewer.   |
| Too many DM link words      | The number of DM words setting exceeds 254.   | Set the number of DM words to 254 or fewer.  |
| Too many data link words    | The total number of LR and DM words used in all of the nodes exceeds the maximum.         | Reduce the number of words below the maximum. (See note.)                                  |

**Note** The maximum number of link words is 918 words for data links with a C200H or 2,966 words for a data link without a C200H.

The following table shows the errors that can occur in the refresh parameters.

| Error message                | Probable cause  | Remedy  |
|------------------------------|---|---|
| # of refresh nodes msg error | The number of link nodes is not in the range 2 to 62.                     | Set the number of nodes within the range 2 to 62.                                 |
| 1st LR word range error      | The first LR word address exceeds 63.                                     | Set the first LR word address to 63 or lower.                                     |
| 1st DM word range error      | The first DM word address exceeds the maximum.                            | Set the first DM word address below the maximum.                                  |
| 1st status wrd range error   | The first status word is not within a usable range.                       | Set the first status word to a usable word address.                               |
| 1st status setting error     | The status area is too small.   | Set the first status word low enough to provide enough space for the status area. |
| Node address range error     | The node number is not in the range 1 to 62.                              | Set the node number within the range 1 to 62.                                     |
| Node address duplicated      | A node number has been used more than once.                               | Change the node number so that each number is unique.                             |
| Node address setting error   | A node number that isn't set in the common link parameters has been used. | Set the node number in the common link parameters.                                |
| 1st LR word setting error    | The number of LR words used exceeds the LR area boundary.                 | Reduce the number of LR words used or lower the first LR word setting.            |
| 1st DM word setting error    | The number of DM words used exceeds the DM area boundary.                 | Reduce the number of DM words used or lower the first DM word setting.            |
| No send area at local node   | There is no link area in the local node.                                  | Set the local node number in the refresh parameters.                              |

### 15-2-3 Copying Data Link Tables

This operation is used to copy a node's refresh parameters to one or more other nodes. The data in the destination nodes is overwritten when this operation is executed, so be sure that the refresh parameters in the destination nodes aren't needed.

- 1, 2, 3...** 1. Select "P:Copy data link table" from the SYSMAC LINK Data Link Table Menu.

- Enter the node number (1 to 62) of the source node. A node number that isn't set in the common link parameters can't be specified as the source node. The following display will appear for specifying the destination node(s).

Copy Link Table

Comm cycle=[ ---ms ]

|      |    |    |      |    |                          |    |
|------|----|----|------|----|--------------------------|----|
| Node | LR | DM | Node | LR | [ SYSMAC LINK ]          | DM |
| 1    | 1  | 1  | 17   | -  | [ Copy Data Link Table ] |    |

Node Designation

Input address of copy destination Copy source: 1

| Node | Desg | Node | Desg | Node | Desg | Node | Desg | Node | Desg | Node | Desg    |
|------|------|------|------|------|------|------|------|------|------|------|---------|
| 2    | 0    | 11   | 21   | 31   | 41   | 51   | 61   |      |      |      |         |
| 3    |      | 12   | 22   | 32   | 42   | 52   | 62   |      |      |      |         |
| 4    |      | 13   | 23   | 33   | 43   | 53   |      |      |      |      |         |
| 5    |      | 14   | 24   | 34   | 44   | 54   |      |      |      |      |         |
| 6    | 0    | 15   | 25   | 35   | 45   | 55   |      |      |      |      |         |
| 7    | 0    | 16   | 26   | 36   | 46   | 56   |      |      |      |      |         |
| 8    | 0    | 17   | 27   | 37   | 47   | 57   |      |      |      |      |         |
| 9    | 0    | 18   | 28   | 38   | 48   | 58   |      |      |      |      |         |
| 10   | 0    | 19   | 29   | 39   | 49   | 59   |      |      |      |      |         |
|      |      | 20   | 30   | 40   | 50   | 60   |      |      |      |      | Execute |

1 Node 2 Common 3 4 5 6 7 8 9 0

- Specify the destination node(s) by moving the cursor to the desired node(s) and pressing Enter. Circles will be displayed next to the selected node numbers. (To cancel a selection move the cursor to the node and press Enter again.)
- To copy the parameters, move the cursor to "Execute" in the lower-right corner of the display and press Enter. Specified destination nodes that aren't in the data link will be added to the data link during the copy operation. The common link parameters will be displayed when the copy operation is completed.

### 15-2-4 Clearing Data Link Tables

This operation is used to clear the contents of the currently displayed data link table and return it to the default settings. The default settings have nodes 1 and 2 enabled and all other nodes disabled.

- 1, 2, 3...
- Select "C:Clear data link table" from the SYSMAC LINK Data Link Table Menu. A confirmation prompt will be displayed.
  - Press "Y" and Enter to clear the data link table. Press Enter to cancel the operation.

### 15-2-5 Retrieving Data Link Tables

This operation retrieves and displays a data link table from a disk. The data link table being displayed when this operation is executed will be overwritten. Be sure to save the current data link table to disk if it is needed.

- 1, 2, 3...
- Select "L:Retrieve data link table" from the SYSMAC LINK Data Link Table Menu.
  - Input the name of the file to be retrieved and press Enter. The specified data link table will be retrieved.
- A directory of the files on the disk can be displayed by pressing End while the file name input area is displayed. A file can then be selected from the directory.

### 15-2-6 Saving Data Link Tables

This operation saves the currently displayed data link table to a disk. Use a data disk formatted with the MS-DOS format.

- 1, 2, 3... 1. Select "S:Save data link table" from the SYSMAC LINK Data Link Table Menu.
2. Input the name of the file and press Enter or display a directory of the files on the disk by pressing End. A file can then be selected from the directory.

### 15-3 Online SYSMAC LINK Data Link Table Menu

This section explains how to execute online data link operations, such as transferring or deleting data link tables, starting the data link, and stopping the data link.

#### Menu Operations

The following table lists the operations in the online SYSMAC LINK Data Link Table Menu.

| Operation                | Function  |
|--------------------------|---|
| Transfer data link table | Transfers or compares data link tables between the PC and computer.               |
| Delete data link table   | Deletes the PC's data link tables for errors and displays errors.                 |
| Save data link table     | Saves the current data link table information to data disk.                       |
| Retrieve data link table | Retrieves and displays data link table information from data disk.                |
| Start/Stop data link     | Starts or stops the data link.  |
| Data link monitor        | Monitors the data link status, communications cycle time, and refresh cycle time. |
| Read node status         | Displays Unit error information.  |
| Set network parameters   | Sets the maximum node number and reduces the cycle time.                          |

#### Displaying the Menu

Follow the procedure below to access the online SYSMAC LINK Data Link Table Menu.

- 1, 2, 3... 1. Display the data link table offline, press Control+O, and then the F1 Key to establish the online connection.
2. Select "L:Data lnk tbl (SYSMAC LINK)" from the Network Support Table menu. The common link parameters display will appear with the default settings.

#1 Stopped   Display   Common param

Comm cycle=[ ---ms ]

| Node | LR | DM | Node | LR | DM | Node | LR | DM | Node | LR | DM |
|------|----|----|------|----|----|------|----|----|------|----|----|
| 1    | 1  | 1  | 17   | -  | -  | 33   | -  | -  | 49   | -  | -  |
| 2    | 1  | 1  | 18   | -  | -  | 34   | -  | -  | 50   | -  | -  |
| 3    | -  | -  | 19   | -  | -  | 35   | -  | -  | 51   | -  | -  |
| 4    | -  | -  | 20   | -  | -  | 36   | -  | -  | 52   | -  | -  |
| 5    | -  | -  | 21   | -  | -  | 37   | -  | -  | 53   | -  | -  |
| 6    | -  | -  | 22   | -  | -  | 38   | -  | -  | 54   | -  | -  |
| 7    | -  | -  | 23   | -  | -  | 39   | -  | -  | 55   | -  | -  |
| 8    | -  | -  | 24   | -  | -  | 40   | -  | -  | 56   | -  | -  |
| 9    | -  | -  | 25   | -  | -  | 41   | -  | -  | 57   | -  | -  |
| 10   | -  | -  | 26   | -  | -  | 42   | -  | -  | 58   | -  | -  |
| 11   | -  | -  | 27   | -  | -  | 43   | -  | -  | 59   | -  | -  |
| 12   | -  | -  | 28   | -  | -  | 44   | -  | -  | 60   | -  | -  |
| 13   | -  | -  | 29   | -  | -  | 45   | -  | -  | 61   | -  | -  |
| 14   | -  | -  | 30   | -  | -  | 46   | -  | -  | 62   | -  | -  |
| 15   | -  | -  | 31   | -  | -  | 47   | -  | -  |      |    |    |
| 16   | -  | -  | 32   | -  | -  | 48   | -  | -  |      |    |    |

1 Node 2 Common 3 4 5 6 7 8 9 0

A data link table on the data disk can be displayed by executing the Retrieve Data Link Table operation and a data link table from a PC can be displayed by executing the Transfer Data Link Table (SYSMAC LINK → Computer) operation.

Press the PageUp or PageDown Keys to display each node's refresh parameters, as shown in the following diagram. A particular node's refresh parameters can be displayed by pressing the F1 Key and inputting the node number.

#1 Stopped    Display    Refresh para

[Node addr= 1 ]  
 PC=[ C1000H] 1stRefreshWd=[ LR 00] [ DM 0000] 1stStatusWd=[ DM 0200]

| No. | Node | LR | DM | No. | Node | LR | DM | No. | Node | LR | DM | No. | Node | LR | DM |
|-----|------|----|----|-----|------|----|----|-----|------|----|----|-----|------|----|----|
| 1   | 1    | 1  | 1  | 17  |      |    |    | 33  |      |    |    | 49  |      |    |    |
| 2   | 2    | 1  | 1  | 18  |      |    |    | 34  |      |    |    | 50  |      |    |    |
| 3   |      |    |    | 19  |      |    |    | 35  |      |    |    | 51  |      |    |    |
| 4   |      |    |    | 20  |      |    |    | 36  |      |    |    | 52  |      |    |    |
| 5   |      |    |    | 21  |      |    |    | 37  |      |    |    | 53  |      |    |    |
| 6   |      |    |    | 22  |      |    |    | 38  |      |    |    | 54  |      |    |    |
| 7   |      |    |    | 23  |      |    |    | 39  |      |    |    | 55  |      |    |    |
| 8   |      |    |    | 24  |      |    |    | 40  |      |    |    | 56  |      |    |    |
| 9   |      |    |    | 25  |      |    |    | 41  |      |    |    | 57  |      |    |    |
| 10  |      |    |    | 26  |      |    |    | 42  |      |    |    | 58  |      |    |    |
| 11  |      |    |    | 27  |      |    |    | 43  |      |    |    | 59  |      |    |    |
| 12  |      |    |    | 28  |      |    |    | 44  |      |    |    | 60  |      |    |    |
| 13  |      |    |    | 29  |      |    |    | 45  |      |    |    | 61  |      |    |    |
| 14  |      |    |    | 30  |      |    |    | 46  |      |    |    | 62  |      |    |    |
| 15  |      |    |    | 31  |      |    |    | 47  |      |    |    |     |      |    |    |
| 16  |      |    |    | 32  |      |    |    | 48  |      |    |    |     |      |    |    |

1 Node 2 Common 3 4 5 6 7 8 9 0

Press the F2 Key to return to the common link parameters display.

- Press the End Key from the data link table display (common link parameters or refresh parameters) to bring up the online SYSMAC LINK Data Link Table Menu.

#1 Stopped    Display    Refresh para

[Node addr= 1 ]  
 PC=[ C1000H] 1stRefreshWd=[ LR 00] [ DM 0000] 1stStatusWd=[ DM 0200]

| No. | Node | LR | DM | No. | Node | LR | DM |
|-----|------|----|----|-----|------|----|----|
| 1   | 1    | 1  | 1  | 17  |      |    |    |
| 2   | 2    | 1  | 1  | 18  |      |    |    |
| 3   |      |    |    | 19  |      |    |    |
| 4   |      |    |    | 20  |      |    |    |
| 5   |      |    |    | 21  |      |    |    |
| 6   |      |    |    | 22  |      |    |    |
| 7   |      |    |    | 23  |      |    |    |
| 8   |      |    |    | 24  |      |    |    |
| 9   |      |    |    | 25  |      |    |    |
| 10  |      |    |    | 26  |      |    |    |
| 11  |      |    |    | 27  |      |    |    |
| 12  |      |    |    | 28  |      |    |    |
| 13  |      |    |    | 29  |      |    |    |
| 14  |      |    |    | 30  |      |    |    |
| 15  |      |    |    | 31  |      |    |    |
| 16  |      |    |    | 32  |      |    |    |

[ SYSMAC LINK ] de LR DM

T: Transfer data link table

D: Delete data link table

S: Save data link table

L: Retrieve data link table

R: Start/Stop data link

M: Mon status

N: Read node status

P: Set network parameter

|  |  |  |  |    |  |  |  |    |  |  |  |
|--|--|--|--|----|--|--|--|----|--|--|--|
|  |  |  |  | 41 |  |  |  | 57 |  |  |  |
|  |  |  |  | 42 |  |  |  | 58 |  |  |  |
|  |  |  |  | 43 |  |  |  | 59 |  |  |  |
|  |  |  |  | 44 |  |  |  | 60 |  |  |  |
|  |  |  |  | 45 |  |  |  | 61 |  |  |  |
|  |  |  |  | 46 |  |  |  | 62 |  |  |  |
|  |  |  |  | 47 |  |  |  |    |  |  |  |
|  |  |  |  | 48 |  |  |  |    |  |  |  |

1 Node 2 Common 3 4 5 6 7 8 9 0

- Select the desired operation.

### 15-3-1 Retrieving Data Link Tables

This operation retrieves and displays a data link table from a data disk. The data disk must be formatted with the MS-DOS format.

The data link table being displayed when this operation is executed will be overwritten. Be sure to save the current data link table to disk if it is needed.

- 1, 2, 3... 1. Select "L:Retrieve data link table" from the SYSMAC LINK Data Link Table Menu.
  2. Input the name of the file to be retrieved and press Enter. The specified data link table will be retrieved.
- A directory of the files on the disk can be displayed by pressing End while the file name input area is displayed. A file can then be selected from the directory.

### 15-3-2 Transferring Data Link Tables

These 3 operations are used to transfer a SYSMAC LINK data link table between the computer and a specified PC or to compare the SYSMAC LINK data link tables in the computer and a specified PC.

The following table shows the operations in the Transfer Data Link Table Menu and the data link status in which the operations are allowed.

| Operation              | Function  | Data link status |           |
|------------------------|---|------------------|-----------|
|                        |   | Stopped          | Operating |
| SYSMAC LINK → Computer | Reads the data link table from the PC.                        | OK               | OK        |
| Computer → SYSMAC LINK | Writes the data link table from the SSS to the PC.            | OK               | NO        |
| Verify                 | Compares the data link table in the SSS to the one in the PC. | OK               | OK        |

To display the Transfer Data Link Table Menu, select "T:Transfer data link table" from the SYSMAC LINK Data Link Table Menu.

The screenshot shows a terminal window with the following content:

```

[Node addr= 1 1]
PC=[ C1000H] 1stRefreshWd=[ LR 00] [ DM 0000] 1stStatusWd=[ DM 0200]

```

| No. | Node | LR | DM | No. | Node | LR | DM |
|-----|------|----|----|-----|------|----|----|
| 1   | 1    | 1  | 1  | 17  |      |    |    |
| 2   | 2    | 1  | 1  | 18  |      |    |    |
| 3   |      |    |    | 19  |      |    |    |
| 4   |      |    |    | 20  |      |    |    |
| 5   |      |    |    | 21  |      |    |    |
| 6   |      |    |    | 22  |      |    |    |
| 7   |      |    |    | 23  |      |    |    |
| 8   |      |    |    | 24  |      |    |    |
| 9   |      |    |    | 25  |      |    |    |
| 10  |      |    |    | 26  |      |    |    |
| 11  |      |    |    | 27  |      |    |    |
| 12  |      |    |    | 28  |      |    |    |
| 13  |      |    |    | 29  |      |    |    |
| 14  |      |    |    | 30  |      |    |    |
| 15  |      |    |    | 31  |      |    |    |
| 16  |      |    |    | 32  |      |    |    |

Transfer Data Link Table Menu:

```

[ Transfer Data Link Table ]
[R:SYSMAC LINK -> Computer]
[W:Computer -> SYSMAC LINK]
[V:Veri]

N:Read node status
P:Set network parameter

```

Bottom status bar: 1 Node 2 Common 3 4 5 6 7 8 9 0

#### Transferring to the Computer

The SYSMAC LINK → Computer operation reads specified nodes' data link tables (common link parameters and refresh parameters). Transfer the data link tables to the computer when checking or editing a node's data link table. When editing the data link tables, save the tables to disk and edit the tables offline.

When the tables are transferred, the data link table currently displayed at the SSS will be deleted. Be sure to save the current tables to disk if they are needed.

- 1, 2, 3... 1. Select "R:SYSMAC LINK → Computer" from the Transfer Data Link Table Menu.

- Input the node number to specify which node's common link parameters will be transferred to the computer. The following display will appear after the common link parameters have been read.

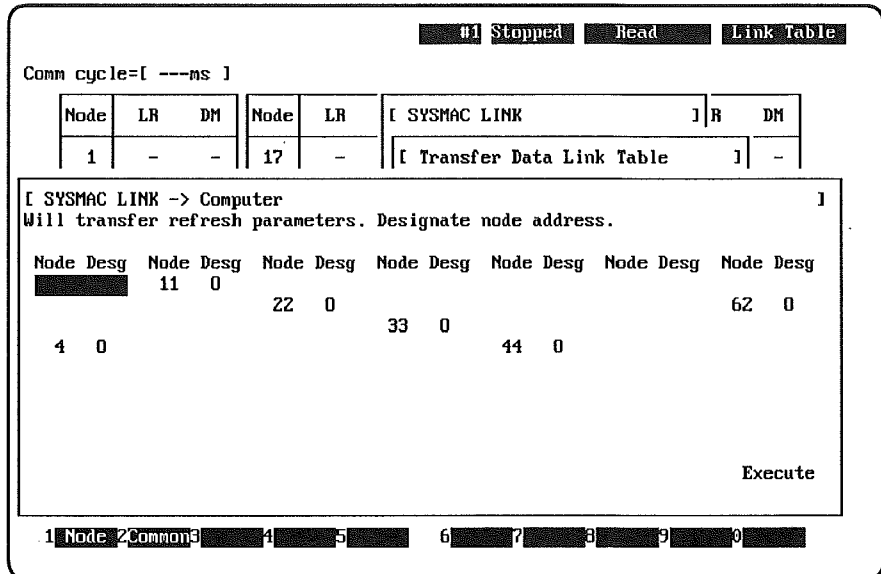

The node numbers of all of the nodes in the network will be displayed. Circles will be displayed next to the nodes from which refresh parameters will be read. (Initially, circles are displayed next to all of the nodes in the data link.)

- To change a node's transfer status, move the cursor to node and press Enter to add or remove the circle indicating its refresh parameters will be read.
- To transfer the parameters, move the cursor to "Execute" in the lower-right corner of the display and press Enter. The results will be displayed when the transfer is completed.

### Transferring to the PC

The Computer → SYSMAC LINK operation writes the data link tables (common link parameters and refresh parameters) from the SSS to the specified PCs. The data link tables in the specified PCs will be overwritten, so be sure to save any node's data link table to disk if it is needed before executing the transfer.

To transfer data link tables from a data disk, first retrieve the tables to the SSS and then transfer them to the PCs.

- 1, 2, 3... 1. Select "W:Computer → SYSMAC LINK" from the Transfer Data Link Table Menu. The following display will appear.

#1 Stopped
Write
Link Table

Comm cycle=[ ---ms ]

| Node | LR | DM | Node | LR | [ SYSMAC LINK ]              | R | DM |
|------|----|----|------|----|------------------------------|---|----|
| 1    | 1  | 1  | 17   | -  | [ Transfer Data Link Table ] |   | -  |

[ Computer → SYSMAC LINK ]

Will transfer data link table. Designate node address.

| Node | Desg | Node | Desg | Node | Desg | Node | Desg |
|------|------|------|------|------|------|------|------|
| 11   | 0    | 22   | 0    | 33   | 0    | 44   | 0    |
| 4    | 0    |      |      |      |      |      |      |

Execute

1 Node
2 Common
3
4
5
6
7
8
9
0

Circles will be displayed next to the nodes to which the data link tables will be written. Initially, circles are displayed next to all of the nodes set in the data link offline.

2. To change a node's transfer status, move the cursor to node and press Enter to add or remove the circle.
3. To transfer the data link tables, move the cursor to "Execute" in the lower-right corner of the display and press Enter. The results will be displayed when the transfer is completed.

#0 Stopped
Write
Link Table

|                  |                  |                  |
|------------------|------------------|------------------|
| Node Exec Result | Node Exec Result | Node Exec Result |
| 2 Okay           |                  |                  |
| 3 Okay           |                  |                  |
| 4 Okay           |                  |                  |
| 5 Okay           |                  |                  |

End

### Comparing Data Link Tables

The Verify operation compares the data link table in the computer to the data link tables in the specified PCs. This operation is normally used after transferring data link tables to or from the computer to be sure the transfer operation was successful. If the data link tables don't agree, execute the transfer operation again.

- 1, 2, 3... 1. Select "V:Veri" from the Transfer Data Link Table Menu. The following display will appear.

#1 Stopped   
 Verify   
 Link Table

Comm cycle=[ ---ms ]

|      |    |    |      |    |                            |     |    |
|------|----|----|------|----|----------------------------|-----|----|
| Node | LR | DM | Node | LR | [ SYSMAC LINK              | ] R | DM |
| 1    | -  | -  | 17   | -  | [ Transfer Data Link Table | ] - | -  |

[ Node Designation ]  
 Will verify data link table. Designate node address.

|  |           |           |           |           |           |           |
|--|-----------|-----------|-----------|-----------|-----------|-----------|
| Node Desg  | Node Desg | Node Desg | Node Desg | Node Desg | Node Desg | Node Desg |
| <span style="background-color: black; color: black;">████████</span> | 11 0      | 22 0      | 33 0      | 44 0      | 62 0      |           |
| 4 0  |           |           |           |           |           |           |

Execute

1 Node
2 Common
3
4
5
6
7
8
9
0

Circles will be displayed next to the nodes with which the data link tables will be compared. Initially, circles are displayed next to all of the nodes set in the data link offline.

2. To change a node's comparison status, move the cursor to node and press Enter to add or remove the circle.
3. To compare the data link tables, move the cursor to "Execute" in the lower-right corner of the display and press Enter. The results will be displayed when the comparison is completed.

#1 Stopped   
 Verify   
 Link Table

|                  |                  |                  |
|------------------|------------------|------------------|
| Node Exec Result | Node Exec Result | Node Exec Result |
| 4 Ver error      |                  |                  |
| 11 Ver error     |                  |                  |
| 22 Ver error     |                  |                  |
| 33 Ver error     |                  |                  |
| 44 Ver error     |                  |                  |
| 62 Ver error     |                  |                  |

Will display unmatched contents. Input node number 4

4. If "Comparison error" is displayed for a node, details about the differences in the data link tables can be displayed by entering that node's node number. The com-



puter's parameter is displayed on the top row and the PC's is displayed on the bottom.

#0 Stopped   Verify   Link Table

Node: 1

Upper:Comp/Lower:SYSMAC LINK

|                      |                    |
|----------------------|--------------------|
| No. of refresh nodes | 4<br>5             |
| Comm cycle time      |                    |
| First status word    | HR 00<br>DM 0200   |
| First LR word        | LR 10<br>LR 00     |
| First DM word        | DM 0050<br>DM 0000 |

- If there are differences in the common link parameters, "Continued" will be displayed at the bottom of the screen. Press the PageDown Key to display those differences.

#0 Stopped   Verify   Common param

Node: 5

Upper:Comp/Lower:SYSMAC LINK

| Node | LR | DM | Node | LR | DM | Node | LR | DM | Node | LR | DM |
|------|----|----|------|----|----|------|----|----|------|----|----|
| 1    | 1  | 1  |      |    |    |      |    |    |      |    |    |
|      | 2  | 2  |      |    |    |      |    |    |      |    |    |
| 2    | 1  | 1  |      |    |    |      |    |    |      |    |    |
|      | 2  | 2  |      |    |    |      |    |    |      |    |    |
| 3    | -  | -  |      |    |    |      |    |    |      |    |    |
|      | 2  | 2  |      |    |    |      |    |    |      |    |    |
| 4    | -  | -  |      |    |    |      |    |    |      |    |    |
|      | 2  | 2  |      |    |    |      |    |    |      |    |    |
| 5    | 10 | 10 |      |    |    |      |    |    |      |    |    |
|      | 2  | 2  |      |    |    |      |    |    |      |    |    |
| 10   | 50 | 50 |      |    |    |      |    |    |      |    |    |
|      | -  | -  |      |    |    |      |    |    |      |    |    |
| 15   | 0  | 0  |      |    |    |      |    |    |      |    |    |
|      | -  | -  |      |    |    |      |    |    |      |    |    |
| 31   | -  | -  |      |    |    |      |    |    |      |    |    |
|      | 2  | 2  |      |    |    |      |    |    |      |    |    |

Continued

- Press the PageDown Key again. If there are differences in the refresh parameters, they will be displayed as in the following example.

| Node: 5 |      |    |    | #0                           | Stopped | Verify | Refresh para |
|---------|------|----|----|------------------------------|---------|--------|--------------|
|         |      |    |    | Upper:Comp/Lower:SYSMAC LINK |         |        |              |
| No.     | Node | LR | DM | No.                          | Node    | LR     | DM           |
| 1       | 1    | 1  | 1  |                              |         |        |              |
|         | 2    | 2  | 2  |                              |         |        |              |
| 2       | 2    | 1  | 1  |                              |         |        |              |
|         | 3    | 2  | 2  |                              |         |        |              |
| 3       | 5    | 10 | 10 |                              |         |        |              |
|         | 4    | 2  | 2  |                              |         |        |              |
| 4       | 10   | 50 | 50 |                              |         |        |              |
|         | 5    | 2  | 2  |                              |         |        |              |

- If there are comparison errors in other nodes, press the Escape Key to return to the comparison results display. Enter the node number of another node to display its differences. To return to the data link display, press Ctrl+\.
- When differences are detected in the data link tables, transfer the tables again with the SYSMAC LINK → Computer or Computer → SYSMAC LINK operation.

### 15-3-3 Deleting Data Link Tables

This operation deletes the SYSMAC LINK data link tables from the specified PCs. Delete a PC's data link tables when data link tables have been transferred to the PC from the computer but differences were detected by the comparison operation.

The data link tables can't be deleted while the data link is operating.

- 1, 2, 3... 1. Select "D:Delete data link table" from the SYSMAC LINK Data Link Table Menu. The following display will appear.

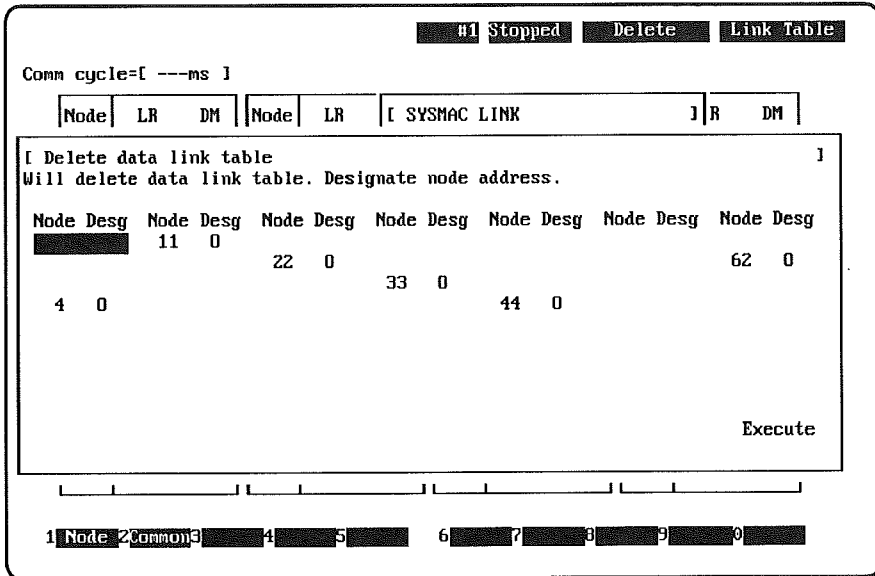

Circles will be displayed next to the nodes from which the data link tables will be deleted. Initially, circles are displayed next to all of the nodes that are not set in the data link offline.

- To change a node's deletion status, move the cursor to node and press Enter to add or remove the circle.
- To delete the data link tables, move the cursor to "Execute" in the lower-right corner of the display and press Enter. The results will be displayed when the operation is completed.

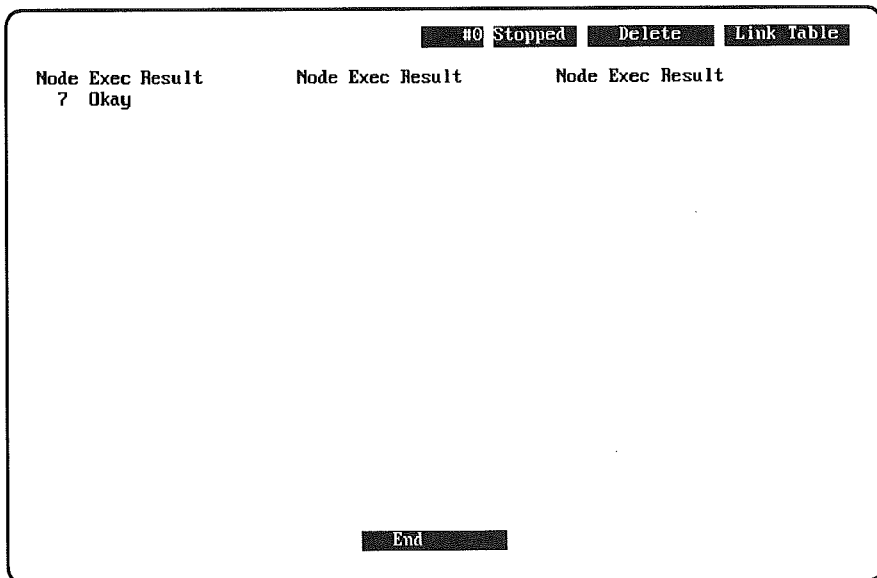

### 15-3-4 Saving Data Link Tables

This operation saves the currently displayed data link table to a disk. Use a data disk formatted with the MS-DOS format.

- 1, 2, 3... 1. Select "S:Save data link table" from the SYSMAC LINK Data Link Table Menu.
2. Input the name of the file and press Enter or display a directory of the files on the disk by pressing End and select a file from the directory.

### 15-3-5 Starting and Stopping the Data Link

This operation starts or stops the data link for the specified node. The data link can also be started with the switch on the front of each SYSMAC LINK Unit, but this method is effective only when the power is turned on. The SSS can be used to start or stop the data link at any time, regardless of the data link start/stop setting on the SYSMAC LINK Unit.

- 1, 2, 3... 1. Select "R:Start/Stop data link" from the SYSMAC LINK Data Link Table Menu.

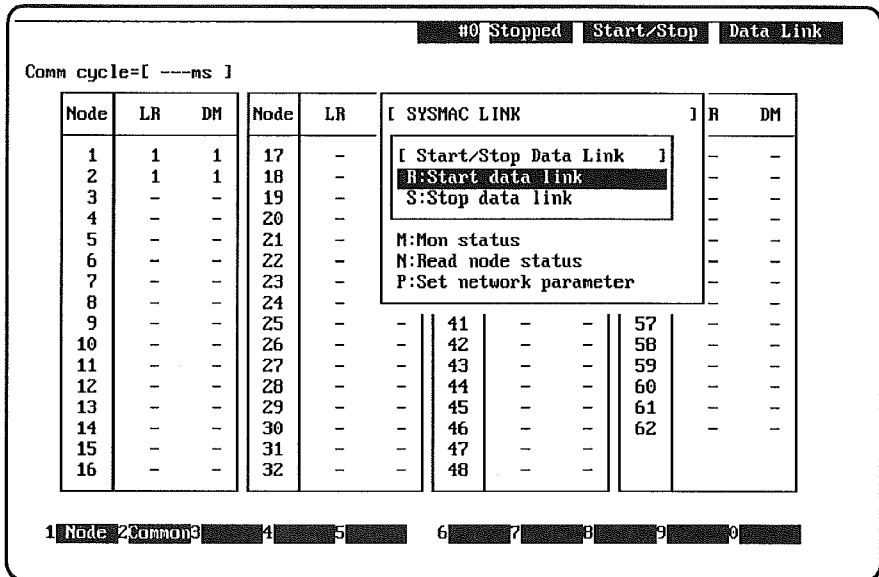

2. Select "R:Start data link" to start the data link or "S:Stop data link" to stop the data link.
3. Input the node number of the node where the data link is to be started or stopped. Any node that is in the data link and has a data link table can be specified.

### 15-3-6 Monitoring the Data Link

These 3 operations are used to monitor and display information about the operating status of the data link. The following table shows the operations in the Data Link Monitor Menu and the data link status in which the operations are allowed.

| Operation                    | Function   | Data link status |           |
|------------------------------|--|------------------|-----------|
|                              |  | Stopped          | Operating |
| Monitor data link status     | Displays the operating status of nodes participating in the data link.   | No               | OK        |
| Monitor communications cycle | Measures and displays the SYSMAC LINK network's communications cycle time.   | OK               | OK        |
| Monitor refresh cycle        | Measures and displays the refresh cycle time of the specified node.<br>Refer to the Unit's Operation Manual for details on the refresh cycle time. | No               | OK        |

To display the Data Link Monitor Menu, select "M:Mon status" from the SYSMAC LINK Data Link Table Menu.

#0 Stopped Status montr

Comm cycle=[ ---ms ]

| Node | LR | DM | Node | LR | [ SYSMAC LINK ]              | R | DM |
|------|----|----|------|----|------------------------------|---|----|
| 1    | 1  | 1  | 17   | -  | [ Monitor Status ]           | - | -  |
| 2    | 1  | 1  | 18   | -  | D:Data link status monitor   | - | -  |
| 3    | -  | -  | 19   | -  | F:Comm cycle time monitor    | - | -  |
| 4    | -  | -  | 20   | -  | R:Refresh cycle time monitor | - | -  |
| 5    | -  | -  | 21   | -  |                              | - | -  |
| 6    | -  | -  | 22   | -  | N:Read node status           | - | -  |
| 7    | -  | -  | 23   | -  | P:Set network parameter      | - | -  |
| 8    | -  | -  | 24   | -  |                              | - | -  |
| 9    | -  | -  | 25   | -  |                              | - | -  |
| 10   | -  | -  | 26   | -  | 41                           | - | 57 |
| 11   | -  | -  | 27   | -  | 42                           | - | 58 |
| 12   | -  | -  | 28   | -  | 43                           | - | 59 |
| 13   | -  | -  | 29   | -  | 44                           | - | 60 |
| 14   | -  | -  | 30   | -  | 45                           | - | 61 |
| 15   | -  | -  | 31   | -  | 46                           | - | 62 |
| 16   | -  | -  | 32   | -  | 47                           | - | -  |
|      |    |    |      |    | 48                           | - | -  |

1 Node 2 Common 3 4 5 6 7 8 9 0

### Monitoring Data Link Status

The "Monitor data link status" operation displays the operating status of the nodes participating in the data link. This operation cannot be performed if the data link is stopped.

- 1, 2, 3...
1. Select "D:Data link status monitor" from the Data Link Monitor Menu.
  2. Input the node number of a node in the data link. The data link status of nodes participating in the data link will be displayed.

#1 Operating DataLnkStat Status montr

[ Node addr= 44 ]

| Node Addr | PC Run | PC Error | Comm Error | Oper | Node Addr | PC Run | PC Error | Comm Error | Oper |
|-----------|--------|----------|------------|------|-----------|--------|----------|------------|------|
| 4         |        |          |            | 0    | 22        | 0      |          |            | 0    |
| 11        | 0      |          |            | 0    |           |        |          |            |      |

Press the PageDown Key to display node number 33 to 62. The following items are monitored:

| Item      | Status   |
|-----------|--|
| PC Run    | A circle indicates that the PC is in RUN or MONITOR mode.                    |
| PC Err    | A circle indicates that a fatal error has occurred at the PC.                |
| Com Err   | A circle indicates that the node isn't able to participate in the data link. |
| Link Acti | A circle indicates that the data link is operating normally.                 |

**Monitoring the Communications Cycle Time**

The "Monitor communications cycle" operation measures and displays the SYSMAC LINK network's communications cycle time. This operation can be performed even if the data link is stopped.

To execute the operation, select "T:Comm cycle time monitor" from the Data Link Monitor Menu. A display showing the current and maximum cycle time will be displayed.

#1 Stopped
Comm cycle
Status monitr

Comm cycle=[ ---ms ]

| Node | LR | DM | Node | LR | [ SYSMAC LINK ]             | R | DM |
|------|----|----|------|----|-----------------------------|---|----|
| 1    | 1  | 1  | 17   | -  | [ Monitor Status ]          | - | -  |
| 2    | 1  | 1  | 18   | -  | [ Comm Cycle Time Monitor ] | - | -  |
| 3    | -  | -  | 19   | -  | Max.: 7.7 ms                | - | -  |
| 4    | -  | -  | 20   | -  | Current: 4.3 ms             | - | -  |
| 5    | -  | -  | 21   | -  | P:Set network parameter     | - | -  |
| 6    | -  | -  | 22   | -  |                             | - | -  |
| 7    | -  | -  | 23   | -  |                             | - | -  |
| 8    | -  | -  | 24   | -  |                             | - | -  |
| 9    | -  | -  | 25   | -  |                             | - | -  |
| 10   | -  | -  | 26   | -  | 41                          | - | 57 |
| 11   | -  | -  | 27   | -  | 42                          | - | 58 |
| 12   | -  | -  | 28   | -  | 43                          | - | 59 |
| 13   | -  | -  | 29   | -  | 44                          | - | 60 |
| 14   | -  | -  | 30   | -  | 45                          | - | 61 |
| 15   | -  | -  | 31   | -  | 46                          | - | 62 |
| 16   | -  | -  | 32   | -  | 47                          | - | -  |
|      |    |    |      |    | 48                          | - | -  |

1 Node
2 Common
3
4
5
6
7
8
9
0

**Monitoring the Refresh Cycle Time**

The "Monitor refresh cycle" operation measures and displays the specified node's refresh cycle time, i.e., the time required to refresh the node's SYSMAC LINK data link area. This operation cannot be performed if the data link is stopped.

- 1, 2, 3... 1. Select "R:Refresh cycle time monitor" from the Data Link Monitor Menu.

- Input the node number of a node in the data link. The model of the PC, the current refresh cycle time, and the maximum refresh cycle time will be displayed.

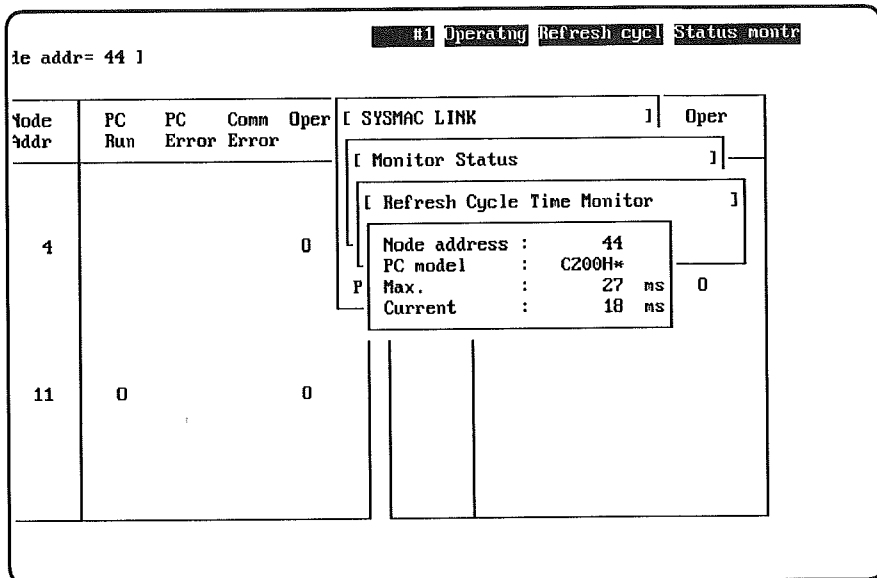

**Note** The PC model will show "C200H\*" for C200HS and C200HX/HG/HE PCs.

### 15-3-7 Displaying a Node's Error Status

The "Read node status" operation lists errors that have occurred in the specified node.

- Select "N:Read node status" from the SYSMAC LINK Data Link Table Menu.
- Input the node number of a node in the data link. A dash in the list indicates normal operation and a circle indicates that an error has occurred.

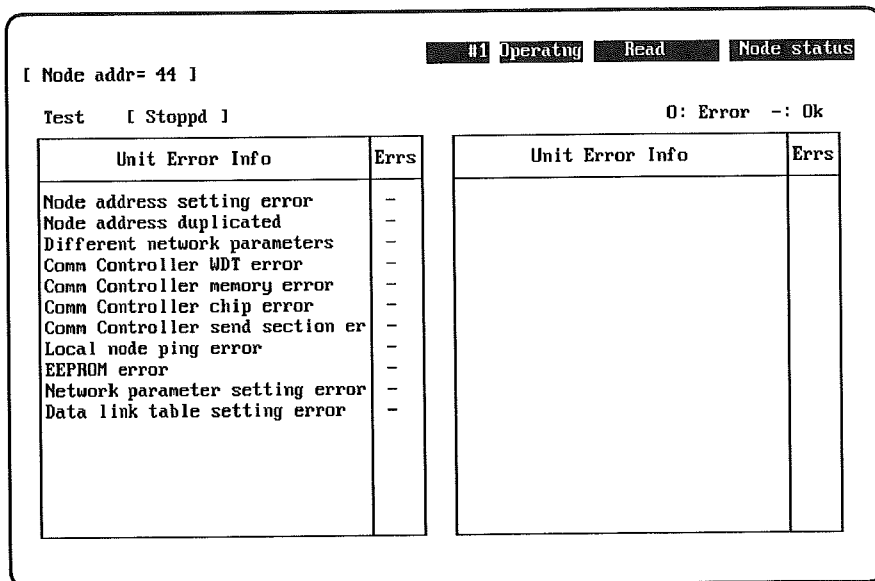

The following table shows the error messages that might be displayed.

| Error message                      | Probable cause  | Remedy  |
|------------------------------------|---|---|
| Node address setting error         | The node number is not in the range 1 to 62.  | Set the node number within the range 1 to 62.   |
| Node address duplicated            | A node number has been used more than once.   | Change the node number so that each number is unique.   |
| Different network parameters       | The previously set network parameters don't match the current operating network parameters. | Check the current network parameters and change as needed.  |
| Comm controller WDT error          | A watchdog timer error occurred in the communications controller.                           | Noise might have affected communications. Check the operating environment.  |
| Comm Controller memory error       | A memory error occurred in the communications controller.                                   | A hardware error has occurred. Replace the Unit.  |
| Comm Controller chip error         | An operating error occurred in the communications controller.                               |   |
| Comm Controller send section error | An error occurred in the communications controller's transmitter.                           |   |
| Local node ping error              | An error occurred in the communications controller's transmission or reception              |   |
| EEPROM error                       | The network parameters or data link table stored in EEPROM have been corrupted.             | Write the network parameters and data link table again.<br>Replace the Unit if the error occurs again; there might be a hardware error.                 |
| Network parameter setting error    | The network parameters stored in EEPROM have been corrupted.                                | Write the network parameters again.<br>Replace the Unit if the error occurs again; there might be a hardware error.                                     |
| Data link table setting error      | The data link table hasn't been set correctly.  | Check the data link table settings and write the data link table again.<br>Replace the Unit if the error occurs again; there might be a hardware error. |

### 15-3-8 Setting the Network Parameters

This operation is used to set the maximum node number in the network—reducing the cycle time; it can be executed only when the data link is stopped. Set the maximum node number when you want to reduce the communications cycle time.

This operation is effective when the data link area is set automatically by the SYSMAC LINK Unit. Refer to the SYSMAC LINK Unit's Operation Manual for details on how much the communications cycle time can be reduced.



- 1, 2, 3... 1. Select "P:Set network parameter" from the SYSMAC LINK Data Link Table Menu.

#0 Stopped   Set   Net param

Comm cycle=[ ---ms ]

| Node | LR | DM | Node | LR | [ SYSMAC LINK ]           | R | DM |
|------|----|----|------|----|---------------------------|---|----|
| 1    | 1  | 1  | 17   | -  | [ Set Network Parameter ] |   | -  |
| 2    | 1  | 1  | 18   | -  | Max. node address: 62     |   | -  |
| 3    | -  | -  | 19   | -  |                           |   | -  |
| 4    | -  | -  | 20   | -  | R:Start/Stop data link    |   | -  |
| 5    | -  | -  | 21   | -  | M:Mon status              |   | -  |
| 6    | -  | -  | 22   | -  | N:Read node status        |   | -  |
| 7    | -  | -  | 23   | -  | P:Set network parameter   |   | -  |
| 8    | -  | -  | 24   | -  |                           |   | -  |
| 9    | -  | -  | 25   | -  | 41                        | - | 57 |
| 10   | -  | -  | 26   | -  | 42                        | - | 58 |
| 11   | -  | -  | 27   | -  | 43                        | - | 59 |
| 12   | -  | -  | 28   | -  | 44                        | - | 60 |
| 13   | -  | -  | 29   | -  | 45                        | - | 61 |
| 14   | -  | -  | 30   | -  | 46                        | - | 62 |
| 15   | -  | -  | 31   | -  | 47                        | - |    |
| 16   | -  | -  | 32   | -  | 48                        | - |    |

1 Node 2 Common 3 4 5 6 7 8 9 0

2. Input the maximum node number of the nodes in the data link. The setting range is 2 to 62.



# Part 5

# Appendices

This part of the manual provides lists of error messages, offline operations, and online operations.



## Appendix A

### Error Messages

If an error occurs during SSS execution, an error message will be displayed on the upper left or the lower part of the screen. The following table lists the error messages that may be displayed. By referring to this table, corrective action can be taken to correct an error. Refer also to other sections of the manual for error messages that appear for specific operations only, such as those given in *Part 4 Networks*.

| Error   | Cause   | Corrective action  |
|---|---|--|
| Address overflow  | An address exceeding the last address of the user program has been specified.                   | Specify the correct address.   |
| Area exceeded   | The I/O table cannot be transferred because the unused area in the user memory is insufficient. | Separately save and transfer the program and I/O table.  |
|   | The DM area is exceeded.  | Observe the range of the DM area.  |
| Bat err   | The battery is not connected. The PC battery is low.  | Check the connection of the battery. Replace the battery with a new one.   |
| Cannot  | The cause of the error has not been identified  | Check the system.  |
| Cannot convert  | C500's instructions cannot be converted into C2000H format.                                     | Check the program. Specify C2000H as the PC model (for C200H, C1000H, and C2000H), and set the data disk for C500 (for C500, C120, C20, P-type PCs) in the data drive. |
| Cannot cancel   | The effect of the forced-set or reset cannot be canceled.                                       | Check the PC and Host Link Unit.   |
| Cannot chg now  | The current value cannot be changed during a forced-set or reset.                               | Cancel the forced-set or reset.  |
| Cannot clear  | While the file memory was being cleared, a protected block was found.                           | Cancel the protection.   |
| Cannot execute  | The memory failed or the setting is wrong.  | Check the available capacity of the memory of the PC, computer, and File Memory Unit. Check the set value and file name.   |
| Cannot read   | A memory other than the file memory's END block of user memory exists.                          | Check the File Memory.   |
| Cannot start due to insufficient memory. Processing interrupted. Press any key to continue. | There is insufficient memory capacity.  | Check the available memory capacity, and check the contents of CONFIG.SYS.   |
| Cannot verify   | A memory other than the file memory's END block of user memory exists.                          | Check the File Memory.   |
| Cannot w/PC running   | The PC is in the MONITOR or RUN mode.   | Set to the PROGRAM mode.   |
| Cannot with a ROM   | A ROM Unit is mounted on the PC. Or, the write protect switch of the RAM Unit on the PC is ON.  | Use the RAM Unit, or turn OFF the protect switch of the RAM Unit.  |
| Cannot write  | The data of the data link table is not on the system work disk.                                 | Store the data in the system work disk.  |
|   | The I/O table cannot be written to a C200H.   | Create the I/O table.  |
| Comment overflow  | The maximum number of I/O comments is 3,500 including points and words.                         | Delete unnecessary comments.   |

| Error                | Cause   | Corrective action   |
|----------------------|---|---|
| Communication error  | Communications problem  | Check the cable, SYSMAC NET Link Units, Host Link Units, and PC. Check the System Setup.  |
|                      | Monitoring has been aborted because a communications problem occurred.  | Remove the source of the problem.   |
| Conversion error     | Data that cannot be converted has been found in the program of the PC.  | Check the program of the PC.  |
| Dev error            | The File Memory Unit is not mounted to the connected PC, or the File Memory Unit failed. The program was transferred and exceeds the user memory area of the PC.  | Check the PC. Check the size of the program.  |
| Display exceeded     | The display range is exceeded. No more data can be displayed using the Cursor Keys.   | Display the preceding screen or the next screen by using the PageDown or PageUp key.  |
| DOS message          | An error occurred in DOS while the disk was being accessed.   | Write-enable the floppy disk, input A, and start the SSS again.   |
| Dpl error            | An error occurred during duplex operation.  | Correctly perform the setting for duplex operation.   |
| Error                | An error has occurred during a file memory operation. The specified file cannot be created and transferred from the computer to the data disk.  | Check the File Memory Unit. Check the floppy disk.  |
|                      | The PC program is different from the SSS program.   | Transfer the program.   |
| First screen         | There is no preceding screen.   | ---   |
| FALS error           | A FALS** instruction has been executed. The FALS9F instruction is executed when the watchdog timer measures 120 to 130 ms which causes the execution to be stopped.   | Check the program.  |
| FAT has been lost    | The floppy disk is faulty.  | Replace the floppy disk.  |
| File full            | The number of files in the data disk has exceeded 255.  | Use another floppy or delete unnecessary files.   |
| Host Link mode error | The Host Link Unit is in the wrong mode (host mode or local mode).  | Set the Host Link Unit in the correct mode.   |
| Insert a floppy      | A floppy disk is not set.   | Set the floppy disk.  |
| I/O bus error        | An error occurred in the bus between the CPU and I/O Units.   | Check the bus line between the CPU and I/O Unit. Check whether the cable of each I/O Unit is correctly connected. Clear the error after the corrective action has been taken. |
| I/O tbl ver err      | The registered I/O table does not match the conditions of the mounted I/O. Probably are some I/O Units are not mounted.   | Verify the I/O table, correct the setting of the I/O Units, and create the I/O table.   |
| I/O unit error       | The registered I/O table does not match the conditions of the mounted I/O. The possible causes are mismatching of the number of input and output points, illegal use of Remote I/O Slave Units, or duplication word allocations for Optical I/O Units or I/O Terminals. | Verify the I/O table, correct the setting of the I/O Units, and create the I/O table.   |
| Ladder error         | The ladder diagram cannot be converted into mnemonic. When the program is read in the ladder diagram mode, it cannot be converted into a ladder diagram.  | Check the ladder diagram. Check the mnemonics.  |

| Error              | Cause   | Corrective action  |
|--------------------|---|--|
| Last screen        | There is no next screen.  | Display the preceding screen by using the PageUp key.  |
| Mem err            | An error exists in the user program. An instruction corresponding to <????> exists in the user program.   | Check whether the ROM or RAM Unit is correctly mounted on the PC. Check the program.               |
| Memory erased      | The data in the system work disk of the computer has been destroyed.  | Install the SSS again.   |
| Memory exceeded    | The programming area of the computer is incorrect.  | Check the program.   |
| Monitor reg over   | More than 128 bits or words have been specified for monitoring.   | Reduce the amount of data to be monitored, or check the monitored program.                         |
| Need an END        | The END instruction is missing from the program.  | Write the END instruction at the end of the program.   |
| No DM in a C20     | The C20 does not contain a DM area.   | Specify a PC with a DM area.   |
| No END block       | The END block is missing from the File Memory.  | Display the directory to check the File Memory.  |
| No file memory     | The File Memory Unit is not mounted on the PC.  | Mount the File Memory Unit.  |
| No room            | No unused area is available on the data disk.   | Delete an unnecessary file, or use a new disk.   |
| No room in disk    | There isn't enough free space available to start the DM editing function.   | Provide enough free space on the disk.   |
| No room in DM      | The DM area is too small to handle the data when retrieving DM data and appending existing data.  | Check the size of the DM area in the destination node.   |
| No such comment    | The specified I/O comment has not been created in the I/O comment area.   | Specify the correct I/O comment.   |
| No such program    | The instruction block displayed in the ladder diagram mode does not exist at the specified address. The specified instruction was not found before the END instruction was reached. | Check the program.   |
| Not w/PC connected | The operation is not possible while the PC is online.   | Switch to offline operations.  |
| PC link com error  | An error occurred during transmission of the PC Link Unit.  | Check the transmission line of the PC Link Unit (refer to the Operation Manual of the Unit).       |
| Printer not ready  | A printer is not connected to the computer.   | Press ESC and connect the printer.   |
| Program overflow   | If the specified program is written or inserted, the capacity of the user program memory will be exceeded.  | Delete an unnecessary program.   |
| Protected          | The File Memory is protected.   | Cancel the protection.   |
| Remote I/O error   | A transmission error has occurred between the Remote I/O and PC.  | Check the transmission line between the PC and Remote I/O. Check whether the Slave Rack is normal. |
| Cycle time over    | The monitor cycle time (default: 100 ms) has been executed in program execution (program too long).   | Check the program.   |
| Set error          | Wrong operation   | Check the numeric value, mode, and keys.   |
|                    | Wrong key input   | Input the correct data.  |
| Sorry, no file     | The specified file number or name does not exist on the data disk.  | Check the file name and data disk.   |

| Error              | Cause   | Corrective action   |
|--------------------|---|---|
| SV error           | The input value exceeds the limit of the PC.  | Input the correct data.   |
| Too many blocks    | All the data could not be transferred because the capacity of the File Memory has run short.  | Delete unnecessary blocks.  |
| Too many I/O units | The number of I/O points and Remote I/O points of the registered I/O table exceeds the limit. | Read the I/O table, correct the setting of the I/O Units, and create a new I/O table  |
| Ver err            | The SSS system work disk data does not match the ROM Writer data.                             | Check the data of the SSS or PROM Writer.   |
| Verification error | The PC program does not match the SSS program.  | Transfer the program.   |
| Write-protected    | The data disk is write-protected.   | Disable the disk write protection.  |
| Wrong data disk    | The floppy disk in the data drive cannot be used as a data disk.                              | Check if the disk in the data drive is appropriate for the PC model currently specified (i.e., whether the disk is for C2000H or C500). |
|                    | The floppy disk is faulty or the data in the disk has been destroyed.                         | Try again. If an error still occurs, replace the floppy disk.   |
| Wrong data area    | The position specified for copy, move, or delete is wrong.                                    | Check the operation and program.  |
| Wrong path         | The drive is not FDD or HDD, or the specified drive does not exist.                           | Check if the drive is FDD/HDD. Set the data drive correctly.  |
| Wrong edit mode    | A wrong edit mode (read, write, insert, delete, store, store/delete) has been specified.      | Change the edit mode. Check the setting of OUT Bit Comment in the System Setup.   |
| Wrong file         | A wrong file name has been input.   | Input the correct file name.  |
| Wrong floppy       | The specified size of the floppy disk is different from the size of the actual disk.          | Specify the correct size.   |
| Wrong key          | The wrong type of data (data area, constant, bit/word) has been input.                        | Input the correct data.   |
| Wrong media        | Data disk is not reading and writing correctly.   | Check the data disk.  |
| Wrong PC           | A wrong PC model is specified.  | Check the PC and the parameters of the System Setup.  |
| Wrong PC mode      | The PC is in the wrong mode (RUN, MONITOR, PROGRAM).  | Set the PC in the correct mode.   |
| Wrong position     | The specified function cannot be executed because the cursor is at a wrong position.          | Move the cursor to the correct position.  |
| Wrt err            | Data cannot be correctly written to the PROM Writer.  | Check the PROM Writer.  |



## Error Messages Related to Installation

| Error   | Cause  | Corrective action  |
|---|--|--|
| Cannot create file CONFIG.SYS. Verify the number of files in the root directory.          | The number of the files in the root directory is the maximum value that can be managed by DOS, or the capacity of the hard disk is insufficient. | Reduce the number of files in the root directory or increase the capacity of the hard disk (use a larger disk).              |
| Drive specification is wrong.   | A non-existent drive number has been specified.  | Specify the correct drive number.  |
| Insufficient hard disk capacity. Check and verify sufficient capacity, and execute again. | The number of files in the root directory that can be managed by DOS was exceeded when the SSS subdirectory was created in the root directory.   | Increase the capacity of the hard disk. To install the system, 8M bytes of unused disk space is necessary.                   |
| Files required for processing do not exist. Reinstall system.                             | Essential files are missing or damaged.  | Install the system one more time.  |
| No help file.   | A file required to display help cannot be found.   | Reinstall.   |
| Unable to execute function. Insufficient memory area or missing task file. Reinstall.     | The memory area is insufficient, or required file is damaged or missing.   | Provide sufficient memory area and install the system one more time.   |
| Wrong PATH setting. Press any key.  | The setting of the PATH variable in AUTOEXEC.BAT is incorrect.   | Add the PATH name of the directory where the SSS is installed to the PATH setting in AUTOEXEC.BAT (default is C:\SYSTEMATE). |



# Appendix B

## Offline Operations

The following tables list the basic SSS offline operations.

### Programming Menu

| Operation                  | Function  | Page |
|----------------------------|---|------|
| <b>R:Connect line</b>      | Creates connecting lines between programming elements (vertical line, symbols, etc.).               | 30   |
| <b>S:Save program</b>      | Writes the ladder or mnemonic program in the system work area to the data disk.                     | 71   |
| <b>L:Retrieve program</b>  | Reads the ladder or mnemonic program on the data disk to the system work area.                      | 74   |
| <b>H:Change display</b>    | Sets the method for displaying ladder diagrams and mnemonic programs.                               | 56   |
| <b>K:Search</b>            | Searches for instructions through their operands.   | 80   |
| <b>I:I/O comment</b>       | Finds and displays ladder diagrams, by means of writing and specifying I/O comments.                | 87   |
| <b>Y:Instr comment</b>     | Writes comments such as output conditions to output instructions.                                   | 61   |
| <b>G:Block comment</b>     | Writes block comments between instruction blocks.   | 59   |
| <b>E&gt;Edit ladder</b>    | Moves, copies, or deletes instruction blocks for a program in the system work area.                 | 90   |
| <b>N&gt;Edit comments</b>  | Displays I/O comments on the screen 32 at a time, and edits the comments.                           | 93   |
| <b>D:Retrieve comments</b> | Reads I/O comments, instruction comments, and block comments from programs stored on the data disk. | 76   |
| <b>M:Memory usage</b>      | Displays how the memory area is being used in the system work area.                                 | 17   |
| <b>C:Clear memory</b>      | Clears the data in the system work area.  | 12   |
| <b>P:Check program</b>     | Checks whether ladder and mnemonic programs in the system work area are correct.                    | 69   |

### DM Menu

| Operation                 | Function  | Page |
|---------------------------|---|------|
| <b>P:Go to page</b>       | Displays the specified 160-word page of DM data.  | 115  |
| <b>C:Copy</b>             | Copies a specified number of consecutive DM words beginning at the specified DM address.                      | 116  |
| <b>F:Fill</b>             | Places a specified value into a specified number of consecutive DM words beginning at a specified DM address. | 116  |
| <b>P:Print</b>            | Prints the specified block of DM words.   | 117  |
| <b>A:HEX ↔ ASCII</b>      | Sets input to hexadecimal or ASCII. The selected input mode will be displayed in the top-right of the screen. | 114  |
| <b>S:Save DM data</b>     | Saves DM data from the system work area to the data disk.   | 117  |
| <b>L:Retrieve DM data</b> | Retrieves DM data on the data disk to the system work area.   | 119  |

## I/O Table Menu

| Operation                   | Function   | Page |
|-----------------------------|--|------|
| <b>W:Write I/O table</b>    | Used to write and edit the I/O table in the system work area.  | 131  |
| <b>C:Check I/O table</b>    | Checks the contents of the I/O table in the system work area and displays errors if detected.                  | 137  |
| <b>S:Save I/O table</b>     | Saves the I/O table contents in the system work area and the first words set in the PC Setup to the data disk. | 138  |
| <b>L:Retrieve I/O table</b> | Retrieves the I/O table contents from the data disk to the system work area.                                   | 139  |
| <b>P:Print I/O table</b>    | Prints the contents of the I/O table in the system work area.  | 139  |

## Utility Menu

| Operation                 | Function  | Page |
|---------------------------|---|------|
| <b>H:Data area lists</b>  | <b>U:Used data areas</b><br>Lists the data area words and bits that are used in the program and how they are used.  | 146  |
|                           | <b>C:Used areas w/cmnts</b><br>Lists the data area words and bits that are used in the program along with their I/O comments.                                 | 147  |
|                           | <b>M:Unused data areas</b><br>Lists the data area words and bits that aren't used in the program.   | 148  |
|                           | <b>X:Cross-references</b><br>Lists a cross-reference of operands in the program.  | 149  |
| <b>I:Change addresses</b> | <b>R:Bits/TIM/CNT</b><br>Changes program bits (IR, LR, AR, and HR Areas) and TIM/CNT numbers.   | 150  |
|                           | <b>C:Words/DM</b><br>Changes program word addresses (IR, LR, AR, HR, and DM Areas) and TIM/CNT numbers.   | 152  |
|                           | <b>W:Words and Bits</b><br>Changes program word and bit addresses (IR, LR, AR, and HR Areas). Addresses in the DM area and TIM/CNT numbers cannot be changed. | 155  |
| <b>P:Print lists</b>      | <b>U:Used data areas</b><br>Prints the bits and words used in the program.  | 158  |
|                           | <b>C:Used areas w/cmnts</b><br>Prints the bits and words used in the program with I/O comments.   | 158  |
|                           | <b>M:Unused data areas</b><br>Prints the bits and words that aren't used in the program.  | 159  |
|                           | <b>Z:Used data areas (all)</b><br>Prints all bits and words and indicates which are used in the program.  | 159  |
|                           | <b>X:Cross-references</b><br>Prints all the places where the specified bit or word is used in the program.  | 160  |
|                           | <b>L:Ladder diagram</b><br>Prints out the program as a ladder diagram.  | 161  |
|                           | <b>I:Ladder diagram &amp; I/O</b><br>Prints out the program as a ladder diagram. Letters X and Y show whether bits are allocated to Input or Output Units.    | 163  |
|                           | <b>N:Mnemonic</b><br>Prints out the program in mnemonic code.   | 163  |

| Operation                    | Function  | Page |
|------------------------------|---|------|
| <b>R:EPROM/Memory Card</b>   | <b>T:Computer ↔ ROM</b><br>The Read operation reads the program from the PROM Writer to the computer.   | 169  |
|                              | The Write operation writes the program on the computer to the PROM Writer.  | 167  |
|                              | The Verify operation compares the program on the computer to that of the PROM Writer. This operation is executed automatically when the program is read from or written to the PROM Writer. | 171  |
|                              | <b>M:Intel HEX file</b><br>Creates an Intel HEX file from the program on the computer using the designated file name.   | 173  |
| <b>N:Program conversion</b>  | <b>C:C500 → C2000H</b><br>Converts a C500 program on data disk to C2000H format and writes the result to the computer's system work area.   | 175  |
| <b>E:Create library file</b> | Creates libraries on floppy disks (2HD or 2DD) or hard disks for use in storing LSS-compatible data.  | 177  |
| <b>C:Time chart monitor</b>  | <b>R:Read</b><br>Displays time chart monitor data from the system work area.  | 178  |
|                              | <b>L:Retrieve</b><br>Retrieves time chart monitor data from a data disk to the system work area.  | 178  |
|                              | <b>S:Save</b><br>Saves time chart monitor data from the system work area to a data disk.  | 178  |
| <b>S:Instruction trace</b>   | <b>R:Read</b><br>Displays instruction trace data from the system work area.   | 179  |
|                              | <b>L:Retrieve</b><br>Retrieves instruction trace data from a data disk to the system work area.   | 179  |
|                              | <b>S:Save</b><br>Saves instruction trace data from the system work area to a data disk.   | 179  |
| <b>T:Data trace</b>          | <b>R:Read</b><br>Displays data trace data from the system work area.  | 179  |
|                              | <b>L:Retrieve</b><br>Retrieves data trace data from a data disk to the system work area.  | 179  |
|                              | <b>S:Save</b><br>Saves data trace data from the system work area to a data disk.  | 179  |
| <b>X:Set instructions</b>    | <b>E:Edit instructions</b><br>Used to edit the instructions table and thus assign instructions to function codes.   | 182  |
|                              | <b>L:Retrieve instructions</b><br>Retrieves an instructions table from a data disk file to the system work area.  | 184  |
|                              | <b>S:Save instructions</b><br>Saves the instructions table in the system work area to a data disk file.   | 183  |
| <b>A:Retrieve/Save instr</b> | <b>L:Retrieve exp instr</b><br>Retrieves expansion instruction sets from data disk files to the system work area.   | 187  |
|                              | <b>S:Save exp instr</b><br>Saves expansion instruction sets from the system work area to data disk files.   | 186  |

| Operation            | Function  | Page |
|----------------------|---|------|
| <b>Q:PC setup</b>    | <b>P:Setup</b><br>Used to set the parameters in the PC Setup in the system work area.                         | 188  |
|                      | <b>S:Save to floppy</b><br>Used to save the PC Setup in the system work area to a data disk file.             | 198  |
|                      | <b>L:Retrieve from floppy</b><br>Used to retrieve the PC Setup from a data disk file to the system work area. | 198  |
|                      | <b>C:Clear</b><br>Used to clear the PC Setup in the system work area to its default settings.                 | 198  |
| <b>U:Allocate UM</b> | Allocates portions of the C200HS user program area to store fixed DM area data and I/O comments.              | 199  |

## System Setup Menu

| Operation                         | Function   | Page |
|-----------------------------------|--|------|
| <b>K:PC model</b>                 | Specifies the model of PC that is being programmed or that is connected to the computer.   | 207  |
| <b>C:PC interface</b>             | Specifies whether the computer is connected to the PC through a peripheral bus interface, Host Link interface, or SYSMAC NET interface.  | 207  |
| <b>N:Network address</b>          | Specifies the network address and node number (address) of the PC with which the SSS is to communicate with on a SYSMAC NET network.   | 210  |
| <b>U:I/O table -- UM transfer</b> | Specifies whether the I/O table and data link tables are transferred to the user program area when the user program is transferred between the computer and PC or PROM Writer. Also specifies whether battery errors are detected. | 211  |
| <b>R:EPROM interface</b>          | Specifies the communications protocol between the PROM Writer and computer.  | 213  |
| <b>P:Printer model</b>            | Specifies the type of printer connected.   | 214  |
| <b>D:Data disk drive</b>          | Specifies the data disk drive.   | 215  |
| <b>O:Output Bit Comment Type</b>  | Specifies whether I/O comments or instruction comments are displayed with output instructions when the program display is set to Ladder (with comments) format.  | 216  |
| <b>M:Exit to DOS</b>              | Terminates SSS operation and returns to DOS.   | 216  |

## File Management Menus

| Operation                     | Function  | Page   |     |
|-------------------------------|---|--|-----|
| <b>I:Directory</b>            | Displays DOS directories for programs, I/O comments, I/O tables, etc., on the screen. File directories can be displayed individually by type. | 219  |     |
| <b>C:Copy file</b>            | Copies DOS files.   | 221  |     |
| <b>N:Change file name</b>     | Renames DOS files.  | 222  |     |
| <b>D&gt;Delete file</b>       | Deletes DOS files.  | 222  |     |
| <b>R:Create/del directory</b> | Creates or deletes subdirectories under the current directory.  | 223  |     |
| <b>L:LSS file management</b>  | Displays the "LSS File Management" menu.  | 224  |     |
|                               | <b>I:Directory</b>  | Displays LSS-compatible programs, I/O comments, I/O tables, etc., on the screen. | 225 |
|                               | <b>C:Copy file</b>  | Copies LSS-compatible files.   | 226 |
|                               | <b>N:Change file name</b>   | Renames LSS-compatible files.  | 230 |
|                               | <b>D&gt;Delete file</b>   | Deletes LSS-compatible files.  | 230 |

## Network Operations

The following operations are found on the Utility Menu under Network Support Tables.

| Operation          | Function  | Page |
|--------------------|---|------|
| <b>E:Edit</b>      | Used to input and correct data link tables.                                 | 344  |
| <b>N:Set nodes</b> | Used to set the number of nodes to participate in a data link.              | 344  |
| <b>K:Check</b>     | Used to check the data link tables for setting errors.                      | 346  |
| <b>C:Clear</b>     | Used to clear the contents of the data link tables being display on-screen. | 347  |
| <b>L:Retrieve</b>  | Used to read a data link table from a disk to the screen.                   | 348  |
| <b>S:Save</b>      | Used to save the data link table displayed on-screen to a disk.             | 348  |

The following operation is found under the PC interface on the System Setup when SYSMAC NET is specified.

| Operation          | Function   | Page |
|--------------------|--|------|
| <b>D:Data type</b> | Used to set the data type for inter-network communications.      | 210  |
| <b>R:Routing</b>   | Used to create a routing table for inter-network communications. | 351  |





# Appendix C

## Online Operations

The following tables list the basic SSS online operations.

### Monitoring Menu

| Operation                 | Function   | Page |
|---------------------------|--|------|
| <b>N:Monitor data</b>     | Uses the lower third of the display screen as a multi-item monitor area to display the status of up to 20 bits or words.   | 272  |
| <b>P:Transfer program</b> | <b>R:PC → Computer</b><br>Transfers the program, I/O table, data link table, and instructions table from the PC to the system work area of the computer.           | 252  |
|                           | <b>W:Computer → PC</b><br>Transfers the program, I/O table, data link table, and instructions table from the system work area of the computer to the PC.           | 247  |
|                           | <b>V:Verify</b><br>Compares the PC's program, I/O table, data link table, and instructions table to the ones in the system work area of the computer.              | 254  |
| <b>H:Change display</b>   | <b>L:Ladder diagram</b><br>Displays the online PC's operating status and its program in ladder diagram format. Comments will not be displayed in this mode.        | 260  |
|                           | <b>C:Ladder with comments</b><br>Displays the online PC's operating status and its program in the ladder diagram with comments format. Comments will be displayed. | 260  |
| <b>O:Online edit</b>      | Makes simple changes to the PC's program without interrupting its operation in MONITOR mode.   | 286  |
| <b>Y:Read cycle time</b>  | Reads and displays the PC's cycle time.  | 290  |
| <b>A:Clear areas</b>      | Clears the specified data areas in the PC.   | 255  |
| <b>K:Search</b>           | Finds particular instructions and comments in a PC program that is being monitored.  | 257  |
| <b>I:I/O comment</b>      | Searches for specified I/O comments in the PC's program.   | 257  |
| <b>G:Block comment</b>    | Searches for specified block comments in the PC's program.   | 257  |
| <b>M:Memory usage</b>     | Displays the amount of program memory used, the number of comments used, and the percentage of unused RAM available.   | 290  |

### DM Menu

| Operation         | Function  | Page |
|-------------------|---|------|
| <b>T:Transfer</b> | Transfers or compares DM area data between the computer and PC. | 296  |

### I/O Table Menu

| Operation                   | Function   | Page |
|-----------------------------|--|------|
| <b>T:Transfer I/O table</b> | <b>R:PC → Computer</b><br>Writes the I/O table from the PC to the computer.        | 307  |
|                             | <b>W:Computer → PC</b><br>Writes the I/O table from the computer to the PC.        | 308  |
|                             | <b>V:Compare</b><br>Compares the I/O tables in the computer and PC.                | 308  |
| <b>C:Create I/O table</b>   | Registers the actual Units mounted to the PC in the PC's I/O table.                | 304  |
| <b>V:Verify I/O table</b>   | Compares the contents of the PC's I/O table to the actual Units mounted to the PC. | 307  |

## Utility Menu

| Operation                   | Function  | Page |
|-----------------------------|---|------|
| <b>F:File memory</b>        | <b>I:File memory list</b><br>Lists the files in the File Memory Unit.   | 312  |
|                             | <b>F:Computer ↔ FM</b><br>Transfers and compares files between the computer and File Memory Unit. Also used to edit files.  | 314  |
|                             | <b>C:Clear File memory</b><br>Clears specified blocks (128-word units) of data from the File Memory Unit.                   | 319  |
|                             | <b>P:PC ↔ FM</b><br>Transfers and compares files between the PC and File Memory Unit.                                       | 319  |
|                             | <b>D:Floppy ↔ FM</b><br>Transfers and compares files between a floppy disk and the File Memory Unit.                        | 321  |
| <b>C:Time chart monitor</b> | <b>J:Execute</b><br>Sets monitoring parameters and executes the monitor operation.  | 324  |
|                             | <b>R:Read</b><br>Displays time chart monitor data from the system work area.  | 326  |
|                             | <b>L:Retrieve</b><br>Retrieves time chart monitor data from a data disk to the system work area.                            | 326  |
|                             | <b>S:Save</b><br>Saves time chart monitor data from the system work area to a data disk.                                    | 327  |
| <b>S:Instruction trace</b>  | <b>J:Execute</b><br>Sets trace parameters and executes the trace operation.   | 327  |
|                             | <b>R:Read</b><br>Displays instruction trace data from the system work area.   | 330  |
|                             | <b>L:Retrieve</b><br>Retrieves instruction trace data from a data disk to the system work area.                             | 330  |
|                             | <b>S:Save</b><br>Saves instruction trace data from the system work area to a data disk.                                     | 330  |
| <b>T:Data trace</b>         | <b>J:Execute</b><br>Sets trace parameters and executes the trace operation.   | 332  |
|                             | <b>R:Read</b><br>Displays data trace data from the system work area.  | 334  |
|                             | <b>L:Retrieve</b><br>Retrieves data trace data from a data disk to the system work area.                                    | 334  |
|                             | <b>S:Save</b><br>Saves data trace data from the system work area to a data disk.  | 335  |
| <b>D:Debug</b>              | Executes one instruction at a time or a specified block of program addresses while displaying bit status and word contents. | 335  |
| <b>K:Display/Set Clock</b>  | Used to read and set the PC's internal clock.   | 337  |
| <b>A:Transfer instr</b>     | Used to transfer expansion instruction sets from the PC to the computer.  | 337  |
| <b>Q:PC setup</b>           | <b>P:Setup</b><br>Used to set the parameters in the PC Setup in the PC.   | 337  |
|                             | <b>R:PC → Computer</b><br>Used to transfer the PC Setup from the PC to the system work area.                                | 337  |
|                             | <b>W:Computer → PC</b><br>Used to transfer the PC Setup from the system work area to the PC.                                | 337  |

## System Setup Menu

| Operation                  | Function   | Page |
|----------------------------|--|------|
| U:I/O table -- UM transfer | Specifies whether the I/O table and data link tables are transferred to the user program area when the user program is transferred between the computer and PC or PROM Writer. Also specifies whether battery errors are detected. | 211  |

## Network Operations

| Operation       | Function   | Page |
|-----------------|--|------|
| R:PC → Computer | Reads the data link table from the PC.                       | 350  |
| W:Computer → PC | Writes the data link table from the SSS to the PC.           | 350  |
| V:Verify        | Compares the data link table in the SSS to the one in the PC | 350  |



# Glossary

A glossary for the SSS is provided in the *SSS Operation Manual: Basics (W247)*.



# Index

This index covers all three SSS Operation Manuals. The manual the page numbers refer to is given in italics just prior to the number: Basics, C-series PCs, and CVM1 PCs.

## A

### addresses

- changing: *CVM1 PCs* 139; *C-series PCs* 149
- changing word and bit addresses together, ladder: *CVM1 PCs* 146

AI searches: *CVM1 PCs* 255; *C-series PCs* 258

allocating UM: *C-series PCs* 199

### allocations

- Remote I/O Master Units: *C-series PCs* 141
- Special I/O Units: *C-series PCs* 140
- C200H/C200HS Special I/O Units: *C-series PCs* 141

ASCII, format: *C-series PCs* 276

AUTOEXEC.BAT: *Basics* 9, 10, 16

## B

BCD, entering: *C-series PCs* 22

bit address, inputting: *Basics* 66

### bit addresses

- changing: *CVM1 PCs* 140, 144; *C-series PCs* 150
- changing word and bit addresses together: *C-series PCs* 155
- entering: *CVM1 PCs* 26; *C-series PCs* 22
- ladder diagrams: *C-series PCs* 22

### bits

- checking: *C-series PCs* 147, 148
- multiple
  - force-setting: *C-series PCs* 280
  - force-resetting: *C-series PCs* 280
- single
  - force-setting: *C-series PCs* 278
  - force-resetting: *C-series PCs* 278
- specifying: *C-series PCs* 273

### block comments

- copying: *C-series PCs* 79
- creating: *CVM1 PCs* 57, 61; *C-series PCs* 56, 59
- finding: *CVM1 PCs* 81
- searching: *C-series PCs* 257
- mnemonic programming: *C-series PCs* 109

bootdisk: *Basics* 9, 10, 17

Bridges, SYSMAC NET: *Basics* 107

broadcasting, SYSMAC NET: *Basics* 107

## C

C1000H: *Basics* 3

connecting to SSS: *Basics* 20

C120: *Basics* 3

connecting to SSS: *Basics* 20

C20: *Basics* 3

connecting to SSS: *Basics* 20

C2000H: *Basics* 3

connecting to SSS: *Basics* 20

C200H: *Basics* 3

connecting to SSS: *Basics* 20

CPU differences: *Basics* 3

C200H<sub>L</sub>, connecting to SSS: *Basics* 20

C200HS: *Basics* 3

connecting to SSS: *Basics* 20

C500: *Basics* 3

connecting to SSS: *Basics* 20

C500 to C2000H, program conversion: *CVM1 PCs* 161

### cables

- length: *Basics* 20
- peripheral port: *Basics* 23
- PROM Writer: *Basics* 102

### changing

- addresses: *C-series PCs* 149
- bit addresses: *C-series PCs* 150
- I/O comments: *C-series PCs* 150
- CNT, I/O comments: *C-series PCs* 150
- display modes: *C-series PCs* 13
- procedure: *C-series PCs* 16
- range, word addresses: *C-series PCs* 153
- TIM, I/O comments: *C-series PCs* 150
- word addresses: *C-series PCs* 152
- I/O comments: *C-series PCs* 153, 156

### changing word and bit addresses together

- bit addresses: *C-series PCs* 155
- word addresses: *C-series PCs* 155

### checking

- bits: *C-series PCs* 147, 148
- check level: *C-series PCs* 69
- error messages: *C-series PCs* 71
- I/O tables: *C-series PCs* 137
- ladder diagrams: *C-series PCs* 65, 69
- operands: *C-series PCs* 146
- storage capacity: *C-series PCs* 69
- words: *C-series PCs* 147, 148
  
- CIO Area
  - dividing: *CVM1 PCs* 213
  - dividing into parts: *CVM1 PCs* 210
  
- clearing
  - displays: *Basics* 40, 41
  - I/O comments: *C-series PCs* 98
  - memory: *Basics* 61; *C-series PCs* 12
    - entire program: *C-series PCs* 12
  
- clock
  - displaying/setting: *CVM1 PCs* 339
  - reading/setting: *C-series PCs* 337
  
- CNT
  - changing: *CVM1 PCs* 140, 144
  - changing operands: *C-series PCs* 150
  
- CNT numbers, changing: *C-series PCs* 150
  
- comments
  - displaying/hiding: *Basics* 40
  - finding: *C-series PCs* 257
  - I/O, UM allocations: *C-series PCs* 200
  - retrieving: *CVM1 PCs* 75
  - transferring: *C-series PCs* 312
  
- communications
  - See also* connections
  - driver: *Basics* 4
  
- compare, programs: *CVM1 PCs* 199
  
- comparison instructions, inputting: *CVM1 PCs* 33
  
- compatibility
  - data: *Basics* 2
  - LSS data: *Basics* 10, 74
  - RAM disks: *Basics* 9
  
- Completion Flags, monitoring status: *Basics* 83
  
- computer, requirements: *Basics* 4
  
- CONFIG.SYS: *Basics* 9, 10, 16
  
- configuration, SSS: *Basics* 5
  
- connecting, PC: *C-series PCs* 240
  
- connections
  - computer to PC: *Basics* 20
  - effects on operating speed: *Basics* 20
  - Memory Card Writer: *Basics* 103
  - PC: *Basics* 48
  - peripheral devices: *Basics* 102
  - peripheral port: *Basics* 23
  - printer: *Basics* 104
  - printer pin allocations: *Basics* 104
  - PROM Writer: *Basics* 102
  - RS-232C: *Basics* 20
  
- connectors, hood assembly: *Basics* 25
  
- continuing, instruction lines: *C-series PCs* 40
  
- control bits, data tracing: *CVM1 PCs* 331
  
- conversion, programs: *Basics* 2
  - C-series to CVM1: *Basics* 94
  
- converted programs, correcting: *CVM1 PCs* 489
  - C1000H/C2000H: *CVM1 PCs* 489
  - C1000H/C2000H operands: *CVM1 PCs* 510
  - C200HS: *CVM1 PCs* 501
  - C200HS operands: *CVM1 PCs* 516
  - ladder diagrams: *CVM1 PCs* 528
  
- converting
  - C2000H to CVM1, programs: *C-series PCs* 175
  - C500 to C2000H, programs: *C-series PCs* 175
  - programs: *C-series PCs* 175
  
- copying
  - block comments: *C-series PCs* 79
  - DM data: *C-series PCs* 116
  - instruction blocks: *C-series PCs* 90
  - instruction comments: *C-series PCs* 78
  
- counters
  - changing SV: *CVM1 PCs* 259; *C-series PCs* 246, 260
  - inputting: *Basics* 66
  
- CPU Bus Units: *CVM1 PCs* 350
  - communication unit settings: *CVM1 PCs* 416
  
- CPU SIOU Units
  - software switches: *CVM1 PCs* 428
  - system setup: *CVM1 PCs* 427
  
- CQM1: *Basics* 3
  - connecting to SSS: *Basics* 20
  
- creating
  - block comments: *C-series PCs* 56, 59
  - I/O comments: *C-series PCs* 56
  - instruction comments: *C-series PCs* 56, 61
  - Intel HEX file: *C-series PCs* 173
  - ladder diagrams: *C-series PCs* 18
  - LSS, data libraries: *C-series PCs* 177
  
- cross references: *CVM1 PCs* 271; *C-series PCs* 149
  - printing: *C-series PCs* 160
  
- cursor, keys: *Basics* 41
  
- cursor movement



- ladder diagram: *C-series PCs* 20
  - mnemonic programming: *C-series PCs* 102
  - custom data areas: *CVMI PCs* 339
    - comparing: *CVMI PCs* 340
    - downloading: *CVMI PCs* 340
    - retrieving: *CVMI PCs* 211
    - saving: *CVMI PCs* 211
    - uploading: *CVMI PCs* 340
  - CVMI: *Basics* 3
    - connecting to SSS: *Basics* 20
    - converting programs: *Basics* 94
    - differences between models: *CVMI PCs* 8
  - cycle time: *CVMI PCs* 447
    - PC Setup: *C-series PCs* 188
    - reading: *CVMI PCs* 290
    - reading and displaying: *C-series PCs* 290
  - cycle time monitoring time. *See* watch cycle time
- D
- data
    - changing format: *C-series PCs* 114
    - compatibility: *Basics* 2
    - copying: *C-series PCs* 116
    - debugging blocks: *C-series PCs* 336
    - displaying status: *CVMI PCs* 273; *C-series PCs* 271
    - printing: *C-series PCs* 117
    - reading: *C-series PCs* 115
    - retrieving memory data: *C-series PCs* 120
    - saving: *C-series PCs* 118
    - tracing: *CVMI PCs* 169; *C-series PCs* 179
    - transferring: *C-series PCs* 312
  - data area: *CVMI PCs* 254
    - cross references: *C-series PCs* 149
    - lists: *CVMI PCs* 135; *C-series PCs* 145
    - unused: *C-series PCs* 148
    - used: *CVMI PCs* 136; *C-series PCs* 146
      - with comments: *C-series PCs* 147
  - data areas: *C-series PCs* 255
    - changing prefixes: *CVMI PCs* 210
    - clearing. *See* data
    - unused, printing: *C-series PCs* 159
    - used, printing: *C-series PCs* 158
  - data disk drive. *See* disk drive
  - data file extensions: *CVMI PCs* 461
  - data libraries, LSS, creating: *C-series PCs* 177
  - data link table: *C-series PCs* 211
  - data link tables: *CVMI PCs* 350; *C-series PCs* 342, 354
    - checking: *C-series PCs* 346, 359
      - clearing: *C-series PCs* 347, 362
      - comparing: *C-series PCs* 350, 367
      - copying: *C-series PCs* 361
      - deleting: *C-series PCs* 370
      - editing: *C-series PCs* 344, 357
      - number of nodes: *C-series PCs* 344
      - offline: *CVMI PCs* 354
        - checking: *CVMI PCs* 357, 375
        - clearing: *CVMI PCs* 358, 378
        - copying: *CVMI PCs* 377
        - editing: *CVMI PCs* 356, 373
        - printing: *CVMI PCs* 359, 379
        - retrieving: *CVMI PCs* 358, 379
        - saving: *CVMI PCs* 358, 378
      - online: *CVMI PCs* 359
        - deleting: *CVMI PCs* 390
        - monitoring status: *CVMI PCs* 393
        - retrieving: *CVMI PCs* 360, 382
        - saving: *CVMI PCs* 391
        - starting: *CVMI PCs* 392
        - starting/stopping: *CVMI PCs* 365
        - stopping: *CVMI PCs* 392
        - transferring: *CVMI PCs* 361, 382
    - retrieving: *C-series PCs* 348, 362, 364
    - saving: *C-series PCs* 348, 362, 371
    - SYSMAC LINK – offline: *C-series PCs* 355
    - SYSMAC LINK – online: *C-series PCs* 363
    - SYSMAC NET: *C-series PCs* 343
    - transferring: *C-series PCs* 349, 365
  - data links: *CVMI PCs* 350
  - data links (SYSMAC LINK)
    - monitoring: *C-series PCs* 372
    - starting: *C-series PCs* 372
    - stopping: *C-series PCs* 372
  - data lists, printing: *C-series PCs* 157
  - data memory
    - displaying pages: *CVMI PCs* 106
    - fixed: *C-series PCs* 200
    - transfer verification: *C-series PCs* 299
    - transferring: *C-series PCs* 296
    - transferring to computer: *C-series PCs* 296
    - transferring to PC: *C-series PCs* 296
  - data tracing: *CVMI PCs* 169, 330; *C-series PCs* 330
    - control bits and flags: *CVMI PCs* 331
    - executing: *CVMI PCs* 336
      - inputting parameters: *CVMI PCs* 336
      - resetting parameters: *CVMI PCs* 336
    - interrupting: *CVMI PCs* 338
    - menu: *CVMI PCs* 333
    - reading: *CVMI PCs* 169
    - reading trace data: *C-series PCs* 334
    - retrieving: *CVMI PCs* 170, 337
    - retrieving trace data from data disk: *C-series PCs* 334
    - saving: *CVMI PCs* 171, 338
    - saving trace data to data disk: *C-series PCs* 335
    - setting parameters: *CVMI PCs* 334
  - DEBUG mode: *Basics* 40

- debugging
  - data blocks: *C-series PCs* 336
  - instructions: *C-series PCs* 336
  - requirements: *C-series PCs* 335
- delete mode: *C-series PCs* 107
- deleting
  - I/O comments, unused: *C-series PCs* 99
  - I/O tables: *C-series PCs* 126
  - instruction blocks: *C-series PCs* 90
  - instructions/characters: *Basics* 41
  - line connections: *C-series PCs* 30
- detect long cycles, PC Setup: *C-series PCs* 189
- differential monitoring: *CVMI PCs* 268; *C-series PCs* 269
- disk drive: *C-series PCs* 215
  - setting: *Basics* 50
- display, requirements: *Basics* 4
- display codes: *CVMI PCs* 307
  - I/O tables: *C-series PCs* 130
- display message number, setting: *CVMI PCs* 223
- display mode: *C-series PCs* 260
  - changing: *CVMI PCs* 16, 258
  - ladder diagrams with four comment rows: *CVMI PCs* 18
  - ladder diagrams with no comments: *CVMI PCs* 17
  - ladder diagrams with two comment rows: *CVMI PCs* 18
  - mnemonic: *CVMI PCs* 19
- display modes
  - changing: *C-series PCs* 13
  - ladder diagram: *C-series PCs* 14
  - ladder diagram with comments: *C-series PCs* 15
  - mnemonics: *C-series PCs* 15
- displaying
  - memory usage: *C-series PCs* 17
  - expansion DM area: *C-series PCs* 18
  - I/O comments: *C-series PCs* 18
  - ladder program area: *C-series PCs* 18
  - PC comments transferred: *C-series PCs* 18
  - user program: *C-series PCs* 18
  - work space: *C-series PCs* 18
  - time chart monitor data: *C-series PCs* 178
- displays, basic: *Basics* 42, 43
- DM: *CVMI PCs* 296
  - changing prefixes: *CVMI PCs* 212
  - copying: *CVMI PCs* 107
  - editing: *C-series PCs* 112
  - fill: *CVMI PCs* 108
  - HEX - ASCII: *C-series PCs* 114
  - HEX-ASCII switching: *CVMI PCs* 106
- inputting DM addresses: *C-series PCs* 115
- menu: *C-series PCs* 113
- printing: *CVMI PCs* 108
- reading: *C-series PCs* 115
- reading an address: *CVMI PCs* 106
- reading data: *CVMI PCs* 104
- retrieving data: *CVMI PCs* 111
- saving data: *CVMI PCs* 110
- writing: *C-series PCs* 114
- writing data: *CVMI PCs* 104
- DM data
  - converting: *Basics* 93
  - copying: *C-series PCs* 116
  - initializing: *C-series PCs* 123
  - printing: *C-series PCs* 117
  - retrieving: *C-series PCs* 119
  - saving: *C-series PCs* 117
- DM words, filling: *C-series PCs* 116
- DOS
  - DISKCOPY: *Basics* 8
  - file list: *C-series PCs* 4
  - file name: *C-series PCs* 4
  - FORMAT: *Basics* 9
  - path name: *C-series PCs* 4
  - retrieving files: *C-series PCs* 4
  - returning: *Basics* 19
  - saving files: *C-series PCs* 4
  - title: *C-series PCs* 4
  - version: *Basics* 4
- DOS files
  - retrieving: *CVMI PCs* 4
  - saving: *CVMI PCs* 4
- downloading
  - custom data areas: *CVMI PCs* 340
  - routing tables: *CVMI PCs* 410
  - SYSMAC LINK data link tables: *CVMI PCs* 385
  - SYSMAC NET data link tables: *CVMI PCs* 363

## E

- editing
  - DM: *C-series PCs* 112
  - I/O comments: *C-series PCs* 93
  - I/O tables: *C-series PCs* 126
  - insert mode, ladder diagrams: *C-series PCs* 55
  - instruction blocks: *C-series PCs* 90
    - operations: *C-series PCs* 91
    - range: *C-series PCs* 90
  - instruction tables: *C-series PCs* 182
  - ladder diagrams: *C-series PCs* 42
  - mnemonic programming: *C-series PCs* 107
    - delete mode: *C-series PCs* 107
    - insert mode: *C-series PCs* 107
    - write mode: *C-series PCs* 107
  - monitor display, ladder: *CVMI PCs* 258

PC IDs: *CVMI PCs 200*  
 function key operations: *CVMI PCs 202*  
 write mode  
   bit address: *C-series PCs 44*  
   blank column: *C-series PCs 48*  
   blank line: *C-series PCs 49, 51*  
   CNT: *C-series PCs 47*  
   ladder diagrams: *C-series PCs 43, 63*  
   NC condition: *C-series PCs 54*  
   NO condition: *C-series PCs 54*  
   OR: *C-series PCs 52*  
   symbol: *C-series PCs 44, 46*  
   vertical connection: *C-series PCs 45*

editing mode, ladder diagram: *C-series PCs 19*

editing modes, programming: *C-series PCs 10*

EM  
   comparing: *CVMI PCs 302*  
   inputting EM addresses: *C-series PCs 115*  
   retrieving: *CVMI PCs 299*  
   saving: *CVMI PCs 298*  
   transferring: *CVMI PCs 300*

entering  
   BCD: *C-series PCs 22*  
   bit addresses: *C-series PCs 22*  
   input conditions: *C-series PCs 20*  
   mnemonic programming: *C-series PCs 103*  
   right-hand instructions: *C-series PCs 21*  
   word addresses: *C-series PCs 22*

EPROM: *C-series PCs 164*  
   Intel hex files: *C-series PCs 164*  
   reading: *C-series PCs 169*  
   system setup: *C-series PCs 165*  
   verifying programs: *C-series PCs 171*  
   writing: *C-series PCs 167*

EPROM interface: *CVMI PCs 223; C-series PCs 213*

error messages: *CVMI PCs 341, 453; C-series PCs 71, 381*  
   access right: *CVMI PCs 343*  
   current directory: *CVMI PCs 341*  
   history: *CVMI PCs 342*  
   routing tables  
     local network table: *CVMI PCs 404*  
     relay network tables: *CVMI PCs 404*  
   SYSMAC LINK data link parameters  
     common link parameters: *CVMI PCs 376*  
     refresh parameters: *CVMI PCs 377*

errors  
   clearing: *CVMI PCs 273; C-series PCs 271*  
   I/O table errors: *CVMI PCs 118; C-series PCs 128*

examples, ladder diagram programming: *C-series PCs 23*

exiting, SSS: *Basics 19; CVMI PCs 224*

exiting SSS: *C-series PCs 216*

expansion DM area, allocation: *C-series PCs 200*

expansion instructions: *C-series PCs 185*  
   retrieving: *C-series PCs 187*  
   saving: *C-series PCs 186*  
   transferring: *C-series PCs 187*

expansion memory, requirements: *Basics 4*

## F

features: *Basics 2*

file memory  
   clearing: *C-series PCs 319*  
   comments transfer: *C-series PCs 316*  
   data transfer from floppy disk to Unit: *C-series PCs 322*  
   data transfer from PC to Unit: *C-series PCs 319*  
   data transfer from Unit to floppy disk: *C-series PCs 321*  
   data transfer from Unit to PC: *C-series PCs 320*  
   DM transfer: *C-series PCs 315*  
   editing data blocks: *C-series PCs 317*  
   lists: *C-series PCs 312*  
   program transfer: *C-series PCs 314*  
   verifying data transfer to Unit: *C-series PCs 321*

files  
   data  
     retrieving: *CVMI PCs 112*  
     saving: *CVMI PCs 112*  
   DOS: *CVMI PCs 4*  
   DOS files: *CVMI PCs 226; C-series PCs 219*  
   LSS: *CVMI PCs 4*  
   LSS files: *CVMI PCs 233; C-series PCs 224*  
   management: *C-series PCs 218*

filling, DM words, same content: *C-series PCs 116*

finding, I/O comments: *C-series PCs 100*

FINS command response codes, displays: *CVMI PCs 459*

fixed DM area, expansion: *C-series PCs 199*

flags, data tracing: *CVMI PCs 331*

floppy disks  
   handling: *Basics 6*  
   requirements: *Basics 4*  
   retrieving PC Setup: *C-series PCs 198*  
   saving PC Setup: *C-series PCs 198*  
   write protection: *Basics 6*

force-reset operation: *Basics 84*

force-set/force-reset, basic operation: *Basics 83*

forced status

PC Setup: *C-series PCs* 188

releasing: *Basics* 84

function code list: *CVMI PCs* 465

function codes

customizing

retrieving: *CVMI PCs* 211

saving: *CVMI PCs* 211

inputting: *Basics* 70

mnemonic programming: *C-series PCs* 103

right-hand instructions: *C-series PCs* 22

function keys: *C-series PCs* 245, 272

basic operations: *Basics* 48

I/O tables: *C-series PCs* 130

ladder diagram: *C-series PCs* 19

mnemonic programming: *C-series PCs* 105

online assignments: *CVMI PCs* 273; *C-series PCs* 271

## G

Group-2 Multipoint I/O Units, I/O tables: *C-series PCs* 135

guidance displays. *See* help screens

## H

hard disk

requirements: *Basics* 4

space requirements: *Basics* 4, 9

hardware, requirements: *Basics* 4

help

displaying: *Basics* 40

messages: *Basics* 51

help screens, for I/O table display codes: *CVMI PCs* 313

HEX – ASCII, changing data type: *C-series PCs* 114

HIS programs: *CVMI PCs* 214–215

deleting: *CVMI PCs* 215

recording: *CVMI PCs* 214

Host Link, connecting to PC: *Basics* 20

Host Link Units: *Basics* 20, 102

models: *Basics* 105

I/O, allocation, I/O table: *Basics* 77

I/O comment area, allocation: *C-series PCs* 200

I/O comments

bit addresses

changing: *C-series PCs* 150

replacing: *C-series PCs* 150

clearing: *CVMI PCs* 92; *C-series PCs* 98

CNT

changing: *C-series PCs* 150

replacing: *C-series PCs* 150

comment change: *CVMI PCs* 142

comment editing screen: *C-series PCs* 93

converting: *Basics* 93

copying: *C-series PCs* 96

creating: *CVMI PCs* 57, 58; *C-series PCs* 56

coding: *C-series PCs* 57

existing programs: *C-series PCs* 58

deleting: *C-series PCs* 99

edit comment menu: *C-series PCs* 94

editing: *CVMI PCs* 88; *C-series PCs* 93

finding: *CVMI PCs* 81; *C-series PCs* 100

finding data: *CVMI PCs* 93

inputting: *C-series PCs* 93

modifying: *C-series PCs* 95

printing: *CVMI PCs* 92

reading: *CVMI PCs* 91

saving: *CVMI PCs* 91

searching: *C-series PCs* 257

TIM

changing: *C-series PCs* 150

replacing: *C-series PCs* 150

word addresses

changing: *C-series PCs* 153, 156

replacing: *C-series PCs* 153, 156

writing: *C-series PCs* 95, 99

I/O monitor: *CVMI PCs* 273

I/O monitor display: *CVMI PCs* 274, 292

I/O table

creating: *Basics* 77

display format: *C-series PCs* 129

C200H/C200HS: *C-series PCs* 129

general: *C-series PCs* 129

errors: *C-series PCs* 128

writing: *CVMI PCs* 119

I/O tables: *C-series PCs* 133

changing in the PC: *CVMI PCs* 314; *C-series PCs* 305

checking: *CVMI PCs* 126; *C-series PCs* 137

checking data: *C-series PCs* 137

clearing in the PC: *C-series PCs* 308

comparing: *CVMI PCs* 309; *C-series PCs* 308

creating in the PC: *CVMI PCs* 314; *C-series PCs* 305

deleting: *C-series PCs* 126

display code, Special I/O Units: *C-series PCs* 140

- display codes: *CVM1 PCs 307*
- displaying
  - SYSMAC BUS Slaves: *CVM1 PCs 312*
  - SYSMAC BUS/2 Slaves: *CVM1 PCs 310*
- editing: *CVM1 PCs 119; C-series PCs 126*
- entering
  - CPU Bus Units: *CVM1 PCs 121*
  - I/O Terminals: *CVM1 PCs 123*
  - SYSMAC BUS Slaves: *CVM1 PCs 122*
  - SYSMAC BUS/2 Slaves: *CVM1 PCs 124*
- Group-2 Multipoint I/O Units: *C-series PCs 135*
- guidance displays
  - CPU Bus Unit: *CVM1 PCs 308*
  - Group-2 events: *CVM1 PCs 308*
  - I/O terminals: *CVM1 PCs 308*
  - I/O Units: *CVM1 PCs 307*
  - interrupt units: *CVM1 PCs 308*
  - SYSMAC BUS Masters: *CVM1 PCs 308*
- menu: *C-series PCs 127*
- Multipoint I/O Units: *C-series PCs 135*
- printing: *C-series PCs 139*
- retrieving: *CVM1 PCs 128; C-series PCs 138, 139*
- saving: *CVM1 PCs 127; C-series PCs 138*
- Slave Racks: *C-series PCs 131*
- transferring: *CVM1 PCs 309; C-series PCs 307*
- verifying: *C-series PCs 307*
- verifying with actual Units: *CVM1 PCs 316*
- writing: *C-series PCs 131*
  - function keys: *CVM1 PCs 119*
- I/O Units, replacing, during operation: *C-series PCs 308*
- I/O word allocations, Special I/O Units: *C-series PCs 141*
- initializing, DM data: *C-series PCs 123*
- input conditions
  - entering: *CVM1 PCs 24, 27; C-series PCs 20*
  - ladder diagrams: *C-series PCs 20, 23*
- input mode, changing: *CVM1 PCs 21*
- insert mode: *C-series PCs 107*
- installation
  - aborting: *Basics 10*
  - directory: *Basics 9, 13*
  - general procedures: *Basics 10*
  - installation disk backup: *Basics 8*
  - modifying: *Basics 12*
  - procedure: *Basics 10*
  - SSS: *Basics 9*
  - SYSMAC NET: *Basics 15*
- instruction blocks: *C-series PCs 13, 66*
  - copying: *C-series PCs 90*
  - deleting: *C-series PCs 90*
  - displaying: *Basics 41*
  - editing: *CVM1 PCs 84; C-series PCs 90*
  - incomplete instruction lines: *C-series PCs 67*
  - incorrect: *C-series PCs 67*
  - moving: *C-series PCs 90*
- instruction comments
  - copying: *C-series PCs 78*
  - creating: *C-series PCs 56, 61*
- instruction lines: *C-series PCs 13*
  - continuing: *CVM1 PCs 44; C-series PCs 40*
  - incomplete: *C-series PCs 67*
  - ladder diagram: *C-series PCs 19*
- instruction tables: *C-series PCs 180*
  - editing: *C-series PCs 182*
  - retrieving: *C-series PCs 184*
  - saving: *C-series PCs 183*
- instruction trace data: *C-series PCs 179*
- instruction tracing: *C-series PCs 327*
  - reading trace data: *C-series PCs 330*
  - retrieving trace data from data disk: *C-series PCs 330*
  - saving trace data to data disk: *C-series PCs 330*
- instructions
  - debugging: *C-series PCs 336*
  - deleting: *Basics 41*
  - finding: *CVM1 PCs 255; C-series PCs 257*
  - inputting: *Basics 65*
  - inserting: *Basics 41*
  - searching: *C-series PCs 257*
  - special, displaying: *Basics 40*
- Intel HEX file, creating: *C-series PCs 173*
- interrupt programs: *CVM1 PCs 86*
  - editing, ladder: *CVM1 PCs 289*
- IOM hold bit status, PC Setup: *C-series PCs 188*

## K

- K-type PCs: *Basics 3*
- keyboard: *Basics 40*
  - requirements: *Basics 4*
- keys, main control: *Basics 60*
- K-type PCs, connecting to SSS: *Basics 20*

## L

- ladder diagrams
  - bit addresses: *CVM1 PCs 26; C-series PCs 22*
  - block comments: *CVM1 PCs 81; C-series PCs 56, 59*
  - checking: *CVM1 PCs 68; C-series PCs 19, 65, 69*
  - clearing memory: *CVM1 PCs 14; C-series PCs 18*
  - connecting lines: *Basics 40, 68*
  - creating: *CVM1 PCs 22; C-series PCs 18*

cursor movement: *C-series PCs* 20  
 display format: *CVMI PCs* 12; *C-series PCs* 260  
 display mode: *CVMI PCs* 16  
 editing: *CVMI PCs* 84; *C-series PCs* 42  
     insert mode: *C-series PCs* 55  
     write mode: *C-series PCs* 43, 63  
 editing mode: *CVMI PCs* 23; *C-series PCs* 19  
 function keys: *CVMI PCs* 23; *C-series PCs* 19  
 I/O bits, printing: *C-series PCs* 163  
 I/O comments: *CVMI PCs* 81; *C-series PCs* 56  
 input conditions: *CVMI PCs* 21, 24, 27; *C-series PCs* 20, 23  
 instruction comments: *C-series PCs* 56, 61  
 instruction lines: *CVMI PCs* 23; *C-series PCs* 19  
 line connections: *C-series PCs* 30  
 memory: *CVMI PCs* 20  
 mnemonic mode: *C-series PCs* 101  
 moving the cursor: *CVMI PCs* 23  
 operands: *C-series PCs* 25  
 output conditions: *CVMI PCs* 27  
 printing: *C-series PCs* 161  
 programming: *CVMI PCs* 22; *C-series PCs* 18  
 reading: *CVMI PCs* 75, 83; *C-series PCs* 80, 89  
 retrieving: *CVMI PCs* 71, 73; *C-series PCs* 71, 74  
 retrieving program: *C-series PCs* 18  
 right-hand instructions: *CVMI PCs* 25; *C-series PCs* 21, 24  
 saving: *CVMI PCs* 71; *C-series PCs* 71  
 searching: *CVMI PCs* 75, 83, 255; *C-series PCs* 80, 89, 257  
 setting display mode: *C-series PCs* 19  
 special instructions: *C-series PCs* 27  
 storing: *CVMI PCs* 64; *C-series PCs* 65  
 system setup: *C-series PCs* 18  
 timer instructions: *C-series PCs* 25  
 word addresses: *CVMI PCs* 26; *C-series PCs* 22  
  
 ladder program input screen: *C-series PCs* 19  
 ladder programming screen: *C-series PCs* 10  
  
 ladder programs, editing: *CVMI PCs* 46  
     write mode: *CVMI PCs* 46  
  
 line connections  
     ladder diagrams: *C-series PCs* 30  
     long connecting lines: *C-series PCs* 36  
     long horizontal lines: *CVMI PCs* 38; *C-series PCs* 34  
     multiple inputs: *CVMI PCs* 41; *C-series PCs* 37  
     parallel OUTPUT instructions: *CVMI PCs* 37; *C-series PCs* 33, 39  
     single horizontal line: *CVMI PCs* 35; *C-series PCs* 31  
     single vertical line: *CVMI PCs* 36; *C-series PCs* 32  
     writing: *CVMI PCs* 34  
  
 lines, connecting: *Basics* 40, 68  
  
 Link Adapters: *Basics* 105  
  
 LSS  
     data libraries: *Basics* 74; *C-series PCs* 4

creating: *C-series PCs* 177  
 drive name: *C-series PCs* 6  
 file list: *C-series PCs* 6  
 file name: *C-series PCs* 6  
 reading: *Basics* 10  
 retrieving files: *C-series PCs* 5  
 saving files: *C-series PCs* 5

## M

main memory, requirements: *Basics* 4  
  
 memory  
     clearing: *Basics* 61; *CVMI PCs* 14; *C-series PCs* 12  
     entire program: *CVMI PCs* 15  
     specified range: *CVMI PCs* 15  
     displaying usage: *CVMI PCs* 20, 291; *C-series PCs* 17  
     block comments: *CVMI PCs* 20  
     I/O comments: *CVMI PCs* 20  
     internal memory: *CVMI PCs* 20  
     PC memory: *CVMI PCs* 20  
     requirements: *Basics* 4  
  
 memory banks, switching: *CVMI PCs* 109  
  
 memory card: *CVMI PCs* 320  
     copying files: *CVMI PCs* 159  
     deleting files: *CVMI PCs* 160  
     file types and extensions: *CVMI PCs* 323  
     initialization: *CVMI PCs* 155  
     Memory Card Writer: *CVMI PCs* 154  
         buffer RAM: *CVMI PCs* 154  
     menu operations: *CVMI PCs* 154  
     printing: *CVMI PCs* 161  
     renaming files: *CVMI PCs* 160  
     transferring between computer and memory card: *CVMI PCs* 329  
     transferring files  
         computer to memory card: *CVMI PCs* 157  
         memory to computer: *CVMI PCs* 158  
     transferring from memory card to PC  
         all programs: *CVMI PCs* 327  
         extended PC Setup: *CVMI PCs* 329  
         IOM words: *CVMI PCs* 328  
     transferring from PC to memory card  
         extended PC Setup: *CVMI PCs* 326  
         IOM words: *CVMI PCs* 326  
         programs: *CVMI PCs* 323  
  
 Memory Card Writer: *Basics* 102  
     models: *Basics* 105  
  
 menus  
     changing: *Basics* 42  
     controlling: *Basics* 44  
         shortcut: *Basics* 46  
     displaying: *Basics* 40  
     DM: *CVMI PCs* 103, xi; *C-series PCs* 293, 294  
     I/O TABLE, offline: *C-series PCs* 125  
     I/O table, online: *C-series PCs* 301

main: *Basics* 45  
 offline operations: *Basics* 44  
 online operations: *Basics* 45  
 system: *Basics* 40  
 UTILITY: *C-series PCs* 143  
 Utility: *CVM1 PCs* xii

Mini H-type PCs: *Basics* 3  
 connecting to SSS: *Basics* 20

mnemonic  
 correcting: *CVM1 PCs* 99  
 editing: *C-series PCs* 107  
 entering: *CVM1 PCs* 96; *C-series PCs* 103  
 function keys: *C-series PCs* 105  
 programming: *CVM1 PCs* 94; *C-series PCs* 101  
 cursor movement: *CVM1 PCs* 95; *C-series PCs* 102  
 programming screen: *C-series PCs* 102  
 reading: *CVM1 PCs* 100; *C-series PCs* 108  
 searching: *CVM1 PCs* 100; *C-series PCs* 108  
 typing mnemonics: *C-series PCs* 105  
 word addresses: *C-series PCs* 105  
 writing: *CVM1 PCs* 99; *C-series PCs* 106

mnemonic list: *CVM1 PCs* 471

mnemonic mode, ladder diagrams: *C-series PCs* 101

mnemonics  
 display modes: *C-series PCs* 15  
 printing: *C-series PCs* 163

models, standard: *Basics* 105

modifying, I/O comments: *C-series PCs* 95

Monitor Data: *C-series PCs* 271

MONITOR mode: *Basics* 40, 80

monitoring: *C-series PCs* 244  
 bit status: *Basics* 82  
 Completion Flags: *Basics* 83  
 cross references, ladder: *CVM1 PCs* 271  
 differential: *Basics* 84; *C-series PCs* 269  
 I/O status: *Basics* 81  
 menu, ladder: *CVM1 PCs* 249  
 pausing: *CVM1 PCs* 262; *C-series PCs* 265  
 PC operation: *Basics* 81  
 scan time: *Basics* 90  
 status: *CVM1 PCs* 268

moving  
 I/O comments: *C-series PCs* 96  
 instruction blocks: *C-series PCs* 90

MS-Windows: *Basics* 4

Multipoint I/O Units, I/O tables: *C-series PCs* 135

## N

network address  
 SYSMAC LINK: *CVM1 PCs* 222  
 SYSMAC NET: *CVM1 PCs* 222; *C-series PCs* 210

network diagnosis: *CVM1 PCs* 350

network operations, summary: *CVM1 PCs* 485

network parameters, setting: *C-series PCs* 376

Network Support Boards, SYSMAC NET: *Basics* 107

network support tables: *CVM1 PCs* 350

## O

offline operations  
 menus: *Basics* 44  
 summary: *CVM1 PCs* 475; *C-series PCs* 387

online: *C-series PCs* 245  
 editing: *C-series PCs* 286

online connection, C-series PCs, SYSMAC LINK: *Basics* 109

online operations: *Basics* 76  
 changing from offline: *CVM1 PCs* 248; *C-series PCs* 241  
 connecting: *Basics* 48  
 connecting to PC: *Basics* 20, 76  
 menus: *Basics* 45  
 summary: *CVM1 PCs* 481; *C-series PCs* 393  
 switching between offline and online: *Basics* 40

operands  
 checking: *CVM1 PCs* 136; *C-series PCs* 146  
 inputting: *Basics* 71  
 ladder diagrams: *C-series PCs* 25

operating mode, startup: *C-series PCs* 190

operating modes, PC: *Basics* 40

operating parameters. *See* PC Setup; System Setup

operations  
 cancelling: *Basics* 40  
 going online: *Basics* 76  
 monitoring: *Basics* 81  
 offline: *Basics* 53  
 online: *Basics* 56  
 online requirements: *C-series PCs* 240  
 online/offline: *Basics* 52  
 summary of network operations: *CVM1 PCs* 485  
 summary of offline operations: *CVM1 PCs* 475; *C-series PCs* 387  
 summary of online operations: *CVM1 PCs* 481; *C-series PCs* 393

Optical I/O Units

C200H/C200HS: *C-series PCs* 134  
I/O tables: *C-series PCs* 133

option menu: *CVMI PCs* 239; *C-series PCs* 231

output conditions, entering: *CVMI PCs* 27

**P**

P-type PCs, connecting to SSS: *Basics* 20

path setting, saving data: *CVMI PCs* 224

pause: *C-series PCs* 286

pause monitoring: *CVMI PCs* 262; *C-series PCs* 265

PC, setting model: *Basics* 50; *CVMI PCs* 219

PC data areas: *CVMI PCs* 463

PC IDs

changing: *CVMI PCs* 202  
checking: *CVMI PCs* 207  
clearing: *CVMI PCs* 205  
edit menu: *CVMI PCs* 202  
fill: *CVMI PCs* 204  
finding: *CVMI PCs* 208  
printing: *CVMI PCs* 206  
retrieving: *CVMI PCs* 204  
saving: *CVMI PCs* 203  
sorting: *CVMI PCs* 208  
writing: *CVMI PCs* 202

PC interface: *CVMI PCs* 219; *C-series PCs* 207

Host Link: *CVMI PCs* 221; *C-series PCs* 209

Host Link (SYSMAC LINK): *C-series PCs* 209

peripheral: *CVMI PCs* 220; *C-series PCs* 207

peripheral bus (SYSMAC LINK): *C-series PCs* 208

SYSMAC NET: *C-series PCs* 210

PC model: *C-series PCs* 207

PC Setup: *CVMI PCs* 171; *C-series PCs* 187

clearing: *CVMI PCs* 193; *C-series PCs* 198

default settings: *CVMI PCs* 172, 173

defaults: *C-series PCs* 187

displays

CPU Bus Links: *CVMI PCs* 183

cycle monitoring time: *CVMI PCs* 190

cycle time: *CVMI PCs* 189

display mode at startup: *CVMI PCs* 191

error log area: *CVMI PCs* 190

execution controls 1: *CVMI PCs* 180

execution controls 2: *CVMI PCs* 181

first words for Group-1 and Group-2 Slaves: *CVMI PCs* 184

first words for Group-3 Slaves: *CVMI PCs* 186

first words for I/O terminals: *CVMI PCs* 185

first words for local racks: *CVMI PCs* 184

host link: *CVMI PCs* 182

I/O refresh: *CVMI PCs* 179

momentary power interruption time: *CVMI PCs* 189

scheduled interrupt interval: *CVMI PCs* 183

startup hold: *CVMI PCs* 177

startup mode: *CVMI PCs* 178

startup processing: *CVMI PCs* 178

editing: *CVMI PCs* 175

HEX input: *C-series PCs* 197

restrictions: *C-series PCs* 188

retrieving: *CVMI PCs* 193

saving: *CVMI PCs* 192

settings: *C-series PCs* 188

system setup, details: *CVMI PCs* 193

PC Setup, HEX input: *C-series PCs* 189

PCs

applicable range: *Basics* 3

changing operation parameters: *C-series PCs* 187

connection: *Basics* 76

controlling operation: *Basics* 80

model setting: *Basics* 61

monitoring in time-chart form: *C-series PCs* 323

operating modes: *Basics* 40, 48

Peripheral Interface Unit, models: *Basics* 105

peripheral port

connecting to PC: *Basics* 20

connections: *Basics* 23

personal computer. *See* computer

precautions: *Basics* xi-xiv, 6; *CVMI PCs* xiii; *C-series PCs* xiii

PC connections: *Basics* 20

restarting computer: *Basics* 19

present values, changing: *C-series PCs* 284

printer: *C-series PCs* 214

printers

connecting: *Basics* 102

connections: *Basics* 104

models: *Basics* 105; *CVMI PCs* 223

printing

cross references: *C-series PCs* 160

data areas

unused: *C-series PCs* 159

used: *C-series PCs* 158

data lists: *CVMI PCs* 147; *C-series PCs* 157

displays: *Basics* 41

DM data: *C-series PCs* 117

I/O bits, ladder diagrams: *C-series PCs* 163

I/O tables: *C-series PCs* 139

ladder diagrams: *CVMI PCs* 151; *C-series PCs* 161

mnemonics: *CVMI PCs* 153; *C-series PCs* 163

specified instructions: *C-series PCs* 160



procedures

*See also operations*  
    outline: *Basics 5*

processor: *Basics 4*

program conversion, C500 to C2000H: *CVMI PCs 161*

PROGRAM mode: *Basics 40, 80*

PROGRAMMING, STORE mode: *CVMI PCs 63*

programming

    basic flow: *Basics 60*  
    checking: *Basics 73*  
    converting programs for CVM1: *Basics 94*  
    editing modes: *C-series PCs 10*  
    inputting: *Basics 60, 62*  
    ladder diagrams: *C-series PCs 18*  
    menu: *C-series PCs 11*  
    mnemonic: *C-series PCs 101*  
    online editing: *Basics 86*  
    operations: *C-series PCs 12*  
    saving programs: *Basics 74, 75*  
    screen: *C-series PCs 11*  
    storing: *Basics 72*  
    transferring programs: *Basics 79*

programs

    C2000H to CVM1, converting: *C-series PCs 175*  
    C500 to C2000H, converting: *C-series PCs 175*  
    comparing: *CVMI PCs 199, 253; C-series PCs 254*  
    converting: *Basics 2; C-series PCs 165, 175*  
    editing on-line: *CVMI PCs 286; C-series PCs 286*  
    transferring: *C-series PCs 246*  
    to the computer: *CVMI PCs 253; C-series PCs 252*  
    to the PC: *CVMI PCs 251; C-series PCs 247*

PROM Writer

    connections diagram: *Basics 102*  
    models: *Basics 105*  
    settings: *C-series PCs 165*

PROM Writers: *Basics 102*

P-type PCs: *Basics 3*

**R**

RAM disk: *Basics 9, 15*

    CONFIG.SYS: *Basics 9*

RAM disk driver: *Basics 4*

RAMDRIVE.SYS: *Basics 9*

read mode: *C-series PCs 81*

reading

    DM: *C-series PCs 115*

    EPROM: *C-series PCs 169*

    ladder diagrams: *C-series PCs 80*

    mnemonic programming: *C-series PCs 108*

    read mode: *C-series PCs 81*

    summary of operations: *C-series PCs 89*

Remote I/O Systems, Remote I/O Master Units, number of Units connectable: *C-series PCs 141*

replacing

    bit addresses, I/O comments: *C-series PCs 150*  
    CNT, I/O comments: *C-series PCs 150*  
    TIM, I/O comments: *C-series PCs 150*  
    word addresses, I/O comments: *C-series PCs 153, 156*

response codes, FINS commands, displays: *CVMI PCs 459*

retrieving

    blocks: *C-series PCs 74*  
    comments: *C-series PCs 76*  
    data trace: *CVMI PCs 337*  
    DM data: *C-series PCs 119*  
    expansion instructions: *C-series PCs 187*  
    I/O tables: *C-series PCs 138, 139*  
    instruction tables: *C-series PCs 184*  
    ladder diagrams: *C-series PCs 71, 74*  
    time chart monitor data: *C-series PCs 178*

right-hand instructions

    entering: *CVMI PCs 25; C-series PCs 21*  
    function codes: *C-series PCs 22*  
    ladder diagrams: *C-series PCs 21, 24*

ROM chip

    numbering: *C-series PCs 165*  
    selecting: *C-series PCs 165*

routing tables: *CVMI PCs 350*

    C-series PCs communication: *CVMI PCs 399*

    checking: *CVMI PCs 403*

    clearing: *CVMI PCs 404*

    comparing: *CVMI PCs 411*

    creating: *C-series PCs 351*

    downloading: *CVMI PCs 410*

    error message table

        local network table: *CVMI PCs 404*

        relay network table: *CVMI PCs 404*

    modifying: *C-series PCs 351*

    network communication range: *CVMI PCs 399*

    printing: *CVMI PCs 406*

    retrieving: *CVMI PCs 405, 407*

    saving: *CVMI PCs 404, 412*

    SYSMAC NET: *Basics 107*

    transferring: *CVMI PCs 410*

    uploading: *CVMI PCs 409*

RS-232C

    connecting to PC: *Basics 20*

    connections

        C-series PCs: *Basics 21*

        CVM1: *Basics 22*

connectors: *Basics* 20  
 pin assignments: *Basics* 21  
 PROM Writer connection: *Basics* 102  
 wiring connectors: *Basics* 24

RS-232C setup, PC Setup: *C-series PCs* 189

RUN mode: *Basics* 40, 80

**S**

S3200: *Basics* 107

saving  
 DM data: *C-series PCs* 117  
 DOS format: *C-series PCs* 71  
 expansion instructions: *C-series PCs* 186  
 floppy disks: *C-series PCs* 72  
 I/O tables: *C-series PCs* 138  
 instruction tables: *C-series PCs* 183  
 ladder diagrams: *C-series PCs* 71  
 LSS format: *C-series PCs* 71  
 time chart monitor data: *C-series PCs* 178

scan time, reading: *Basics* 90

scrolling: *Basics* 41

searching  
 AI: *CVM1 PCs* 255  
 bit: *C-series PCs* 84  
 bit addresses: *C-series PCs* 83  
 block comments: *C-series PCs* 87, 88  
 function codes: *C-series PCs* 86  
 I/O bits: *C-series PCs* 85  
 I/O comments: *C-series PCs* 87  
 instructions via function codes: *C-series PCs* 85  
 ladder diagrams: *C-series PCs* 80  
 mnemonic programming: *C-series PCs* 108  
 operands: *C-series PCs* 86  
 previous occurrence: *Basics* 41  
 program addresses: *C-series PCs* 82  
 specified instruction: *C-series PCs* 84  
 summary of operations: *C-series PCs* 89

set values, changing: *CVM1 PCs* 259; *C-series PCs* 260

settings  
*See also* PC Setup; System Setup  
 PC Setup: *C-series PCs* 188  
 PROM Writer: *C-series PCs* 165  
 startup mode: *C-series PCs* 190

Slave Racks  
 C200H/C200HS: *C-series PCs* 132  
 I/O tables: *C-series PCs* 131

software, requirements: *Basics* 4

software switches

CPU SIOU Units: *CVM1 PCs* 428

settings  
 SYSMAC BUS/2 Masters: *CVM1 PCs* 427  
 SYSMAC LINK: *CVM1 PCs* 426  
 SYSMAC NET: *CVM1 PCs* 426

Special I/O Unit Area: *C-series PCs* 200

special instructions  
 displaying: *Basics* 40  
 ladder diagrams: *C-series PCs* 27

starting, SSS: *Basics* 19

startup mode, PC Setup: *C-series PCs* 188

stopping, SSS: *Basics* 19

storing  
 illegal instruction blocks: *C-series PCs* 66  
 ladder diagrams: *C-series PCs* 65  
 Store: *CVM1 PCs* 64; *C-series PCs* 65  
 Store Insert: *CVM1 PCs* 64; *C-series PCs* 65

SV, inputting: *Basics* 67

SYSMAC BUS/2, support: *CVM1 PCs* 351

SYSMAC BUS/2 Remote I/O System  
 communication cycle time: *CVM1 PCs* 424  
 communication error process: *CVM1 PCs* 423  
 error check: *CVM1 PCs* 423  
 hardware checks: *CVM1 PCs* 424  
 response monitor time: *CVM1 PCs* 424  
 transfer error count: *CVM1 PCs* 424

SYSMAC BUS/2 support  
 activating Slaves: *CVM1 PCs* 449  
 displaying status: *CVM1 PCs* 445  
 inactivating Slaves: *CVM1 PCs* 449  
 line mode: *CVM1 PCs* 450  
 reading cycle time: *CVM1 PCs* 447  
 Slave connection status: *CVM1 PCs* 448  
 testing: *CVM1 PCs* 446

SYSMAC LINK  
 connecting to computer: *Basics* 109, 110  
 data link tables – offline: *C-series PCs* 355  
 data link tables – online: *C-series PCs* 363  
 system setup parameters: *Basics* 110

SYSMAC LINK data link tables  
 checking: *CVM1 PCs* 375  
 clearing: *CVM1 PCs* 378, 390  
 communication cycle time: *CVM1 PCs* 395  
 comparing: *CVM1 PCs* 387  
 copying: *CVM1 PCs* 377  
 downloading: *CVM1 PCs* 385  
 editing: *CVM1 PCs* 373  
 error message table  
 common link parameter: *CVM1 PCs* 376  
 refresh parameter: *CVM1 PCs* 377  
 monitoring status: *CVM1 PCs* 393

node refresh parameter screen: *CVMI PCs* 371, 372  
 parameter ranges: *CVMI PCs* 375  
 printing: *CVMI PCs* 379  
 refresh cycle time: *CVMI PCs* 395  
 retrieving: *CVMI PCs* 379, 382  
 saving: *CVMI PCs* 378, 391  
 starting and stopping: *CVMI PCs* 392  
 transferring: *CVMI PCs* 382  
 uploading: *CVMI PCs* 383

**SYSMAC LINK Systems**

data link areas: *CVMI PCs* 421  
 number of words: *CVMI PCs* 421  
 setting polled or polling: *CVMI PCs* 421

**SYSMAC NET: Basics 102**

addresses: *Basics* 18  
 communications driver: *Basics* 4  
 connecting computer: *Basics* 107  
 connecting to PC: *Basics* 20  
 installation: *Basics* 15, 18  
 models: *Basics* 105

**SYSMAC NET data link tables**

comparing: *CVMI PCs* 363  
 downloading: *CVMI PCs* 363  
 monitoring status: *CVMI PCs* 366  
 saving: *CVMI PCs* 364  
 starting and stopping: *CVMI PCs* 365  
 uploading: *CVMI PCs* 362

**SYSMAC NET Link Systems**

Binary and ASCII: *CVMI PCs* 419  
 data link areas: *CVMI PCs* 419  
 datagram format: *CVMI PCs* 419  
 Master and Slave: *CVMI PCs* 419  
 number of words: *CVMI PCs* 419  
 transfer delay time: *CVMI PCs* 419

**System Setup: Basics 49**

PC interface: *Basics* 20, 23

**system setup**

CPU SIOU Units: *CVMI PCs* 427  
 menu: *C-series PCs* 206

**T**

**testing**

SYSMAC LINK: *CVMI PCs* 436  
 broadcast test: *CVMI PCs* 437  
 internode test: *CVMI PCs* 437  
 network parameters: *CVMI PCs* 440  
 node status: *CVMI PCs* 439  
 unit error history: *CVMI PCs* 441  
 SYSMAC NET: *CVMI PCs* 432  
 internode test: *CVMI PCs* 433  
 node status: *CVMI PCs* 434  
 unit error history: *CVMI PCs* 435

**TIM**

changing: *CVMI PCs* 140, 144  
 changing operands: *C-series PCs* 150

TIM numbers, changing: *C-series PCs* 150

**time chart monitor data**

displaying: *C-series PCs* 178  
 retrieving: *C-series PCs* 178  
 saving: *C-series PCs* 178

time chart monitoring: *C-series PCs* 323

reading chart data: *C-series PCs* 326  
 retrieving chart data from floppy disk: *C-series PCs* 326  
 saving chart data on floppy disk: *C-series PCs* 327

timer instructions, ladder diagrams: *C-series PCs* 25

**timers**

changing SV: *CVMI PCs* 259; *C-series PCs* 246, 260  
 inputting: *Basics* 67

**tracing**

data trace: *C-series PCs* 179  
 instructions: *C-series PCs* 179

**transferring**

expansion instructions: *C-series PCs* 187  
 I/O table to UM: *C-series PCs* 211  
 programs: *Basics* 79

typed mnemonics, mnemonic programming: *C-series PCs* 104

typing mnemonics, mnemonic programming: *C-series PCs* 105

**U**

**UM**

clearing partial protection: *CVMI PCs* 346  
 clearing total protection: *CVMI PCs* 346  
 protecting: *CVMI PCs* 344

**UM area**

allocation: *C-series PCs* 199  
 converting to ROM: *C-series PCs* 201

**uploading**

custom data areas: *CVMI PCs* 340  
 routing tables: *CVMI PCs* 409  
 SYSMAC LINK data link tables: *CVMI PCs* 383  
 SYSMAC NET data link tables: *CVMI PCs* 362

**utility programs**

changing: *CVMI PCs* 243; *C-series PCs* 235  
 deleting: *CVMI PCs* 242; *C-series PCs* 234  
 registering: *CVMI PCs* 240; *C-series PCs* 232  
 starting: *CVMI PCs* 244; *C-series PCs* 236

**V**

VDISK.SYS: *Basics* 9

verifying programs, EPROM: *C-series PCs* 171

## W

watch cycle time: *CVM1 PCs* 190

*See also* cycle time monitoring time

wiring, RS-232C connectors: *Basics* 24

### word addresses

changing: *CVM1 PCs* 145, 146; *C-series PCs* 152

changing word and bit addresses together: *C-series PCs* 155

entering: *CVM1 PCs* 26; *C-series PCs* 22

ladder diagrams: *C-series PCs* 22

mnemonic programming: *C-series PCs* 105

range, changing: *C-series PCs* 153

word grouping: *CVM1 PCs* 213

### words

checking: *C-series PCs* 147, 148

specifying: *C-series PCs* 273

write mode: *C-series PCs* 43, 63, 107

function keys: *CVM1 PCs* 63; *C-series PCs* 64

operations: *C-series PCs* 63

summary of operations: *CVM1 PCs* 62; *C-series PCs* 63

### writing

DM: *C-series PCs* 114

EPROM: *C-series PCs* 167

I/O comments: *C-series PCs* 95

multiple addresses: *C-series PCs* 99

I/O tables: *C-series PCs* 131

line connections: *C-series PCs* 30

mnemonic programming: *C-series PCs* 106

## Revision History

A manual revision code appears as a suffix to the catalog number on the front cover of the manual.

Cat. No. W248-E1-2

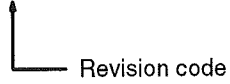

The following table outlines the changes made to the manual during each revision. Page numbers refer to the previous version.

| Revision code | Date         | Revised content   |
|---------------|--------------|---|
| 1             | January 1995 | Original production   |
| 2             | June 1996    | Contents revised to reflect the upgrade to Version 1.13 and addition of the C200HX/HG/HE PCs.<br>A section on the new Option Menu was added as section 8. |









**OMRON Corporation**  
Systems Components Division  
66 Matsumoto  
Mishima-city, Shizuoka 411-8511  
Japan  
Tel: (81)559-77-9633/Fax: (81)559-77-9097

**Regional Headquarters**

**OMRON EUROPE B.V.**  
Wegalaan 67-69, NL-2132 JD Hoofddorp  
The Netherlands  
Tel: (31)2356-81-300/Fax: (31)2356-81-388

**OMRON ELECTRONICS, INC.**  
1 East Commerce Drive, Schaumburg, IL 60173  
U.S.A.  
Tel: (1)847-843-7900/Fax: (1)847-843-8568

**OMRON ASIA PACIFIC PTE. LTD.**  
83 Clemenceau Avenue,  
#11-01, UE Square,  
Singapore 239920  
Tel: (65)835-3011/Fax: (65)835-2711

# OMRON

**Authorized Distributor:**