

**OMRON**

**G3PW**  
**Power Controllers**

**User's Manual**

Cat. No. Z280-E1-08



# **G3PW**

# **Power Controllers**

## **User's Manual**

*Revised June 2023*



## **Preface**

This manual describes the G3PW Power Controllers, including information on functions, performance, and application methods. Observe the following precautions in using the G3PW.

- Allow only a specialists with sufficient knowledge of electrical systems to handle the G3PW.
- Read this manual thoroughly, be sure you understand the contents, and use the G3PW correctly.
- Keep this manual in a safe location where it will be readily available when needed.
- Some of function and parameter are added at Ver 1.1 compared with Ver 1.0.

## **Visual Aids**

The following headings appear in the left column of the manual to help you locate different types of information.

**Note** Indicates information of particular interest for efficient and convenient operation of the product.

**1,2,3...** 1. Indicates lists of one sort or another, such as procedures, checklists, etc.

### **© OMRON, 2008-2023**

All rights reserved. No part of this publication may be reproduced, stored in a retrieval system, or transmitted, in any form, or by any means, mechanical, electronic, photocopying, recording, or otherwise, without the prior written permission of OMRON.

No patent liability is assumed with respect to the use of the information contained herein. Moreover, because OMRON is constantly striving to improve its high-quality products, the information contained in this manual is subject to change without notice. Every precaution has been taken in the preparation of this manual. Nevertheless, OMRON assumes no responsibility for errors or omissions. Neither is any liability assumed for damages resulting from the use of the information contained in this publication.

# ***Terms and Conditions Agreement***

## ***Warranty, Limitations of Liability***

### **Warranties**

#### **● Exclusive Warranty**

Omron's exclusive warranty is that the Products will be free from defects in materials and workmanship for a period of twelve months from the date of sale by Omron (or such other period expressed in writing by Omron). Omron disclaims all other warranties, express or implied.

#### **● Limitations**

OMRON MAKES NO WARRANTY OR REPRESENTATION, EXPRESS OR IMPLIED, ABOUT NON-INFRINGEMENT, MERCHANTABILITY OR FITNESS FOR A PARTICULAR PURPOSE OF THE PRODUCTS. BUYER ACKNOWLEDGES THAT IT ALONE HAS DETERMINED THAT THE PRODUCTS WILL SUITABLY MEET THE REQUIREMENTS OF THEIR INTENDED USE.

Omron further disclaims all warranties and responsibility of any type for claims or expenses based on infringement by the Products or otherwise of any intellectual property right.

#### **● Buyer Remedy**

Omron's sole obligation hereunder shall be, at Omron's election, to (i) replace (in the form originally shipped with Buyer responsible for labor charges for removal or replacement thereof) the non-complying Product, (ii) repair the non-complying Product, or (iii) repay or credit Buyer an amount equal to the purchase price of the non-complying Product; provided that in no event shall Omron be responsible for warranty, repair, indemnity or any other claims or expenses regarding the Products unless Omron's analysis confirms that the Products were properly handled, stored, installed and maintained and not subject to contamination, abuse, misuse or inappropriate modification. Return of any Products by Buyer must be approved in writing by Omron before shipment. Omron Companies shall not be liable for the suitability or unsuitability or the results from the use of Products in combination with any electrical or electronic components, circuits, system assemblies or any other materials or substances or environments. Any advice, recommendations or information given orally or in writing, are not to be construed as an amendment or addition to the above warranty.

See <http://www.omron.com/global/> or contact your Omron representative for published information.

### **Limitation on Liability; Etc**

OMRON COMPANIES SHALL NOT BE LIABLE FOR SPECIAL, INDIRECT, INCIDENTAL, OR CONSEQUENTIAL DAMAGES, LOSS OF PROFITS OR PRODUCTION OR COMMERCIAL LOSS IN ANY WAY CONNECTED WITH THE PRODUCTS, WHETHER SUCH CLAIM IS BASED IN CONTRACT, WARRANTY, NEGLIGENCE OR STRICT LIABILITY.

Further, in no event shall liability of Omron Companies exceed the individual price of the Product on which liability is asserted.

# ***Application Considerations***

## **Suitability of Use**

Omron Companies shall not be responsible for conformity with any standards, codes or regulations which apply to the combination of the Product in the Buyer's application or use of the Product. At Buyer's request, Omron will provide applicable third party certification documents identifying ratings and limitations of use which apply to the Product. This information by itself is not sufficient for a complete determination of the suitability of the Product in combination with the end product, machine, system, or other application or use. Buyer shall be solely responsible for determining appropriateness of the particular Product with respect to Buyer's application, product or system. Buyer shall take application responsibility in all cases.

NEVER USE THE PRODUCT FOR AN APPLICATION INVOLVING SERIOUS RISK TO LIFE OR PROPERTY OR IN LARGE QUANTITIES WITHOUT ENSURING THAT THE SYSTEM AS A WHOLE HAS BEEN DESIGNED TO ADDRESS THE RISKS, AND THAT THE OMRON PRODUCT(S) IS PROPERLY RATED AND INSTALLED FOR THE INTENDED USE WITHIN THE OVERALL EQUIPMENT OR SYSTEM.

## **Programmable Products**

Omron Companies shall not be responsible for the user's programming of a programmable Product, or any consequence thereof.

## ***Disclaimers***

### **Performance Data**

Data presented in Omron Company websites, catalogs and other materials is provided as a guide for the user in determining suitability and does not constitute a warranty. It may represent the result of Omron's test conditions, and the user must correlate it to actual application requirements. Actual performance is subject to the Omron's Warranty and Limitations of Liability.

### **Change in Specifications**

Product specifications and accessories may be changed at any time based on improvements and other reasons. It is our practice to change part numbers when published ratings or features are changed, or when significant construction changes are made. However, some specifications of the Product may be changed without any notice. When in doubt, special part numbers may be assigned to fix or establish key specifications for your application. Please consult with your Omron's representative at any time to confirm actual specifications of purchased Product.

### **Errors and Omissions**

Information presented by Omron Companies has been checked and is believed to be accurate; however, no responsibility is assumed for clerical, typographical or proofreading errors or omissions.

## ■ Definition of Precautionary Information

The following notation is used in this manual to provide precautions required to ensure safe usage of the product.





The safety precautions that are provided are extremely important to safety. Always read and heed the information provided in all safety precautions.

The following notation is used.

 <b>WARNING</b>	Indicates a potentially hazardous situation which, if not avoided, could result in death or serious injury. Additionally, there may be severe property damage.
--	--







 <b>CAUTION</b>	Indicates a potentially hazardous situation which, if not avoided, is likely to result in minor or moderate injury or in property damage.
--	---

## ■ Symbols





	The circle and slash symbol indicates operations that you must not do. The specific operation is shown in the circle and explained in text.
	The triangle symbol indicates precautions (including warnings). The specific operation is shown in the triangle and explained in text. This example indicates a precaution for electric shock.
	The triangle symbol indicates precautions (including warnings). The specific operation is shown in the triangle and explained in text. This example indicates a precaution for hot surfaces.
	The triangle symbol indicates precautions (including warnings). The specific operation is shown in the triangle and explained in text. This example indicates a general precaution.
	The filled circle symbol indicates operations that you must do. The specific operation is shown in the circle and explained in text. This example shows a general precaution for something that you must do.



## ■ Safety Precautions

 <b>WARNING</b>	
Do not attempt to disassemble the Power Controller while the power is being supplied. Doing so may occasionally result in strong electric shock.	
Do not touch any of the terminals while the power is being supplied. Also, always attach the terminal block cover after completing wiring. Touching live terminals may occasionally result in serious injury due to electric shock.	
Fail-safe measures must be taken by the customer to ensure safety in the event of incorrect, missing, or abnormal signals caused by broken signal lines, momentary power interruptions, or other causes. Abnormal operation may result in serious accidents.	
Do not use the Power Controller where subject to flammable or explosive gas. Otherwise, explosion may occur.	
Use the wire sizes given in this document and use twisted copper wires or solid copper wire. Use crimp terminals with insulative sleeves. If the crimp terminals do not come with insulative sleeves, attach insulative sleeves. Use the size of crimp terminals specified in this document.	
Make sure that the phases match for load terminal T1 and power supply terminal 4 (N), and for load terminal L1 and power supply terminal 5 (L). Insert suitable fuses in the power supply line and load output line to protect the circuits. The Power Controller will not operate normally if the wiring is not correct, and the load may be damaged.	
Leave at least 100 mm of space above and below the Power Controller when installing it to allow heat to dissipate. Do not obstruct the area around the Power Controller and especially the area around the heat sink.	
Install the Power Controller in the direction shown in this Instruction Sheet. The Power Controller generates a lot of heat and it uses natural heat convection for cooling. Installing the Power Controller in the wrong direction may cause in malfunctions or accidents.	

## ⚠ CAUTION

<p>The Power Controller and the heat sink become very hot. Do not touch anything but the setting keys while power is being supplied or just after the power supply is turned OFF. Doing so may cause burns.</p>	
<p>Do not attempt to disassemble, modify, or repair the Power Controller or touch any of the internal parts. Minor electric shock, fire, or malfunction may occasionally occur.</p>	
<p>Do not allow chips or filings from installation work, pieces of metal, or wire clippings to enter the Power Controller. Doing so may occasionally result in minor electric shock, fire, or malfunction.</p>	
<p>Always connect the load to load terminal T1. Also, always connect power supply terminal 4 (N) directly to the power supply. Do not connect it through the load. If the wiring is not correct, the fault detection function of the Power Controller will stop the output operation.</p>	
<p>When using the Power Controller to control the primary side of a transformer, do not open the circuit on the secondary side of the transformer while the Power Controller is operating.</p>	
<p>Do not touch the connecting cables while power is being supplied. Static electricity from your body may cause malfunctioning.</p>	
<p>If a malfunction in the Power Controller prevents control operations or if an alarm cannot be output, it may occasionally cause damage to the connected equipment and devices. To maintain safety in the event of a malfunction in the Power Controller, always take appropriate safety measures, such as installing a separate monitoring system.</p>	
<p>Set the parameters of the Power Controller so that they are suitable for the system being controlled. If they are not suitable, unexpected operation may occasionally result in property damage or accidents.</p>	
<p>Tighten the terminal screws to the torque specified in this Instruction Sheet. If the screws are loose, it may occasionally cause a fire.</p>	

Take adequate security measures against DDoS attacks (Distributed Denial of Service attacks), computer viruses and other technologically harmful programs, unauthorized access and other possible attacks before using this product.

## ■ Security Measures

<p><b>Anti-virus protection</b> Install the latest commercial-quality antivirus software on the computer connected to the control/monitor system and maintain to keep the software up-to-date.</p>	
<p><b>Security measures to prevent unauthorized access</b> Take the following measures to prevent unauthorized access to our products.</p> <ul style="list-style-type: none"> <li>• Install physical controls so that only authorized personnel can access control/monitor systems and equipment.</li> <li>• Reduce connections to control/monitor systems and equipment via networks to prevent access from untrusted devices.</li> <li>• Install firewalls to shut down unused communications ports and limit communications hosts and isolate control/monitor systems and equipment from the IT network.</li> <li>• Use a virtual private network (VPN) for remote access to control/monitor systems and equipment.</li> <li>• Scan virus to ensure safety of SD cards or other external storages before connecting them to control/monitor systems and equipment.</li> </ul>	
<p><b>Data input and output protection</b> Validate backups and ranges to cope with unintentional modification of input/output data to control/monitor systems and equipment.</p> <ul style="list-style-type: none"> <li>• Checking the scope of data</li> <li>• Checking validity of backups and preparing data for restore in case of falsification and abnormalities</li> <li>• Safety design, such as emergency shutdown, in case of data tampering and abnormalities</li> </ul>	
<p><b>Data recovery</b> Backup data and keep the data up-to-date periodically to prepare for data loss.</p>	

## Precautions for Safe Use

### ● Installation Environment

- Use the Power Controller within the rated ambient temperature and humidity ranges. If multiple Power Controllers are installed side-by-side or vertically, the heat that is generated will cause the internal temperatures of the Power Controllers to rise and will shorten their service life. In these kinds of installations, take suitable measures, such as installing fans for forced cooling.
- The Power Controller is designed for indoor use only. Also, do not use the Power Controller in the following environments.
  - Locations subject to water, oil, or chemicals
  - Locations subject to direct sunlight
  - Locations where dust or corrosive gases (in particular, sulfuric or ammonia gas) are present
  - Locations subject to extreme temperature changes
  - Locations where icing or condensation may occur
  - Locations subject to excessive shocks or vibration
  - Locations subject to direct heat radiated from heating devices

### ● Installation and Wiring

- When installing the Power Controller, always securely tighten the top mounting screws first. When removing the Power Controller, always remove the bottom mounting screws first.
- Take safety measures, such as wearing safety shoes, in case the Power Controller falls.
- Touch the Power Controller only after first touching a grounded metal object to discharge any static electricity from your body.
- Always ground the Power Controller to 100  $\Omega$  or less. There are no ground terminals provided, so use the heat sink mounting screws as ground terminals.
- Check the terminal number and polarity for each input before connecting it.
- Use copper twisted wire in the sizes specified in this Instruction Sheet.
- Use insulated crimp terminals with insulation sleeves. If using crimp terminals that are not insulated, cover them with insulation sleeves. Also, use terminals of the sizes specified in this Instruction Sheet.
- Insert connectors all the way.
- Do not connect anything to unused terminals.

### ● Safety Measures and Checking

- Install a switch or circuit breaker so that the operator can immediately turn OFF the power, and provide a suitable display.
- Apply the power supply voltage through the contacts of a switch, relay, or similar device so it reaches the rated voltage within 2 s. If the voltage is increased gradually, the power supply may not be reset or outputs may malfunction.
- Use a power supply voltage, input voltage, input current, and load within the specifications and rated ranges for the Power Controller. Use a load that draws a current at the maximum output that is within the rated current range of the Power Controller. If the current drawn by the load is not within the rated current range, malfunction or fire may occur.
- To prevent electric shock, damage, or malfunction, complete all the wiring before turning ON the power.
- Make sure that the protective cover is attached to the load terminal block before using the Power Controller. Failure to do so may damage internal components due to mechanical stress.

### ● Preventing Inductive Noise

- Install a switch or circuit breaker so that the operator can immediately turn OFF the power, and provide a suitable display.
- Apply the power supply voltage through the contacts of a switch, relay, or similar device so it reaches the rated voltage within 2 s. If the power supply voltage is increased gradually, the power supply may not be reset or outputs may malfunction.

- Use a power supply voltage, input voltage, input current, and load within the specifications and rated ranges for the Power Controller. Use a load that draws a current at the maximum output that is within the rated current range of the Power Controller. If the current drawn by the load is not within the rated current range, malfunction or fire may occur.
- Make sure that the protective cover is attached to the load terminal block before using the Power Controller. Failure to do so may damage internal components due to mechanical stress.

### ● Preventing Inductive Noise

- Allow as much space as possible between the Power Controller and devices that generate powerful high frequencies (high-frequency welders, high-frequency sewing machines, etc.) or surge.
- Keep the signal lines that connect to the Power Controller's terminal block away from power cables carrying high voltages or large currents. Also, do not wire power lines together with or parallel to Power Controller wiring. Using shielded cables and using separate conduits or ducts is recommended.
- Attach a surge suppressor or noise filter to peripheral devices that generate noise (in particular, motors, transformers, solenoids, magnetic coils or other equipment that have an inductance component).
- When a noise filter is used at the power supply, first check the voltage or current, and attach the noise filter as close as possible to the Power Controller.

### ● Cleaning

- Do not use paint thinner or similar chemical to clean with. Use commercially available standard grade alcohol.

### ● Storage

- Store the Power Controller within the rated ambient temperature.



# TABLE OF CONTENTS

## SECTION 1

<b>Overview</b> .....	<b>1</b>
1-1 Overview of G3PW Power Controller .....	2
1-2 G3PW Features .....	3
1-3 I/O Block Diagram .....	5
1-4 Models and Specifications .....	6

## SECTION 2

<b>Specifications and Nomenclature</b> .....	<b>7</b>
2-1 Specifications .....	8
2-2 Nomenclature and Operations .....	14

## SECTION 3

<b>Installation and Wiring</b> .....	<b>17</b>
3-1 Installation Environment .....	18
3-2 Installation .....	21
3-3 Wiring .....	26
3-4 Wiring for Specific Applications .....	33

## SECTION 4

<b>Control Methods and I/O Configuration</b> .....	<b>35</b>
4-1 Control Methods .....	36
4-2 Output Modes .....	37
4-3 Monitored Items .....	38
4-4 Input System .....	39
4-5 Procedures for Operation and Setting Parameters .....	41
4-6 Setting Parameters in the Initial Setting Level .....	44

## SECTION 5

<b>Descriptions of Functions</b> .....	<b>49</b>
5-1 External Contact Input Functions .....	50
5-2 Inputting the Main Setting with an External Variable Resistor .....	53
5-3 Duty Setting .....	54
5-4 Base-up Function .....	56
5-5 Output Limits .....	57
5-6 Soft-start Up and Soft-start Down Functions .....	58
5-7 Load Current Limit (Constant-current Models Only) .....	59
5-8 Monitoring Total Run Time .....	60
5-9 Heater Burnout Detection (Constant-current Models Only) .....	61

## SECTION 6

<b>CompoWay/F Communications</b> .....	<b>67</b>
--	-----------

# TABLE OF CONTENTS

6-1	Communications Settings .....	68
6-2	Frame Configuration .....	77
6-3	FINS-mini Text .....	79
6-4	Services and Addresses .....	80
6-5	Variable Area Write .....	84
6-6	Variable Area Read .....	85
6-7	Operation Command .....	88
6-8	Controller Attribute Read .....	89
6-9	Controller Status Read .....	90
6-10	Echo-back Test .....	91
6-11	ASCII Table .....	92
 <b>SECTION 7</b>		
<b>Error Processing .....</b>		<b>93</b>
7-1	Checking Possible Errors .....	94
7-2	Error Displays .....	95
7-3	Detailed Descriptions of Errors .....	97
 <b>Appendices</b>		
<b>Parameters Set in Initial Setting Level .....</b>		<b>101</b>
A	Parameter Settings in the Adjustment Level .....	105
 <b>Index .....</b>		<b>107</b>
 <b>Revision History .....</b>		<b>111</b>



## ***About this Manual:***

This manual describes the G3PW Power Controllers and includes the sections described below. Please read this manual carefully and be sure you understand the information provided before attempting to set up or operate a G3PW Power Controllers.

**Section 1** provides an overview of the G3PW Power Controllers.

**Section 2** provides the specifications of the G3PW Power Controllers and describes the part names and functions.

**Section 3** describes how to install and wire the G3PW Power Controllers.

**Section 4** describes the control methods that you can use, the I/O configuration, and how to set parameters for the G3PW Power Controllers.

**Section 5** describes the functions you can use when operating the G3PW Power Controllers.

**Section 6** provides information on using CompoWay/F communications.

**Section 7** provides troubleshooting information.

The **Appendices** provide lists of the parameters in the initial setting level and the adjustment level.



**WARNING** Failure to read and understand the information provided in this manual may result in personal injury or death, damage to the product, or product failure. Please read each section in its entirety and be sure you understand the information provided in the section and related sections before attempting any of the procedures or operations given.



# SECTION 1

## Overview

This section provides an overview of the G3PW Power Controllers.

1-1	Overview of G3PW Power Controller .....	2
1-2	G3PW Features .....	3
1-2-1	Features of Constant-current and Standard Models .....	3
1-2-2	Features of Constant-current Models Only .....	3
1-3	I/O Block Diagram .....	5
1-4	Models and Specifications .....	6

## 1-1 Overview of G3PW Power Controller

The G3PW Power Controller is a thyristor-type single-phase power controller that enables precise temperature control. It accepts a continuous proportional output of 4 to 20 mA or 1 to 5 V from a temperature controller to execute phase control or optimum cycle control.

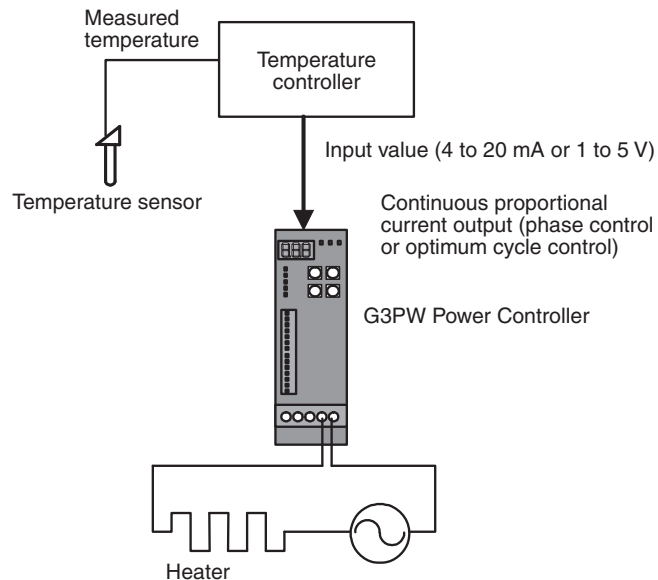

Just as with a solid state relay (SSR), ON/OFF control can be executed by inputting a time-proportional output or 5 V DC ON/OFF output (i.e., voltage ON/OFF signals) from a temperature controller.

Initial settings (output mode, input signal type, event input settings, etc.) and adjustments (duty settings, soft-start up/down settings, etc.) can be made by using keys on the front panel. The 7-segment display on the front panel can also be used to monitor items such as the input value (%), output value (%), phase angle (%), and load current (A) (see note).

**Note** Constant-current Models only.

G3PW Power Controllers come in two models: Constant-current Models and Standard Models. Constant-current Models provide current detection functions (constant current, current limit, overcurrent detection, and heater burnout detection) and serial communications (including connections to the EJ1 Modular Temperature Controller). Heater burnout detection is based on the heater resistance rather than on the load current, making detection more accurate.

## 1-2 G3PW Features

### 1-2-1 Features of Constant-current and Standard Models

Phase control or optimum cycle control can be selected by using either event inputs or the keys on the front panel. Inrush current can be suppressed by selecting phase control with the soft-start up/down functions at startup and high-frequency noise can be suppressed by switching to optimum cycle control when in a steady state.

#### **A Wide Selection of Output Modes Is Available for Phase Control**

With phase control, any of the following modes can be selected for the input signal or external setting: a mode with the output proportional to the phase angle, a mode with the output proportional to the voltage, a mode with the output proportional to the square of the voltage (i.e., the power), or a mode with the output proportional to the current (constant current mode, see note).

**Note** Constant-current Models only.

#### **Soft-start Up and Soft-start Down Functions**

The soft-start up and soft-start down functions are used to change the output value gradually within a set rate of change, even when the input value changes suddenly. You can set the time for the output value to go from 0% to 100% or from 100% to 0% to 0.0 to 99.9 s.

#### **Duty Setting**

The duty setting is used to set the rate of change from 0% to 100% of the output value in relation to the input value.

#### **Base-up Function**

The base-up function increases the output value so that the output value does not go to 0% even when the input value is 0%. This enables preheating the heater even at an input value of 0%, which is effective when using a load for which the heater temperature increases slowly.

#### **Output Limit**

The output limit is used to set upper and lower limits for the output value. Instead of adjusting the rate of change of the output value in relation to the input value, it enables upper and lower limits to be set on the current flowing to the heater.

#### **Total Run Time Exceeded Detection**

The total run time exceeded detection function outputs an alarm when the total run time exceeds the preset Total Run Time Monitor value (kh). The total run time can be monitored for notification of the need for replacement or preventive maintenance of the Power Controller or heater.

### 1-2-2 Features of Constant-current Models Only

#### **Constant-current Control for Controlling a Pure Metal or Nonmetal Heater**

Constant-current control measures the load current with a built-in CT, and controls the load current so that it is proportional to the input. This stabilizes the heating values of heaters (pure metal or nonmetal) for which the resistance changes due to temperature changes or deterioration over time.

#### **Current Limit for the Load Current**

The current limit function measures the load current with a built-in CT and protects the heater by adjusting the phase angle to limit the load current so that a preset load current limit is not exceeded. It is also used together with the soft-start functions to limit the inrush current for pure-metal heaters and nonmetal heaters.

### Heater Burnout Detection and Alarm Based on Heater Resistance

This function detects changes in heater resistance. An alarm is output if a change exceeds the set value. The Controller can be set to stop or hold the output status when an alarm occurs.

With previous heater burnout detection functions, heater burnout was determined based on the rate of change of the electric current flowing to the heater. The command value and the load current do not have a linear relationship, so faulty detection can occur when the command value is changed. With the G3PW Power Controllers, heater burnout is determined based on the rate of change of the heater resistance, enabling more accurate heater burnout detection when the command value changes.

### Serial Control from an EJ1 Modular Temperature Controller

Up to eight G3PW Power Controllers can be connected to a Basic Unit in an EJ1 Modular Temperature Controller via RS-485. Using multiple Power Controllers enables a wire-saving temperature control system.

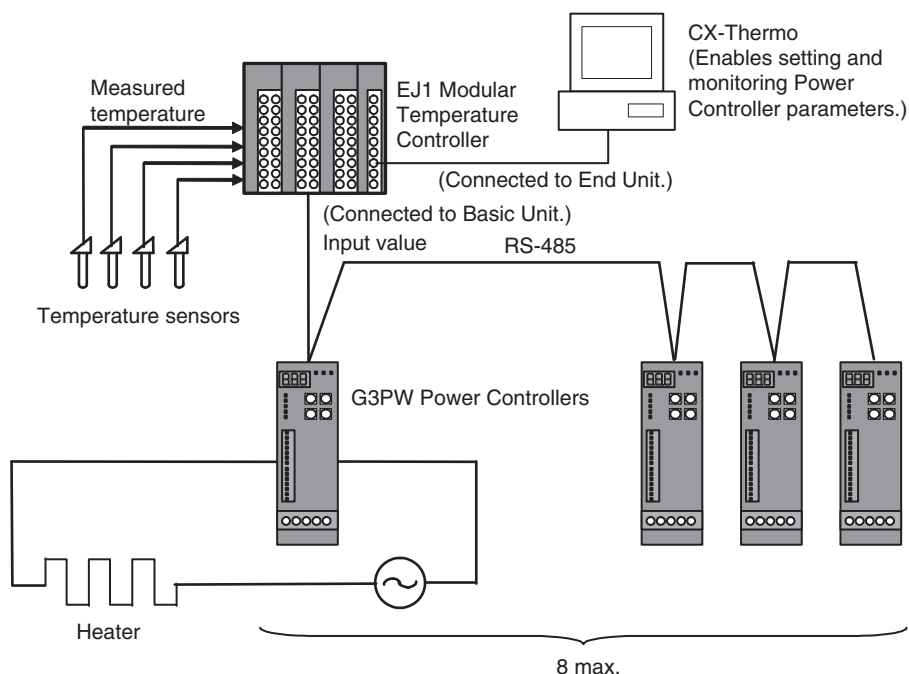

Power Controller parameters can be set and monitored, and the control status of items such as the load current can be monitored from CX-Thermo Support Software running on a personal computer that is connected to the EJ1 End Unit. For details, refer to the *EJ1 Modular Temperature Controller User's Manual* (Cat. No. H142).

# 1-3 I/O Block Diagram

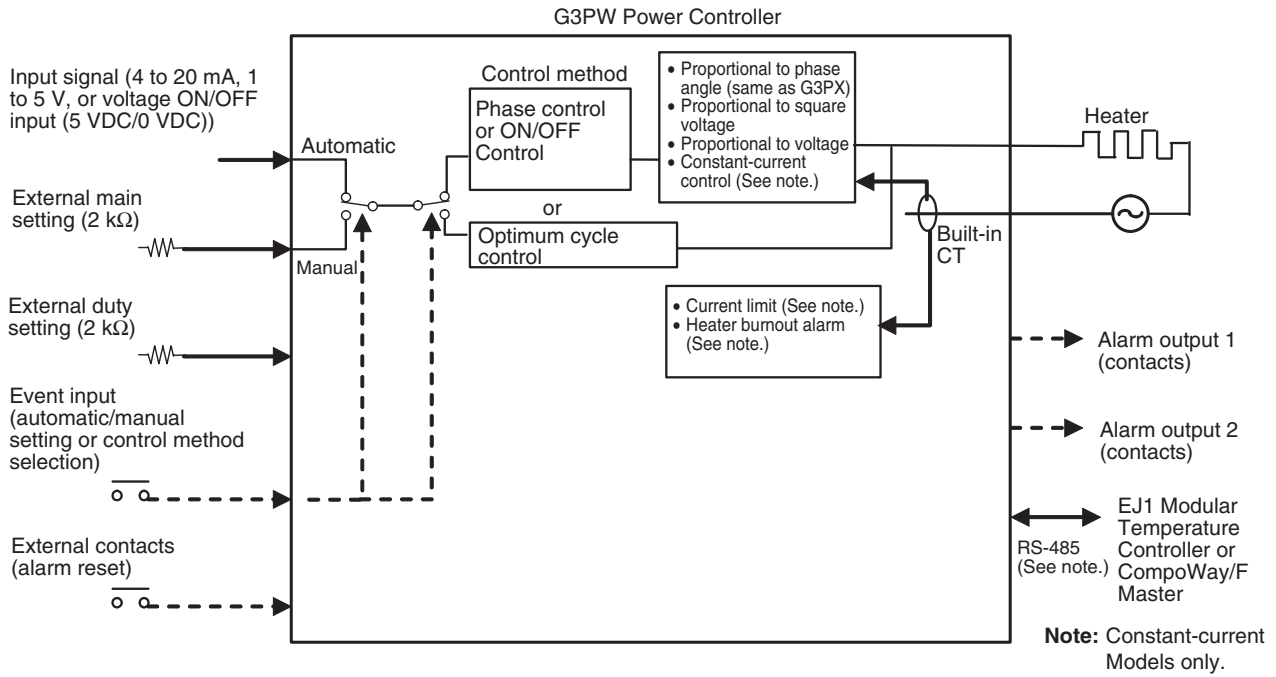

### 1-4 Models and Specifications

**G3PW-A2**  **E** **-** **-**     
1
2 3
4
5 6
7
8

Number	Item	Symbol	Meaning of symbol
1	Basic model	G3PW	Power Controller
2	Degree of protection	A	IP00
3	Voltage class	2	200 VAC
4	Maximum rated current	20	20 A
		45	45 A
		60	60 A
5	Power supply type	E	Single-phase power supply
6	Current control	U	Standard Model (no constant-current control)
		C	Constant-current Model
7	Control terminal block	S	Terminal block with small slotted screws
		C	Screwless clamp terminal block
8	RS-485 communications	Blank	Communications not supported.
		FLK	Communications supported.

#### List of Models

Number of phases	Control terminal block	Type	Capacity	Model number
Single-phase	Terminal block with small slotted screws	Standard	20 A	G3PW-A220EU-S
			45 A	G3PW-A245EU-S
			60 A	G3PW-A260EU-S
		Constant current	20 A	G3PW-A220EC-S-FLK
			45 A	G3PW-A245EC-S-FLK
			60 A	G3PW-A260EC-S-FLK
	Screwless clamp terminal block	Standard	20 A	G3PW-A220EU-C
			45 A	G3PW-A245EU-C
			60 A	G3PW-A260EU-C
		Constant current	20 A	G3PW-A220EC-C-FLK
			45 A	G3PW-A245EC-C-FLK
			60 A	G3PW-A260EC-C-FLK

#### Optional Products

Name	Model
Variable Resistor	G32X-V2K (specified model)



## **SECTION 2**

# **Specifications and Nomenclature**

This section provides the specifications of the G3PW Power Controllers and describes the part names and functions.

2-1	Specifications .....	8
2-2	Nomenclature and Operations.....	14

## 2-1 Specifications

### Specifications

Item		Standard Models	Constant-current Models
Model		G3PW-A2□□EU-□	G3PW-A2□□EC-□-FLK
Control method		Analog input: Phase control or optimum cycle control Voltage ON/OFF input: ON/OFF control	
Maximum load capacity		<ul style="list-style-type: none"> <li>Phase control: Linear (resistive) load, transformer primary-side control (Magnetic flux density: 1.25 T max.)</li> <li>Optimum cycle control: Linear (resistive) load (Transformer primary-side control is not supported.)</li> </ul>	
Output mode	Analog input	Phase control	Proportional to phase angle (same as G3PX), proportional to square voltage, proportional to voltage
		Optimum cycle control	Proportional to phase angle (same as G3PX), proportional to square voltage, proportional to voltage, constant-current control
	Voltage ON/OFF input	ON/OFF control	Optimum cycle control (Output is switched to 100% or 0% each half cycle.) Proportional to voltage control
Phase		Single	
Rated voltage		100 to 240 VAC	
Operating voltage range		-15% to +10%	
Power supply frequency		50/60 Hz	
Power supply frequency fluctuation		±3 Hz	
Power consumption		5 VA max. (Between terminal 4 and 5; control power supply terminal)	
Load current	-A220E□	1 to 20 A	
	-A245E□	1 to 45 A	
	-A260E□	1 to 60 A	
Inrush current resistance	-A220E□	220 A (60 Hz, 1 cycle)	
	-A245E□	440 A (60 Hz, 1 cycle)	
	-A260E□	440 A (60 Hz, 1 cycle)	
Output voltage adjustable range		0% to 98%	
Input signal for control	Analog input	4 to 20 mA DC (input impedance: 100 Ω) or 1 to 5 VDC (input impedance: 30.1 kΩ)	
	Voltage ON/OFF Input	5 VDC (input impedance: 30.1 kΩ)	
	External main setting	Specified Variable Resistor: G32X-V2K (2 kΩ, 2 W)	
	External duty setting		
Output value setting range	Main setting	0.0 to 100%	
	Base-up value	0.0 to 100% (Default: 0.0%)	
	Upper/ lower limits	Output upper limit: 0.0% to 100% (Default: 100%) Output lower limit: 0.0% to 100% (Default: 0.0%)	
	Duty setting	Duty setting = Internal duty setting x External duty setting Internal duty setting range (set using front-panel keys or communications): 0% to 100% (Default: 100%) External duty setting range (set using external variable resistor): 0% to 100% (Default: 100%)	
Soft-start up time and soft-start down time		0.0 to 99.9 s (Default: 0.5 s) Either phase control or optimum cycle control can be used.	
Constant current		---	Current fluctuation: ±2% FS
Load current upper limit		---	0.0 to 66.0 (Default: 0.0 = OFF) Overcurrent detection time: 500 ms max.
CPU clock frequency		20 MHz	

Item		Standard Models	Constant-current Models
Model		G3PW-A2□□EU-□	G3PW-A2□□EC-□-FLK
Current detection	Current transformer (CT)	---	Built-in
	Current detection accuracy	---	10% FS of rated current At heater burnout detecting
	Minimum detected load current	---	1 A
Heater burnout alarm	Burnout detection accuracy	---	10% FS at rated current (Not applicable to loads with variable resistance.)
	Detection method	---	According to heater resistance (with heater resistance teaching and Heater Burnout Threshold parameter)  <b>Note</b> The accuracy of heater burnout detection will be lower for heaters for which the resistance significantly changes depending on the temperature.
	Setting range for heater burnout detection	---	1% to 100% (Default: 100%)
	Burnout detection output lower limit	---	Detects a burnout at or above the specified output value. 0.0% to 100% (Default: 0.0%)
	Number of alarms for heater burnout detection	---	0 to 999 (Default: 150)
	Multiple heater burnout detections	---	Burnout of 1 of 10 heater elements can be detected (at the rated current).
	Event inputs	Number of event inputs	2 event inputs Event input 1: The function of the event input can be changed with a parameter setting in the initial setting level. The event input can be used for one of the following functions. <ul style="list-style-type: none"> <li>• Switching the main setting between automatic and manual operation.</li> <li>• Switching between phase control and optimum cycle control.</li> </ul> Event input 2: Alarm reset
	Contact input conditions	ON: 1 kΩ max., OFF: 100 kΩ min.	
	Non-contact input conditions	ON residual voltage: 1.0 V max., OFF leakage current: 0.1 mA max.	
	Current flow	Approx. 1.1 mA (per input)	
Alarm outputs	Number of alarm outputs	2 alarm outputs Alarm output 1: ALARM1 (caution) Alarm output 2: ALARM2 (warning) Open-collector outputs (Individual common)	
	Maximum operating voltage	30 VDC	
	Maximum load current	50 mA	
	Maximum residual voltage	1.5 V	
	Maximum leakage current	0.4 mA	

Item	Standard Models	Constant-current Models												
Model	G3PW-A2□□EU-□	G3PW-A2□□EC-□-FLK												
Serial communications	---	One RS-485 port: CompoWay/F slave function (See note.) <b>Note</b> Connection is possible to a Basic Unit in an EJ1 Modular Temperature Controller. Parameters can be set and monitored from the CX-Thermo Support Software running on a computer that is connected to the EJ1 End Unit.												
Overcurrent detection	---	Rated current × 120% min., within 250 cycles												
SSR failure detection	An error is detected within 3 seconds after an SSR failure. • Phase angle range for SSR short-circuit failure detection: 0% to 72% • Phase angle range for SSR open failure detection: 28% to 100%													
Power supply frequency error	Not within 47 to 63 Hz													
Output ON voltage drop	1.6 Vrms (at 10% output on)													
Leakage current	10 mA max. (100/110 VAC), 20 mA max. (200/220 VAC)													
Insulation resistance	100 MΩ min. (at 500 VDC)													
Dielectric strength	2,500 VAC at 50/60 Hz for 1 min between charged parts and non-charged parts													
Vibration resistance	10 to 55 to 10 Hz, 100 m/s <sup>2</sup>													
Shock resistance	300 m/s <sup>2</sup>													
Ambient operating temperature	-15°C to +55°C (with no icing or condensation)													
Ambient operating humidity	5% to 95%													
Storage temperature	-25°C to +65°C (with no icing or condensation)													
Fuses (fuses recommended for external connection)	<table border="1"> <tr> <td rowspan="4">Fast-acting fuses*</td> <td>Super-rapid Fuse (Fuji Electric)</td> <td>Fuse Holder (Fuji Electric)</td> </tr> <tr> <td>For 20 A, CR6L-20/UL</td> <td>CMS-4</td> </tr> <tr> <td>For 45 A, CR6L-50/UL</td> <td></td> </tr> <tr> <td>For 60 A, CR6L-75/UL</td> <td>CMS-5</td> </tr> <tr> <td>Time-delay fuses</td> <td colspan="2">250 VAC, 2 A</td> </tr> </table>		Fast-acting fuses*	Super-rapid Fuse (Fuji Electric)	Fuse Holder (Fuji Electric)	For 20 A, CR6L-20/UL	CMS-4	For 45 A, CR6L-50/UL		For 60 A, CR6L-75/UL	CMS-5	Time-delay fuses	250 VAC, 2 A	
Fast-acting fuses*	Super-rapid Fuse (Fuji Electric)	Fuse Holder (Fuji Electric)												
	For 20 A, CR6L-20/UL	CMS-4												
	For 45 A, CR6L-50/UL													
	For 60 A, CR6L-75/UL	CMS-5												
Time-delay fuses	250 VAC, 2 A													
Weight	G3PW-A220E□-□-□□□: 1.0 kg max. G3PW-A245E□-□-□□□: 1.9 kg max. G3PW-A260E□-□-□□□: 1.9 kg max.													

\* For UL certified products, please inquire separately.

**Serial Communications Specifications (Constant-current Models Only)**

Item	Constant-current Models (G3PW-A2□□EC-□-FLK)
<b>Communications protocol</b>	CompoWay/F Slave
<b>Communications functions</b>	Reading and writing all parameters
<b>Transmission path connections</b>	Multipoint
<b>Communications method</b>	RS-485
<b>Maximum transmission distance</b>	500 m
<b>Number of nodes</b>	31 (Multi-drop connections)
<b>Sync method</b>	Start-stop synchronization
<b>Baud rate</b>	9.6, 19.2, 38.4 or 57.6 kbit/s (Default: 57.6 kbit/s)
<b>Transmission code</b>	ASCII
<b>Data length</b>	7 or 8 bits (Default: 7 bits)
<b>Stop bits</b>	1 or 2 bits (Default: 2 bits)
<b>Parity</b>	Vertical parity (None, even, odd) (Default: Even)
<b>Flow control</b>	None

Comparison with Previous Model (G3PX)

		G3PX							G3PW	
		Simple models		Advanced			Simple models		Advanced	Standard
Model		EUN	EH	EHN	EC	DU	DH	DC	EU	EC
Number of heater phases		Single-phase				3-phase			Single-phase	
Control object		Alloy (nichrome)			Pure metal (Kanthal Super)	Alloy (nichrome)		Pure metal (Kanthal Super)	Alloy (nichrome)	Pure metal (Kanthal Super)
Load voltage	200 V	100/110/200/220 VAC				200/220 VAC			100 to 240 VAC	
	400 V	---								
Load current		1 to 20, 1 to 40, or 1 to 60 A				1 to 20 or 1 to 60 A			1 to 20, 1 to 45, or 1 to 60 A	
Control method	Phase Control	Supported	Supported	Supported	Supported	Supported	Supported	Supported	Supported	Supported
	Optimum cycle control	---	---	---	---	---	---	---	Supported	Supported
Output mode	Proportional to phase angle control	Supported	Supported	Supported	Supported	Supported	Supported	Supported	Supported	Supported
	Proportional to voltage control	---	---	---	---	---	---	---	Supported	Supported
	Proportional to square voltage control	---	---	---	---	---	---	---	Supported	Supported
	Constant-current control (proportional to current)	---	---	---	Supported	---	---	Supported	---	Supported
Input signals from host	Analog input (continuous proportional)	Supported							Supported	Supported
	Voltage ON/OFF input (time-proportional)	Supported							Supported (5 V/0 V input)	Supported (5 V/0 V input)
	External main setting (using external variable resistor)	Supported							Supported	Supported
	Serial communications (RS-485)	---							---	Supported
Selecting automatic or manual for the main setting		Switched by changing connections.							Event input, key operation	Event input, key operation, communications
Duty settings	Internal setting	Supported	Supported	Supported	Supported	Supported	Supported	Supported	Supported (Keys)	Supported (Keys or communications)
	External setting	Supported	Supported	Supported	Supported	Supported	Supported	Supported	Supported	Supported
Functions	Displayed on 7-segment display	---	---	---	---	---	---	---	Supported	Supported
	Level indicators (output display)	Supported	Supported	Supported	Supported	Supported	Supported	Supported	---	---
	Soft-start function	---	Supported	---	---	---	---	---	Supported	Supported
	Long soft-start up/down	Supported	---	Supported	Supported	Supported	Supported	Supported		
	Soft-start down function	Supported*	Supported*	Supported*	Supported*	Supported*	Supported*	Supported*	Supported	Supported
	Base-up function	Supported	---	---	---	Supported	Supported	---	Supported	Supported
	Load current limit	---	---	---	Supported	---	---	Supported	---	Supported
	Output upper/lower limits	---	---	---	---	---	---	---	Supported	Supported
Total run time exceeded detection	---	---	---	---	---	---	---	Supported	Supported	
I/O functions	Event inputs	1 (alarm reset)							2 (alarm reset) (automatic/manual selection or control method selection)	
	Alarm outputs	1	1	1	1	1	1	1	2 (warning, caution)	
	Serial communications (RS-485)	---	---	---	---	---	---	---	---	Supported

		G3PX						G3PW		
		Simple models	Advanced			Simple models	Advanced		Standard	Constant-current
Model		EUN	EH	EHN	EC	DU	DH	DC	EU	EC
Error monitoring	Overcurrent detection	---	---	---	Supported	---	---	Supported	---	Supported
	Single heater burnout detection	---	Supported	Supported	Supported	---	Supported	Supported	---	Supported
	Multiple heater burn-out detection	---	---	Supported (1 element out of 5)	---	---	---	---	---	Supported (1 element out of 10)
	SSR short-circuit (element ON failure detection)	---	Supported	Supported	Supported	---	---	---	Supported	Supported
	SSR open failure	---	---	---	---	---	---	---	Supported	Supported
	CT Failure	---	---	---	---	---	---	---	---	Supported
	Zero cross error	---	---	---	---	---	---	---	Supported	Supported
	External input range error (external input disconnection detection)	---	---	---	---	---	---	---	Supported	Supported
Power supply frequency error	---	---	---	---	---	---	---	Supported	Supported	

\* The soft-start down time is the same as the soft-start up time.

## 2-2 Nomenclature and Operations

### Nomenclature

A model with a terminal block with small slotted screws is shown as an example.

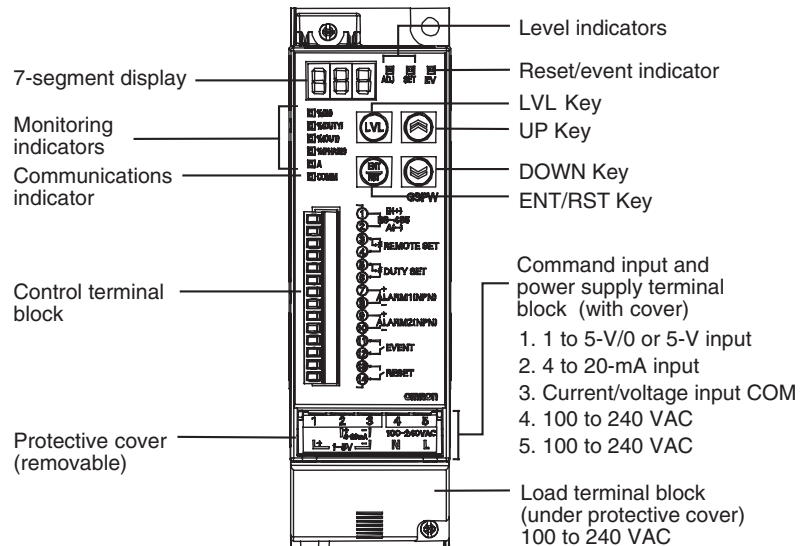

### Indicators

#### Level Indicators

Indicator	Description
■ ADJ	Lit when in the adjustment level.
■ SET	Lit when in the initial setting level.
■ EV	Lit when an external contact reset input or an event input is ON.

#### Monitoring Indicators

Indicator	Description
■ %(IN)	Lit when the input value is monitored in the monitor level.
■ %(DUTY)	Lit when the duty value is monitored in the monitor level.
■ %(OUT)	Lit when the output value is monitored in the monitor level.
■ %(PHASE)	Lit when the phase angle is monitored in the monitor level.
■ A	Lit when the current is monitored in the monitor level.

#### Communications Indicator





Indicator	Description
■ COMM	Lit when the serial communications are in progress.

#### 7-segment display

Kind of display	Description
Monitor level	Display the condition when working. The detail in Section 4-5 pages.
Parameter	Display the parameter item and value. The detail in Section 4-6 pages.
Error display	Display error number. The detail in Section 7-2 to 7-3 pages.



**Operation Keys**

Key symbol	Name	Description	Enabling condition
	LVL (Level) Key	Level Changes <ul style="list-style-type: none"> <li>• Monitor level ↔ Adjustment level</li> <li>• Monitor level ↔ Initial setting level</li> <li>• Software is reset when moving from the initial setting level to monitor level.</li> </ul>	Changing from monitor level to adjustment level or from monitor level to initial setting level is possible even when an error occurs.
	ENT/RST (Enter/Reset) Key	Set value display Set value change and entry Error reset	In the monitor level, the ENT/RST Key functions as a Reset Key only when an error occurs. (It does not function as a Reset Key when there is no error.)
	UP Key	Set value change Monitor item/set value number change	---
	DOWN Key		

**Command Input and Power Supply Terminal Block**

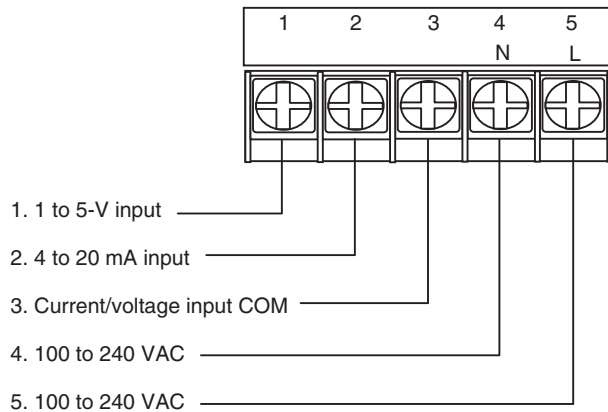

**Load Terminal Block (Under Protective Cover)**

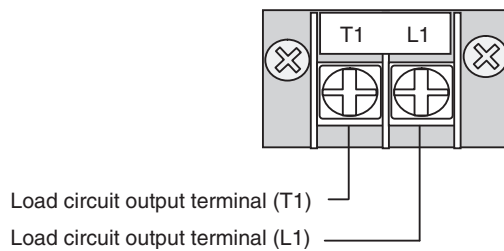

**Control Terminal Block**

■ **Screwless Clamp Terminal Block**

(FK-MCP1.5/14-ST-3.81; Phoenix Contact)

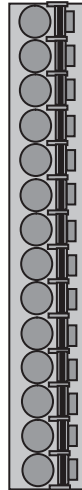

- 1. RS-485 (+)
- 2. RS-485 (-)
- 3. Main setting
- 4. Main setting COM
- 5. Duty setting
- 6. Duty setting COM
- 7. Alarm output 1 (+)
- 8. Alarm output 1 (-)
- 9. Alarm output 2 (+)
- 10. Alarm output 2 (-)
- 11. Event input (+)
- 12. Event input (-)
- 13. Reset input (+)
- 14. Reset input (-)

For standard models, 1 and 2 are not used.

■ **Terminal Block with Small Slotted Screws**

(MC1.5/14-ST-3.81; Phoenix Contact)

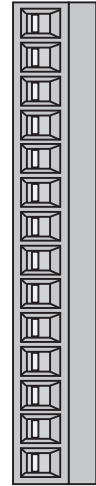

- 1. RS-485 (+)
- 2. RS-485 (-)
- 3. Main setting
- 4. Main setting COM
- 5. Duty setting
- 6. Duty setting COM
- 7. Alarm output 1 (+)
- 8. Alarm output 1 (-)
- 9. Alarm output 2 (+)
- 10. Alarm output 2 (-)
- 11. Event input (+)
- 12. Event input (-)
- 13. Reset input (+)
- 14. Reset input (-)

For standard models, 1 and 2 are not used.

Pin No.	Name	Description of function
1	RS-485 (+)	RS-485 communications
2	RS-485 (-)	
3	Main setting	Terminals for connecting external variable resistor for main setting
4	Main setting COM	
5	Duty setting	Terminals for connecting external variable resistor for duty setting
6	Duty setting COM	
7	Alarm output 1 (+)	Alarm output for fatal errors. The output to the load is stopped.
8	Alarm output 1 (-)	
9	Alarm output 2 (+)	Alarm output non-fatal errors. The output to the load is not stopped.
10	Alarm output 2 (-)	
11	Event input (+)	Terminals for connecting event inputs. The functions for event inputs are selected with parameter settings in the initial setting level using the Event Input Assignment parameter [P11].
12	Event input (-)	
13	Reset input (+)	The reset input is valid only for alarm level 2 (alarm output 2).
14	Reset input (-)	

# SECTION 3

## Installation and Wiring

The section describes how to install and wire the G3PW Power Controllers.

3-1	Installation Environment . . . . .	18
3-2	Installation . . . . .	21
3-3	Wiring . . . . .	26
3-3-1	Wiring the Power Supply and Load Circuits . . . . .	26
3-3-2	Command Input and Power Supply Terminal Wiring . . . . .	27
3-3-3	Wiring the Control Terminal Block . . . . .	29
3-3-4	Grounding . . . . .	32
3-3-5	Wiring an External Noise Filter . . . . .	32
3-4	Wiring for Specific Applications . . . . .	33

### 3-1 Installation Environment

#### Installation Environment

Use and store the Power Controller within the rated ambient temperature and humidity ranges. If more than one Power Controller is installed side-by-side or vertically, the heat that is generated will cause the internal temperatures of the Power Controllers to rise and will shorten their service life. In these kinds of installations, take suitable measures, such as installing fans for forced cooling.

The Power Controller is designed for indoor use only. Also, do not use the Power Controller in the following environments.

- Locations subject to water or oil
- Locations subject to direct sunlight
- Locations where dust or corrosive gases (in particular, sulfuric or ammonia gas) are present
- Locations where flammable or explosive gases are present
- Locations subject to extreme temperature changes
- Locations where icing or condensation may occur
- Locations subject to excessive shocks or vibration
- Locations subject to direct heat radiated from heating devices.

Take appropriate and sufficient countermeasures when installing systems in the following locations:

- Locations subject to static electricity or other forms of noise.
- Locations subject to strong electromagnetic fields.
- Locations subject to possible exposure to radioactivity.
- Locations close to power supplies.

#### Installation Location

When installing in a control panel, consider the ease of operation, ease of maintenance, and environmental factors.

**⚠ WARNING** Leave at least 100 mm of space above and below the Power Controller when installing it to allow heat to dissipate. Do not obstruct the area around the Power Controller and especially the area around the heat sink.

#### Ambient Temperature

The ambient operating temperature range is -15 to 55°C, but take the following considerations into account. When the ambient temperature exceeds 40°C, reduce the maximum load current as shown below.

#### ■ Current and Temperature Characteristics (G3PW-A220E/A245E)

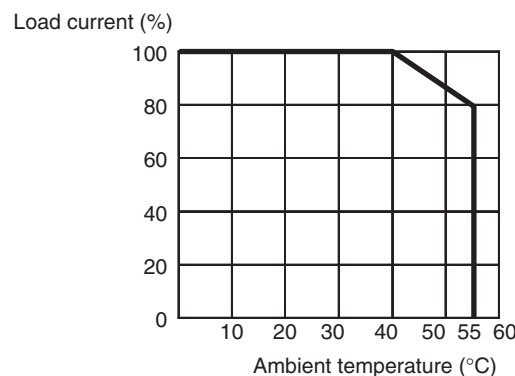

■ **Current-temperature Characteristic (G3PW-A260E)**

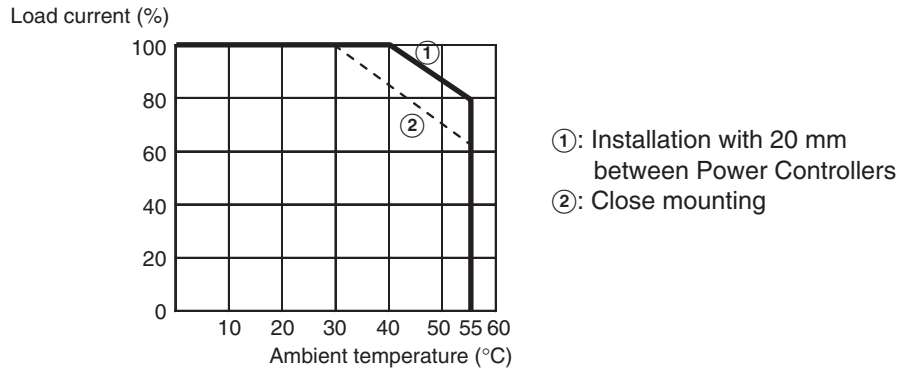

- At least 20 mm must be provided on the left and right sides of the G3PW-A260E. Refer to 3-2 Installation. If you must use side-by-side mounting, then reduce the maximum load current when the ambient temperature is over 30°C.
- Certification for safety standards was obtained with a mounting interval of 20 mm.
- Leave sufficient space for ventilation.
- Do not install the Power Controller above devices that generate significant amounts of heat, such as heaters, transformers, and high-capacity resistors.
- If the ambient temperature reaches 55°C or higher, install an air conditioner to lower the temperature.

**Note** If more than one Power Controller is installed side-by-side or vertically, the heat that is generated will cause the internal temperatures of the Power Controllers to rise and will shorten their service life. Take suitable measures, such as installing fans for forced-air cooling.

**Improving Noise Immunity**

- Do not install the Power Controller in a control panel together with high-voltage devices.
- Install the Power Controller at least 200 mm away from power lines.

■ **Recommended External Noise Filter**

We recommend installing a noise filter on the primary side to improve noise immunity.

Recommended filter: RSMN-series Filters from TDK-Lambda Corporation

RSMN-2030: For 20 A

RSMN-2060: For 45/60 A

Refer to 3-3-5 Wiring an External Noise Filter for wiring methods.

EMC Directives	EMI	EN 60947-1
		EN 60947-4-3
	EMS	EN EN60947-1
		EN EN60947-4-3

### Resistance to Inrush Current

The solid lines in the following graphs show the non-repetitive resistance to inrush current. For repetitive inrush current, keep the inrush current below the values shown by the dotted lines.

■ G3PW-A220E□

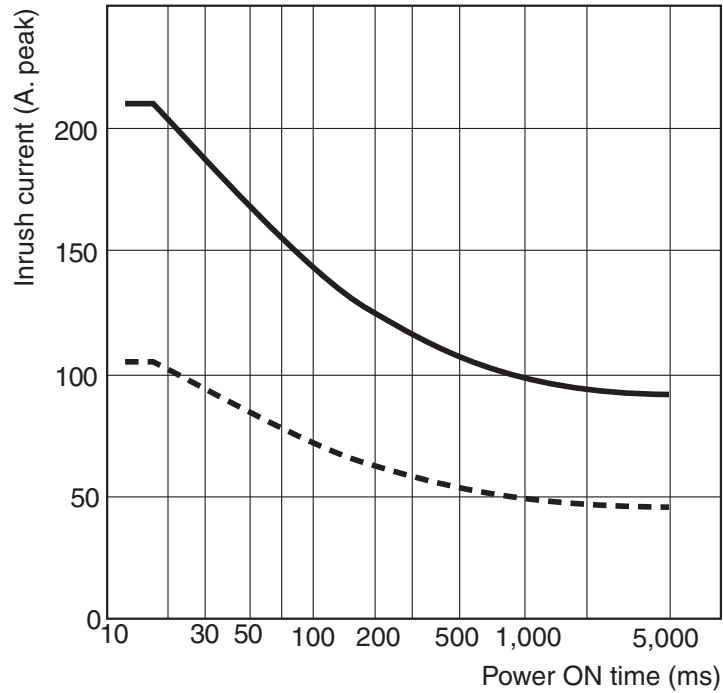

■ G3PW-A245E□/A260E□

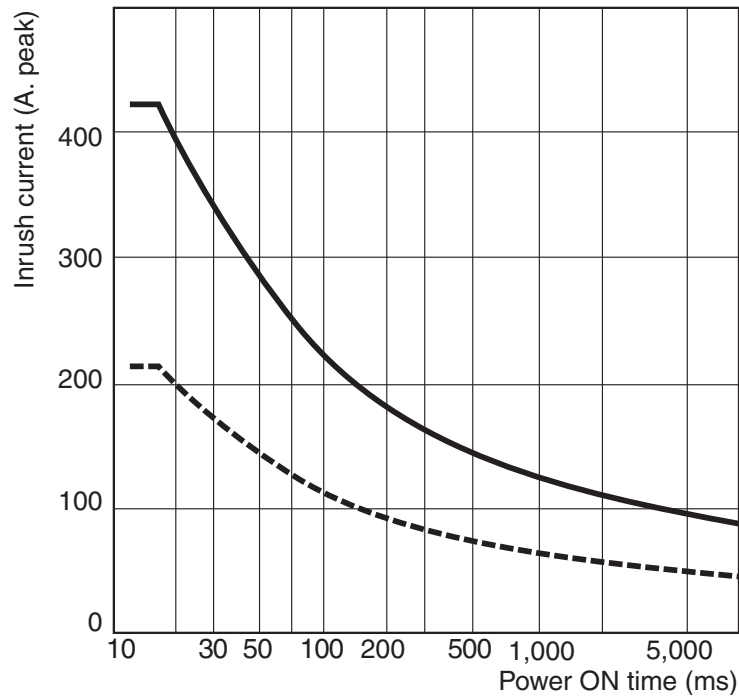

### 3-2 Installation

#### Installation Direction

For cooling efficiency, install the Power Controller in the correct direction. The Power Controller generates a lot of heat, and it uses natural heat convection for cooling. Installing the Power Controller in the wrong direction may cause it to malfunction or to be damaged.

**⚠ WARNING** Install the Power Controller in the direction shown in this manual. The Power Controller generates a lot of heat and it uses natural heat convection for cooling. Installing the Power Controller in the wrong direction may cause in malfunctions or accidents.

**⚠ WARNING** Leave at least 100 mm of space above and below the Power Controller when installing it to allow heat to dissipate. Do not obstruct the area around the Power Controller and especially the area around the heat sink.

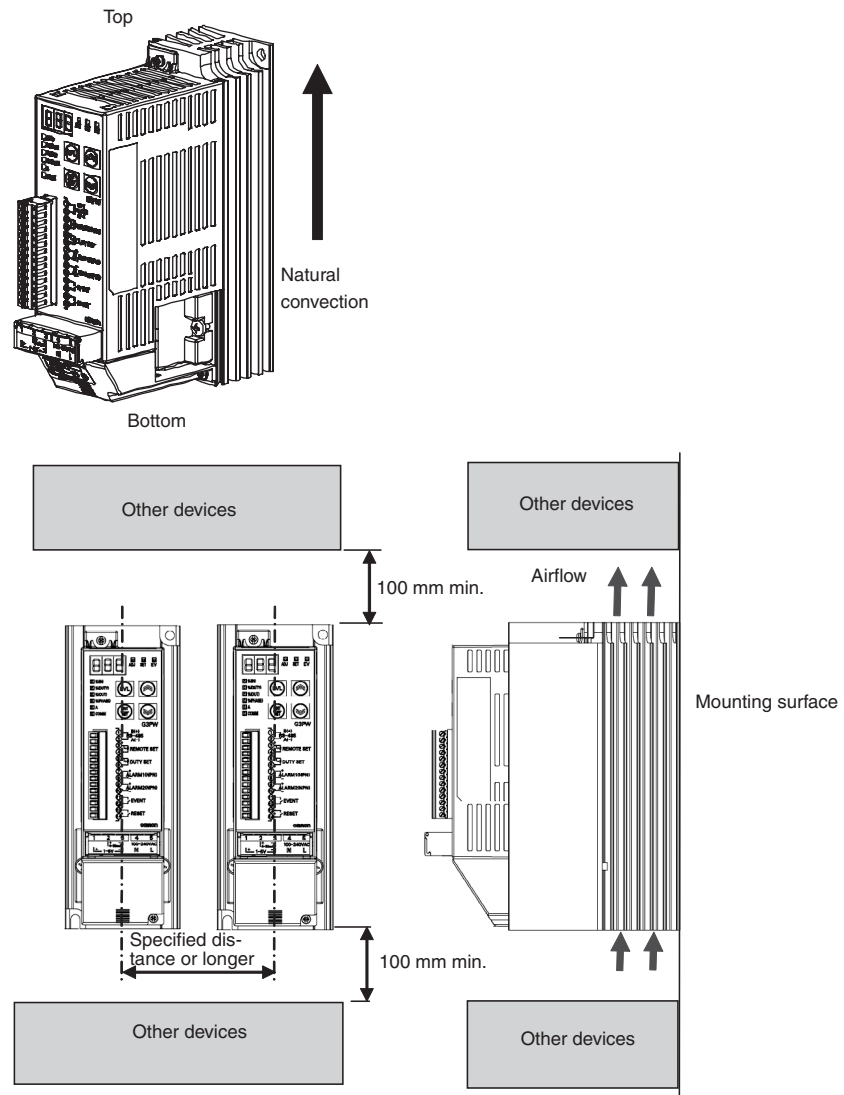

**External Dimensions and Mounting Hole Dimensions**

**G3PW-A220E□-S (20-A Models with Terminal Block with Small Slotted Screws)**

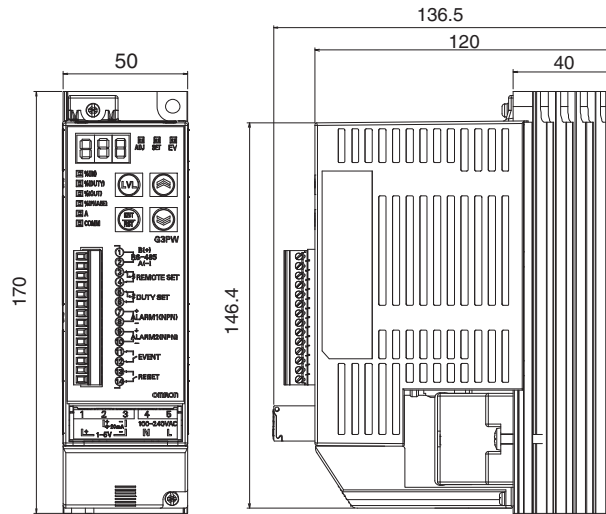

**G3PW-A220E□-C (20-A Models with Screwless Clamp Terminal Block)**

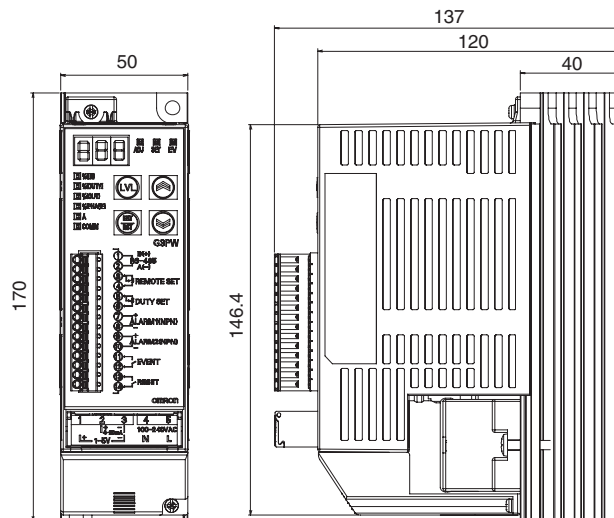

**G3PW-A245E□-S/A260E□-S (45/60-A Models with Terminal Block with Small Slotted Screws)**

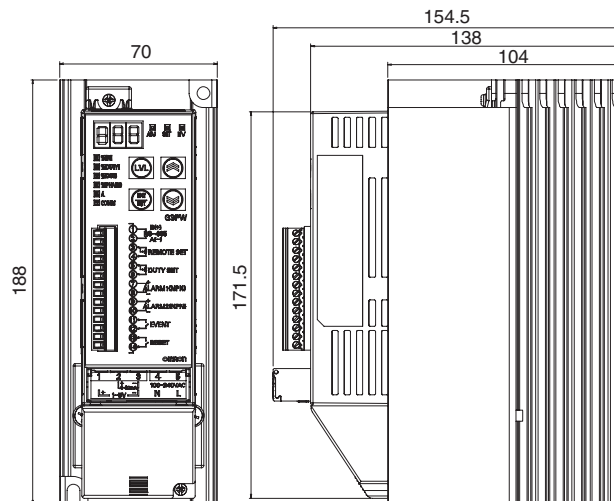





■ G3PW-A260

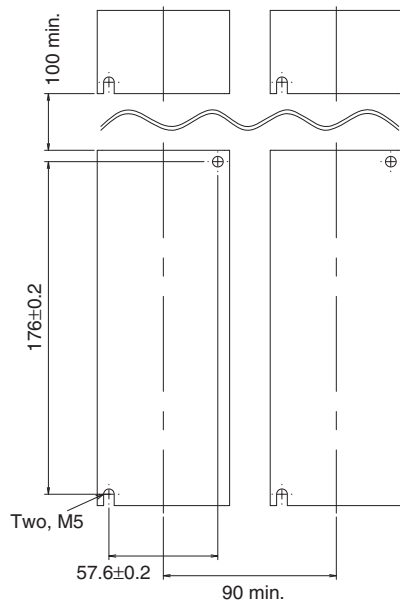

**Mounting Screws**

Model	Tightening torque	Screw size
All models	2.3 to 2.5 N·m	M5, length: 10 mm min.

**Control Panel Ventilation**

The G3PW Power Controller generates a lot of heat and it uses natural heat convection for cooling. Mounting the Power Controller in the wrong direction may obstruct heat radiation and cause malfunctions or accidents. To increase cooling efficiency, mount the Power Controller in the correct direction and take control panel ventilation and the installation location into consideration to avoid obstructing heat dissipation.

**Mounting Position in Relation to Wiring Duct**

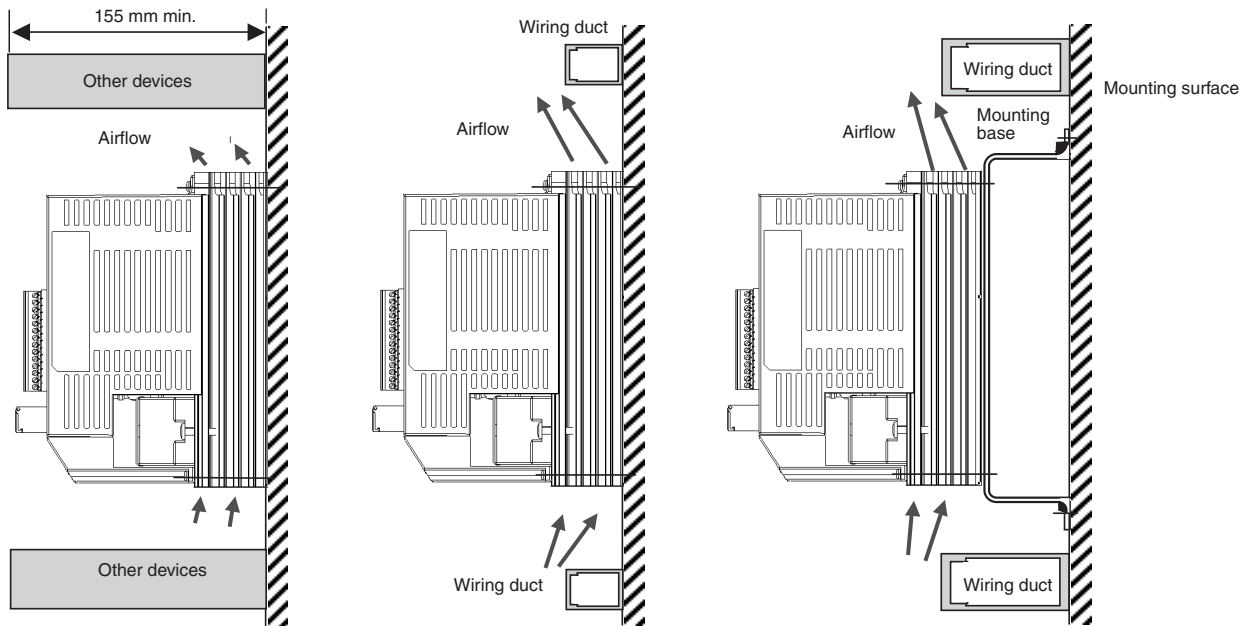

If a device with a depth of 155 mm or more blocks the top or bottom of the Power Controller, the flow of air will be obstructed and heat will not dissipate.

Use short wiring ducts or other devices around the Power Controller

If tall devices or wiring ducts must be used, take measures such as mounting the Power Controller to a mounting base to improve ventilation.

**Control Panel Ventilation**

When mounting the Power Controller in a control panel, consider measures such as installing louvers or fans for ventilation in the control panel.

- If the air intake and outlet ports have filters, perform periodic maintenance to prevent the filters from becoming clogged.
- Install devices in such a way that airflow is not blocked inside or outside of the air intake and outlet ports.
- If using a heat exchanger for cooling inside the panel, it is most effective to mount it on the front of the Power Controller.

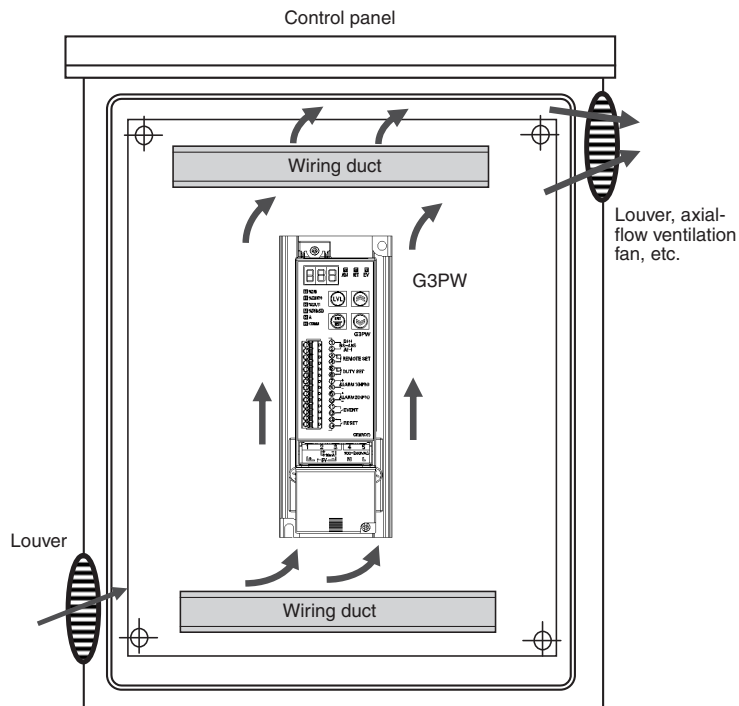

## 3-3 Wiring

### 3-3-1 Wiring the Power Supply and Load Circuits

- First, connect the load to load terminal T1 and to the power supply, and then connect the power supply to load terminal L1 through a fast-acting fuse.
- Connect the AC power supply to power supply terminals 4 (N) and 5 (L).
- The AC power supply ground polarity and the G3PW terminal block polarity are not related, but connect the 4 (N) and 5 (L) terminals on the command input/power supply terminal block and the T1 and L1 terminals of the load terminal block to power supplies with the same phases.
- Always connect the load to load terminal T1.

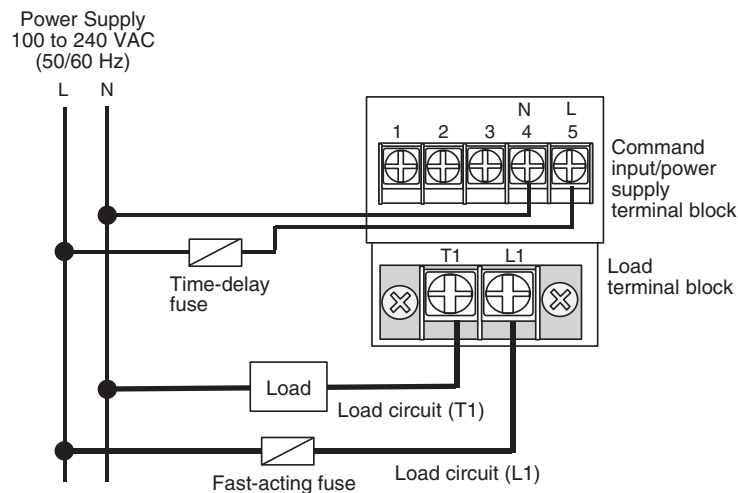

**⚠ WARNING** Make sure that the phases match for load terminal T1 and power supply terminal 4 (N), and for load terminal L1 and power supply terminal 5 (L). If the connections are incorrect, the Power Controller will not operate normally or the load may be damaged.

After wiring the power supply terminal block or load terminal block, do not touch the terminals again with a load applied. Risk of electric shock because the power supply terminal block and load terminal block are not isolated for the purpose of a warning function. (Between terminals 4, 5 on the power supply terminal block and load terminals T1, L1.)

**⚠ Caution** When connecting from line connected to load terminal T1 to power supply terminal 4 (N), connect it from a point that is as close as possible to the power supply. If the connection is incorrect, the Power Controller failure detection functions will generate an E10 error and stop output operation. And check the connection again.

**⚠ Caution** When using the Power Controller to control the power to the primary side of a transformer, do not open the circuit on the secondary side of the transformer during Power Controller operation.

**⚠ Caution** In regard to Ver 1.1, it's possible to reset E10 error condition of G3PW used to ENT/RST key, reset input terminal, or communication command (only FLK type).

### Wiring the Load Terminal Block

#### Recommended Wires

When connecting to the load terminals, use the specified wire size for each model of Power Controller.

Model	Recommended wire size	Tightening torque	Terminal screws
G3PW-A220	AWG 10 to 18	1.8 N·m	M4
G3PW-A245	AWG 6 (See note.)	2.8 N·m	M5
G3PW-A260			

**Note** Crimp terminals that conform to UL and CSA specifications must be used.

**Caution** Be sure to keep terminal screws tightened to the torque specified below. Loose screws may occasionally cause a fire.

#### Recommended Crimp Terminals

- Either use insulated crimp terminals or cover the crimp terminals with insulating sleeves.
- Always use the following crimp terminals to wire the load terminals.
- Do not connect more than two crimp terminals to one terminal screw.



Model	A
G3PW-A220	9.5 mm max.
G3PW-A245/A260	12 mm max.

#### Recommended Fuses

	Super-rapid Fuse (Fuji Electric)		Fuse Holder (Fuji Electric)
Fast-acting fuse *	For 20 A	CR6L-20/UL	CMS-4
	For 45 A	CR6L-50/UL	
	For 60 A	CR6L-75/UL	CMS-5
Time-delay fuses	250 VAC, 2 A		

\* For UL certified products, please inquire separately.

## 3-3-2 Command Input and Power Supply Terminal Wiring

### Command Input and Power Supply Terminal Wiring

#### Voltage Input (1 to 5 VDC)

When using a voltage input, connect the positive and negative signal wires to terminals 1 and 3, respectively.

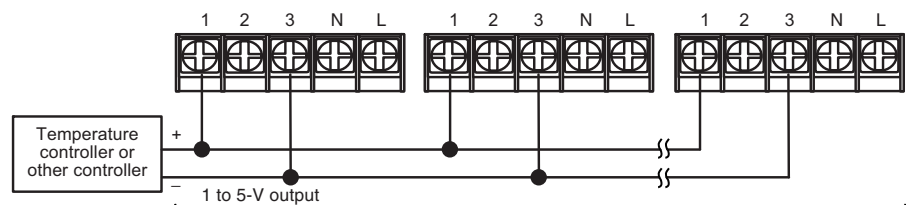

ex) It is possible to connect 6 pcs max when impedance is 5 kΩ min.

**Current Input (4 to 20 mA DC)**

When using current input, connect the positive and negative signal wires to terminals 2 and 3, respectively.

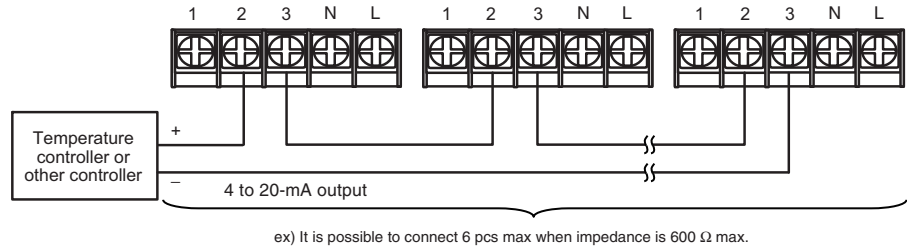

**Note** When connecting multiple units using current input, do not use the negative terminals (12/14) connected to the G3PW event input / reset input, and power supply input terminal \_3, as a negative common. G3PW units after the first unit may not operate.

**ON/OFF Voltage Input (0 or 5 VDC or 5 VDC)**

When using an ON/OFF voltage input, connect the positive and negative signal wires to terminals 1 and 3, respectively.

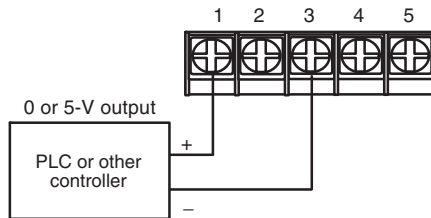

The G3PW may be damaged if a command voltage that is higher than 5 V is applied. If it is necessary to apply more than 5 V, split the voltage as shown below by inserting resistance in the line to terminal 1 and applying the voltage across terminals 1 and 3. The internal impedance between terminals 1 and 3 is 30.1 kΩ.

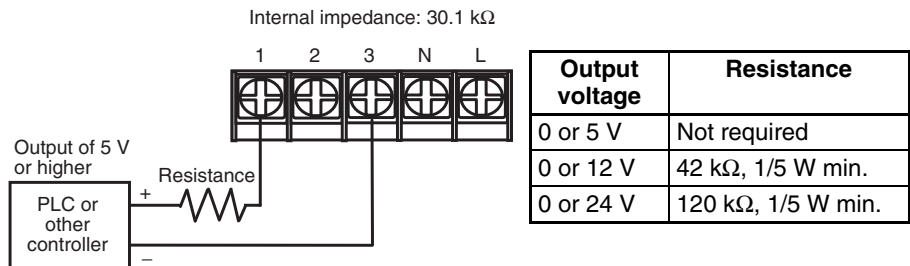

**Command Input and Power Supply Wire Sizes**

Model	Recommended wire diameter	Tightening torque	Terminal screws
All models	AWG 14 to 18	0.8 to 1.0 N·m	M3.5

**Recommended Crimp Terminals**

Always use the following crimp terminals (for M3.5) to wire to the command input and power supply terminals.

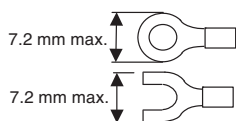

### 3-3-3 Wiring the Control Terminal Block

#### Recommended Wire Sizes and Connection Method

- G3PW-A2□□E□-S (Models with terminal blocks with small slotted screws)
- G3PW-A2□□E□-C (Models with screwless clamp terminal block)
- Wire Sizes for Control Terminals (Models with Small Slotted or Screwless Clamp Terminals)

Model	Recommended wire diameter	Tightening torque (See note.)	Terminal screws (See note.)
All models	AWG26 to AWG16	0.22 N·m	M2

**Note** Only models with terminal blocks (Only G3PW-A2□□E□-S type) with small slotted screws have terminal screws.

- Use copper AWG26 to AWG16 twisted-pair cable when connecting the wires directly.
- Strip the wire sheathing for the following lengths, according to the connector type.
  - Small slotted terminals: 7 mm
  - Screwless clamp terminals: 9 mm
- When using twisted wires, it is recommended that you attach a ferrule with an insulating cover that conforms to DIN 46228-4 and connect the ferrule to the terminal.
- Use shielded twisted-pair wires for RS-485 communications wires. A maximum of 500 m total of wiring can be used.

#### Terminal Names

A screwless clamp terminal block is shown as an example.

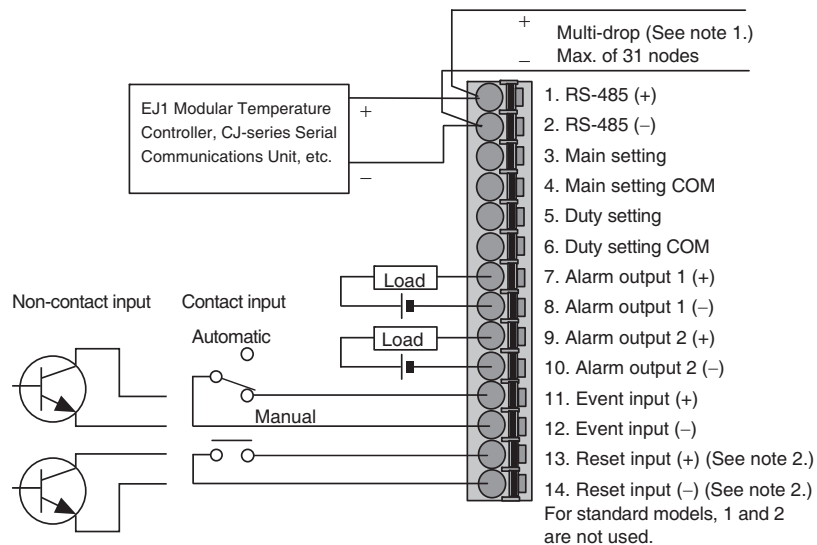

- Note**
- (1) A terminator must be connected at each end of the RS-485 transmission path. Set a combined resistance of at least 54 Ω according to the PLC or other host and connect the terminators.
  - (2) Do not series or parallel connecting for common reset input.

Wiring Inputs for External Settings

■ Wiring to Adjust the Main Setting

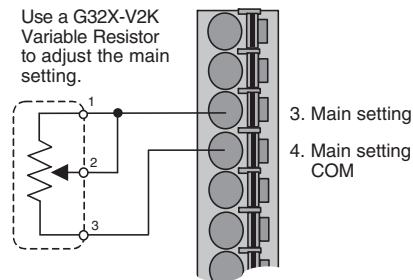

■ Wiring to Adjust the Duty Setting

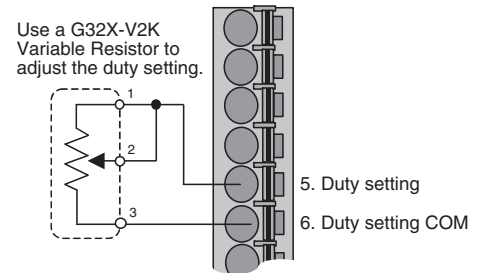

Alarm Outputs

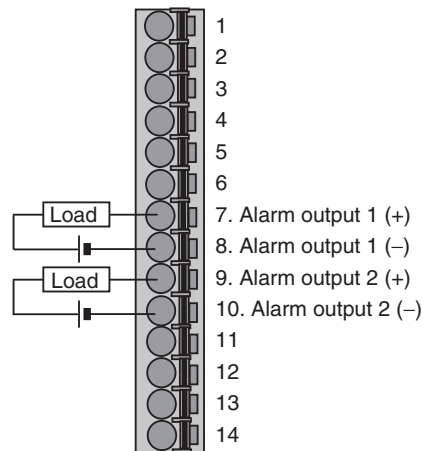

<b>Output status</b>	Open collector
<b>Number of outputs</b>	2
<b>Maximum operating voltage</b>	30 VDC
<b>Maximum load current</b>	50 mA
<b>Maximum residual voltage</b>	1.5 V
<b>Maximum leakage current</b>	0.4 mA

1,2,3...

1. When alarm output 1 or alarm output 2 is reset (i.e., the power turns ON or the initial setting level is exited), the alarm output will be inactive for 1 second. Allow for this in the system design when using an alarm output.

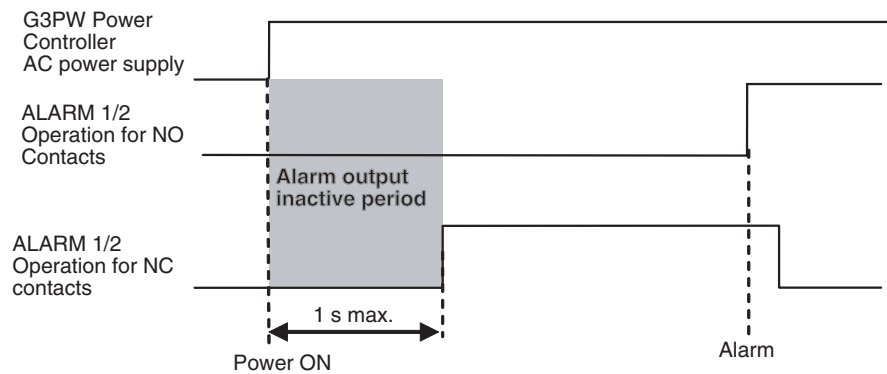



- If you connect a contact relay or any device containing a coil to the alarm output, wire a diode in parallel with the relay coil, as shown in the figure.

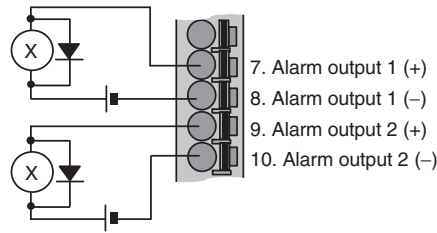

■ Operation Selection Input

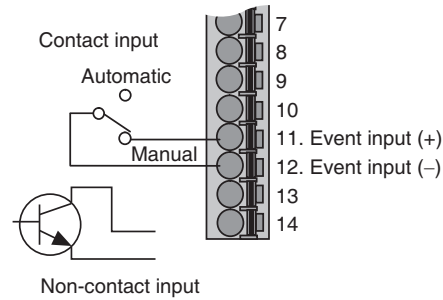

■ Reset Input

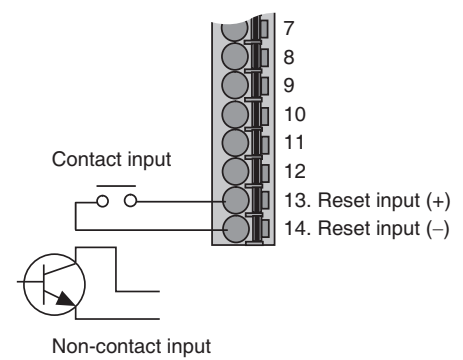

**Note** Do not series or parallel connecting for common reset input.

<b>Number of event inputs</b>	2 event inputs
<b>Contact input conditions</b>	ON: 1 kΩ max. OFF: 100 kΩ min.
<b>Non-contact input conditions</b>	ON residual voltage: 1.0 V max. OFF leakage current: 0.1 mA max.
<b>Current flow</b>	Approx. 1.1 mA (per input)

■ Communications Terminals

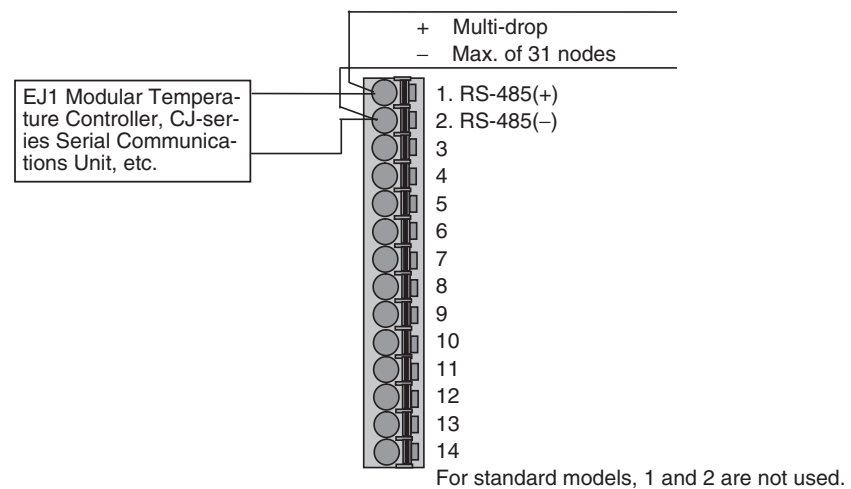

- The terminating resistance is 54 Ω min. combined.
- Both ends of the transmission path (including the host computer if it is at one end), must be specified as end nodes (terminating resistance). Use a combined terminating resistance of at least 54 Ω.
- The EJ1 has an internal terminating resistance of 120 Ω. Install terminating resistance (110 to 125 Ω, 1/2 W) at only the end G3PW Power Controller.
- COMLED indicator flash when nothing connect to terminal number 1 and 2. Install terminating resistance (120 Ω, 1/2 W).

### 3-3-4 Grounding

Always ground the Power Controller to 100 Ω or less. There are no ground terminals provided, so use the heat sink mounting screws as ground terminals.

### 3-3-5 Wiring an External Noise Filter

Always insert a noise filter in the power supply lines to the G3PW.

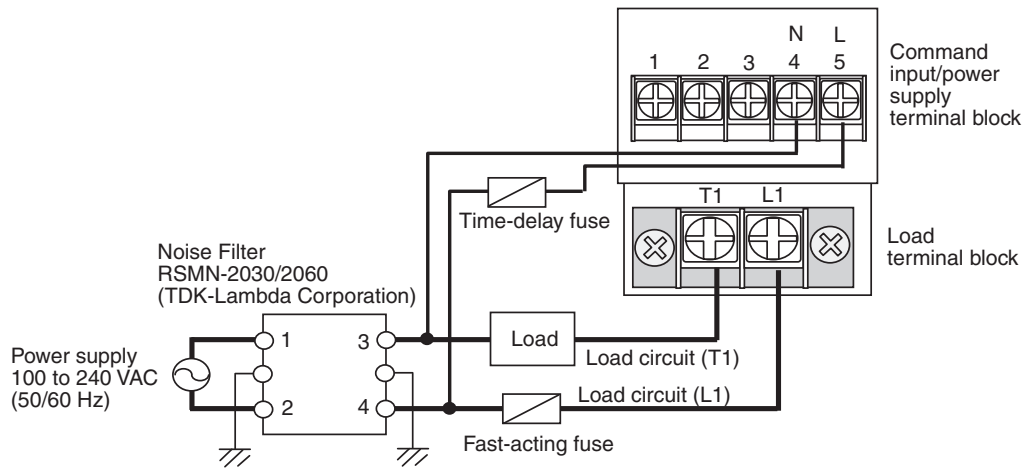

### 3-4 Wiring for Specific Applications

#### Automatic Operation

##### Wiring Example for Automatic Operation Using Current Signal Input of 4 to 20 mA

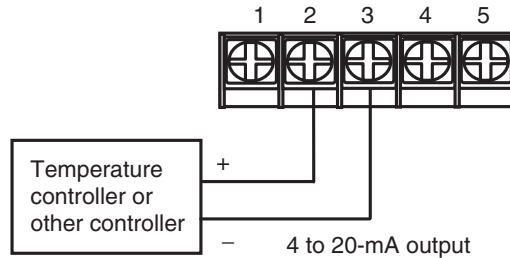

##### Wiring Example for Automatic Operation Using Voltage Signal Input of 1 to 5 V

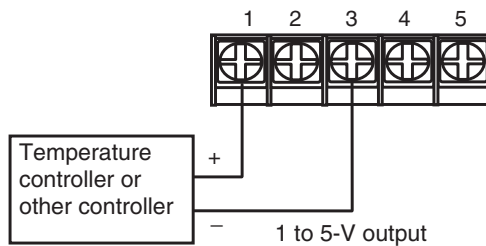

##### Wiring Example for Automatic Operation Based on RS-485 Communications

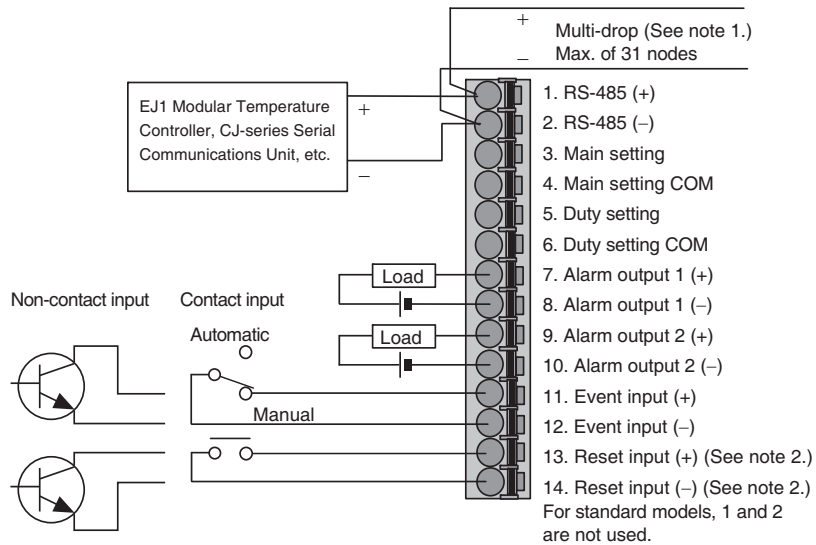

- Note**
- (1) A terminator must be connected at each end of the RS-485 transmission path. Set a combined resistance of at least 54 Ω according to the PLC or other host and connect the terminators.
  - (2) Do not series or parallel connecting for common reset input.

**Manual Operation**

**Wiring Example for Using an External Variable Resistor for the Main Setting**

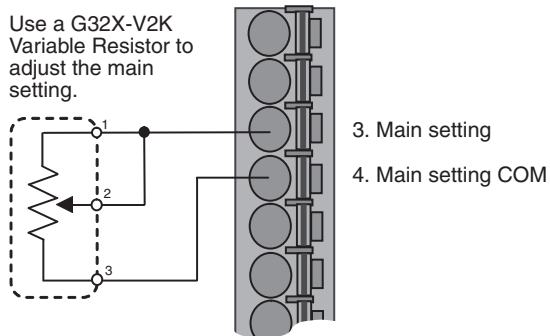

**Wiring Example for Using an External Variable Resistor for the Duty Setting**

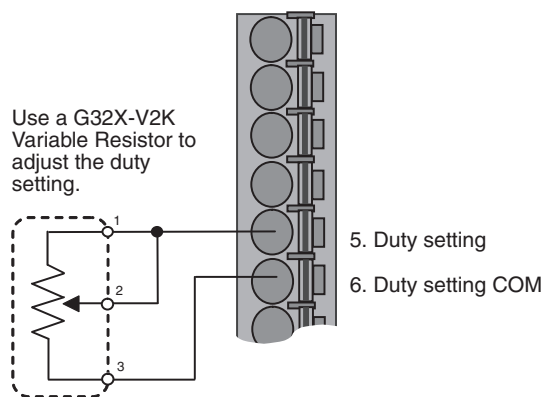

# SECTION 4

## Control Methods and I/O Configuration

This section describes the control methods that you can use, the I/O configuration, and how to set parameters for the G3PW Power Controllers.

4-1	Control Methods . . . . .	36
4-2	Output Modes . . . . .	37
4-3	Monitored Items . . . . .	38
4-4	Input System . . . . .	39
4-5	Procedures for Operation and Setting Parameters . . . . .	41
4-6	Setting Parameters in the Initial Setting Level . . . . .	44

## 4-1 Control Methods

Any of the following methods can be used as the output mode for the G3PW Power Controller: Phase control, optimum cycle control, or ON/OFF control. In addition, it is possible to switch between phase control and optimum cycle control during operation.

### Phase Control

With phase control, the phase-angle range for the AC voltage supplied to the load is changed by the switching element to continually change the power supplied to the load.

Phase control is suitable for precise temperature control or for controlling heaters with large inrush currents.

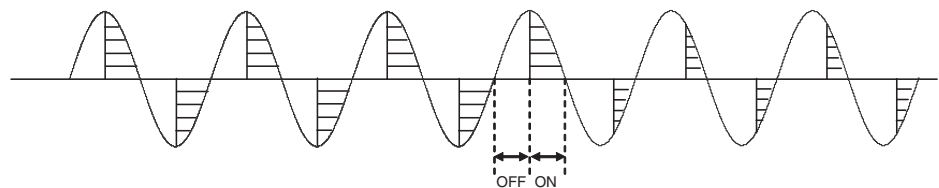

### Optimum Cycle Control

With optimum cycle control, the output is turned ON and OFF with each AC half cycle. The output is switched at the voltage zero-cross point, enabling high-precision temperature control while suppressing noise.

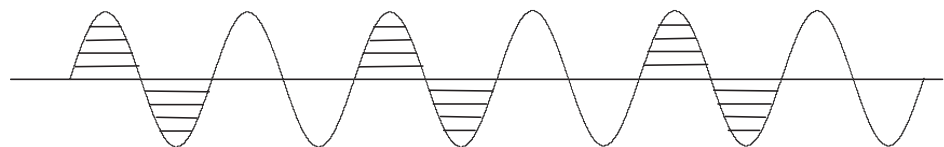

### ON/OFF Control

With ON/OFF control, the control output is switched ON and OFF based on the ON/OFF voltage signal from the temperature controller. The output phase angle is set using operation keys or an external variable resistor.

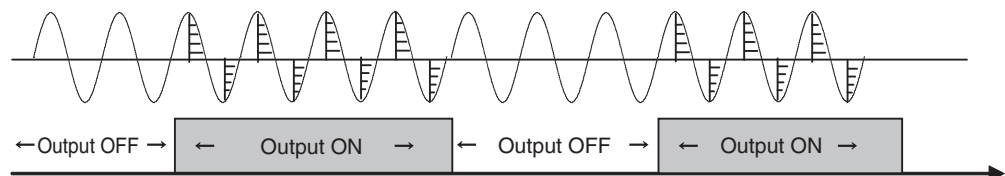

## 4-2 Output Modes

When phase control is used as the control method, any of the following four modes can be selected for the relationship of the control value to the output value.

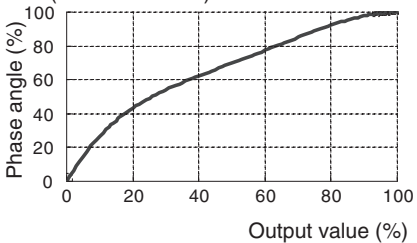
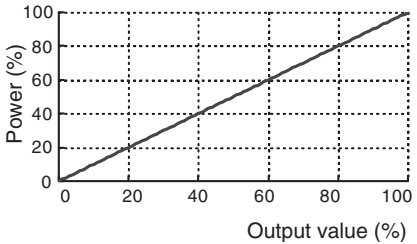
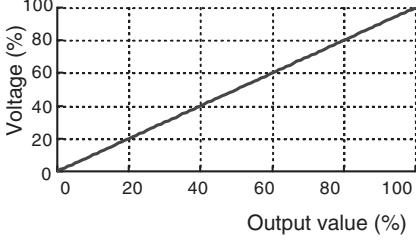
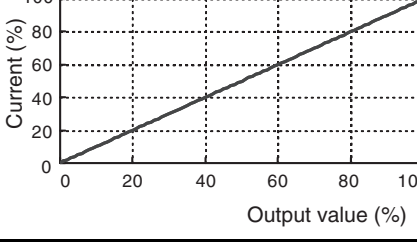
<p>Control proportional to phase angle (same as G3PX)</p>	<p>In this mode, the relationship of the output phase angle to the output value has the same characteristics as for the G3PX Power Controller.</p>	<p>Control Proportional to Phase Angle (Same as G3PX)</p> 
<p>Control proportional to square voltage</p>	<p>In this mode, the square of the output voltage is proportional to the output value. When the load resistance is constant, the output power value is proportional to the output value.</p>	<p>Control Proportional to Square Voltage</p> 
<p>Control proportional to voltage</p>	<p>In this mode, the output voltage is proportional to the output value.</p>	<p>Control Proportional to Voltage</p> 
<p>Constant-current control (Constant-current Models only)</p>	<p>In this mode, the load current is proportional to the output value. The duty setting changes with the load resistance. To suppress the output current, use the duty setting function to suppress the duty.</p>	<p>Constant-current Control</p> 

### 4-3 Monitored Items

Values for the following five items can be monitored on the 7-segment display during operation in monitor level.

However, when G3PW restart, "Input Value (%)" is indicated at first.

■ **Input Value (%)**

The main setting that was set by automatic or manual input is displayed.

■ **Duty Value (%)**

The duty calculated from the internal and external duty settings is displayed.

$$\text{Duty value (\%)} = \text{Internal duty setting (\%)} \times \text{External duty setting (\%)}$$

■ **Output Value (%)**

The output value in relation to the input value is displayed after applying the base-up value, output limits, soft-start up/down settings, and load current limit. If no processing is performed, the output value will be the same as the input value.

■ **Output Phase Angle (%)**

The thyristor module output phase angle (%) calculated from the output value is displayed according to the output mode. When the proportional to phase angle mode is used as the output mode, the output value and the output phase angle will be the same.

■ **Load Current (A)**

The load current (A) detected by the built-in CT is displayed. This feature is supported for Constant-current Models only.

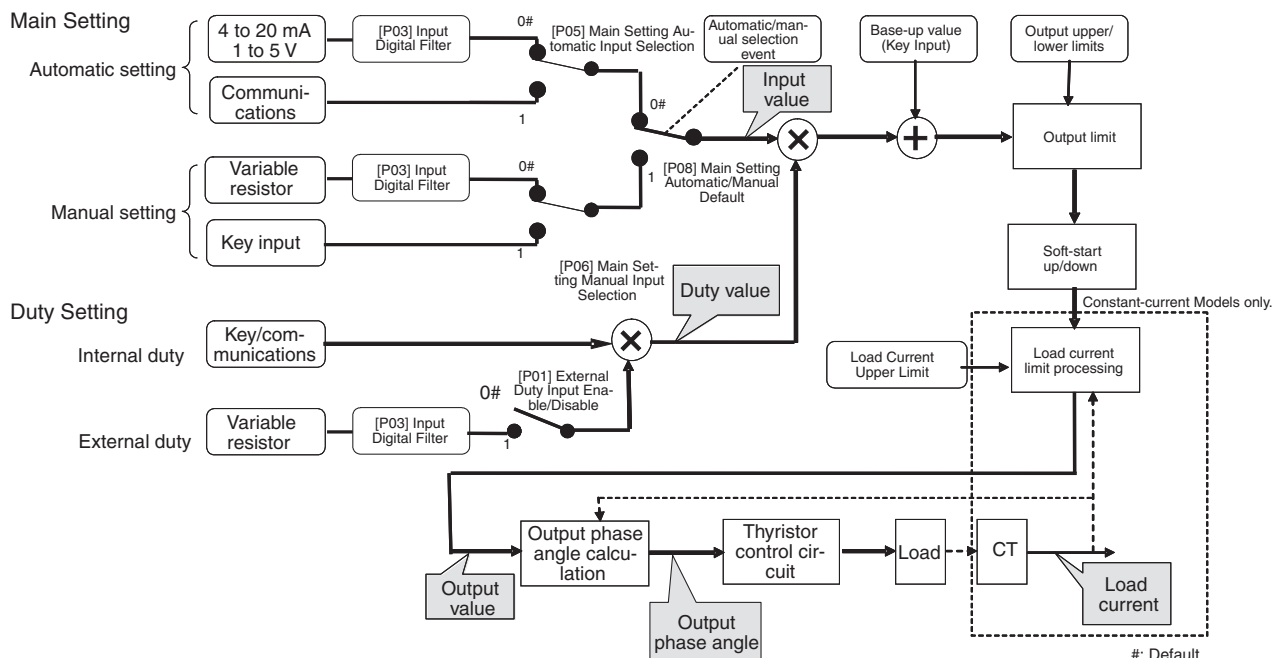

Figure 1 Signal Flow Diagram (for Other than ON/OFF Control)



## 4-4 Input System

### Main Setting Input

The main setting can be selected from the following five input systems.

### Automatic Input

#### ■ Analog input (4 to 20 mA or 1 to 5 V)

Used to connect to outputs such as the linear output from a Temperature Controller.

#### ■ Communications (RS-485)

Used to connect with a device that uses the CompoWay/F protocol such as for the EJ1 Modular Temperature Controller.

#### ■ Voltage ON/OFF input (0 or 5 VDC)

Used to connect to outputs such as a time-proportional control output from a temperature controller. (Only for commands for switching outputs ON and OFF with 5 V or 0 V. The input value is set manually.)

### Manual Input

#### ■ External Variable Resistor Main Setting

Use an external G32X-V2K Variable Resistor to set the input value.

#### ■ Key Input Main Setting

Use the keys on the front of the G3PW Power Controller to directly set the input value.

However, in case G3PW restart, input value become zero. It is necessary to re-enter.

\* In case main parameter is written used to communication command, input value become zero after G3PW restart.

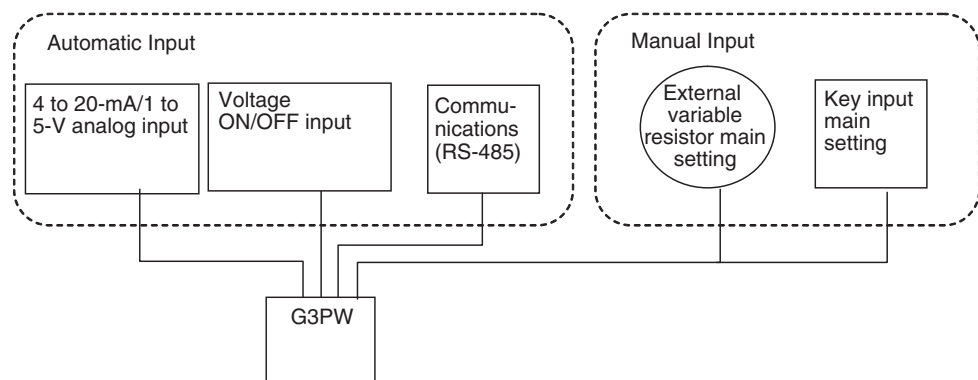

**Relationship between Input Signal and Input Value**

There is a linear relationship (i.e., a proportional relationship) between an analog input signal and the input value.

Manual input: There is a non-linear relationship between the external variable resistor main setting and the input value.

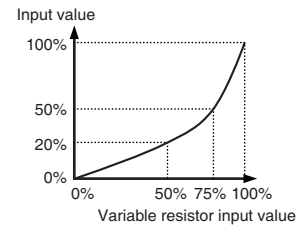
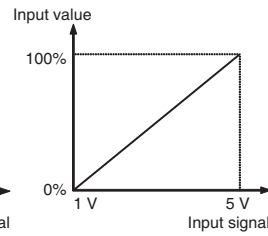
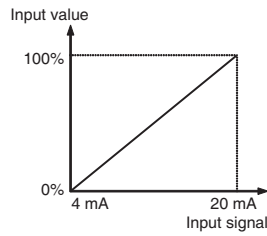

## 4-5 Procedures for Operation and Setting Parameters

### Operating Procedure

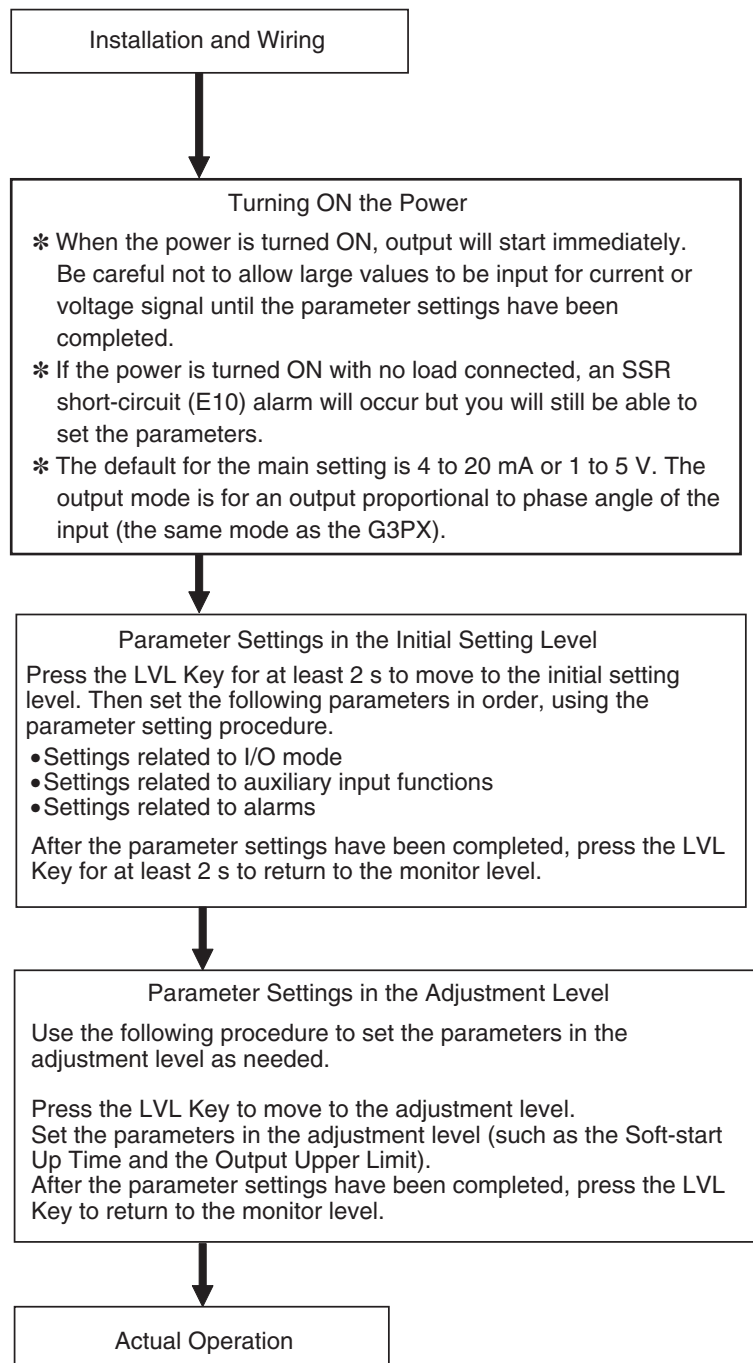

Parameter Settings

Operation Level

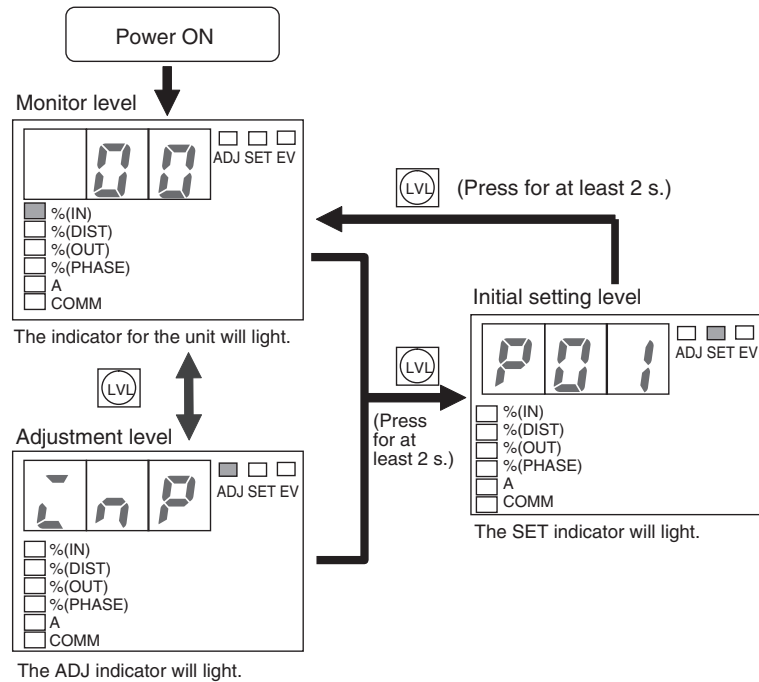

- The level when power is turned ON is the monitor level. Normal operation is performed in the monitor level.
- Press the LVL Key to move to the adjustment level. In the adjustment level, parameter settings can be changed during operation. Press the LVL Key again to return to the monitor level.
- While in the monitor level or the adjustment level, press the LVL Key for at least 2 s to move to the initial setting level. Then make the parameter settings in the initial setting level. In this level, power to the load is turned OFF.
- Press the LVL Key for at least 2 s to return to the monitor level from the initial setting level. It is not possible to directly return to the adjustment level from the initial setting level.

Setting Parameters in the Initial Setting Level

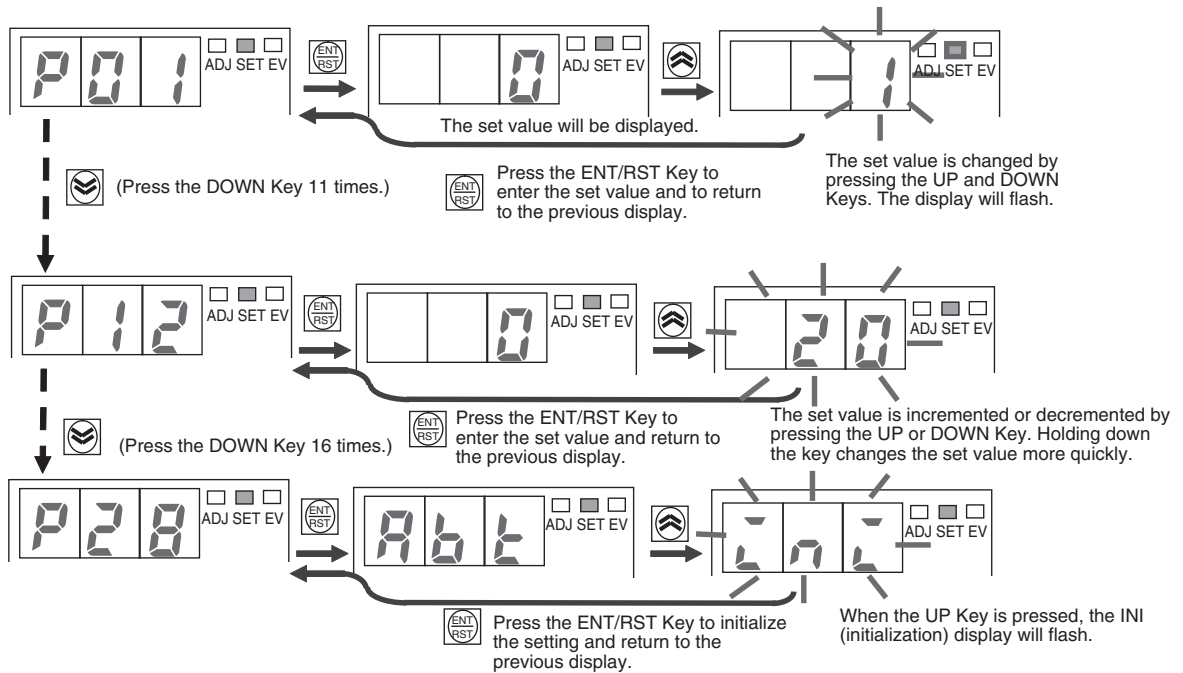

- 1,2,3...
1. Press the UP and DOWN Keys to select the parameter that is to be set from External Duty Input Enable/Disable parameter [P01] to Initialize Set Values parameter [P30] or [P31]\*.
  2. Press the ENT/RST Key to display the parameter set values.
  3. Use the UP and DOWN Keys to change a set value. When the UP or DOWN Key is pressed, the display will start flashing.
  4. Press the ENT/RST Key to enter the setting and return to the previous parameter (External Duty Input Enable/Disable parameter [P01] to Initialize Set Values parameter [P30] or [P31]\*).
  5. After Ver1.1, [P29] [P30] [P31] are added.
- \* [P31] for only FLK type.

# 4-6 Setting Parameters in the Initial Setting Level

## Settings Related to I/O Parameters

### Determining the Output Mode

#### Setting the Main Setting

#### Typical Output Mode

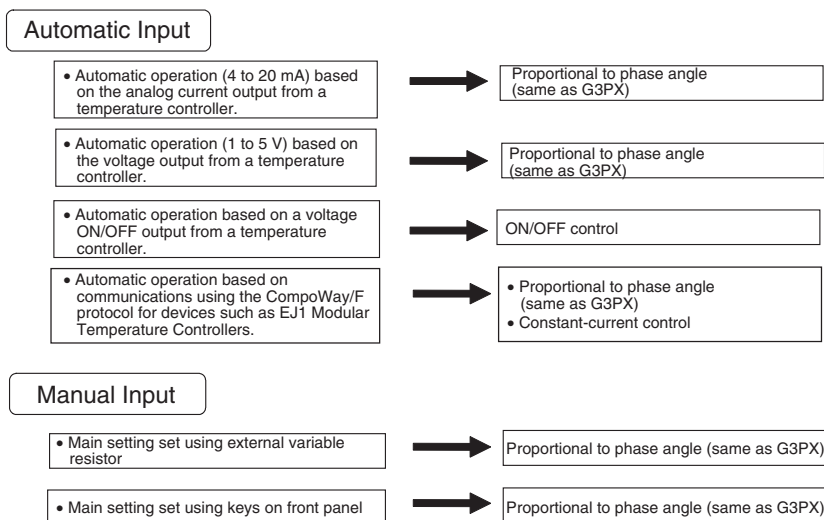

### Parameter Setting Procedure

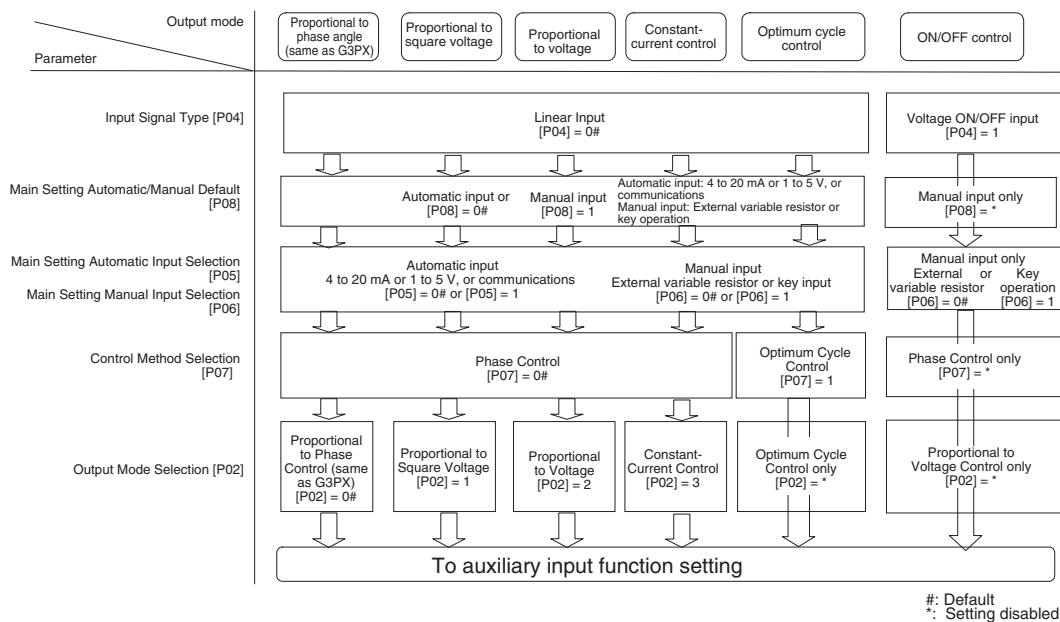

**Parameter Settings Related to Auxiliary Inputs**

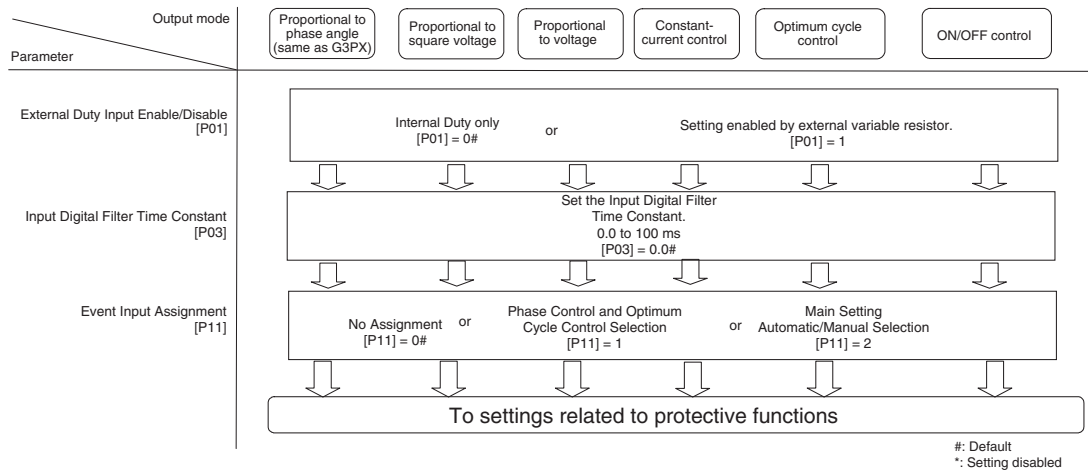

**Main Setting Input Parameter Settings**

The following table shows the relationship between the parameters related to inputting the main settings.

			Main Setting Automatic Input Selection [P05]	Main Setting Manual Input Selection [P06]	
<b>Event Input Assignment [P11]</b>	0 (No assignment) or 1 (Control method selection)	Main Setting Automatic/Manual Default [P08]	0 (Automatic) Main setting input using linear input or communications.	0 (4 to 20 mA or 1 to 5 V) 1 (Communications)	---
			1 (Manual) Main setting input using an external variable resistor or using key operation.	---	0 (External variable resistor) 1 (Key input)
	2 (Main setting automatic/manual selection)	Event input Open (Automatic)		0 (4 to 20 mA or 1 to 5 V) 1 (Communications)	---
			Event input Closed (Manual)	---	0 (External variable resistor) 1 (Key input)

**Parameter Settings Related to Protective Functions**

**Alarm Level**

The G3PW Power Controller has two alarm contact outputs: Alarm output 1 (ALARM1) and alarm output 2 (ALARM2). For the following alarms, the contacts to which to output an alarm when an error occurs can be selected with a parameter setting in the initial setting level.

Alarm level	Parameter setting level	Operation
No alarm	0	No error is detected.
Alarm level 1	1	The alarm is output to alarm output 1. The output to the load is stopped when a fatal error is detected, and the error is displayed on the 7-segment display.
Alarm level 2	2	The alarm is output to alarm output 2. The error is displayed on the 7-segment display and operation continues.

**Note** Errors will not be detected if no alarm output is assigned.

**Alarms for which Alarm Output Contacts Can Be Assigned**

- Heater burnout alarm (E40)
- External input range alarm (external variable resistor disconnection detection) (E50)
- External duty input alarm (external variable resistor disconnection detection) (E51)
- Total run time exceeded alarm (E60)

- Note**
- (1) If multiple errors occur, the most recent error will be displayed on the 7-segment display. (For details on error numbers, refer to 7-2 Error Displays.)
  - (2) Errors other than the above are set to alarm level 1 and cannot be changed.

**Setting Procedure**

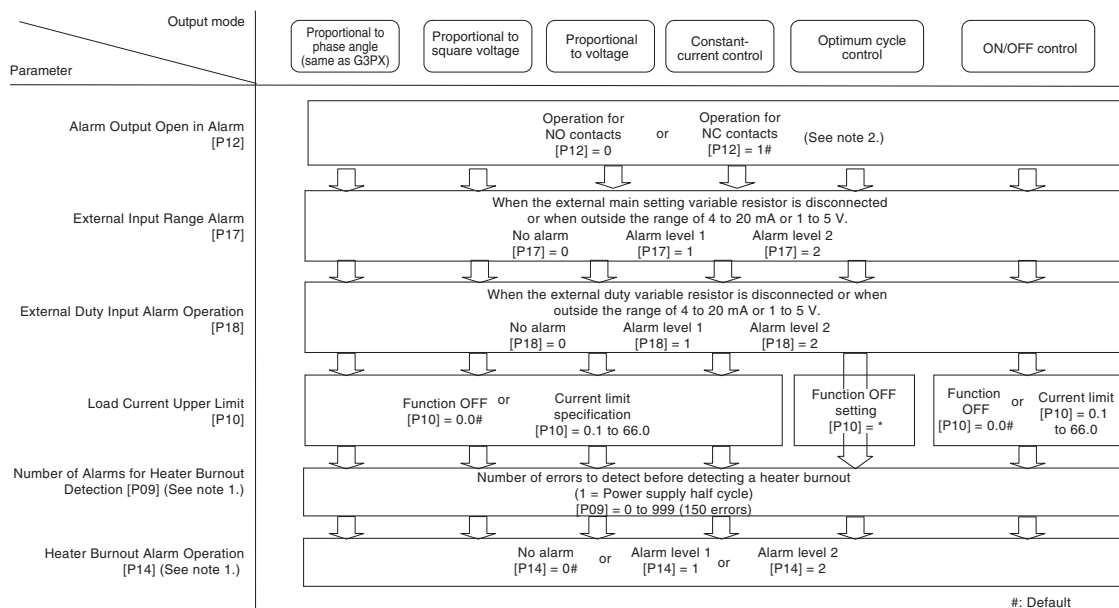

#: Default  
\*: Setting disabled  
**Note 1:** Constant-current Models only.  
**Note 2:** The alarm status is not determined for 1 s after startup.



Output mode Parameter	Proportional to phase angle (Same as G3PX)	Proportional to square voltage	Proportional to voltage	Constant connect control	Optimum cycle control	ON/OFF control
SSR Short circuit detection [P29]	Enabled [P29]=1# or Disabled [P29]=0					
SSR Open failure [P30]	Enabled [P30]=1# or Disabled [P30]=0					
CT failure [P31] *1	Enabled [P31]=1# or Disabled [P31]=0					

#: Default  
\*1: Only constant current control type.

**Note 1:** [P29] [P30] [P31] can set the version after Ver 1.1.  
**Note 2:** Please note that we shall not be responsible for the occasion due to changing parameter.  
 Consider offset or provision after changing parameter in reference to test operation.



## **SECTION 5**

# **Descriptions of Functions**

This section describes the functions you can use when operating the G3PW Power Controllers.

5-1	External Contact Input Functions . . . . .	50
5-2	Inputting the Main Setting with an External Variable Resistor . . . . .	53
5-3	Duty Setting . . . . .	54
5-4	Base-up Function . . . . .	56
5-5	Output Limits . . . . .	57
5-6	Soft-start Up and Soft-start Down Functions . . . . .	58
5-7	Load Current Limit (Constant-current Models Only). . . . .	59
5-8	Monitoring Total Run Time . . . . .	60
5-9	Heater Burnout Detection (Constant-current Models Only). . . . .	61

## 5-1 External Contact Input Functions

There are two external contact inputs: the event input (terminals 11 and 12) and reset input (terminals 13 and 14).

### Event Inputs

The event input (terminals 11 and 12) is an external contact input that can be used for one of the following functions:

- Switching the control method between phase control and optimum cycle control
- Switching between automatic and manual operation selection

In the initial setting level, set the Event Input Assignment parameter [P11] as follows to assign one of the above functions to the event input.

P11 setting	Meaning	Function of event input
0	No assignment	Does not function as event input.
1	Control method selection	Switches between phase control and optimum cycle control.
2	Automatic/manual selection	Switches between automatic and manual operation.

### When Not Using the Event Input

Set the parameter to 0 (No assignment). The event input will not function regardless of its open/closed status.

**Note** If a setting other than 0 (No assignment) is selected, the control method and automatic/manual operation will be switched according to the status of the event input. If you are not using the event input, always set the parameter to 0: *No assignment*.

### Selecting the Control Method with the Event Input

Set the parameter to 1 (control method selection). The event input can be used to switch between the following control methods.

- Phase control
- Optimum cycle control

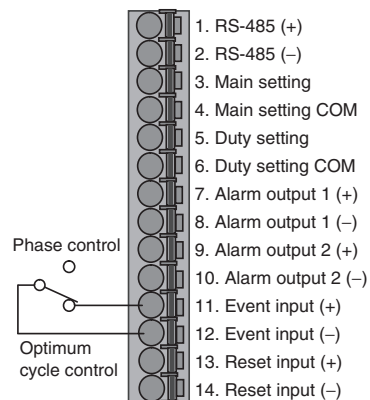

For standard models, 1 and 2 are not used.

Event input status	Meaning
Open	Phase control
Closed	Optimum cycle control

- Note**
- (1) When constant-current control is set as the output mode for phase control, constant-current control is always used and the control method cannot be switched by using the event input.
  - (2) When 1 (control method selection) is set for the Event Input Assignment parameter [P11], the Control Method Selection (TYP) will not be displayed. In addition, if the Control Method Selection parameter is changed by using communications, an operation error response will be returned.

**Switching between Automatic and Manual Operation with the Event Input**

Set the parameter to 2 (automatic/manual selection). The event input can be used to switch between automatic and manual operation as shown below.

Automatic operation	The input value is set by the linear input (4 to 20 mA or 1 to 5 V) or by using communications.
Manual operation	The input value is set by the external variable resistor or by key operation.

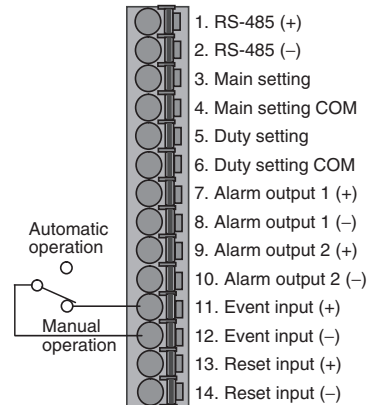

Event input status	Meaning
Open	Automatic operation
Closed	Manual operation

For standard models, 1 and 2 are not used.

**Note** When 1 (control method selection) is set for the Event Input Assignment parameter [P11], the Control Method Selection (TYP) will not be displayed. In addition, if the Control Method Selection parameter is changed by using communications, an operation error response will be returned.

**Alarm Reset**

If any of the following alarms occurs, it can be cleared by using the reset input.

- SSR short circuit detection (E10 flashing)\* on or after Ver 1.1.
- SSR open failure detection (E11 flashing)\* on or after Ver 1.1.
- CT failure detection (E12 flashing)\* on or after Ver 1.1.
- Overcurrent error (E20 flashing)
- Zero cross error (E30 flashing)
- Frequency error (E31 flashing)
- Heater burnout alarm (E40 flashing)
- External input range alarm (E50 flashing)
- External duty input alarm (E51 flashing)
- Total run time alarm (E60 flashing)

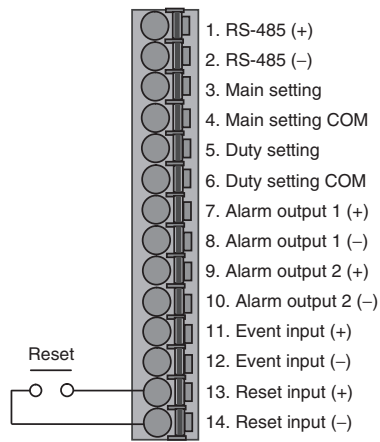

Alarms can also be cleared by using the ENT/RST Key on the front of the Power Controller.

For standard models, 1 and 2 are not used.

## **5-2 Inputting the Main Setting with an External Variable Resistor**

The setting procedure shown here is for when the main setting is input by using an external variable resistor.

- 1,2,3...**
1. In the initial setting level, set the Event Input Assignment parameter [P11] to 0 (no assignment) or 1 (control method selection).
  2. In the initial setting level, set the Main Setting Automatic/Manual Default parameter [P08] to 1 (manual). If automatic or manual operation is selected using the event input, the setting for the event input will be given priority.
  3. Set the Main Setting Manual Input Selection [P06] to 0 (external variable resistor input).
  4. Use the ENT/RST Key to reset the Power Controller, and set the Main Setting Automatic/Manual Default parameter [P08] to Enable. If automatic or manual operation is selected using the event input, the Power Controller reset is not required.

## 5-3 Duty Setting

The duty setting function is used to set the rate of change from 0% to 100% of the output value in relation to the input value (analog input signal, key input setting, or external variable resistor setting).

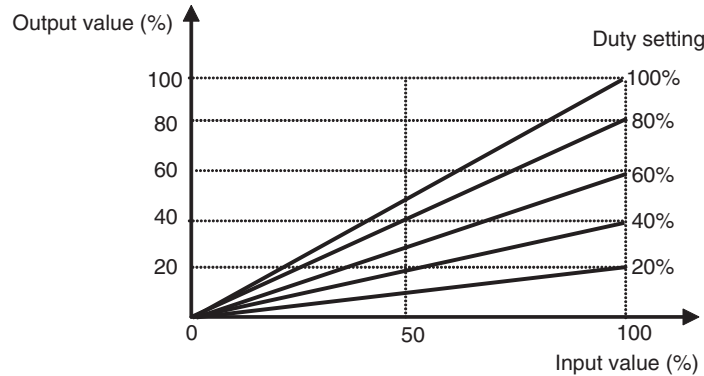

There are two duty settings, internal and external. The internal duty setting is held in the internal memory area and the external duty setting is set by using an external variable resistor. The duty that is used is the product of the internal and external duty settings.



$$\text{Duty value (\%)} = \text{Internal duty setting (\%)} \times \text{External duty setting (\%)}$$

- For example: In case Internal duty setting = 80%,  
External duty setting = 50%,  
duty value = 80% × 50% = 40%.

### Internal Duty Setting

- The internal duty setting is made using either key inputs or communications (Constant-current Models only).
- The duty setting is held in the internal memory area even when the power is interrupted.
- The duty is set in the adjustment level (DTY).

Example: Setting the internal duty value to 80%

1. Press the LVL Key once in the monitor level (running) state to move to adjustment level. The "ADJ" LED lights up.
2. Press the DOWN Key  once to display DTY (duty setting), and enter with the ENT/RST key.
3. Press the UP and DOWN Keys   to display 80,0 and enter with the ENT/RST key.
4. Press the LVL Key once to return to monitor level. The "ADJ" LED turns off.

### External Duty Setting

- The external duty setting is made using an external variable resistor.
- To use the external duty setting function, set the External Duty Input Enable/Disable parameter [P01] to 1 (enable) in the initial setting level.



**Relation between Input Values and Outputs in Each Output Mode**

**1. Control Proportional to Phase Angle (Same as G3PX)**

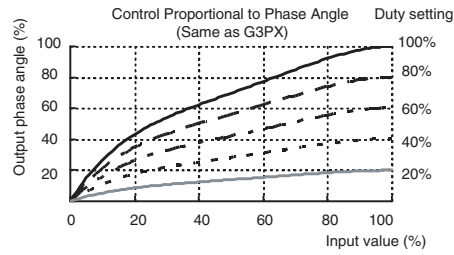

**2. Control Proportional to Square Voltage**

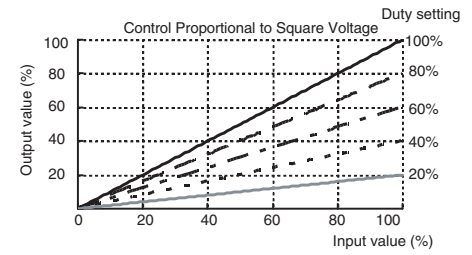

**3. Control Proportional to Square Voltage**

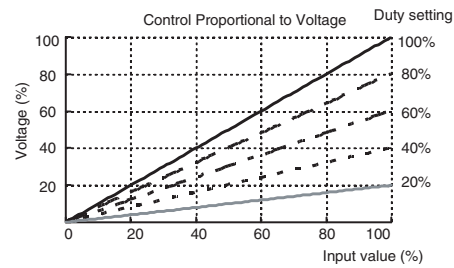

**4. Constant-current Control \***

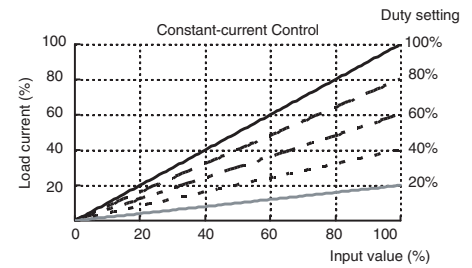

\* In case G3PW-A245EC-C-FLK be used, full scale (FS) is 45 A.  
 If maximum current is confined 18 A, set the duty value 40%.  
 $45 \text{ A} \times 40\% = 18 \text{ A}$ .

## 5-4 Base-up Function

The base-up function increases the output value so that it does not become 0% even when the input value is 0%. Because the output value is held even when the input value is 0%, the heater can be preheated. This is effective for shortening the heating time when using a load for which the temperature increases slowly.

The base-up value is set in the Base-up Value (BUP) parameter in the adjustment level or by using communications (Constant-current Models only).



Base-up value setting range	0.0% to 100%
-----------------------------	--------------

The output value is found with the following formula.

$$\text{Output value} = \text{Duty setting} \times \text{input value} + \text{Base-up value}$$

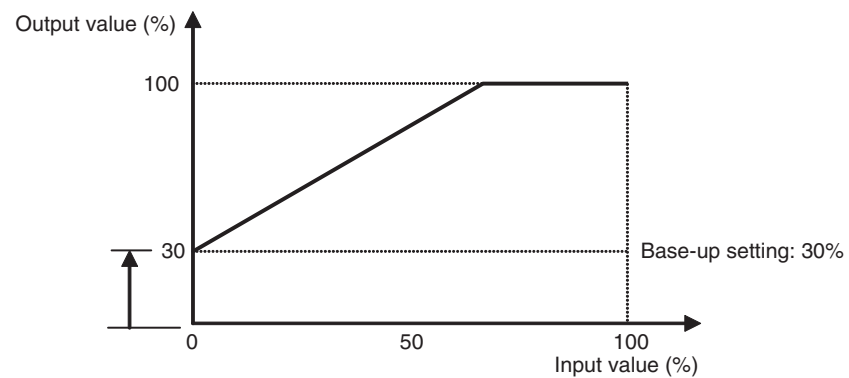
### ■ Example: Setting the Base-up Value to 30%



- 1,2,3...**
1. While in the monitor level (during operation), press the LVL Key once to move to the adjustment level.
  2. Press the DOWN Key  for 2 s to display the BUP (base-up value), and press the ENT/RST Key to enter the value.
  3. Use the UP and DOWN Keys   to display 30.0, and then press the ENT/RST Key to enter the value.
  4. Press the LVL Key once to return to the monitor level.

## 5-5 Output Limits

The output limit function can be used to set upper and lower limits for the output value. The output value is found with the following formula:

$$\text{Output value} = \text{Duty setting} \times \text{Input value} + \text{Base-up value}$$





The output limit is set in the Output Upper Limit (OLU) and Output Lower Limit (OLL) parameters in the adjustment level, from 0.0% to 100% in each case.

If the output lower limit is set higher than the output upper limit, then the output lower limit will be used as the output upper limit, and the output upper limit will be used as the output lower limit. In other words, the higher value will always be taken as the upper limit, and the lower value will always be taken as the lower limit.

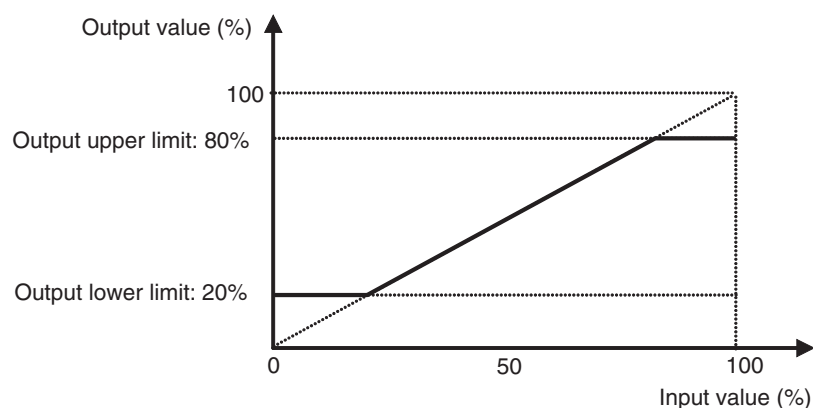
Parameter	Setting range (%)	Default (%)
Output Upper Limit (A06)	0.0 to 100	100
Output Lower Limit (A07)	0.0 to 100	0.0

Example: Setting the output upper limit / lower limit value to 80%/20%



1. Press the LVL Key once in the monitor level (running) state to move to adjustment level. The "ADJ" LED lights up.
2. When upper limit is selected with the DOWN Key : Display 5 (OLU: output quantity, upper limit) and enter with ENT/RST key. When lower limit is selected: Display 6 (OLL: output quantity, lower limit) and enter with ENT/RST key.
3. Press the UP and DOWN Keys   to select OLU to display 80,0 and enter with the ENT/RNT key.  
You will return to the OLO display. Press the DOWN Key  to display OLL and enter with the ENT/RST key, and then display 20.0 in the same way and enter with the ENT/RST key.
4. Press the LVL Key once to return to the monitor level. The "ADJ" LED turns off.

## 5-6 Soft-start Up and Soft-start Down Functions

The soft-start up and soft-start down functions are used to change the output value gradually within a set rate of change, even when the input value changes suddenly. You can set the time for the output value to go from 0% to 100% (i.e., the SUP (soft-start up time)) and the time for the output value to go from 100% to 0% (i.e., the SDN (soft-start down time)) to a value from 0.0 to 99.9 s.

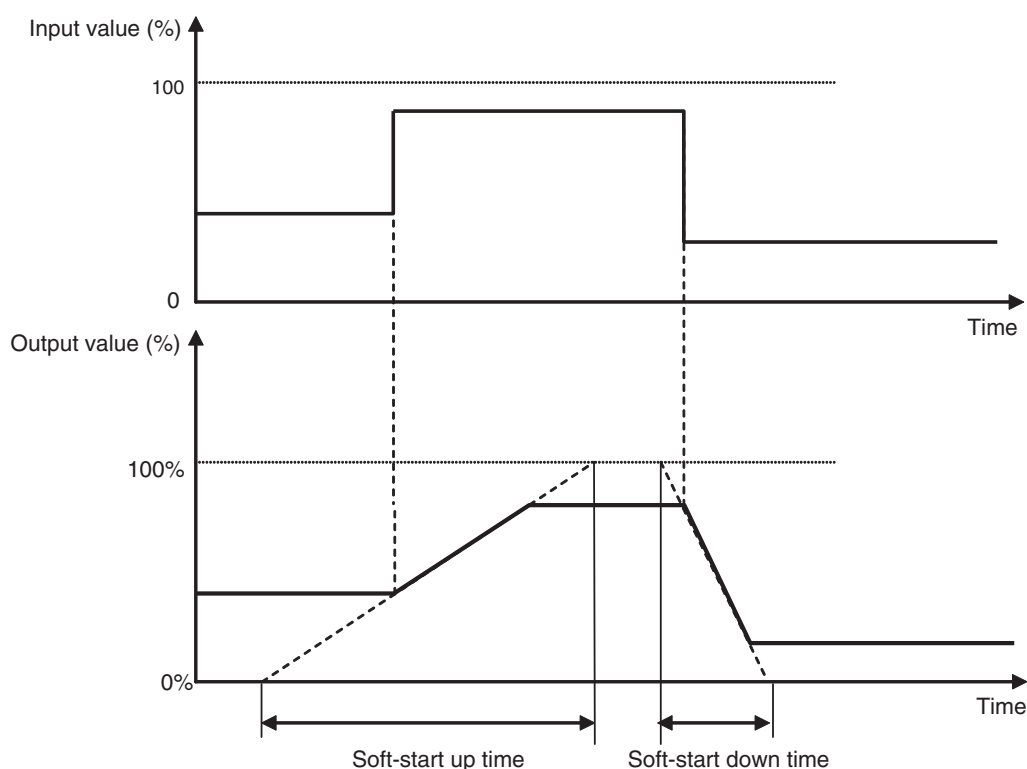

Parameter	Setting range (s)	Default (s)	Meaning
Soft-start Up Time (SUP)	0.0 to 99.9	0.5	The time for the output value to go from 0% to 100%.
Soft-start Down Time (SDN)	0.0 to 99.9	0.0	The time for the output value to go from 100% to 0%.

- Relationships between Input and Output Values and Soft-start Up and Down Times



**⚠ Caution** Specify the soft-start up time so that the inrush current will not be too large. If the soft-start up time is set too low, the inrush current cannot be suppressed and the load may be damaged.

Example: Changing the Soft-start Up time to 5 seconds

1. Press the LVL Key once in the monitor level (running) state to move to adjustment level. The "ADJ" LED lights up.
2. Press the DOWN Key  three times to display SUP (Soft-start Up time), and enter with the ENT/RST key.
3. Press the UP and DOWN Keys   to display 5.0 and enter with the ENT/RST key.
4. Press the LVL Key once to return to the monitor level. The "ADJ" LED turns off.

## 5-7 Load Current Limit (Constant-current Models Only)

The load current limit function is used to measure the load current with the built-in CT and to limit the load current by adjusting the output phase angle so that the load current does not exceed the value set in the Load Current Upper Limit parameter [P10].

Setting range	0.0 to 66.0 (A)
---------------	-----------------

- The load current upper limit is set in the Load Current Upper Limit parameter [P10] in the initial setting level.
- This function can be used with Constant-current Models only.
- When this function is being used, the output value that is actually output will be smaller than the output value that is calculated based on the input value.
- The following example shows the load current limit function used when the maximum load current is 20 A.

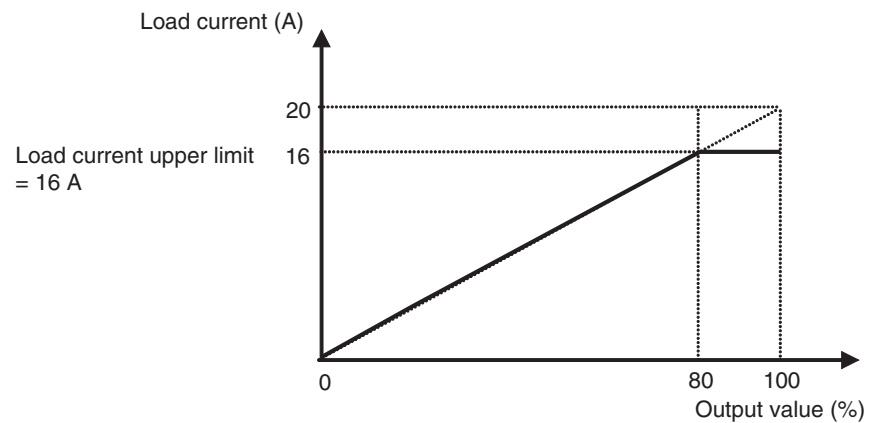



**⚠ Caution** The load current limit function cannot be used to suppress the inrush current for loads with a large inrush current. For loads with a large inrush current, use the load current limit function together with the soft-start up function to suppress the inrush current. The response time that is required before the load current can be suppressed is 500 ms max.

\* This function cannot behave during optimum cycle control [P07=1].

This function is workable during proportional to phase angle control [P07=0].

Example: Setting the load current upper limit to 16 A when using the G3PW-A220EC-S-FLK.

1. Long-press (at least 2 seconds) the LVL Key to move to the initial setting level. The "SET" LED lights up.
2. Display P10 (load current upper limit) with the DOWN Key , and enter with the ENT/RST key.
3. In the case of the G3PW with 20 A rating, change the setting to a value up to 20 A. This example is for setting 16 A, so press the UP and DOWN Keys   to display 16.0, and enter with the ENT/RST key.
4. Press the LVL Key once to return to the monitor level. The "SET" LED turns off.

## 5-8 Monitoring Total Run Time

The total run time monitor function is used to calculate the total time that power is ON to the G3PW Power Controller and to output an alarm when the time reaches the preset value in the Total Run Time Alarm Set Value parameter [P16]. This function can be used for maintenance and managing equipment by presetting replacement times for devices, such as heaters, in the Total Run Time Alarm Set Value parameter.

Operation during an alarm output is set in the Total Run Time Exceeded Operation parameter [P15] in the initial setting level.

P15 setting		Meaning
0	No operation	The alarm does not operate.
1	Alarm level 1	An alarm is output to the ALARM1 contacts and operation is stopped.
2	Alarm level 2	An alarm is output to the ALARM2 contacts and operation continues.

The total run time exceeded alarm is set in the Total Run Time Alarm Set Value parameter [P16] in the initial setting level.

<b>P16 setting range</b>	0.0 to 99.9 kh (0.0: Operation stopped)
--------------------------	---

The total run time is cleared by the Initialize Set Values parameter [P27] in the initial setting level.

P27 setting	Meaning
0	Do not initialize.
1	Initialize

Use the Total Run Time Monitor parameter (POT) in the monitor level to monitor the present total run time.

## 5-9 Heater Burnout Detection (Constant-current Models Only)

### Overview

The heater burnout detection function is used to compare a preset heater resistance value with the estimated resistance during operation to detect a “burnout” and output an alarm if the resistance during operation rises above the criteria.

The present resistance is estimated based on the present output value and the current detected by the built-in CT.

**Note** The accuracy of heater burnout detection will be lower for heaters for which the resistance significantly changes depending on the temperature. If the rate of change in the heater resistance exceeds the criteria for detecting a heater burnout, a false heater burnout will be detected. The criteria for detecting a heater burnout is set in the Heater Burnout Threshold parameter (HBR).

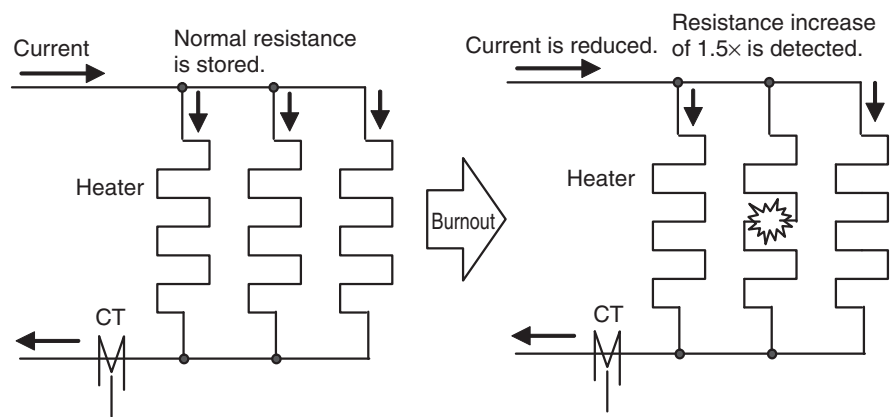

### Relationship between Parameters and Resistance

The following diagram shows the relationship between the heater burnout detection parameters and the resistance.

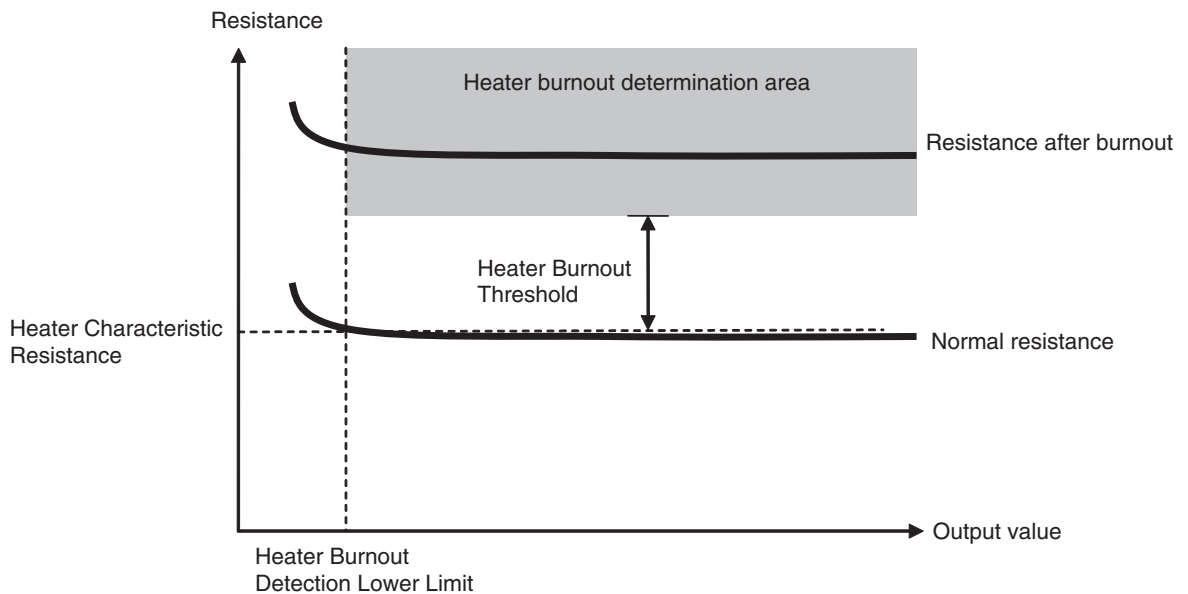

### Basic Parameters

Before the heater burnout detection function can be used, the following two parameters must be set.

- Heater Burnout Alarm Operation [P14] (in initial setting level)

- Heater Characteristic Resistance (HPR or HCR) (in adjustment level)

**Setting the Operation for When a Heater Burnout Alarm Occurs**

To use the heater burnout detection function, set the Heater Burnout Alarm Operation parameter [P14] to a value other than 0 in the initial setting level.

P14 setting	Meaning	Description
0	No operation	Heater burnout detection does not operate.
1	Alarm level 1	Heater burnout detection functions at alarm level 1.
2	Alarm level 2	Heater burnout detection functions at alarm level 2.

**Heater Characteristic Resistance**

The heater characteristic resistance is the value equivalent to the combined resistance of the connected heater loads.

**Note** The power supply voltage is assumed to be 100 V. When the power supply voltage is 200 V, the heater characteristic resistance will be one half of the actual combined resistance.

$$\text{Heater characteristic resistance} \cong \text{Combined resistance} \times (100/\text{Power supply voltage})$$

The heater characteristic resistance can also be set directly, but it is recommended that it first be set using the teaching function.

Accurate heater characteristic resistance can be easily set by using the Teach Heater Characteristics for Phase Control (TPC) or Teach Heater Characteristics for Optimum Cycle Control (TCC) parameters in the adjustment level.

**Teaching Operations in the Adjustment Level**

When teaching is executed, the present resistance is automatically used as the heater characteristic resistance.

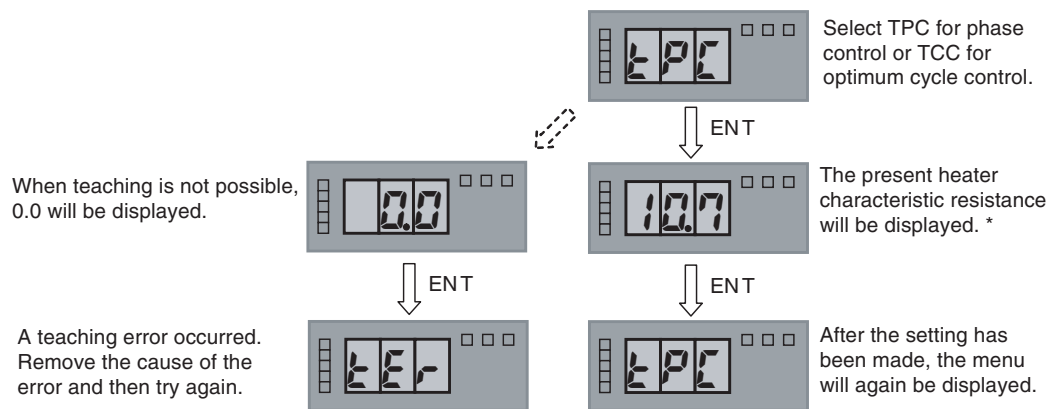

The present heater characteristic resistance can be retrieved using communication facility during G3PW working. (On or after Ver 1.1)

Teaching cannot be executed when the current flowing to the CT is less than 10% of the rated current. Perform teaching only when the current is at least 10% of the rated current and when control is stable.

Display	Name	Operation
TPC	Teach Heater Characteristics for Phase Control	Sets the present resistance as the heater characteristic resistance for phase control.
TCC	Teach Heater Characteristics for Optimum Cycle Control	Sets the present resistance as the heater characteristic resistance for optimum cycle control.



To set the parameter directly without teaching or to make an adjustment after teaching, select the Heater Characteristic Resistance parameter (HPR or HCR).

Display	Name	Range
HPR	Heater Characteristic Resistance for Phase Control	0.0 to 99.9
HCR	Heater Characteristic Resistance for Optimum Cycle Control	0.0 to 99.9

Using teaching heater characteristic for heater burnout detection during optimum cycle control, parameter [P02] should be set except 3.

\* If [P07] = 1, [P02] = 3, "TCC: Teach Heater characteristic" is not indicated.

		[P07]	
		0	1
[P02]	0	Available	Available
	1	Available	Available
	2	Available	Available
	3	Available	Not available

**Parameters for Heater Burnout Judgment Conditions**

The following parameters are used to set the conditions for detecting a heater burnout. Use them according to the load environment.

- Heater Burnout Threshold (HBR): Adjustment level
- Heater Burnout Detection Lower Limit (HBL): Adjustment level
- Number of Alarms for Heater Burnout Detection [P09]: Initial setting level

**Rate of Change in Resistance for Heater Burnout Detection**

The threshold for determining a heater burnout when the resistance increases must be set as a percentage of the present resistance using the Heater Burnout Threshold parameter [HBR]. The following formula is used to determine heater burnouts.

$$\text{Present resistance} \geq \text{Characteristic resistance of heater} \times \frac{100}{100 - \text{Heater Burnout Threshold}}$$

An approximate value for the Heater Burnout Threshold can be calculated with the following formula.

$$\text{Heater Burnout Threshold} = 90 \div \text{Number of heater elements}$$

For example, if you want to detect the burnout of one element for a heater with three elements, set the Heater Burnout Threshold to 30.

**Note**

- (1) If the default value of 100 is used, burnout of all heater elements will be detected.
- (2) If the Heater Burnout Threshold is too small, the alarm output may be unstable.

Display	Name	Range
HBR	Heater Burnout Threshold	1 to 100

**Heater Burnout Detection Lower Limit**

The Heater Burnout Detection Lower Limit parameter is used to limit the range of output values for heater burnout detection. The default setting is 0.0. If alarms are frequently occurring for small outputs in normal operation, then limit the range of output values to be detected.

Display	Name	Range
HBL	Heater Burnout Detection Lower Limit	0.0 to 100

**Number of Alarms for Heater Burnout Detection**

The Number of Alarms for Heater Burnout Detection parameter is used to set the number of cycles for which heater burnout is to continue until an alarm will be output. The default setting is 150. 1 cycle is half cycle of power supply frequency.

Display	Name	Range
[P09]	Number of Alarms for Heater Burnout Detection	0 to 999

**Note** If a number of 10 or lower is set for the Number of Alarms for Heater Burnout Detection parameter, the alarm may operate incorrectly with a sudden change in the MV.

**Parameter Settings Flowchart**

Set each parameter correctly in order for heater burnout to be clearly detected and to avoid false detections.

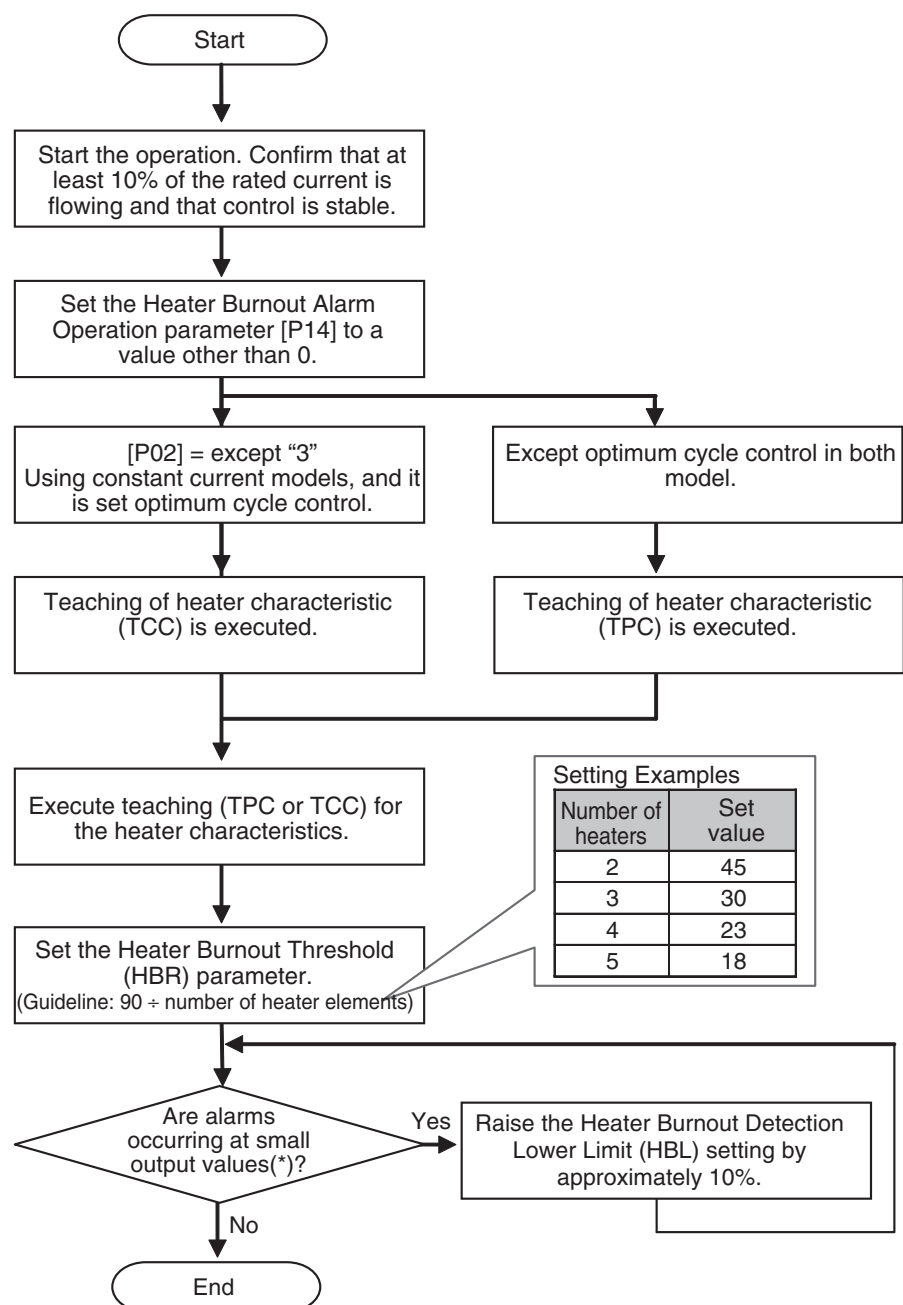

\* Example of load what is high resistance at ordinary ambient temperature.

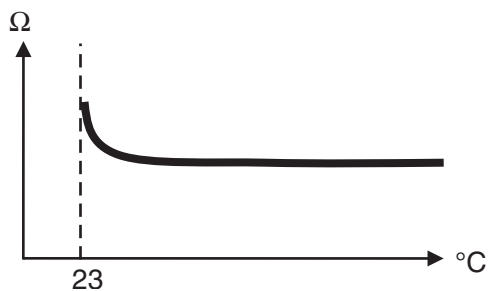



# SECTION 6

## CompoWay/F Communications

This section provides information on using CompoWay/F communications.

6-1	Communications Settings . . . . .	68
6-1-1	Introduction . . . . .	68
6-1-2	Communications Settings . . . . .	68
6-1-3	Connection Example . . . . .	72
6-2	Frame Configuration . . . . .	77
6-3	FINS-mini Text . . . . .	79
6-4	Services and Addresses . . . . .	80
6-5	Variable Area Write . . . . .	84
6-6	Variable Area Read . . . . .	85
6-7	Operation Command . . . . .	88
6-8	Controller Attribute Read . . . . .	89
6-9	Controller Status Read . . . . .	90
6-10	Echo-back Test . . . . .	91
6-11	ASCII Table . . . . .	92

## 6-1 Communications Settings

### 6-1-1 Introduction

G3PW Constant-current Models can perform serial communications with EJ1 Modular Temperature Controllers or SYSMAC CS/CJ/CP-series PLCs. The CompoWay/F communications protocol is used. CompoWay/F is a generic serial communications protocol from OMRON. An RS-485 interface is used at the G3PW.

#### Communications Specifications

<b>Transmission path connections</b>	Multipoint
<b>Communications method</b>	RS-485 (2-wire, half-duplex)
<b>Sync method</b>	Stop-start sync
<b>Baud rate</b>	9.6, 19.2, 38.4 or 57.6 kbit/s
<b>Transmission code</b>	ASCII
<b>Data length</b>	7 or 8 bits
<b>Stop bits</b>	1 or 2 bits
<b>Error detection</b>	Vertical parity: None, even, or odd
<b>Flow control</b>	None

**Note** CompoWay/F

CompoWay/F is OMRON's standard communications format for general serial communications.

It uses commands compliant with the well-established FINS used extensively with OMRON Programmable Controllers together with a consistent frame format to facilitate communications between more than one component and between personal computers and components.

FINS (Factory Interface Network Service)

The FINS protocol provides message communications between controllers in OMRON FA networks.

### 6-1-2 Communications Settings

This section describes the communications settings for the G3PW.

**Communications Settings in the Initial Setting Level**

Display	Parameter	Setting range	Default
P19	Communications Unit Number	0 to 99	1
P20	Communications Baud Rate	9.6: 9.6 k bit/s 19.2: 19.2 k bit/s 38.4: 38.4 k bit/s 57.6: 57.6 k bit/s	57.6 k bit/s
P21	Communications Data Length	7: 7 bit 8: 8 bit	7 bit
P22	Communications Stop Bits	1: 1 bit 2: 2 bit	2 bit
P23	Communications Parity	none: None Even: Even odd: Odd	EVN: (EVEN)
P24	Send Wait Time	0 to 99 ms	1 ms
P25	Communications Main Setting Number	Connection to an OMRON EJ1 Modular Temperature Controller 0: Automatic assignment (recommended) (Default) 1: CH1 control output (heating) 2: CH2 control output (heating) 3: CH3 control output (heating) 4: CH4 control output (heating) 5: CH1 control output (cooling) (See note.) 6: CH2 control output (cooling) (See note.) 7: CH3 control output (cooling) (See note.) 8: CH4 control output (cooling) (See note.)	0
		Connection to an OMRON PLC 1: Automatic assignment (Fixed)	1
P26	Communications Timeout Time	0: Communications timeout function disabled 0 to 999 s	10 s

- Note**
- (1) Refer to 6-4 Services and Addresses for the notation used for set values in communications.
  - (2) The following MV will be sent from the EJ1 to the G3PW Unit regardless of whether the control method is set to standard or heating/cooling control. The MV (manipulated variable) sent from the EJ1 is used as the input variable by the G3PW.

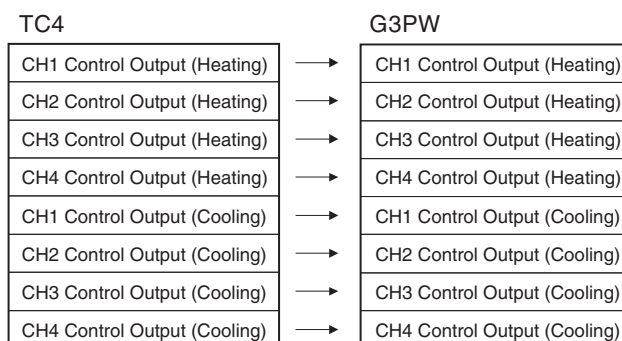

- When standard control is being used, the Channel 1 to 4 control outputs for cooling are set to 0.0%.
- With a TC2, the Channel 3 and 4 control outputs for heating and cooling are set to 0.0%.

**Other Settings**

The following parameters must be set to write the MV (manipulated variable) to the G3PW via communications.

Display	Parameter	Setting range
P04	Input Signal Type	0: Linear input
P05	Main Setting Automatic Input Selection	1: Communications
P08	Main Setting Automatic/Manual Default	0: Automatic (See note.)
P11	Event Input Assignment	0: No assignment 1: Control method selection (See note.)

**Note** You can use external contacts to switch between manual input (using an external variable resistor or key input) and communications. Set the Event Input Assignment parameter [P11] to 2 (main setting automatic/manual selection).

**Moving to the Communications Parameters in the Initial Setting Level**

Move to the communications settings in the Initial Setting Level by performing the following procedure with the keys on the front panel.

**Procedure**

- 1,2,3...
- When the power is turned ON, the 7-segment display, level indicators, monitoring indicators, and communication indicator will all light and then the current input value for the MV will be displayed on the 7-segment display. Confirm this status.

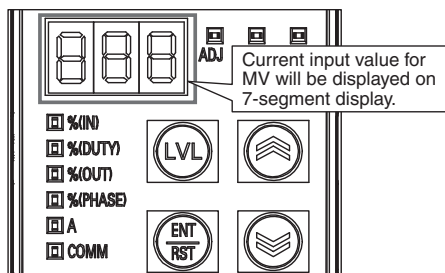

- Press the Level Key for at least 2 seconds. The Power Controller will move from Run Mode to Initial Setting Mode and "P01" will be displayed on the 7-segment display.

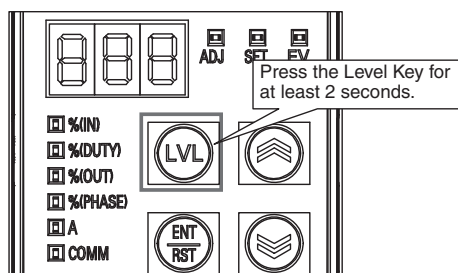



- Press the Up Key or Down Key repeatedly until the desired parameter is displayed. Parameters [P20] to [P26] contain the communications settings.

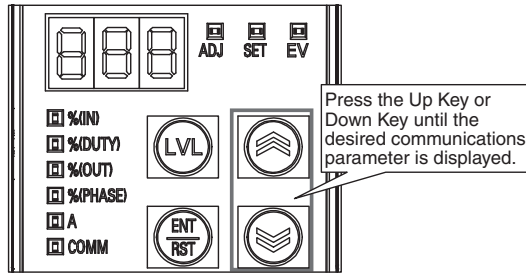

The setting of the parameters can be read and changed as required.

**Moving to Communications Parameters**

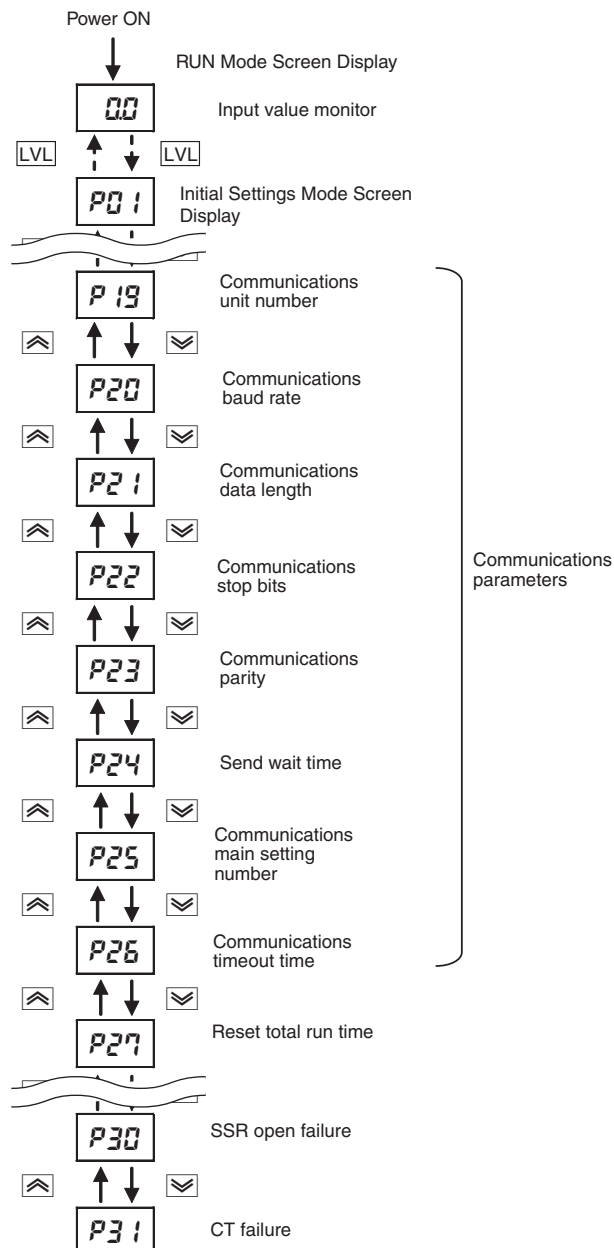

**Example: Setting Communications Parameters**

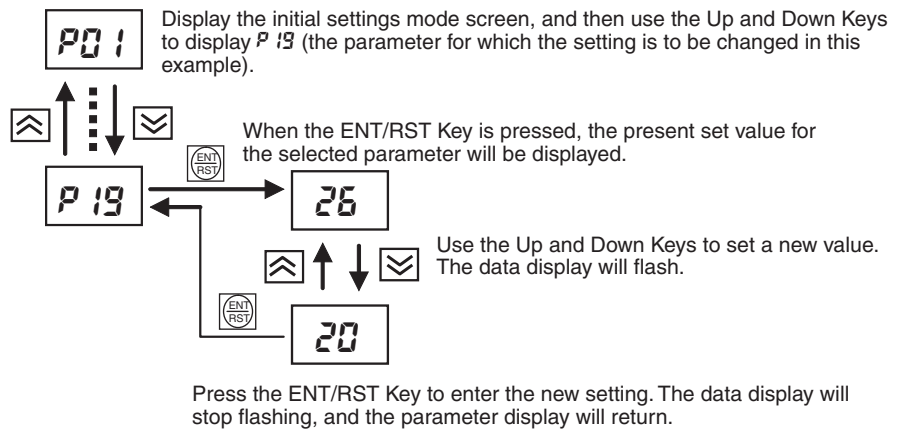

**6-1-3 Connection Example**

**Setting the G3PW Communications Unit Numbers to the Same Numbers as the EJ1 Channel Numbers**

An EJ1 TC4 Unit has four channels. It can thus be connected to up to four G3PW Power Controllers.

**Setting Example**

- 1,2,3... 1. The G3PW communications unit numbers [P19] can be set to the same numbers as the EJ1 channel numbers, as shown below.

2. Set the Communications Main Setting Number parameter [P25] to the default value (0: Automatic assignment). The EJ1 will create communications frames for the MVs for the maximum number of channels (i.e., four channels for the TC4 Unit). The Communications Main Setting Number parameter of the G3PW is set to specify automatic assignment, so the channel number for the MV will be the same as the communications unit number for each channel.

Communications Main Setting Number: Automatic Assignment

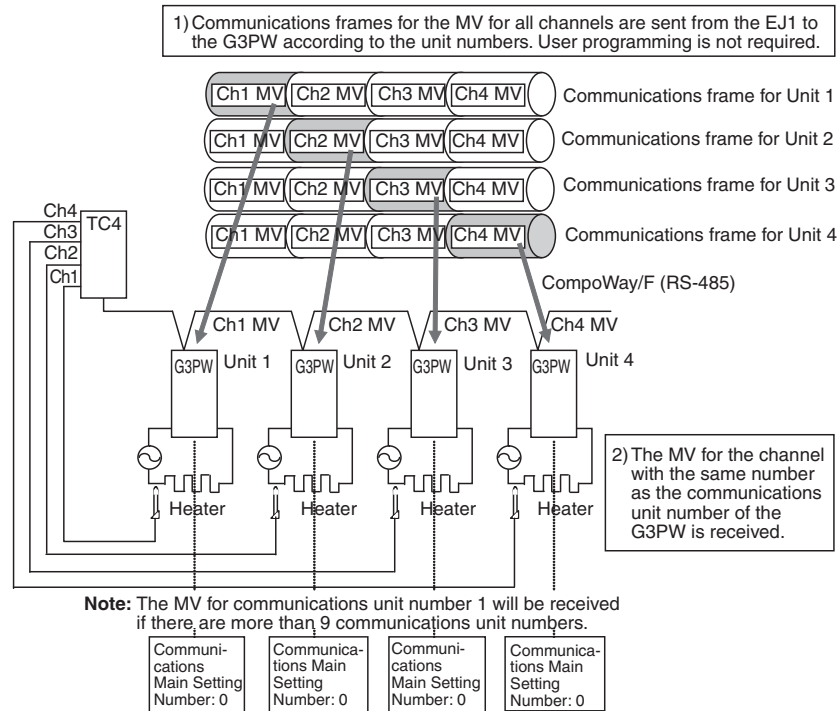

**Note** Refer to the note on page 76 for information on the Communications Main Setting Numbers.

**Note** The EJ1 will automatically send the MV for the maximum number of G3PW channels. User programming is not required.

- The CompoWay/F communications frame sent from the EJ1 for G3PW communications unit 2 is shown below.

[STX]02000010281000000008	03E6	01F4	0064	0032	0000	0000	0000	0000
	(1)	(2)	(3)	(4)	(5)	(6)	(7)	(8)

**Note** (1) to (8) are the channel numbers. When the G3PW communications channel number is set to 2, the MV for channel 2 is obtained. (The number of the EJ1 channel is the same as the G3PW channel number.)

### Setting Any G3PW Communications Unit Numbers for the EJ1 Channel Numbers

The EJ1 channel number from which to receive the MV can be set as desired for each communications unit number.

- 1,2,3... 1. Set any communications unit numbers [P19] for the G3PW Power Controllers.

- Set the Communications Main Setting Number parameter [P25] to any number between 1 and 8. The G3PW with each communications unit number will receive the MV from the Temperature Controller channel specified by the Communications Main Setting Number.

Communications Main Setting Number: Specific Settings

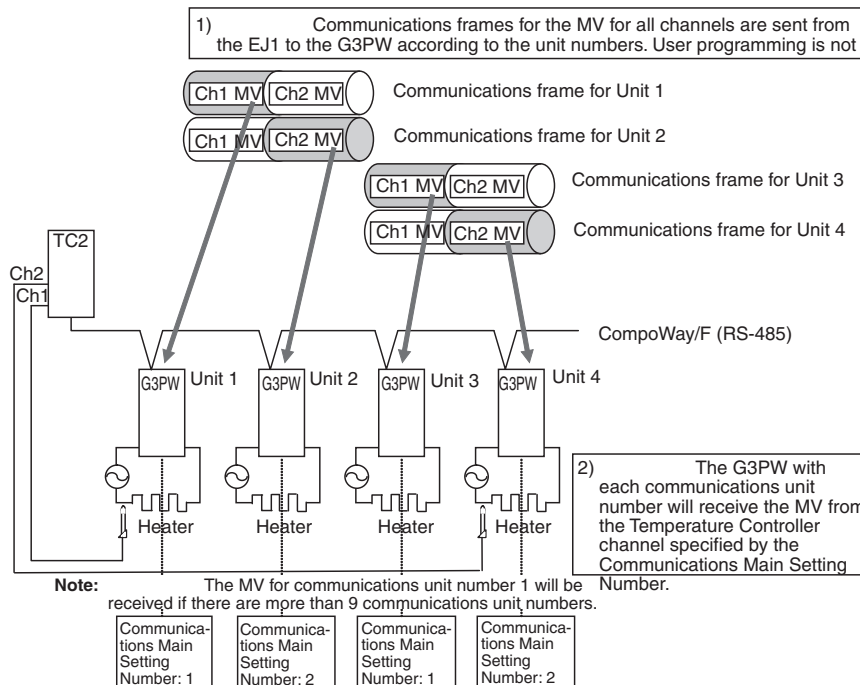

**Note** Refer to the note on page 76 for information on the Communications Main Setting Numbers.

**Note** The EJ1 will automatically send the MV for the maximum number of G3PW channels. User programming is not required.

### Connecting to a Serial Communications Unit/Board in a PLC

The following settings are necessary to connect a PLC and G3PW Power Controllers with serial communications. RS-485 is used for communications, so up to 31 G3PW Power Controllers can be connected.

#### G3PW Settings

- 1,2,3...
- Set all of the Communications Main Setting Number parameters [P25] to 1.
  - Set the communications unit numbers to any values between 0 and 99. (A maximum of 31 nodes can be connected.)

#### PLC Settings

Use the CMND instruction in the ladder program to send input variables to the G3PW Power Controllers. Use a variable type of C1/81 and an address of 0000 for the communications main setting (MV) for each G3PW communications unit number.

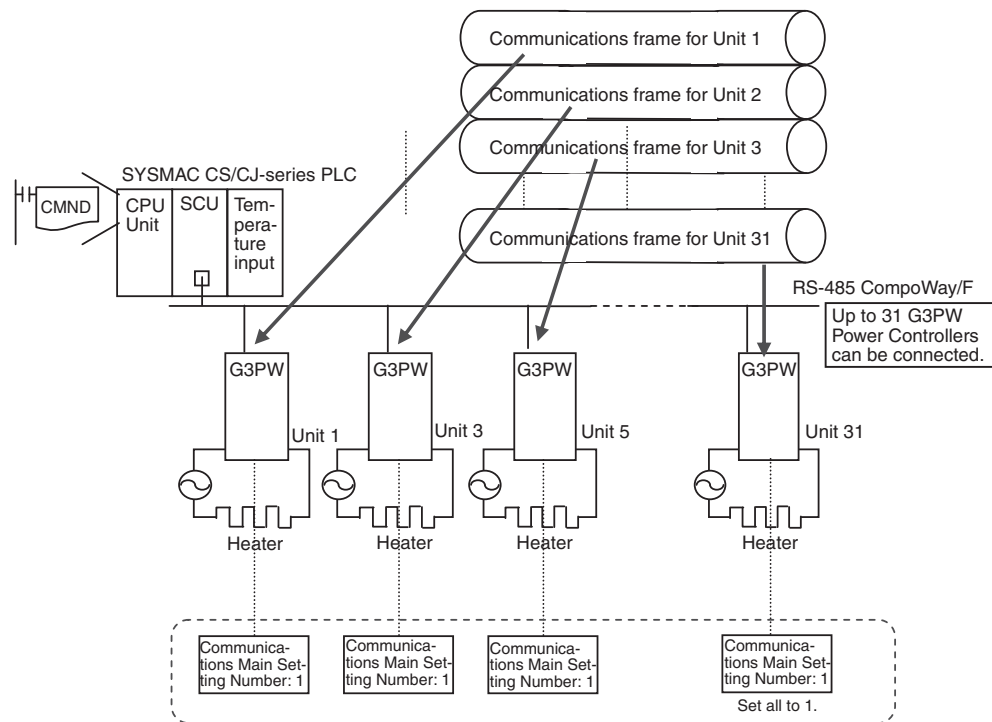

**Note** Refer to the note on page 76 for information on the Communications Main Setting Numbers.

Example: The communications frames are given in the following table when G3PW Power Controllers with communications unit numbers 1, 3, and 5 are connected to the PLC.

CompoWay/F communications frame sent from the PLC	Operation
[STX]01000010281000000000103E6	Writes an MV of 03E6 to the G3PW with communications unit number 1.
[STX]03000010281000000000101F4	Writes an MV of 01F4 to the G3PW with communications unit number 3.
[STX]05000010281000000000100FA	Writes an MV of 00FA to the G3PW with communications unit number 5.

**Note** The shaded portions of the communications frames are the MVs.

**Note** Communications Main Setting Numbers  
 The Communications Main Setting Number is set in a G3PW Power Controller to specify the EJ1 channel from which the MV is to be received for the communications unit number.

As shown below, the communications frame sent by the EJ1 contains the MVs in the order of the channel numbers (MV for four channels for a TC4 Unit). The Communications Main Setting Number specifies the channel number from which the G3PW is to receive the MV as input data.

Normally, the Communications Main Setting Number parameter [P25] is set to specify automatic assignment so that the channel number will be the same as the communications unit number. (For example, the MV from channel 1 is received by the G3PW with communications unit number 1.) The Communications Main Setting Number can be set as desired to write the MV from channel 1 to the G3PW with any communications unit number from 2 to 4.

Connecting to an EJ1 Modular Temperature Controller  
 Set the Communications Main Setting Number [P25] to 0 (automatic assignment).

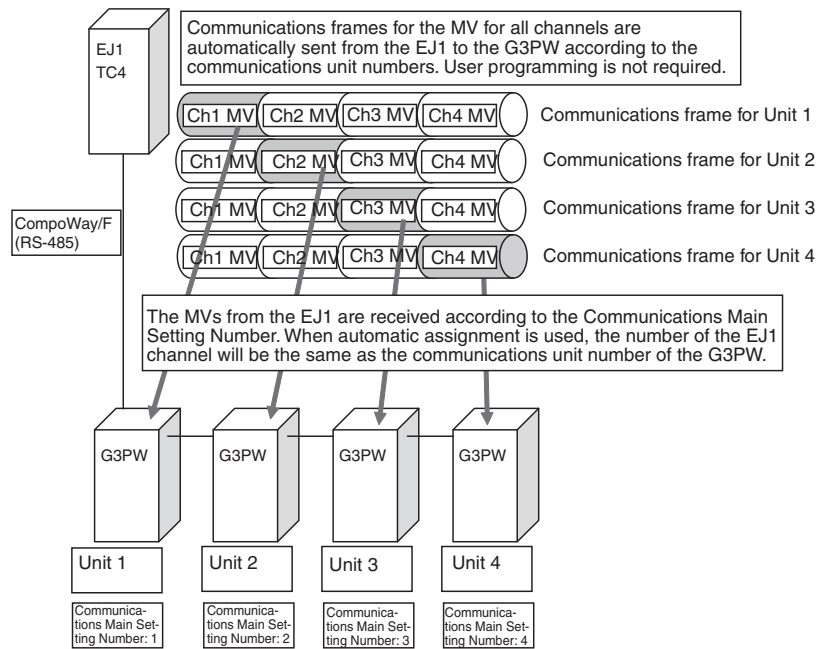

**Note** When connecting to a PLC, set the Communications Main Setting Number for all G3PW Power Controllers to 1.

**Send Wait Time**

The send wait time is used to adjust the time required for the host to switch from sending to receiving status. For the G3PW, this adjusts the time between creating a response after receiving a transmission and switching to send status.

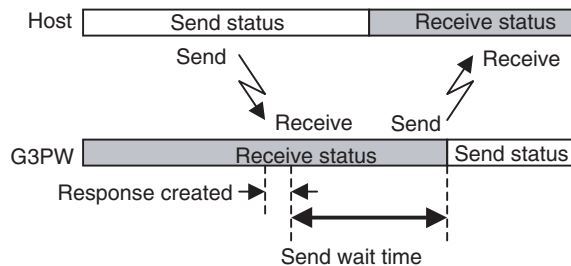

If switching time will not cause problems, the send wait time can be shortened to reduce the communications time with the host.

## 6-2 Frame Configuration

The communications protocol is the OMRON CompoWay/F protocol.

Commands from the host and responses from the G3PW are sent in data packets called frames. The structures of the command and response frames are shown below.

### Command Frame Format

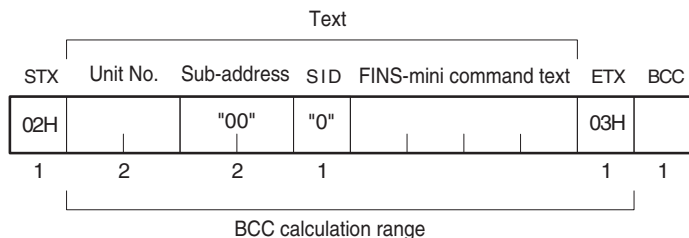

### Response Frames

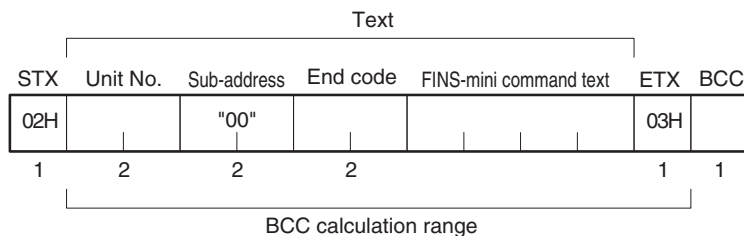

<b>STX</b>	This code indicates the beginning of the communications frame. Always set 02H.
<b>Unit. No.</b>	<ul style="list-style-type: none"> <li>• Set the unit number that is set on SW1 on the front of the G3PW.</li> <li>• No response will be received if another unit number is set.</li> </ul>
<b>Sub-address and SID</b>	Not used by the G3PW. Always set to "0".
<b>FINS-mini command text</b>	This text is the command. For details, refer to 6-3 <i>FINS-mini Text</i> .
<b>ETX</b>	This code indicates the end of the communications frame. Always set to 03H.
<b>BCC</b>	This stores the result of the BCC calculation from the Unit No. to EXT.

### BCC Calculation Example

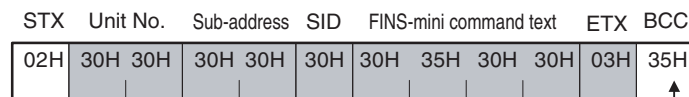

$$BCC = 30H \oplus 30H \oplus 30H \oplus 30H \oplus 30H \oplus 30H \oplus 35H \oplus 30H \oplus 30H \oplus 03H = 35H$$

⊕: XOR (exclusive OR) calculation

**Note** No response will be returned unless the frame contains all elements up to the ETX and BCC.

- The following notation is used for hexadecimal and ASCII text.

<b>Hexadecimal</b>	The suffix H is added after the number, e.g., 02H
<b>ASCII</b>	ASCII text is indicated inside quotation marks, e.g., "00".

**End Codes (CompoWay/F Communications)**

End code	Name	Description
"0F"	FINS command error	The specified FINS command could not be executed.
"10"	Parity error	The OR of 1 bits in received data does not match the setting for the communications parity.
"11"	Framing error	Stop bit is "0".
"12"	Overrun error	The next data was received when the reception data buffer was full.
"13"	BCC error	The calculated BCC value is different from the received BCC value.
"14"	Format error	The FINS-mini command text contains characters other than 0 to 9 and A to F. For details on the echoback test, refer to <i>6-10 Echo-back Test</i> . SID and the FINS-mini command text are not included.
"16"	Sub-address error	The sub-address is not included.
"18"	Frame length error	The received frame exceeds the required number of bytes.
"00"	Normal completion	Command processing was completed normally.



### 6-3 FINS-mini Text

The structure of FINS command and response text is shown below.

#### Command Text

An MRC (main request code) and SRC (sub-request code) followed by the various required data is transferred in the command frame.

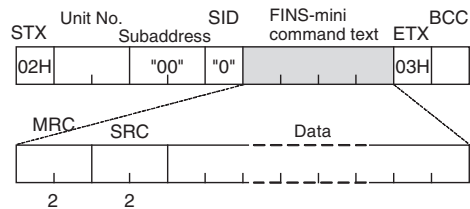

#### Response Text

The MRES (main response code) and SRES (sub-response code) are transferred in the response frame following the above MRC/SRC. Data is then transferred following the MRES and SRES.

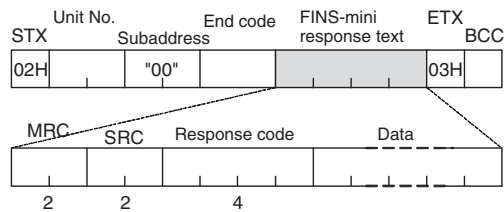

**Note** FINS (Factory Interface Network Service)  
 The FINS protocol provides message communications between controllers in OMRON FA networks. FINS-mini text is based on the FINS specifications.

## 6-4 Services and Addresses

### FINS-mini Command Services

MRC	SRC	Service	Description
01	01	Variable Area Read	Reads data from the variable area.
01	02	Variable Area Write	Writes data to the variable area.
05	03	Controller Attribute Read	Reads the model number and communications buffer size of the Controller.
06	01	Controller Status Read	Reads operating status.
08	01	Echo-back Test	Performs an echo-back test.
30	05	Operation Command	Performs operation commands, such as resetting and changing areas.

**Note** Service requests will not be accepted and no response will be returned if there is a RAM error or the Controller is in standby status. (Standby status exists from when power is turned ON until normal operation is possible.)

### Addresses

#### Variable Type CE/8E (Monitor Level Parameters)

Address		Data	Data range*	Notation
0000		Input Monitor	H'00000000 to H'000003E8	The data range is ten times the actual values.
0001		Internal Duty Monitor	H'00000000 to H'000003E8	
0002		Output Monitor	H'00000000 to H'000003E8	
0003		Phase Angle Monitor	H'00000000 to H'000003E8	
0004		Current Monitor	H'00000000 to H'000002EE	
0005		Total Run Time Monitor	H'00000000 to H'000003E7	Bit fields
0006		Status	H'00000000 to H'00000***	
On or after Ver 1.1	0007	Heater characteristic of resistance	H'00000000 to H'000003E7	The data range is ten times the actual values.
0007		Not used.	Always 0.	0
0008		Not used.	Always 0.	0
0009		Not used.	Always 0.	0
0010		Not used.	Always 0.	0
0011		Not used.	Always 0.	0
0012		Not used.	Always 0.	0
0013		Not used.	Always 0.	0
0014		Version	H'00000000 to H'00000***	1.23 = 00000123

\* The data ranges apply to all models of the G3PW.

**Variable Type C1/81 (Adjustment Level Parameters)**

Address	Data	Data range	Notation
0000	Communications Main Setting	H'00000000 to H'000003E8	The data range is ten times the actual values.
0001	Communications Main Setting		
0002	Communications Main Setting		
0003	Communications Main Setting		
0004	Communications Main Setting		
0005	Communications Main Setting		
0006	Communications Main Setting		
0007	Communications Main Setting		
0008	Internal Duty Setting	H'00000000 to H'000003E8	
0009	Base-Up Value	H'00000000 to H'000003E8	
000A	Soft-start Up Time	H'00000000 to H'000003E7	
000B	Soft-start Down Time	H'00000000 to H'000003E7	
000C	Output Upper Limit	H'00000000 to H'000003E8	
000D	Output Lower Limit	H'00000000 to H'000003E8	
000E	Heater Burnout Threshold	H'00000001 to H'00000064	---
000F	Heater Characteristic Resistance for Phase Control	H'00000000 to H'000003E7	The data range is ten times the actual values.
0010	Heater Characteristic Resistance for Optimum Cycle Control	H'00000000 to H'000003E7	
0011	Heater Burnout Detection Lower Limit	H'00000000 to H'000003E8	

**Note** Use address 0000 to set the communications main setting (input variable) from the PLC.

**Variable Type C3/83**

Address	Data	Data range	Notation
0000	Communications Data Length	H'00000000 or H'00000001	0: 7 bits 1: 8 bits
0001	Communications Stop Bits	H'00000000 or H'00000001	0: 1 bit 1: 2 bits
0002	Communications Parity	H'00000000 to H'00000002	0: None 1: Even 2: Odd
0003	Send Wait Time	H'00000000 to H'00000063	0 to 99 ms
0004	Communications Timeout Time	H'00000000 to H'000003E7	0: Communications timeout function disabled 0 to 999 s
0005	Communications Unit Number	H'00000000 to H'00000063	0 to 99
0006	Communications Baud Rate	H'00000000 to H'00000003	0: 9.6 k bit/s 1: 19.2 k bit/s 2: 38.4 k bit/s 3: 57.6 k bit/s

Address	Data	Data range	Notation	
0007	Communications Main Setting Number	H'00000000 to H'00000008	0: Automatic assignment 1: CH1 control output (heating) (See note 1.) 2: CH2 control output (heating) 3: CH3 control output (heating) 4: CH4 control output (heating) 5: CH1 control output (cooling) 6: CH2 control output (cooling) 7: CH3 control output (cooling) 8: CH4 control output (cooling)	
0008	External Duty Input Enable/Disable	H'00000000 to H'00000001	0: Disable 1: Enable	
0009	Output Mode Selection	H'00000000 to H'00000003	0: Proportional to phase angle (same as G3PX) 1: Proportional to square voltage 2: Proportional to voltage 3: Constant current	
000A	Input Digital Filter Time Constant	H'00000000 to H'000003E8	0.0 to 100 ms (See note 2.)	
000B	Input Signal Type	H'00000000 to H'00000001	0: Linear input 1: Voltage ON/OFF input	
000C	Main Setting Automatic Input Selection	H'00000000 to H'00000001	0: 4 to 20 mA or 1 to 5 VDC 1: Communications	
000D	Main Setting Manual Input Selection	H'00000000 to H'00000001	0: External variable resistor input 1: Key input	
000E	Control Method Default	H'00000000 to H'00000001	0: Phase control 1: Optimum cycle control	
000F	Main Setting Automatic/Manual Default	H'00000000 to H'00000001	0: Automatic 1: Manual	
0010	Number of Alarms for Heater Burnout Detection	H'00000000 to H'000003E7	0 to 999 alarms	
0011	Load Current Upper Limit	H'00000000 to H'00000294	0.0 to 66.0 A (See note 2.) * 0: Function disabled.	
0012	Event Input Assignment	H'00000000 to H'00000002	0: No assignment 1: Control method selection 2: Main setting automatic/manual selection	
0013	Alarm Output Open in Alarm	H'00000000 to H'00000001	0: Close in alarm (NO contact operation) 1: Open in alarm (NC contact operation)	
0014	Heater Burnout Alarm Operation	H'00000000 to H'00000002	0: Disable 1: Alarm level 1 (fatal error) 2: Alarm level 2 (nonfatal error)	
0015	Total Run Time Exceeded Alarm Operation	H'00000000 to H'00000002	0: Disable 1: Alarm level 1 (fatal error) 2: Alarm level 2 (nonfatal error)	
0016	Total Run Time Alarm Set Value	H'00000000 to H'000003E7	0.0 to 99.9 kh (See note 2.) 0.0: Function disabled	
0017	External Input Range Alarm Operation	H'00000000 to H'00000002	0: Disable 1: Alarm level 1 (fatal error) 2: Alarm level 2 (nonfatal error)	
0018	External Duty Input Alarm Operation	H'00000000 to H'00000002	0: Disable 1: Alarm level 1 (fatal error) 2: Alarm level 2 (nonfatal error)	
On or after Ver 1.1	0019	SSR short circuit detection enabled	H'00000000 to H'00000001	0: Disabled 1: Enabled
	001A	SSR open failure detection	H'00000000 to H'00000001	0: Disabled 1: Enabled
	001B	CT failure detection	H'00000000 to H'00000001	0: Disabled 1: Enabled

\* Ten times the actual values.

- Note**
- (1) Specify 1 for a connection with the PLC.
  - (2) Set ten times the actual value.

## 6-5 Variable Area Write

This command changes set values.

### Command

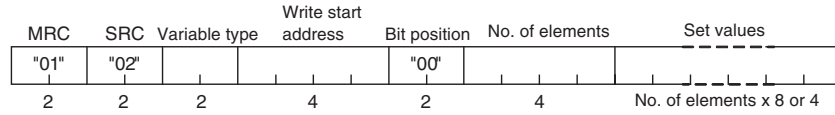

**Note** In the G3PW, the bit position is not used. Set it to "00".

### Response

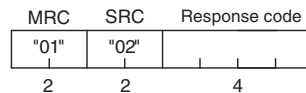

■ **Variable Type and Write Start Address**

Refer to the 6-4 Services and Addresses.

■ **Number of Elements**

Specify the number of elements for which the set value is to be changed. Up to 8 elements can be specified.

■ **Response Code**

Response code	Error name	Cause
"1002"	Command length too short	The command is too short.
"1101"	Area type error	The specified variable type does not exist.
"1003"	Number of elements/Number of data do not agree	The specified number of elements does not agree with the actual number of data elements.
"1100"	Parameter error	The bit position specification is not "00". A set value is outside of the setting range.
"2203"	Operation error	An error occurred in nonvolatile memory.
"0000"	Normal end	Processing was completed normally.

**Example:** The following command changes the manipulated variable for channel 1 to 50% (set value: 8 digits).

Command: [STX]010000**102C10000000001000001F4**[ETX][BCC]

Response: [STX]010000**1020000**[ETX][BCC]

**Example:** The following command changes the manipulated variable for channel 1 to 50% (set value: 4 digits).

Command: [STX]010000**10281000000000101F4**[ETX][BCC]

Response: [STX]010000**1020000**[ETX][BCC]

## 6-6 Variable Area Read

This command reads set values.

### Command

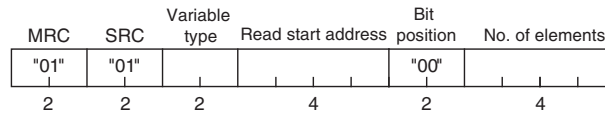

**Note** In the G3PW, the bit position is not used. Set it to "00".

### Response

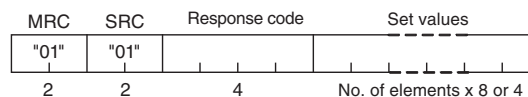

#### ■ Variable Type and Read Start Address

Refer to the 6-4 *Services and Addresses*.

#### ■ Number of Elements

Specify the number of elements for which the set value is to be read. Up to 8 elements can be specified.

#### ■ Response Code

Response code	Error name	Cause
"1001"	Command length too long	The command is too long.
"1002"	Command length too short	The command is too short.
"1101"	Area type error	The specified variable type does not exist.
"110B"	Response length too long	The number of elements is larger than the maximum number allowed.
"1100"	Parameter error	The bit position specification is not "00".
"2203"	Operation error	An error occurred in nonvolatile memory.
"0000"	Normal end	Processing was completed normally.

**Example:** The following command reads current (set value: 8 digits).

Command: [STX]010000101CE0004000001[ETX][BCC]

Response: [STX]0100000101000000000000[ETX][BCC]

**Example:** The following command reads current (set value: 4 digits).

Command: [STX]0100001018E0004000001[ETX][BCC]

Response: [STX]010000010100000000[ETX][BCC]

Status

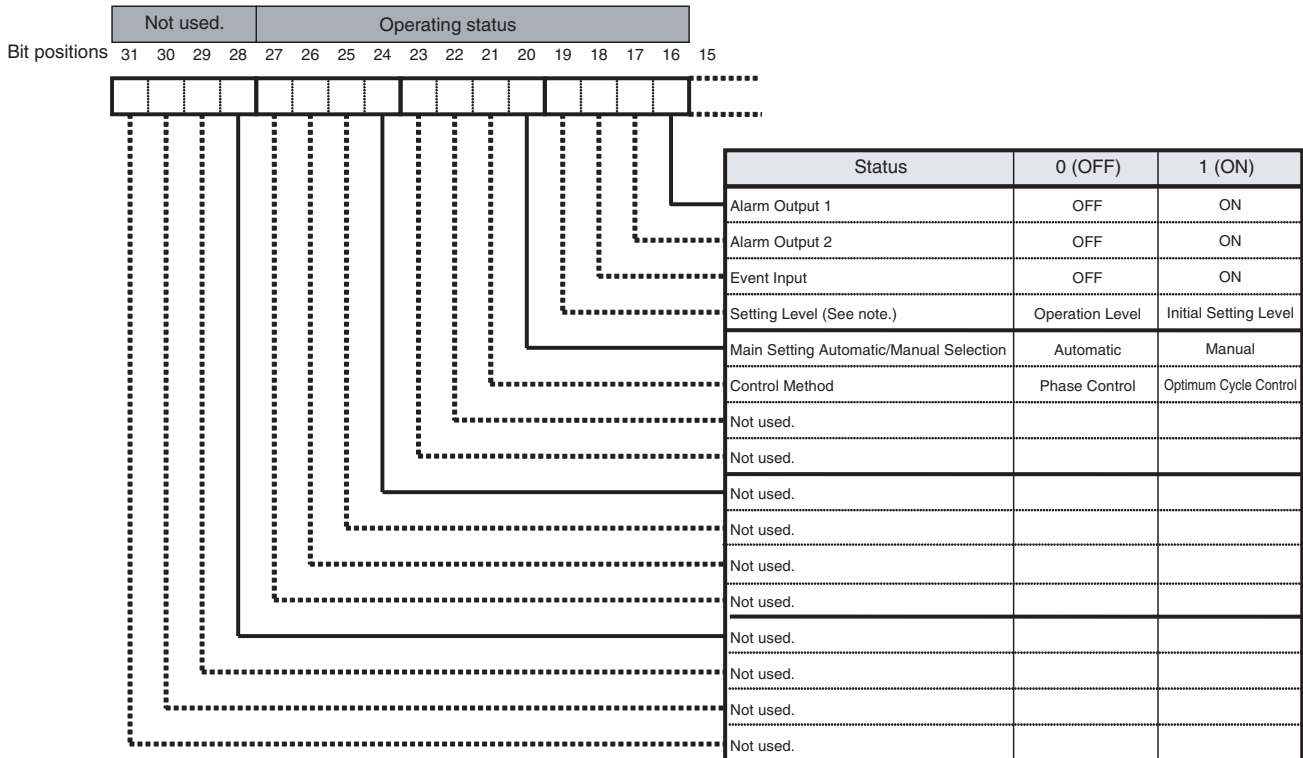
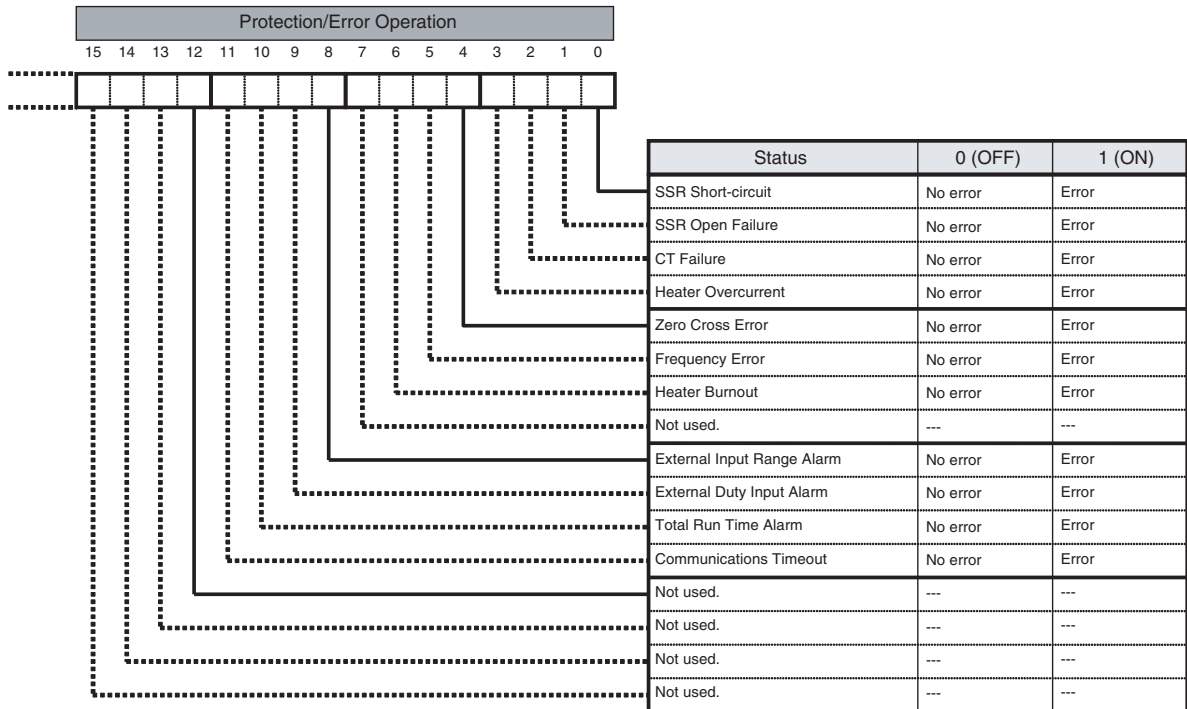



■ For model EJ1

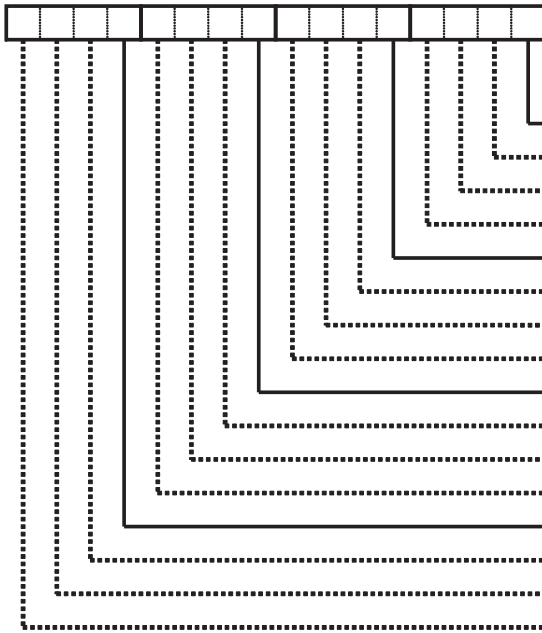
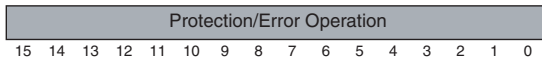

Status	0 (OFF)	1 (ON)
Heater Burnout	OFF	ON
SSR Short-circuit or SSR Open Failure	OFF	ON
Heater Overcurrent	OFF	ON
Not used.	---	---
Zero Cross Error or Frequency Error	OFF	ON
Communications Timeout	OFF	ON
Not used.	---	---
Not used.	---	---
Not used.	---	---
Not used.	---	---
Not used.	---	---
Not used.	---	---
Not used.	---	---
Not used.	---	---
Not used.	---	---
Not used.	---	---
Not used.	---	---
Not used.	---	---

## 6-7 Operation Command

This command is used to start and stop operation, save the manipulated variable, execute a software reset, or initialize settings.

### Command

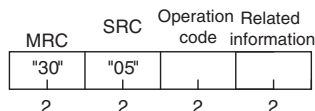

### Response

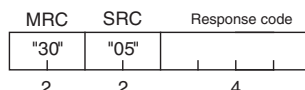

### Operation Codes and Related Information

Operation code	Operation	Related information
"06"	Software Reset	Always 00.
"07"	Setting Level Change (See note 1.)	00: Display level other than Initial Setting Level 01: Display Initial Setting Level
"09"	Main Setting Automatic/Manual Selection (See note 2.)	00: Automatic 01: Manual
"0A"	Control Method Selection (See note 3.)	00: Phase control 01: Optimum cycle control
"0B"	Parameter Initialization (See note 4.)	Always 00.
"0C"	Error Reset	Always 00.
"0D"	Total Time Initialization (See note 4.)	Always 00.
"0F"	Pause (See note 5.)	Always 00.

- Note**
- (1) Execute a software reset to go from Initial Setting Level to Monitor Level.
  - (2) To use operation code 09, switching between automatic and manual for the main setting must not be assigned to an event input (i.e., [P11] must not be set to 2). Always set [P11] to 0 before using this operation code. An operation error will occur if [P11] is set to 0.
  - (3) To use operation code 0A, switching the control method not be assigned to an event input (i.e., [P11] must not be set to 1). Always set [P11] to 0 before using this operation code. An operation error will occur if [P11] is set to 0.
  - (4) Parameters and the total time can be initialized only in Initial Setting Level.
  - (5) Execute an error reset to release the pause.

### Response Codes

Response code	Error name	Cause
"1001"	Command length too long	The command is too long.
"1002"	Command length too short	The command is too short.
"1100"	Parameter error	The operation code or related information is not correct.
"2203"	Operation error	An error occurred in nonvolatile memory.
"0000"	Normal end	Processing was completed normally.

**Example:** The following command executes a software reset.

Command: [STX]0100030050600[ETX][BCC]

Response: None

## 6-8 Controller Attribute Read

This command reads the model number of the Controller and the communications buffer size.

### Command

MRC	SRC
"05"	"03"
2	2

### Response

MRC	SRC	Response code	Model number	Buffer size
"05"	"03"		"G3PW- "	"0071"
2	2	4	10	4

### Model Number

G	3	P	W	-	①	②	③	④	⑤
---	---	---	---	---	---	---	---	---	---

Number	Code	Meaning
①	"A"	Constant Current
②	"1"	Always 1.
③	"0"	20 A
	"1"	30 A
	"2"	45 A
	"3"	60 A
④	"0"	Always 0.
⑤	"3"	Always 3.

### Buffer Size

The buffer size is 113 bytes (=071 hex).

### Response Code

Response code	Error name	Cause
"1001"	Command length too long	The command is too long.
"0000"	Normal end	Processing was completed normally.

**Example:** The following response would be returned for a model with a 45-A rating.

Command: [STX]010000503[ETX][BCC]

Response: [STX]01000005030000G3PW-A12030071[ETX][BCC]

## 6-9 Controller Status Read

This service reads the operating status and error status.

### Command

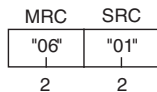

### Response

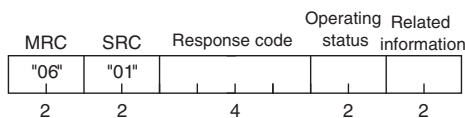

### Operating Status

Operating status	Meaning
"00"	Operating (when operating status is read in Monitor Level or Adjustment Level and an error has not occurred)
"01"	Stopped (other conditions)

### Related Information

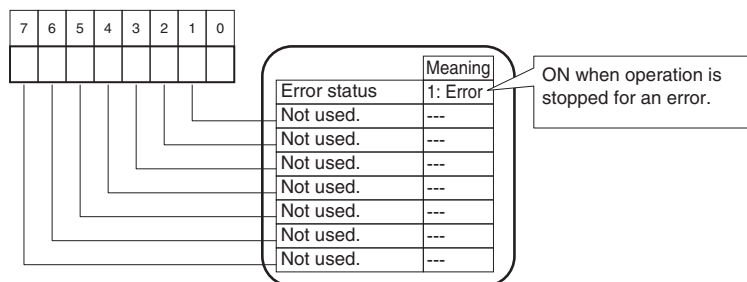

### Response Code

Response code	Error name	Cause
"1001"	Command length too long	The command is too long.
"0000"	Normal end	Processing was completed normally.

### Example:

Command: [STX]010000601[ETX][BCC]

Response: [STX]010000060100000000[ETX][BCC]

## 6-10 Echo-back Test

This command performs an echo-back test.

### Command

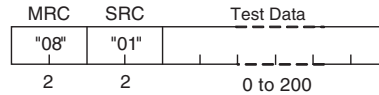

### Response

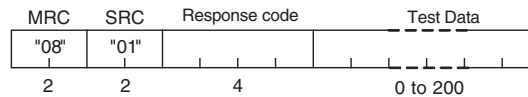

#### 1. Test Data

The test data can contain up to 200 (00C8H) bytes.

Set the test data within the following ranges according to the communications data length setting.

Data length	Test data
7 bits	ASCII 20H to 7EH
8 bits	ASCII 20H to 7EH or A1H to FEH

#### 2. Response Codes

Response code	Error name	Cause
"1001"	Command length too long	The command is too long.
"0000"	Normal end	Processing was completed normally.

#### Example:

Command: [STX]010000**0801123**[ETX][BCC]

Response: [STX]010000**08010000123**[ETX][BCC]

## 6-11 ASCII Table

Leftmost digit Rightmost digit	0	1	2	3	4	5	6	7
0	NUL	DLE	SPACE	0	@	P	`	p
1	SOH	DC1	!	1	A	Q	a	q
2	STX	DC2	“	2	B	R	b	r
3	ETX	DC3	#	3	C	S	c	s
4	EOT	DC4	\$	4	D	T	d	t
5	ENQ	NAK	%	5	E	U	e	u
6	ACK	SYN	&	6	F	V	f	v
7	BEL	ETB	'	7	G	W	g	w
8	BS	CAN	(	8	H	X	h	x
9	HT	EM	)	9	I	Y	i	y
A	LF	SUB	*	:	J	Z	j	z
B	VT	ESC	+	;	K	[	k	{
C	FF	FS	,	<	L	¥	l	
D	CR	GS	-	=	M	]	m	}
E	SO	RS	.	>	N	^	n	~
F	SI	US	/	?	O	_	o	DEL

# SECTION 7

## Error Processing

This section provides troubleshooting information.

7-1	Checking Possible Errors . . . . .	94
7-2	Error Displays . . . . .	95
7-3	Detailed Descriptions of Errors. . . . .	97

# 7-1 Checking Possible Errors

## Troubleshooting

### Check Flow When There Is No Output

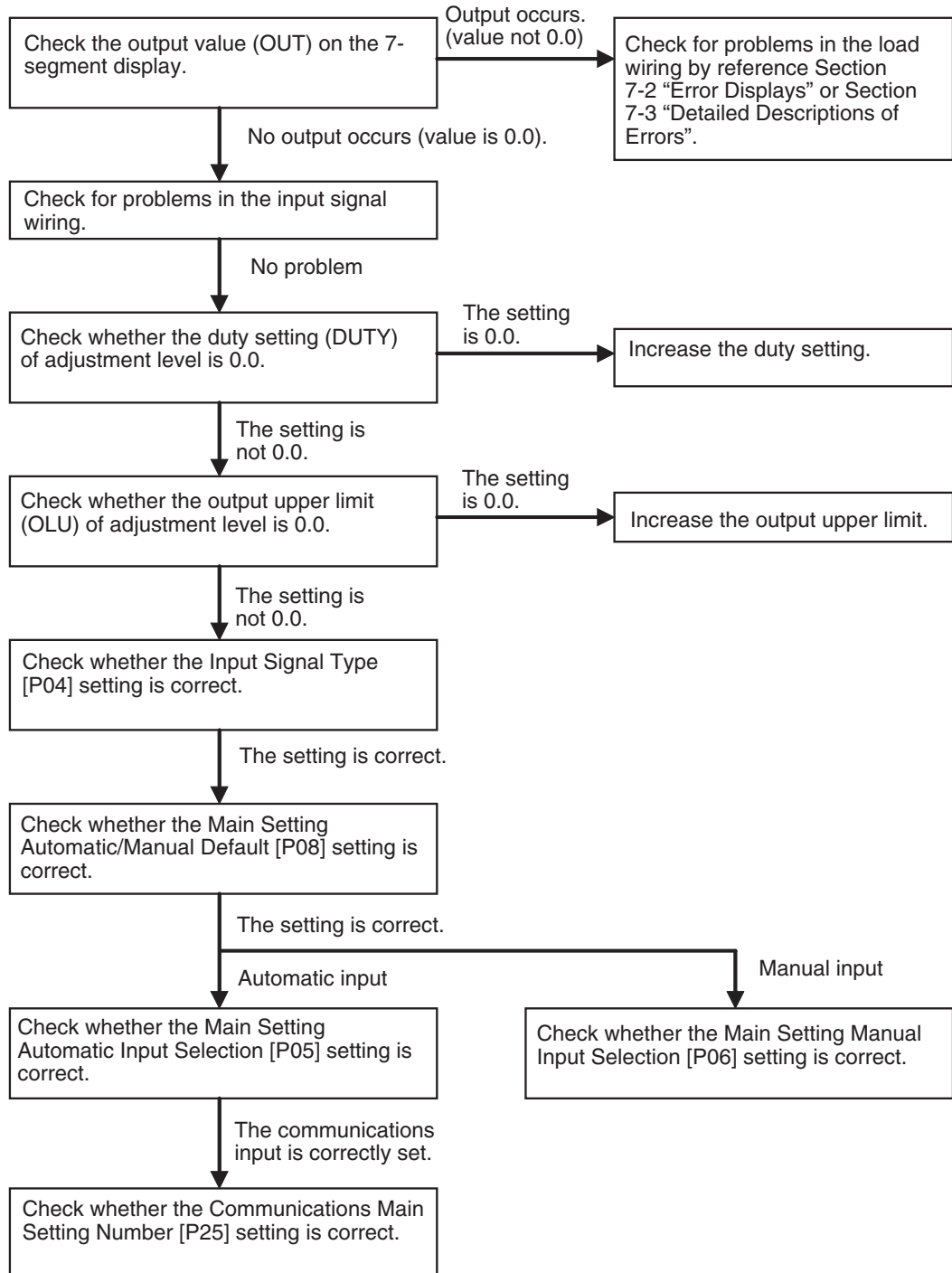

\* In Section 4-6, "Setting Parameter in the Initial Setting Level" will be referred, and confirm correct setting.



## 7-2 Error Displays

### Errors That Stop the Output (Alarm Level 1)

Display	Error name	Probable cause	Countermeasures
E01	RAM Error	Error in the internal memory or nonvolatile memory	Turn ON the power again. If this does not remove the error, the operation of the Power Controller must be checked by OMRON.
E02	EEPROM Checksum Error (Calibration Value Error/Illegal Identification Code)		
E03	EEPROM Checksum Error (Set Value)	Error in the set values in the nonvolatile memory	Move to the initial setting level and initialize the set values. If this does not remove the error, the operation of the Power Controller must be checked by OMRON.
E04	EEPROM Checksum Error (Total Run Time)	Error in the total run time in the nonvolatile memory	Move to the initial setting level and initialize the total run time. If this does not remove the error, the operation of the Power Controller must be checked by OMRON.
E10	SSR Short-Circuit	The SSR is short-circuited or the heater is totally burned out.	<ul style="list-style-type: none"> <li>• Check that the heater is not burned out. Turn on the power again or reset abnormal situation using alarm reset function (*). If this does not remove the error, the operation of the Power Controller must be checked by OMRON.</li> <li>• This error will occur if the power supply and load circuits are not wired correctly. See <i>3-3-1 Wiring the Power Supply and Load Circuits</i> on page 26 and <i>3-3-5 Wiring an External Noise Filter</i> on page 32.</li> </ul>
E11	SSR Open Failure	<ul style="list-style-type: none"> <li>• SSR open failure</li> <li>• The heater is connected to terminal L1 on the load terminal block.</li> <li>• Terminal L1 on the load terminal block is disconnected (blown fuse, line break, etc.)</li> </ul>	<p>Make sure that the heater is connected to terminal T1 on the load terminal block, and that there are no problems with the L1 terminal connection. Turn on the power again or clear the error using the using alarm reset function (*).</p> <p>If the error still occurs, operation must be checked by OMRON.</p>
E12	CT Failure (only constant current model)	The built-in CT Unit has failed or the heater elements are all burned out.	Check that the heater is not burned out. Turn on the power again or reset abnormal situation using alarm reset function (*). If this does not remove the error, the operation of the Power Controller must be checked by OMRON.
E20	Heater Overcurrent Error (only constant current model)	An overcurrent was detected.	An overcurrent is flowing to the heater. Check the load and use the alarm reset (see note) to clear the error.
E30	Zero Cross Error	A zero cross error or frequency error was detected.	Check whether the load power supply voltage and the frequency are within the specified ranges.
E31	Frequency Error	Frequently fluctuate plus or minus 3 Hz.	<p>Check whether noise is occurring in the load power supply line or in the surroundings.</p> <p>Use the alarm reset (see note) to clear the error.</p>
E40	Heater Burnout Alarm	A heater burnout was detected.	Refer to <i>5-9 Heater Burnout Detection (Constant-current Models Only)</i> , check for burnout, and check the set values. Use the alarm reset (see note) to clear the error.
E50	External Input Range Alarm	A disconnected line was detected for the 4 to 20-mA or 1 to 5-V input signal input or external variable resistor.	<p>A disconnected line was detected for the 4 to 20-mA or 1 to 5-V input signal input or external variable resistor. Check the location of the disconnection.</p> <p>If the 4 to 20-mA or 1 to 5-V input signal input and external variable resistor are not being used, refer to the auxiliary input-related parameters and make the setting.</p> <p>Use the alarm reset (see note) to clear the error.</p>

Display	Error name	Probable cause	Countermeasures
E51	External Duty Input Alarm	External duty input disconnection	A disconnected line was detected for the external duty variable resistor. Check the location of the disconnection. If the external duty variable resistor is not being used, set the External Duty Input Enable/Disable parameter [P01] to <i>Disable</i> . Use the alarm reset (see note) to clear the error.
E60	Total Run Time Threshold Exceeded Alarm	The total run time exceeded the set value of the Total Run Time Alarm Set Value parameter.	The internal total run time has exceeded the set value of the Total Run Time Alarm Set Value parameter. Increase the set value or initialize the total run time. Use the alarm reset (see note) to clear the error.
E70	Communications Timeout Alarm	A communications timeout occurred.	Check whether the communications lines are disconnected. Check whether the host device is operating correctly. The error is cleared by correctly writing the main setting from the host.

**Note** To reset the alarm, press the ENT/RST Key, or communication reset command (only FLK type), turn ON the RESET input. (On or after Ver 1.1)

### Errors for Which the Output Continues (Alarm Level 2)

Display	Error name	Probable cause	Countermeasures
E40	Heater Burnout Alarm (when assigned to alarm level 2)	The heater resistance rate of change exceeded value set for the Heater Burnout Threshold (HBR) parameter for more cycles than the value set for the Number of Alarms for Heater Burnout Detection parameter [P09].	Reset the error by using the ENT/RST Key, execute a reset input from the RESET terminal, or execute a reset command via communications. If more than one error has occurred consecutively for the output, all of the errors will be cleared for one reset operation.
E50	External Input Range Alarm (when assigned to alarm level 2)	A 4 to 20-mA or 1 to 5-V input signal was out of the input range.	
E51	External Duty Input Alarm (when assigned to alarm level 2)	The external duty variable resistor is disconnected.	
E60	Total Run Time Alarm (when assigned to alarm level 2)	The total run time exceeded the set value for the Total Run Time Threshold parameter [P17].	

**Note** To reset the alarm, press the ENT/RST Key, or communication reset command (only FLK type), turn ON the RESET input.

## 7-3 Detailed Descriptions of Errors

### **E01: RAM Error**

An error occurred in the internal memory. Consult with your OMRON representative.

### **E02: EEPROM Checksum Error**

An error occurred in the system area in EEPROM. The operation of the Power Controller must be checked by OMRON. Consult with your OMRON representative.

### **E03: EEPROM Checksum Error (Setting Error)**

An error occurred in the user-set parameter area in EEPROM. Initialize the parameters set in the initial setting level and the adjustment level, and then turn the power OFF and back ON. After restarting, set the correct values for the parameters in the initial setting level and the adjustment level.

**Note** Until the correct parameter settings are made, unintended outputs may occur. While initializing the user-set parameters and making the settings again, lower the input value and take sufficient precautions.

#### Recovery Procedure

- 1,2,3...**
1. Move to the initial setting level.  
Press the LVL Key for at least 2 s. The Initialize Set Values parameter [P28] in the initial setting level will be displayed.
  2. Enter the Initialize Set Values Menu.  
Press the ENT/RST Key.
  3. Select the Initialize Set Values Menu.  
Press the UP Key once to display  $\bar{\sim}\bar{\sim}$  (INI) on the display.
  4. Initialize the set values.  
Press the ENT/RST Key to initialize the set values. After 0.5 s, the display will automatically return to the Initialize Set Values parameter [P28].
  5. Turn the Power Controller power OFF and then back ON.  
In the initial setting level, press the LVL Key for at least 2 s. The Power Controller will be reset and restarted.

### **E04: EEPROM Checksum Error (Total Run Time Error)**

An error occurred in the total run time area in EEPROM. A total run time checksum error occurred when reading EEPROM at startup. Reset the total run time to 0 and then turn the power OFF and back ON. The total run time prior to the initialization will be lost.

#### Recovery Procedure

- 1,2,3...**
1. Move to the initial setting level.  
Press the LVL Key for at least 2 s. The Reset Total Run Time parameter [P27] in the initial setting level will be displayed.
  2. Enter the Reset Total Run Time Menu.  
Press the ENT/RST Key.
  3. Select the Initialization Menu.  
Press the UP Key once to display  $\bar{\sim}\bar{\sim}$  (INI) on the display.
  4. Reset the total run time.  
Press the ENT/RST Key to initialize the total run time. After 0.5 s, the display will automatically return to the Reset Total Run Time Menu [P27].
  5. Turn the Power Controller power OFF and then back ON.  
In the initial setting level, press the LVL Key for at least 2 s. The Power Controller will be reset and restarted.

**E10: SSR Short-Circuit**

- An SSR short-circuit error occurs when either an SSR short-circuit failure occurs or when 0 (None) is set for the Heater Burnout Alarm Operation parameter [P14] and all the heaters have burned out.
- With a standard model of the G3PW Power Controller, this error will occur if a heater burnout occurs when only one heater is being used.
- This error will occur if the power supply and load circuits are not wired correctly. Check the connections again.
- An SSR short-circuit error will occur if the power is turned ON with no load connected. Parameter settings will still be enabled. At error condition, parameter can be changed.
- Turn OFF the power to the Power Controller and to the heater and check for heater burnout. If the heater is burned out, replace it.

If heater burnout cannot be easily confirmed, the following procedure can be used to isolate SSR short-circuiting and heater burnout.

\* It is possible to be deauthorized. (On or after Ver 1.1)

**Isolating SSR Short-circuiting and Heater Burnout**

With a Constant-current Model, it is possible to distinguish between SSR short-circuit and heater burnout alarms by using the following procedure.

- 1,2,3...**
1. Set the reference value to 0%.
  2. Restart the G3PW by turning the power OFF and back ON or by using the reset operation.
  3. Monitor the load current in the monitor level once the G3PW restarts operation. If a large load current is flowing, there is an SSR short-circuit. If a large load current is not flowing, there is a heater burnout.

 **Caution** If there is an SSR short-circuit, a load current equivalent to a 100% output will flow. Before turning ON the power again, confirm that your equipment will not be affected.

**Using a Constant-current Model**

With a Constant-current Model, it is possible to distinguish between E10 (SSR short-circuit) and E40 (heater burnout alarm) errors by assigning 1 (Alarm level 1) or 2 (Alarm level 2) to the Heater Burnout Alarm Operation parameter [P14].

**E11: SSR Open Failure**

This error occurs in the following cases.

- SSR open failure.
- The heater is connected to terminal L1 on the load terminal block, and the output phase angle is 28% or higher.
- Check if a heater disconnected (blown fuse, line break, etc.) from terminal L1 on the load terminal block is connected to terminal T1 on the load terminal block, or if there are other problems with the L1 terminal connection. Turn on the power again or restart the G3PW using the reset function.

If the error still occurs after restarting, an SSR open failure has occurred. Operation must be checked by OMRON.

\* This error can also be disabled. (Ver. 1.1 and later)

**E12: CT Failure**

A CT failure error occurs when either the built-in CT has failed or the output mode is set to constant current mode and all of the heaters connected to the Power Controller have burned out.

Turn OFF the power to the Power Controller and to the heaters, and check for heater burnout. If there is no heater burnout, then it means that the CT has failed. In that case, the operation of the Power Controller must be checked by OMRON. Consult with your OMRON representative.

If heater burnout cannot be easily confirmed, the following procedure can be used to distinguish between CT failure and heater burnout. First check whether the problem continues when the output mode is change, and then perform this procedure.

\* It is possible to be deauthorized. (On or after Ver 1.1)

**Procedure for Distinguishing CT Failure and Heater Burnout**

**1,2,3...**

1. Set the input value to 0%
2. Set the output mode to a mode other than constant current.  
Press the LVL Key for at least 2 s to enter the initial setting mode. Select 0 (Proportional to phase angle) in the Output Mode Selection parameter [P02].
3. If an E10 (SSR short-circuit) error occurs after restarting, there is a high probability of heater burnout.
4. Return the output mode to constant current mode.

**E20: Heater Overcurrent Error**

A heater overcurrent error occurs when the load current exceeds 120% of the rated current for 250 cycles (approx. 5 s). Reduce the input value and then perform a reset operation (using the ENT/RST Key, a reset input, or a reset command via communications).

If the load current becomes too large, consider using the duty setting or output limit function.

**E30: Zero Cross Error**

A zero cross error occurs when there is a failure to detect the power supply zero cross point. Check whether the power supply waveforms are irregular, and perform a reset operation (using the ENT/RST Key, a reset input, or a reset command via communications).

**E31: Frequency Error**

A frequency error occurs when the power supply frequency is outside of the range of 50/60 Hz  $\pm$  3 Hz (47 to 63 Hz) and the frequency fluctuates at a rate of 3 Hz/s or greater.

Confirm that the power supply frequency is stable, and then perform a reset operation (using the ENT/RST Key, a reset input, or a reset command via communications).

**E40: Heater Burnout Alarm**

When a heater burnout alarm error (E40) occurs, use the following procedure to remove the problem.

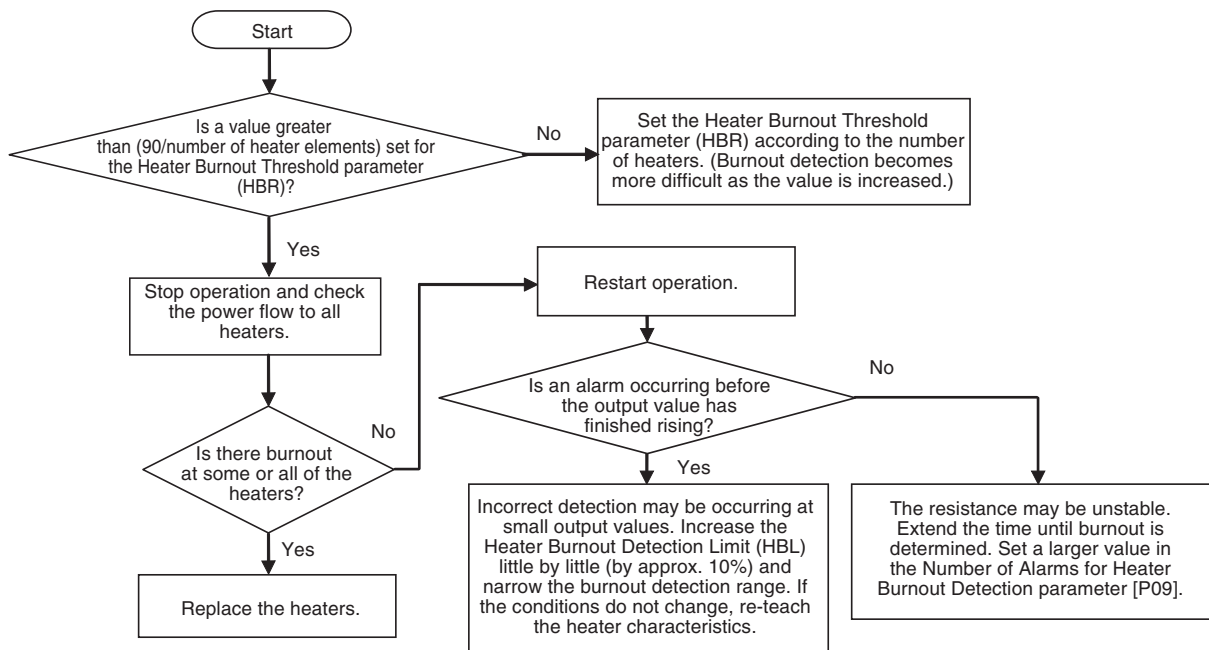

### **E50: External Input Range Alarm**

An external input range alarm occurs when a 4 to 20-mA or 1 to 5-V input signal or variable resistor main setting input is outside of the input range. Check whether the input signal range is correct and whether the external resistor wiring is disconnected. Then perform a reset operation (using the ENT/RST Key, a reset input, or a reset command via communications).

### **E51: External Duty Input Alarm**

An external duty input alarm occurs when an external variable duty setting input is outside of the input range. Check whether the external resistor wiring is disconnected. Then perform a reset operation (using the ENT/RST Key, a reset input, or a reset command via communications).

### **E60: Total Run Time Alarm**

A total run time alarm occurs when the total run time exceeds the time set in the Total Run Time Threshold parameter [P17]. Either increase the setting for the Total Run Time Threshold parameter [P17] in the initial setting level, or reset the total run time by setting the Reset Total Run Time parameter [P27] to 1. Then perform a reset operation (using the ENT/RST Key, a reset input, or a reset command via communications).

### **E70: Communications Timeout Alarm**

A communications timeout alarm occurs when communications with the host controller fail because the time set in the Communications Timeout Time parameter [P26] is exceeded. Check whether the host device is operating normally, and whether there is a burnout in the communications lines. The error status will be cleared by correctly writing the main setting from the host.

To not have communications timeouts detected, set the Communications Timeout Time parameter [P26] to 0.

# Appendix A

## Parameters Set in Initial Setting Level

Display	Name	Setting	State of parameter preserving during power off
P01	External Duty Input Enable/Disable	Enables or disables setting the duty using an external variable resistor. 0: Disable (Default) 1: Enable	Yes
P02	Output Mode Selection for Phase Control	Selects the output mode for phase control. 0: Proportional to phase angle (same as G3PX) (Default) 1: Proportional to square voltage 2: Proportional to voltage 3: Constant current (Constant-current Models only)	Yes
P03	Input Digital Filter Time Constant	Sets the software filter time constant in relation to the input command value when automatic input is set for the main setting. 0.0 to 100 ms (Default: 0.0)	Yes
P04	Input Signal Type	Sets the type of input signal from a temperature controller. 0: Linear input (Default) 1: Voltage ON/OFF input	Yes
P05	Main Setting Automatic Input Selection*1	Sets the input source when automatic input is set for the main setting. 0: 4 to 20 mA or 1 to 5 VDC (Default) 1: Communications	Yes
P06	Main Setting Manual Input Selection	Sets the input source for when manual input is set for the main setting. 0: External variable resistor input (Default) 1: Key input	Yes
P07	Control Method Default	Sets the control method to use after a reset. 0: Phase control (Default) 1: Optimum cycle control  <b>Note</b> If the Event Input Assignment parameter [P11] is set to 1 (control method selection), the control method selected with the event inputs will be used regardless of the setting of this parameter.	Yes
P08	Main Setting Automatic/Manual Default	Sets the main setting input mode to use after a reset. 0: Automatic (Default) 1: Manual  <b>Note</b> If the Event Input Assignment parameter [P11] is set to 2 (main setting automatic/manual selection), the control method selected with the event inputs will be used regardless of the setting of this parameter.	Yes
P09	Number of Alarms for Heater Burnout Detection*1	An alarm is output when an error status continues for more than the specified number of cycles. 0 to 999 (Default: 150)	Yes
P10	Load Current Upper Limit*1	Sets the upper limit for the current that can flow to the load. 0.0 to 66.0 0: This function stops when the parameter is set to 0. (Default)	Yes
P11	Event Input Assignment	Sets the event input application. 0: No assignment (Default) 1: Control method selection (phase control or optimum cycle control) 2: Main setting automatic/manual selection	Yes
P12	Alarm Output Open in Alarm	Sets the alarm output operation. 0: Close in alarm (NO contact operation) 1: Open in alarm (NC contact operation) (Default)	Yes

Display	Name	Setting	State of parameter preserving during power off
P 13	Alarm Output Test	Used to perform an alarm output test. 0: No test output (Default) 1: Test output on ALARM1 terminal 2: Test output on ALARM2 terminal 3: Test output on ALARM1 and ALARM2 terminals	No
P 14	Heater Burnout Alarm Operation*1	Sets the alarm level to use when a heater burnout alarm occurs. 0: Disable (Default) 1: Alarm level 1 (fatal error) 2: Alarm level 2 (nonfatal error)	Yes
P 15	Total Run Time Exceeded Alarm Operation	Sets the alarm level to use when the total run time exceeds the set value. 0: Disable (Default) 1: Alarm level 1 (fatal error) 2: Alarm level 2 (nonfatal error)	Yes
P 16	Total Run Time Alarm Set Value*1	An alarm is output when the total run time exceeds the set value. 0.0 to 99.9 kh 0.0: This function stops when the parameter is set to 0.0. (Default)	Yes
P 17	External Input Range Alarm Operation	Sets the alarm level when an external variable resistor disconnection occurs or when the 4 to 20-mA or 1 to 5-V input range is exceeded. 0: Disable (Default) 1: Alarm level 1 (fatal error) 2: Alarm level 2 (nonfatal error)	Yes
P 18	External Duty Input Alarm Operation	Sets the alarm level when an external duty variable resistor disconnection occurs or when the 4 to 20-mA or 1 to 5-V input range is exceeded. 0: Disable (Default) 1: Alarm level 1 (fatal error) 2: Alarm level 2 (nonfatal error)	Yes
P 19	Communications Unit Number*1	Sets the Communications unit number for CompoWay/F. 0 to 99 (Default: 1)	Yes
P 20	Communications Baud Rate*1	Sets the baud rate for CompoWay/F. 9.6: 9.6 k bit/s 19.2: 19.2 k bit/s 38.4: 38.4 k bit/s 57.6: 57.6 k bit/s (Default)	Yes
P 21	Communications Data Length*1	Sets the data length for communications. 7: 7 bits (Default) 8: 8 bits	Yes
P 22	Communications Stop Bits*1	Sets the number of stop bits for communications. 1: 1 bit 2: 2 bits (Default)	Yes
P 23	Communications Parity*1	Sets the parity for communications. none: None Even: Even (Default) odd: Odd	Yes
P 24	Send Wait Time*1	Sets the send wait time. 0 to 99 ms (Default: 1)	Yes



Display	Name	Setting	State of parameter preserving during power off
P25	Communications Main Setting Number*1	<p>Sets the MV input channel.</p> <ul style="list-style-type: none"> <li>• Connection to an OMRON EJ1 Modular Temperature Controller <ul style="list-style-type: none"> <li>0: Automatic assignment (recommended) (Default)</li> <li>1: CH1 control output (heating)      5: CH1 control output (cooling)</li> <li>2: CH2 control output (heating)      6: CH2 control output (cooling)</li> <li>3: CH3 control output (heating)      7: CH3 control output (cooling)</li> <li>4: CH4 control output (heating)      8: CH4 control output (cooling)</li> </ul> </li> <li>• Connection to an OMRON PLC <ul style="list-style-type: none"> <li>1: CH1</li> </ul> </li> </ul>	Yes
P26	Communications Timeout Time*1	<p>0 to 999 s (Default: 10)</p> <p>0: Communications timeout function disabled</p>	Yes
P27	Reset Total Run Time	<p>Used to reset the total run time.</p> <p>0: Do not reset. (Default)</p> <p>1: Initialize.</p>	No
P28	Initialize Set Values	<p>Used to initialize parameter settings.</p> <p>0: Do not initialize. (Default)</p> <p>1: Initialize.</p>	No
P29	SSR short circuit detection (On or after Ver 1.1)	<p>Set the alarm operation in case SSR short circuit or all heater burnout</p> <p>0: Disabled</p> <p>1: Enabled</p>	Yes
P30	SSR open failure detection (On or after Ver 1.1)	<p>Set the alarm operation in case SSR open failure or incorrect wiring of load</p> <p>0: Disabled</p> <p>1: Enabled</p>	Yes
P31	CT failure detection (On or after Ver 1.1 & only FLK Type)	<p>Set the alarm operation in case CT failure or all heater burnout</p> <p>0: Disabled</p> <p>1: Enabled</p>	Yes

\*1 Constant-current Models only.



## Appendix B

### Parameter Settings in the Adjustment Level

Display	Name	Description	State of parameter preserving during power off
INP (INP)	Key Input Main Setting	Sets the input value. 0.0% to 100% (Default: 0.0)	No
DTY (DTY)	Internal Duty Setting	Sets the proportion of the input value to the output value as a duty. 0.0% to 100% (Default: 100)	Yes
BUP (BUP)	Base-Up Value	Sets the amount to increase the output value so that the output value does not go to 0% even when the input value is 0%. 0.0% to 100% (Default: 0.0)	Yes
SUP (SUP)	Soft-start Up Time	Sets the time (from 0% to 100%) for increasing the output value gradually even when the input value increases suddenly. 0.0 to 99.9 s (Default: 0.5)	Yes
SDN (SDN)	Soft-start Down Time	Sets the time (from 100% to 0%) for decreasing the output value gradually even when the input value decreases suddenly. 0.0 to 99.9 s (Default: 0.0)	Yes
OLU (OLU)	Output Upper Limit	Sets the output upper limit. 0.0% to 100% (Default: 100.0) (If the output upper limit is set lower than the output lower limit, then the output upper limit will be treated as the output lower limit.)	Yes
OLL (OLL)	Output Lower Limit	Sets the output lower limit. 0.0% to 100% (Default: 0.0) (If the output lower limit is set higher than the output upper limit, then the output lower limit will be treated as the output upper limit.)	Yes
HBR (HBR)	Heater Burnout Threshold*1	Sets the criteria for the heater burnout alarm output. 1% to 100% (Default: 100)	Yes
TYP (TYP)	Control Method	Sets the control method. 0: Phase control (Default) 1: Optimum cycle control	No
A-m (A-m)	Main Setting Automatic/Manual	Sets automatic or manual operation for the main setting. 0: Automatic (Default) 1: Manual	No
TPC (TPC)	Teach Heater Characteristics for Phase Control*1	This parameter is displayed only when the control method is set to phase control. It is used to record heater characteristics (resistance, output value/output phase angle) for phase control.	No
HPR (HPR)	Heater Characteristic Resistance for Phase Control*1	This parameter is displayed only when the control method is set to phase control. It is used to check and correct the heater characteristic resistance set by teaching. 0.0 to 99.9 Ω (Default: 0.0)	Yes
TCC (TCC)	Teach Heater Characteristics for Optimum Cycle Control*1	This parameter is displayed only when the control method is set to optimum cycle control. It is used to record the heater characteristics (resistance) for optimum cycle control.	No
HCR (HCR)	Heater Characteristic Resistance for Optimum Cycle Control*1	This parameter is displayed only when the control method is set to optimum cycle control. It is used to check and correct the heater characteristic resistance set by teaching. 0.0 to 99.9 Ω (Default: 0.0)	Yes

Display	Name	Description	State of parameter preserving during power off
HbL (HBL)	Heater Burnout Detection Lower Limit*1	Sets the lower limit of the output value for judging heater burnout. 0.0% to 100% (Default: 0.0)	Yes
Pot (POT)	Total Run Time Monitor	Displays the total time power is turned ON to the Power Controller in units of 0.1 kh. 0.0 to 99.9 (Default: 0.0 (function disabled))	Yes

\*1 Constant-current Models only.

# Index

## Numerics

7-segment display, 14

## A

adjustment level, 42  
alarm level, 46  
alarm outputs, 5, 9, 30  
alarm reset, 51  
analog input, 8  
automatic operation input, 39  
automatic operation input wiring, 33

## B

base-up function, 3, 56

## C

checking  
  safety, *xii*  
cleaning, *xiii*  
command input and power supply terminal block, 14, 15, 27  
communications indicator, 14  
communications settings, 68  
communications specifications, 11, 68  
communications terminals, 31, 33  
communications timeout alarm, 100  
CompoWay/F, 5, 67, 68, 77  
  end codes, 78  
constant current, 8  
constant-current control, 37  
Constant-current Models, 3, 8  
continuous proportional output, 2  
control method, 8  
control methods, 36  
control proportional to phase angle, 37  
control proportional to square voltage, 37  
control proportional to voltage, 37  
control terminal block, 14, 29  
CT, 9  
CT failure, 99  
current detection, 9

current input terminals, 28, 33  
current limit, 3  
current transformer, 9  
current-temperature characteristic, 19  
CX-Thermo Support Software, 4

## D

dielectric strength, 10  
dimensions, 22  
duty setting, 2, 54  
  external variable resistor, 54  
  internal, 54

## E

EEPROM checksum error, 97  
EJ1, 2, 4, 10  
end nodes, 32  
error displays, 95  
errors  
  recovery, 97  
errors for which the output continues, 96  
errors that stop the output, 95  
event inputs, 3, 9, 50  
external contact input, 5  
external contact inputs, 50  
external duty input alarm, 100  
external duty setting, 5, 30  
external input range alarm, 100  
external main setting, 5, 30  
external setting  
  Variable Resistor, 6  
external setting inputs, 30

## F

FINS, 68  
FINS-mini, 79  
  command services, 80  
frequency error, 99  
Fuse Holder, 10, 27  
fuses, 10  
  fast-acting, 26, 27  
  time-delay, 26, 27

## **G**

grounding, 32

## **H**

heater burnout alarm, 9, 99  
heater burnout detection, 4, 61  
    multiple detections, 9  
    number of alarms for detection, 9  
    setting range, 9  
heater burnout detection accuracy, 9  
heater resistance, 4

## **I**

inductive noise  
    preventing, *X i i*  
initial setting level, 42, 43, 44  
initial settings, 2  
input signal, 5  
input signal type, 2  
input system, 39  
input value, 38  
input value-output value relation, 55  
inrush current resistance, 8, 20  
installation, *X i i*  
installation environment, *X i i*, 18  
installation in control panels, 24  
installation location, 18, 25  
insulation resistance, 10

## **K**

key input main setting, 39

## **L**

leakage current, 9, 10  
level indicators, 14  
load capacity, maximum, 8  
load current, 38  
load current limit, 8, 59  
load terminal block, 15, 26

## **M**

main setting  
    external variable resistor, 53  
main setting input, 39, 45  
manual operation  
    external variable resistor, 34  
    input, 39  
    input wiring, 34  
Modular Temperature Controller, 4  
monitor level, 38, 42  
monitored items, 38  
monitoring indicators, 14  
mounting hold dimensions, 23  
mounting screws, 24

## **N**

noise filter, 19, 32  
noise immunity  
    improving, 19  
nonmetal heaters, 3

## **O**

ON/OFF control, 2, 8, 36  
ON/OFF output, 2  
ON/OFF voltage input, 28  
operating humidity, humidity, 10  
operating temperature, ambient, 10, 18  
operation keys, 15  
operation level, 42  
operation selection input, 31  
optimum cycle control, 2, 8, 36  
output limit, 3, 57  
output mode, 2, 8  
output modes, 37  
output phase angle, 38  
output value, 38  
output value setting range, 8  
output voltage adjustable range, 8  
overcurrent detection, 10  
overcurrent error, 99

## **P**

parameter settings, 42  
  protective functions, 46  
phase control, 2, 5, 8, 36  
power supply frequency error, 10  
protective cover, 14  
pure metal heaters, 3

## **R**

RAM error, 97  
rated voltage, 8  
reset input, 31  
reset/event indicator, 14

## **S**

safety measures, *X i i*  
safety precautions, *v i i i*, *i x*  
screwless clamp terminal block, 6  
send wait time, 76  
serial communications, 10, 11  
Serial Communications Unit/Board, 74  
serial connection, 4  
side-by-side mounting, 19  
soft-start down function, 3, 8, 58  
soft-start up function, 3, 8, 58  
solid state relay, 2  
SSR, 2, 10, 98  
Standard Models, 3, 8  
storage, *X i i i*  
Super-rapid Fuse, 10, 27

## **T**

temperature controller, 2  
temperature sensor, 2  
terminal block with small slotted screws, 6  
terminating resistance, 32  
total run time, 3, 60  
total run time alarm, 100

## **V**

Variable Resistor, 6

voltage input terminals, 27, 33  
voltage ON/OFF input, 8

## **W**

weight, 10  
wiring, *X i i*, 26  
  load, 26  
  power supply, 26

## **Z**

zero cross error, 99

---

*Index*

---



## Revision History

A manual revision code appears as a suffix to the catalog number on the front cover of the manual.

Cat. No. Z280-E1-08

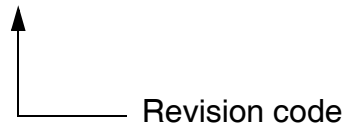

The following table outlines the changes made to the manual during each revision. Page numbers refer to the previous version.

Revision code	Date	Revised content
01	November 2008	Original production
02	---	Misdescription emendation/ supplemental explanation addition
03	May 2016	Version up from 1.0 to 1.1/ supplemental explanation addition
04	June 2017	Misdescription emendation/ supplemental explanation addition
05	January 2019	Misdescription emendation
06	December 2021	Misdescription emendation
07	September 2022	Added information on <i>Safety Precautions</i> .
08	June 2023	Misdescription emendation





## **OMRON Corporation Industrial Automation Company**

**Kyoto, JAPAN**

**Contact : [www.ia.omron.com](http://www.ia.omron.com)**

### ***Regional Headquarters***

#### **OMRON EUROPE B.V.**

Wegalaan 67-69, 2132 JD Hoofddorp  
The Netherlands

Tel: (31) 2356-81-300 Fax: (31) 2356-81-388

#### **OMRON ASIA PACIFIC PTE. LTD.**

438B Alexandra Road, #08-01/02 Alexandra  
Technopark, Singapore 119968

Tel: (65) 6835-3011 Fax: (65) 6835-3011

#### **OMRON ELECTRONICS LLC**

2895 Greenspoint Parkway, Suite 200  
Hoffman Estates, IL 60169 U.S.A.

Tel: (1) 847-843-7900 Fax: (1) 847-843-7787

#### **OMRON (CHINA) CO., LTD.**

Room 2211, Bank of China Tower,  
200 Yin Cheng Zhong Road,  
PuDong New Area, Shanghai, 200120, China

Tel: (86) 21-6023-0333 Fax: (86) 21-5037-2388

**Authorized Distributor:**

©OMRON Corporation 2008-2023 All Rights Reserved.  
In the interest of product improvement,  
specifications are subject to change without notice.

**Cat. No. Z280-E1-08** 0623