

Programmable Controller CS/CJ-series

Replacement Guide

From EtherNet/IP and Ethernet Units to Enhanced Security Units

CJ2H-CPU6□-EIP

CJ2H-CPU6□

CJ2M-CPU3□

CJ2M-CPU1□

C□1W-EIP21

C□1W-EIP21S

C□1W-ETN21

CS1D-ETN21D

Replace
Guide

NOTE

1. All rights reserved. No part of this publication may be reproduced, stored in a retrieval system, or transmitted, in any form, or by any means, mechanical, electronic, photocopying, recording, or otherwise, without the prior written permission of OMRON.
2. No patent liability is assumed with respect to the use of the information contained herein. Moreover, because OMRON is constantly striving to improve its high-quality products, the information contained in this manual is subject to change without notice.
3. Every precaution has been taken in the preparation of this manual. Nevertheless, OMRON assumes no responsibility for errors or omissions. Neither is any liability assumed for damages resulting from the use of the information contained in this publication.

Trademarks

- SYSMAC is a registered trademark for Programmable Controllers made by OMRON Corporation.
- CX-One is a registered trademark for Programming Software made by OMRON Corporation.
- Sysmac and SYSMAC are trademarks or registered trademarks of OMRON Corporation in Japan and other countries for OMRON factory automation products.
- Microsoft, Windows, Excel, Visual Basic, and Microsoft Edge are either registered trademarks or trademarks of Microsoft Corporation in the United States and other countries.
- EtherCAT® is registered trademark and patented technology, licensed by Beckhoff Automation GmbH, Germany.
- ODVA, CIP, CompoNet, DeviceNet, and EtherNet/IP are trademarks of ODVA.

Other company names and product names in this document are the trademarks or registered trademarks of their respective companies.

Copyrights

- Microsoft product screen shots used with permission from Microsoft.
- This product incorporates certain third party software. The license and copyright information associated with this software is available at http://www.fa.omron.co.jp/nj_info_e/.

Introduction

This guide describes how to replace your CS/CJ-series EtherNet/IP Units or built-in EtherNet/IP ports and Ethernet Units with security-enhanced models. However, this guide does not provide details on the use of the products, including safety precautions. Before you perform actual replacement, be sure to obtain the user's manuals for both the source and target replacement models, read the safety precautions and other details on use, and thoroughly check their operations.

Note that this guide is intended for those who have a knowledge of the CS/CJ-series PLCs and experience in designing equipment that uses the products. Refer to the manuals listed in *Related Manuals* on page 16 for details on operating procedures.

Intended Audience

This guide is intended for the following personnel, who must also have knowledge of electrical systems (an electrical engineer or the equivalent).

- Personnel in charge of introducing FA systems.
- Personnel in charge of designing FA systems.
- Personnel in charge of installing and maintaining FA systems.
- Personnel in charge of managing FA systems and facilities.

Note that this guide is intended for those who have a knowledge of the CS/CJ-series PLCs and experience in designing equipment that uses the products. Refer to the manuals listed in *Related Manuals* on page 16 for details on operating procedures.

Applicable Products

This guide covers the following products.

Source replacement models:

- CJ-series CJ2 CPU built-in EtherNet/IP port
CJ2H-CPU6□-EIP, CJ2M-CPU3□
- CS/CJ-series EtherNet/IP Unit
CJ1W-EIP21, CS1W-EIP21
- CS/CJ/CS1D-series Ethernet Unit
CJ1W-ETN21, CS1W-ETN21, CS1D-ETN21D

Target replacement models:

- CJ-series CJ2 CPU Unit
CJ2H-CPU6□, CJ2M-CPU1□
- CS/CJ-series EtherNet/IP Unit
CJ1W-EIP21S, CS1W-EIP21S

Manual Structure

Page Structure

The following page structure is used in this manual.

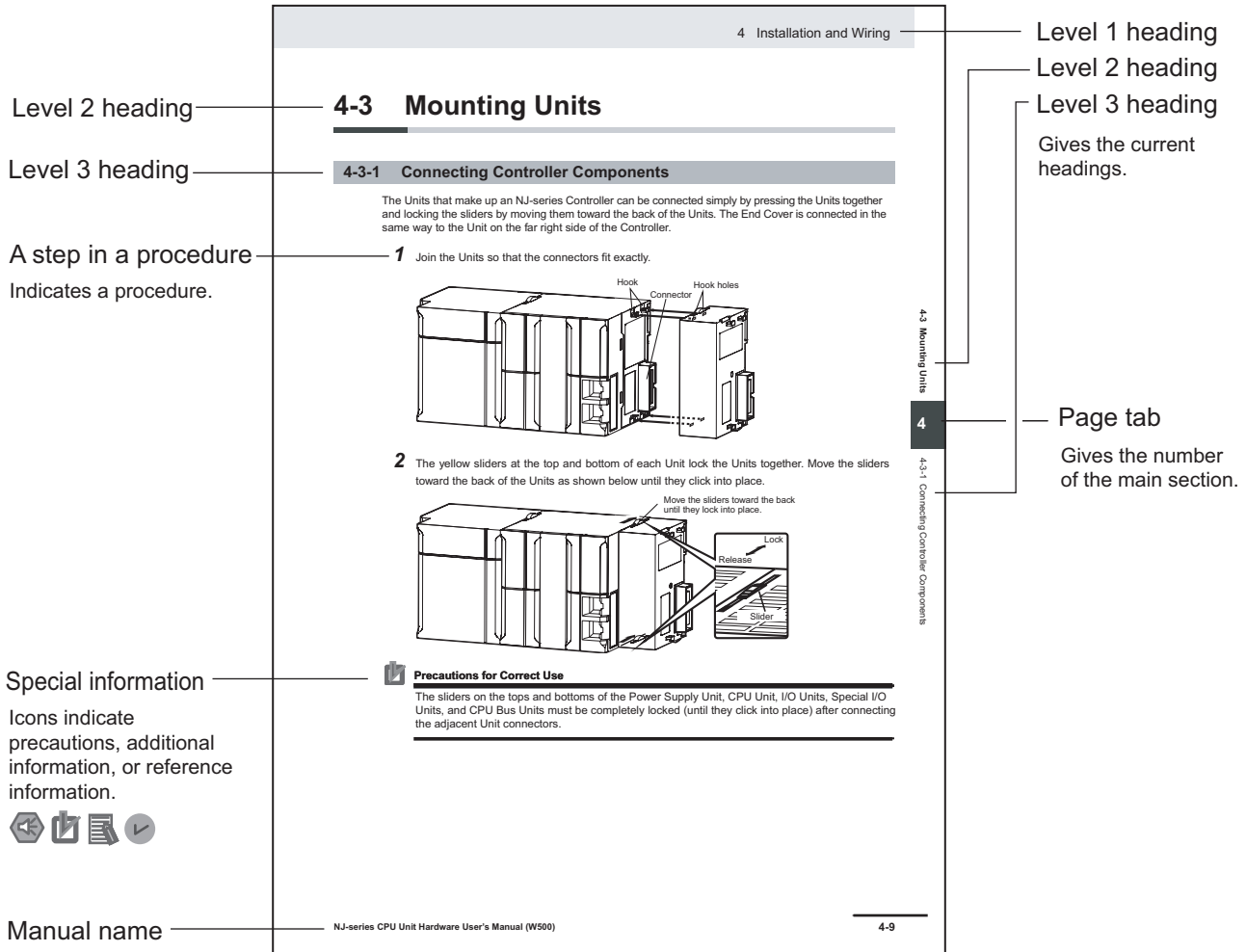

Note This illustration is provided only as a sample. It may not literally appear in this manual.

Special Information

Special information in this manual is classified as follows:



Precautions for Safe Use

Precautions on what to do and what not to do to ensure safe usage of the product.



Precautions for Correct Use

Precautions on what to do and what not to do to ensure proper operation and performance.



Additional Information

Additional information to read as required.

This information is provided to increase understanding or make operation easier.



Version Information

Information on differences in specifications and functionality for applicable products with different unit versions and for different versions of the Support Software is given.

Sections in this Manual

1	Source and Target Replacement Models	1
2	Replacing a System with the CJ2 CPU Built-in EtherNet/IP Port	2
3	Replacing a System with the C□1W-EIP21	3
4	Replacing a System with the C□1W-ETN21	4
5	Replacing a System with the CS1D-ETN21D	5
A	Appendices	A
I	Index	I

CONTENTS

Introduction	1
Intended Audience	1
Applicable Products	1
Manual Structure.....	2
Page Structure	2
Special Information	3
Sections in this Manual	5
Terms and Conditions Agreement.....	9
Warranty, Limitations of Liability	9
Application Considerations	10
Disclaimers	10
Statement of security responsibilities for assumed use cases and against threats.....	11
Safety Precautions.....	12
Definition of Precautionary Information.....	12
Symbols	12
Warnings.....	13
Cautions.....	13
Precautions for Safe Use	14
Precautions for Correct Use	15
Related Manuals.....	16
Revision History.....	19

Section 1 Source and Target Replacement Models

1-1 Source Replacement Models	1-2
1-2 Target Replacement Models	1-3
1-2-1 System with the CJ2 CPU Built-in EtherNet/IP Port.....	1-3
1-2-2 System with the C□1W-EIP21.....	1-8
1-2-3 System with the C□1W-ETN21	1-9
1-2-4 System with the CS1D-ETN21D	1-11
1-3 Support Software	1-13

Section 2 Replacing a System with the CJ2 CPU Built-in EtherNet/IP Port

2-1 Differences in Specifications, Functions, Etc.....	2-2
2-1-1 Differences in a System with the CJ2H-CPU6□-EIP	2-2
2-1-2 Differences in a System with the CJ2M-CPU3□.....	2-8
2-2 Replacement Flow	2-16
2-2-1 Flow of Preparation	2-16
2-2-2 Flow of Replacement	2-17
2-3 Preparation.....	2-19

2-3-1	Checking the Target Replacement Model	2-19
2-3-2	Checking the Differences in Specifications, Functions, Etc.	2-19
2-3-3	Getting the Support Software	2-19
2-3-4	Reading and Saving Data	2-19
2-3-5	Changing the PLC	2-26
2-3-6	Creating an I/O Table	2-28
2-3-7	Selecting the Power Supply Unit and Checking the Dimensions	2-32
2-3-8	Setting Up the CPU Unit	2-36
2-3-9	Setting Up the C□1W-EIP21S	2-38
2-3-10	Setting Up Other Units	2-40
2-3-11	Correcting PLC Memory	2-42
2-3-12	Correcting the User Program	2-44
2-3-13	Configuring Tag Data Links	2-44
2-4	Replacement.....	2-47
2-4-1	Replacing and Wiring Units	2-47
2-4-2	Turning ON the Power Supply	2-48
2-4-3	Transferring Data	2-49
2-4-4	Checking the Operation	2-55
2-4-5	Implementing Security Measures	2-55
2-4-6	Checking the Operation after Implementing Security Measures	2-58

Section 3 Replacing a System with the C□1W-EIP21

3-1	Differences in Specifications, Functions, Etc.	3-2
3-2	Replacement Flow	3-10
3-2-1	Flow of Preparation	3-10
3-2-2	Flow of Replacement	3-11
3-3	Preparation	3-12
3-3-1	Checking the Target Replacement Model	3-12
3-3-2	Checking the Differences in Specifications, Functions, Etc.	3-12
3-3-3	Getting the Support Software	3-12
3-3-4	Reading and Saving Data	3-12
3-3-5	Creating an I/O Table	3-13
3-3-6	Selecting the Power Supply Unit and Checking the Dimensions	3-14
3-3-7	Setting Up the CPU Unit	3-14
3-3-8	Setting Up the C□1W-EIP21S	3-14
3-3-9	Correcting the User Program	3-14
3-3-10	Configuring Tag Data Links	3-14
3-4	Replacement.....	3-15
3-4-1	Replacing and Wiring Units	3-15
3-4-2	Turning ON the Power Supply	3-15
3-4-3	Transferring the I/O Table.....	3-15
3-4-4	Transferring Data	3-17
3-4-5	Checking the Operation	3-18
3-4-6	Implementing Security Measures	3-19
3-4-7	Checking the Operation after Implementing Security Measures	3-19

Section 4 Replacing a System with the C□1W-ETN21

4-1	Differences and Changes in Specifications and Functions.....	4-2
4-1-1	Differences in Specifications and Functions.....	4-2
4-1-2	Changes during Replacement.....	4-4
4-2	Replacement Flow	4-6
4-2-1	Flow of Preparation	4-6
4-2-2	Flow of Replacement	4-7
4-3	Preparation	4-9
4-3-1	Checking the Target Replacement Model	4-9
4-3-2	Checking the Differences in Specifications, Functions, Etc.	4-9

4-3-3	Getting the Support Software	4-9
4-3-4	Reading and Saving Data	4-9
4-3-5	Creating an I/O Table	4-10
4-3-6	Selecting the Power Supply Unit and Checking the Dimensions	4-10
4-3-7	Configuring Special Unit Settings	4-11
4-3-8	Editing PLC Settings	4-19
4-3-9	Editing the User Program	4-20
4-3-10	Editing Allocated CIO Area or DM Area Words	4-26
4-3-11	Saving the Project File	4-27
4-4	Replacement.....	4-28
4-4-1	Replacing and Wiring Units	4-28
4-4-2	Turning ON the Power Supply	4-28
4-4-3	Transferring the I/O Table	4-28
4-4-4	Transferring Data (to PLC)	4-30
4-4-5	Checking the Operation	4-30
4-4-6	Implementing Security Measures	4-30
4-4-7	Checking the Operation after Implementing Security Measures	4-30

Section 5 Replacing a System with the CS1D-ETN21D

5-1	Differences and Changes in Specifications and Functions.....	5-2
5-1-1	Differences in Specifications and Functions	5-2
5-1-2	Changes during Replacement	5-5
5-2	Replacement Flow	5-6
5-2-1	Flow of Preparation	5-6
5-2-2	Flow of Replacement	5-7
5-3	Preparation	5-9
5-3-1	Checking the Target Replacement Model	5-9
5-3-2	Checking the Differences in Specifications, Functions, Etc.	5-9
5-3-3	Getting the Support Software	5-9
5-3-4	Reading and Saving Data	5-9
5-3-5	Creating an I/O Table	5-12
5-3-6	Selecting the Power Supply Unit and Checking the Dimensions	5-13
5-3-7	Editing the Routing Table	5-13
5-3-8	Configuring Special Unit Settings	5-14
5-3-9	Editing PLC Settings	5-17
5-3-10	Editing the User Program	5-18
5-3-11	Editing Allocated CIO Area or DM Area Words	5-22
5-3-12	Saving the Project File	5-23
5-4	Replacement.....	5-24
5-4-1	Replacing and Wiring Units	5-24
5-4-2	Turning ON the Power Supply	5-24
5-4-3	Resetting Errors	5-24
5-4-4	Transferring Data (to PLC)	5-26
5-4-5	Checking the Operation	5-29
5-4-6	Implementing Security Measures	5-29
5-4-7	Checking the Operation after Implementing Security Measures	5-30

Appendices

A-1	Duplex Communications Sample Programming.....	A-2
A-1-1	System Configuration	A-2
A-1-2	Sample Programming	A-2

Index

Terms and Conditions Agreement

Warranty, Limitations of Liability

Warranties

- **Exclusive Warranty**

Omron's exclusive warranty is that the Products will be free from defects in materials and workmanship for a period of twelve months from the date of sale by Omron (or such other period expressed in writing by Omron). Omron disclaims all other warranties, express or implied.

- **Limitations**

OMRON MAKES NO WARRANTY OR REPRESENTATION, EXPRESS OR IMPLIED, ABOUT NON-INFRINGEMENT, MERCHANTABILITY OR FITNESS FOR A PARTICULAR PURPOSE OF THE PRODUCTS. BUYER ACKNOWLEDGES THAT IT ALONE HAS DETERMINED THAT THE PRODUCTS WILL SUITABLY MEET THE REQUIREMENTS OF THEIR INTENDED USE.

Omron further disclaims all warranties and responsibility of any type for claims or expenses based on infringement by the Products or otherwise of any intellectual property right.

- **Buyer Remedy**

Omron's sole obligation hereunder shall be, at Omron's election, to (i) replace (in the form originally shipped with Buyer responsible for labor charges for removal or replacement thereof) the non-complying Product, (ii) repair the non-complying Product, or (iii) repay or credit Buyer an amount equal to the purchase price of the non-complying Product; provided that in no event shall Omron be responsible for warranty, repair, indemnity or any other claims or expenses regarding the Products unless Omron's analysis confirms that the Products were properly handled, stored, installed and maintained and not subject to contamination, abuse, misuse or inappropriate modification. Return of any Products by Buyer must be approved in writing by Omron before shipment. Omron Companies shall not be liable for the suitability or unsuitability or the results from the use of Products in combination with any electrical or electronic components, circuits, system assemblies or any other materials or substances or environments. Any advice, recommendations or information given orally or in writing, are not to be construed as an amendment or addition to the above warranty.

See <http://www.omron.com/global/> or contact your Omron representative for published information.

Limitation on Liability; Etc

OMRON COMPANIES SHALL NOT BE LIABLE FOR SPECIAL, INDIRECT, INCIDENTAL, OR CONSEQUENTIAL DAMAGES, LOSS OF PROFITS OR PRODUCTION OR COMMERCIAL LOSS IN ANY

WAY CONNECTED WITH THE PRODUCTS, WHETHER SUCH CLAIM IS BASED IN CONTRACT, WARRANTY, NEGLIGENCE OR STRICT LIABILITY.

Further, in no event shall liability of Omron Companies exceed the individual price of the Product on which liability is asserted.

Application Considerations

Suitability of Use

Omron Companies shall not be responsible for conformity with any standards, codes or regulations which apply to the combination of the Product in the Buyer's application or use of the Product. At Buyer's request, Omron will provide applicable third party certification documents identifying ratings and limitations of use which apply to the Product. This information by itself is not sufficient for a complete determination of the suitability of the Product in combination with the end product, machine, system, or other application or use. Buyer shall be solely responsible for determining appropriateness of the particular Product with respect to Buyer's application, product or system. Buyer shall take application responsibility in all cases.

NEVER USE THE PRODUCT FOR AN APPLICATION INVOLVING SERIOUS RISK TO LIFE OR PROPERTY OR IN LARGE QUANTITIES WITHOUT ENSURING THAT THE SYSTEM AS A WHOLE HAS BEEN DESIGNED TO ADDRESS THE RISKS, AND THAT THE OMRON PRODUCT(S) IS PROPERLY RATED AND INSTALLED FOR THE INTENDED USE WITHIN THE OVERALL EQUIPMENT OR SYSTEM.

Programmable Products

Omron Companies shall not be responsible for the user's programming of a programmable Product, or any consequence thereof.

Disclaimers

Performance Data

Data presented in Omron Company websites, catalogs and other materials is provided as a guide for the user in determining suitability and does not constitute a warranty. It may represent the result of Omron's test conditions, and the user must correlate it to actual application requirements. Actual performance is subject to the Omron's Warranty and Limitations of Liability.

Change in Specifications

Product specifications and accessories may be changed at any time based on improvements and other reasons. It is our practice to change part numbers when published ratings or features are changed, or when significant construction changes are made. However, some specifications of the Product may

be changed without any notice. When in doubt, special part numbers may be assigned to fix or establish key specifications for your application. Please consult with your Omron's representative at any time to confirm actual specifications of purchased Product.

Errors and Omissions

Information presented by Omron Companies has been checked and is believed to be accurate; however, no responsibility is assumed for clerical, typographical or proofreading errors or omissions.

Statement of security responsibilities for assumed use cases and against threats

OMRON SHALL NOT BE RESPONSIBLE AND/OR LIABLE FOR ANY LOSS, DAMAGE, OR EXPENSES DIRECTLY OR INDIRECTLY RESULTING FROM THE INFECTION OF OMRON PRODUCTS, ANY SOFTWARE INSTALLED THEREON OR ANY COMPUTER EQUIPMENT, COMPUTER PROGRAMS, NETWORKS, DATABASES OR OTHER PROPRIETARY MATERIAL CONNECTED THERETO BY DISTRIBUTED DENIAL OF SERVICE ATTACK, COMPUTER VIRUSES, OTHER TECHNOLOGICALLY HARMFUL MATERIAL AND/OR UNAUTHORIZED ACCESS.

It shall be the users sole responsibility to determine and use adequate measures and checkpoints to satisfy the users particular requirements for (i) antivirus protection, (ii) data input and output, (iii) maintaining a means for reconstruction of lost data, (iv) preventing Omron Products and/or software installed thereon from being infected with computer viruses and (v) protecting Omron Products from unauthorized access.



Safety Precautions

Definition of Precautionary Information





The following notation is used in this manual to provide precautions required to ensure safe usage of the source and target replacement models of CS/CJ-series Programmable Controllers.

The safety precautions that are provided are extremely important to safety. Always read and heed the information provided in all safety precautions.

The following notation is used.

 WARNING	<p>Indicates a potentially hazardous situation which, if not avoided, could result in death or serious injury. Additionally, there may be severe property damage.</p>
 Caution	<p>Indicates a potentially hazardous situation which, if not avoided, may result in minor or moderate injury, or property damage.</p>

Symbols

	<p>The circle and slash symbol indicates operations that you must not do. The specific operation is shown in the circle and explained in text. This example indicates prohibiting disassembly.</p>
	<p>The triangle symbol indicates precautions (including warnings). The specific operation is shown in the triangle and explained in text. This example indicates a precaution for electric shock.</p>
	<p>The triangle symbol indicates precautions (including warnings). The specific operation is shown in the triangle and explained in text. This example indicates a general precaution.</p>
	<p>The filled circle symbol indicates operations that you must do. The specific operation is shown in the circle and explained in text. This example shows a general precaution for something that you must do.</p>

Warnings



Refer to the following manuals for warnings.

Source replacement models

Series	Unit name	Model numbers	Manual name
CJ Series	CJ2 CPU built-in EtherNet/IP port	CJ2H-CPU6□-EIP CJ2M-CPU3□	<ul style="list-style-type: none"> • <i>CJ-series CJ2 CPU Unit Hardware User's Manual (Cat. No. W472)</i> • <i>CJ-series CJ2 CPU Unit Software User's Manual (Cat. No. W473)</i> • <i>CS/CJ-series EtherNet/IP Units Operation Manual (Cat. No. W465)</i>
CS/CJ Series	EtherNet/IP Unit	CJ1W-EIP21 CS1W-EIP21	<i>CS/CJ-series EtherNet/IP Units Operation Manual (Cat. No. W465)</i>
CS/CJ Series	Ethernet Unit	CJ1W-ETN21 CS1W-ETN21	<ul style="list-style-type: none"> • <i>Ethernet Units Operation Manual Construction of Networks (Cat. No. W420)</i> • <i>Ethernet Units Operation Manual Construction of Applications (Cat. No. W421)</i>
CS1D Series	CS1D Ethernet Unit	CS1D-ETN21D	<i>CS-series Ethernet Units for CS1D PLCs Operation Manual (Cat. No. W430)</i>

Target replacement models

Series	Unit name	Model numbers	Manual name
CJ Series	CJ2 CPU Unit	CJ2H-CPU6□ CJ2M-CPU1□	<ul style="list-style-type: none"> • <i>CJ-series CJ2 CPU Unit Hardware User's Manual (Cat. No. W472)</i> • <i>CJ-series CJ2 CPU Unit Software User's Manual (Cat. No. W473)</i>
CS/CJ Series	EtherNet/IP Unit	CJ1W-EIP21S CS1W-EIP21S	<i>CS/CJ-series EtherNet/IP Units Operation Manual (Cat. No. W465)</i>

Cautions



Refer to the manuals shown in *Warnings* on page 13 for cautions.

Precautions for Safe Use

Refer to the manuals shown in *Warnings* on page 13 for precautions for safe use.

Precautions for Correct Use

Refer to the manuals shown in *Warnings* on page 13 for precautions for correct use.

Related Manuals

The following table shows the manuals related to this product. Use these manuals for reference.

Manual name	Cat. No.	Model numbers	Application	Description
CX-Programmer Ver. 9.□ Operation Manual	W446	CXONE-AL□□D-V4	Learning how to operate the CX-Programmer, i.e., a programming tool for Windows computers.	Describes the operating procedures of the CX-Programmer.
CX-One Setup Manual	W463	CXONE-AL□□D-V4/LT□□□-V4	Installing the CX-One software.	Provides an overview of the CX-One FA Integrated Tool Package and describes how to install the CX-One.
CS/CJ/CP/NSJ-series CX-Integrator Ver. 2.□ Operation Manual	W464	CXONE-AL□□D-V4	Learning about network configuration (data links, routing tables, Communications Unit settings, etc.).	Describes the operating procedures of the CX-Integrator.
CS/CJ-series EtherNet/IP™ Units Operation Manual	W465	CS1W-EIP21 CJ1W-EIP21 CJ2H-CPU6□-EIP CJ2M-CPU3□ CS1W-EIP21S CJ1W-EIP21S	Learning how to use an EtherNet/IP Unit.	Provides information on using an EtherNet/IP Unit that is connected to a CS/CJ-series CPU Unit. The basic setup, tag data links, and FINS communications are described.
CJ-series Programmable Controllers Operation Manual	W393	CJ1H-CPU□□H-R CJ1G/H-CPU□□H CJ1G-CPU□□P CJ1M-CPU□□ CJ1G-CPU□□	Learning the basic specifications of the CJ Series, including introductory information, designing, installation, and maintenance.	Provides the following information on the CJ-series CPU Units. <ul style="list-style-type: none"> • Overview and features • System configuration • Installation and wiring • I/O memory allocations • Remedies for errors Use this manual together with the <i>CS/CJ/NSJ-series Programmable Controllers Programming Manual (Cat. No. W394)</i> .
CJ-series CJ2 CPU Unit Software User's Manual	W473	CJ2H-CPU6□-EIP CJ2H-CPU6□ CJ2M-CPU□□	Learning the functions and application methods of the CJ2-series PLC software.	Provides the following information on the CJ2 CPU Units. <ul style="list-style-type: none"> • CPU Unit operation • Internal memory • Programming • Settings • Function built into the CPU Unit Use this manual together with the <i>CJ-series CJ2 CPU Unit Hardware User's Manual (Cat. No. W472)</i> .

Manual name	Cat. No.	Model numbers	Application	Description
CJ-series CJ2 CPU Unit Hardware User's Manual	W472	CJ2H-CPU6□-EIP CJ2H-CPU6□ CJ2M-CPU□□	Learning the functions and application methods of the CJ2-series PLC hardware.	Provides the following information on the CJ2 CPU Units. <ul style="list-style-type: none"> • Overview and features • Basic system configuration • Part names and functions • Mounting and setting procedure • Remedies for errors Use this manual together with the <i>CJ-series CJ2 CPU Unit Software User's Manual (Cat. No. W473)</i> .
CS-series Programmable Controllers Operation Manual	W339	CS1G/H-CPU□□H	Learning the basic specifications of the CS Series, including introductory information, designing, installation, and maintenance.	Provides the following information on the CS-series CPU Units. <ul style="list-style-type: none"> • Overview and features • System configuration • Installation and wiring • I/O memory allocations • Remedies for errors Use this manual together with the <i>CS/CJ/NSJ-series Programmable Controllers Programming Manual (Cat. No. W394)</i> .
CS/CJ/NSJ-series Programmable Controllers Programming Manual	W394	CS1G/H-CPU□□H CS1G/H-CPU□□-V1 CS1D-CPU□ □HA/H CS1D-CPU□ □SA/S CS1D-CPU□□P CJ1H-CPU□□H-R CJ1G/H-CPU□□H CJ1G-CPU□□P CJ1M-CPU□□ CJ1G-CPU□□ NSJ□-□□□□(B)-G5D NSJ□-□□□□(B)-M3D	Learning about the functions of the CS/CJ/NSJ Series.	Provides the following information on the CS/CJ/NSJ-series CPU Units. <ul style="list-style-type: none"> • Programming • Tasks • File memory • Functions Use this manual together with the <i>Programmable Controllers Operation Manual (Cat. No. W339 for CS Series or Cat. No. W393 for CJ Series)</i> .
CS1D Duplex System Operation Manual	W405	CS1D-CPU□ □HA/H CS1D-CPU□ □SA/S CS1D-DPL01/02D CS1D-PA/PD□□□	Learning the basic specifications of the CS1D Duplex System, including introductory information, designing, installation, and maintenance, as well as duplex-related matters.	Provides the following information on the CS1D Duplex System. <ul style="list-style-type: none"> • Overview and features • System configuration • Duplex system • Installation and wiring • I/O memory allocations • Remedies for errors The operating procedures of the Programming Console for replacing Units online are also described. Use this manual together with the <i>CS/CJ/NSJ-series Programmable Controllers Programming Manual (Cat. No. W394)</i> .

Manual name	Cat. No.	Model numbers	Application	Description
Ethernet Units Operation Manual Construction of Networks	W420	CS1W-ETN21 CJ1W-ETN21	Using the Ethernet Units.	Provides information on the Ethernet Units. The basic setup and FINS communications are described. Refer to the <i>CS/CJ/CP/NSJ-series Communications Commands Reference Manual (Cat. No. W342)</i> for details on FINS commands that are sent to CS/CJ-series CPU Units via FINS communications service.
Ethernet Units Operation Manual Construction of Applications	W421	CS1W-ETN21 CJ1W-ETN21	Using the Ethernet Units.	Provides information on creating a host application for the mail send/receive, socket service, automatic clock adjustment, FTP server, and FINS communications functions.
CS-series Ethernet Units for CS1D PLCs Operation Manual	W430	CS1D-ETN21D	Using the Ethernet Units.	Provides information on the Ethernet Units. The basic setup and FINS communications are described. When using FINS communications service: Refer to the <i>CS/CJ/CP/NSJ-series Communications Commands Reference Manual (Cat. No. W342)</i> for details on FINS commands that are sent to CPU Units.

Revision History

A manual revision code appears as a suffix to the catalog number on the front and back covers of the manual.

Cat. No. P152-E1-01

↑
Revision code

Revision code	Date	Revised content
01	July 2023	Original production

1

Source and Target Replacement Models

This section provides information on source and target replacement models and Support Software.

1-1	Source Replacement Models	1-2
1-2	Target Replacement Models	1-3
1-2-1	System with the CJ2 CPU Built-in EtherNet/IP Port.....	1-3
1-2-2	System with the C□1W-EIP21	1-8
1-2-3	System with the C□1W-ETN21	1-9
1-2-4	System with the CS1D-ETN21D	1-11
1-3	Support Software	1-13

1-1 Source Replacement Models

The table below provides information on source replacement models. It also shows for each source replacement model where in this guide the replacement information is available.

Source replacement model				Reference for replacement information	
Series	Unit name	Model numbers	Remarks	Target replacement model	Replacement procedure
CJ Series	CJ2 CPU built-in EtherNet/IP port*1	CJ2H-CPU6□-EIP CJ2M-CPU3□	---	1-2-1 System with the CJ2 CPU Built-in EtherNet/IP Port on page 1-3	Section 2 Replacing a System with the CJ2 CPU Built-in EtherNet/IP Port on page 2-1
CS/CJ Series	EtherNet/IP Unit*1	CJ1W-EIP21 CS1W-EIP21	This guide does not apply if the CJ1W-EIP21 is mounted on the following CPU Units. <ul style="list-style-type: none"> • CP1H-series CPU Units • NJ-series CPU Units • CJ1M-CPU□□ • CJ1H-CPU□□H-R • CJ1G/H-CPU□□H • CJ1G-CPU□□ 	1-2-2 System with the C□1W-EIP21 on page 1-8	Section 3 Replacing a System with the C□1W-EIP21 on page 3-1
CS/CJ Series	Ethernet Unit	CJ1W-ETN21 CS1W-ETN21	This guide does not apply if the CJ1W-ETN21 is mounted on the following CPU Units. <ul style="list-style-type: none"> • CP1H-series CPU Units • CJ1M-CPU□□ • CJ1H-CPU□□H-R • CJ1G/H-CPU□□H • CJ1G-CPU□□ 	1-2-3 System with the C□1W-ETN21 on page 1-9	Section 4 Replacing a System with the C□1W-ETN21 on page 4-1
CS1D Series	CS1D Ethernet Unit	CS1D-ETN21D	---	1-2-4 System with the CS1D-ETN21D on page 1-11	Section 5 Replacing a System with the CS1D-ETN21D on page 5-1

*1. In this guide, the CJ-series CJ2 CPU built-in EtherNet/IP port and CS/CJ-series EtherNet/IP Unit are collectively referred to as "EtherNet/IP Unit or built-in EtherNet/IP port".

The next section provides information on target replacement models for the above source replacement models.

1-2 Target Replacement Models

This section provides information on target replacement models for each system that uses one of the listed source replacement models.



Precautions for Correct Use

The external dimensions, specifications, programs and settings, etc. are subject to change due to replacement depending on the source replacement model and operating conditions. For details, in addition to this guide, refer to the user's manuals for both the source and target replacement models.

1-2-1 System with the CJ2 CPU Built-in EtherNet/IP Port

This section provides information on the target replacement models when CJ2H-CPU6□-EIP and CJ2M-CPU3□ are the source replacement models. The description is given for each model.

System with the CJ2H-CPU6□-EIP

Source replacement model	Target replacement model	Remarks
CJ2H-CPU6□-EIP*1	CJ2H-CPU6□*1 + CJ1W-EIP21S	If network symbols are used, use the CPU Unit with unit version 1.6 or later.

- *1. The wildcard character "□" in the CPU Unit model is a number between 4 and 8, which differs depending on the program capacity and data memory capacity. Basically, for the target replacement model, choose a CPU Unit model with the same number as that of the source replacement model.
Example: Replace the CJ2H-CPU68-EIP with the CJ2H-CPU68.

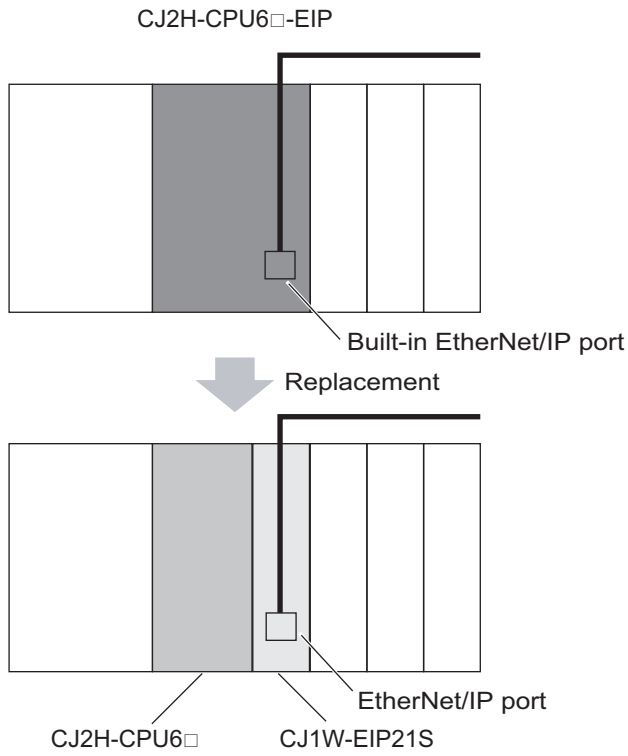

A replacement example is shown below.

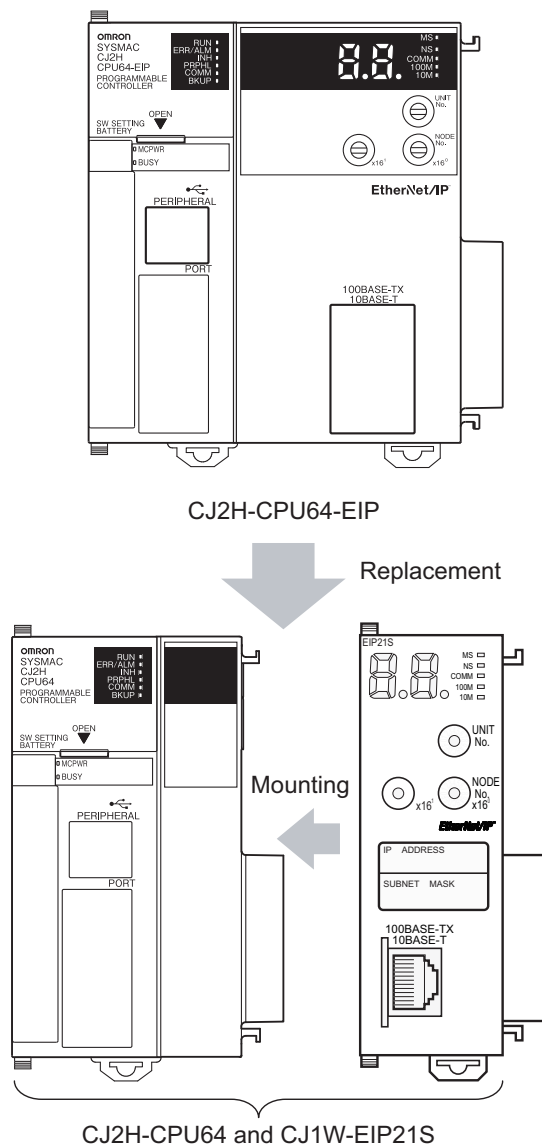

If the CJ1W-EIP21 is mounted, replace it with the CJ1W-EIP21S.
 Refer to 1-3 Support Software on page 1-13 for information on Support Software that supports the target replacement models.

System with the CJ2M-CPU3□

Source replacement model	Target replacement model	Remarks
CJ2M-CPU3□*1	CJ2M-CPU1□*1 + CJ1W-EIP21S	If network symbols are used, use the CPU Unit with unit version 2.2 or later. If a Serial Option Board is used, refer to <i>Replacement When a Serial Option Board Is Used</i> on page 1-7.

*1. The wildcard character "□" in the CPU Unit model is a number between 1 and 5, which differs depending on the program capacity and data memory capacity. Basically, for the target replacement model, choose a CPU Unit model with the same number as that of the source replacement model.
 Example: Replace the CJ2M-CPU35 with the CJ2M-CPU15.

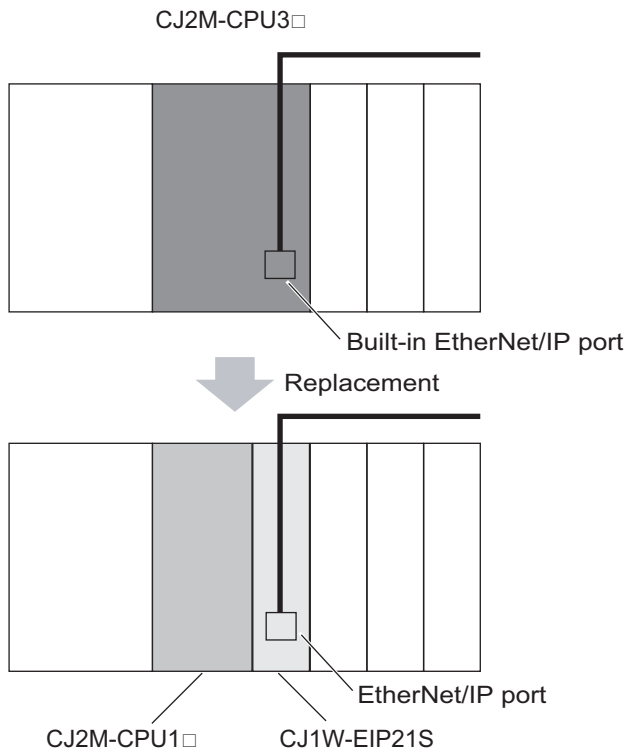

A replacement example is shown below.

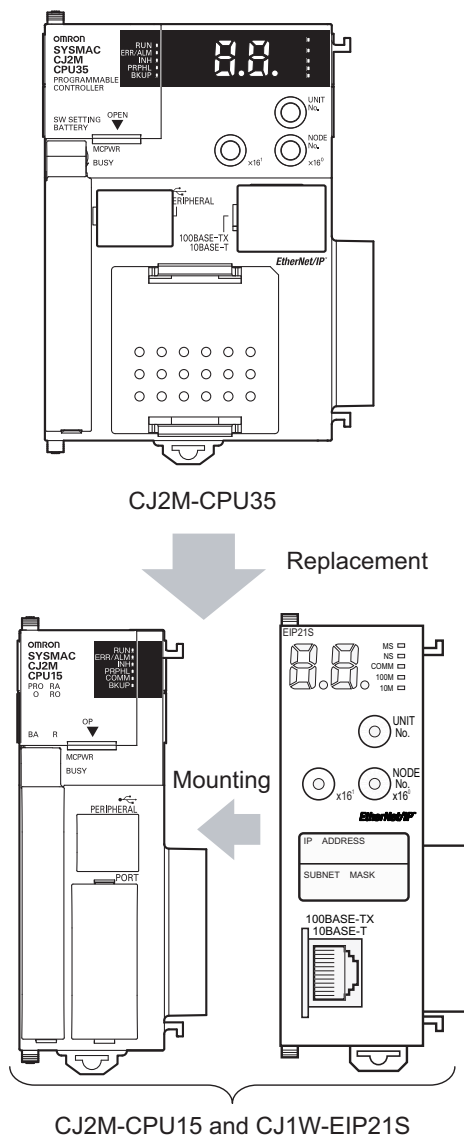

If the CJ1W-EIP21 is mounted, replace it with the CJ1W-EIP21S. However, you can mount up to two CJ1W-EIP21S Units on the CJ2M-CPU1□.

Refer to 1-3 *Support Software* on page 1-13 for information on Support Software that supports the target replacement models.

● **Replacement When a Serial Option Board Is Used**

If a Serial Option Board (CP1W-CIF□□) is used with the source replacement model CJ2M-CPU3□, a configuration change is required.

The table below shows what configuration change is required for the target replacement model CPU Unit.

Source replacement model	Configuration change
CP1W-CIF01 (RS-232C)	Use the built-in RS-232C interface on the CJ2M-CPU1□.
CP1W-CIF11 (RS-422A/485 (non-isolated))	Change the configuration to directly connect an RS-422A Converter (CJ1W-CIF11) to the built-in RS-232C interface on the CJ2M-CPU1□.

Source replacement model	Configuration change
CP1W-CIF12 (RS-422A/485 (isolated))	Change the configuration to connect the built-in RS-232C interface on the CJ2M-CPU1□ and an RS-232C/RS-422A Converter (NT-AL001) with a cable.

Refer to *Connecting to a Serial Port on the CPU Unit* in Appendices of the *CJ-series CJ2 CPU Unit Hardware User's Manual (Cat. No. W472)* for details on connecting to a serial port on the CJ2-series CPU Unit.

1-2-2 System with the C□1W-EIP21

The table below shows the target replacement models when CJ1W-EIP21 and CS1W-EIP21 are the source replacement models.

Source replacement model	Target replacement model
CJ1W-EIP21	CJ1W-EIP21S
CS1W-EIP21	CS1W-EIP21S

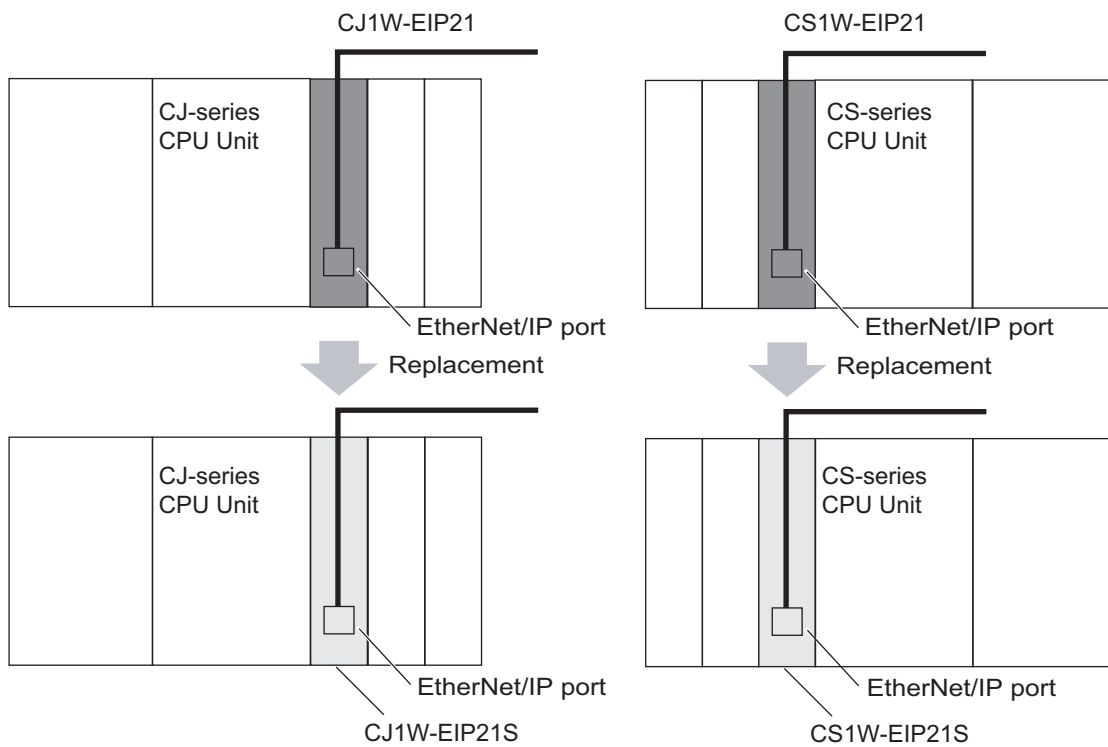

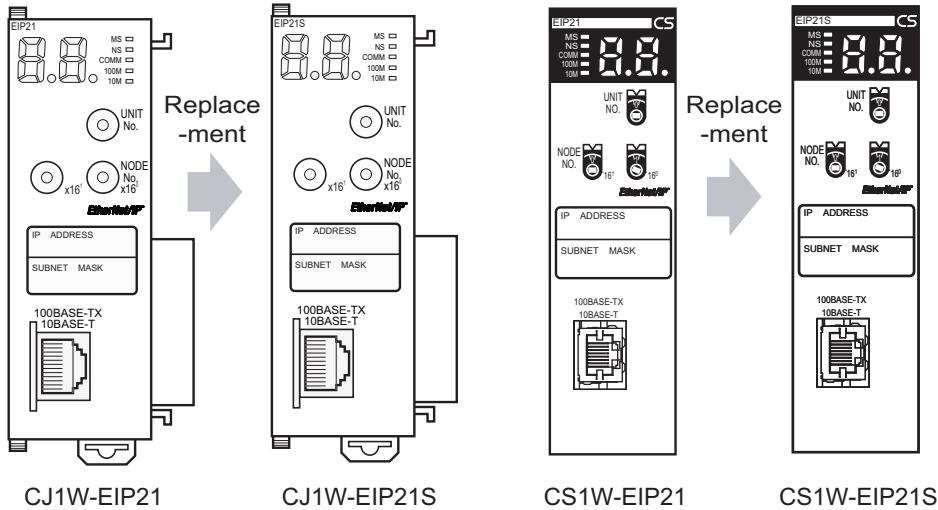

Refer to 1-3 Support Software on page 1-13 for information on Support Software that supports the target replacement models.



Precautions for Correct Use

The CJ1W-EIP21S cannot be mounted on NJ-series CPU Units. In addition, the operation of the CJ1W-EIP21S is not guaranteed if it is mounted on the following CPU Units.

- CP1H-series CPU Units
- CJ1M-CPU□□
- CJ1H-CPU□□H-R
- CJ1G/H-CPU□□H
- CJ1G-CPU□□

Therefore, the CJ1W-EIP21 cannot be replaced with the CJ1W-EIP21S when it is mounted on these CPU Units.

1-2-3 System with the C□1W-ETN21

The table below shows the target replacement models when CJ1W-ETN21 and CS1W-ETN21 are the source replacement models. Replace the Ethernet Units with security-enhanced EtherNet/IP Units.

Source replacement model	Target replacement model
CJ1W-ETN21	CJ1W-EIP21S
CS1W-ETN21	CS1W-EIP21S

1 Source and Target Replacement Models

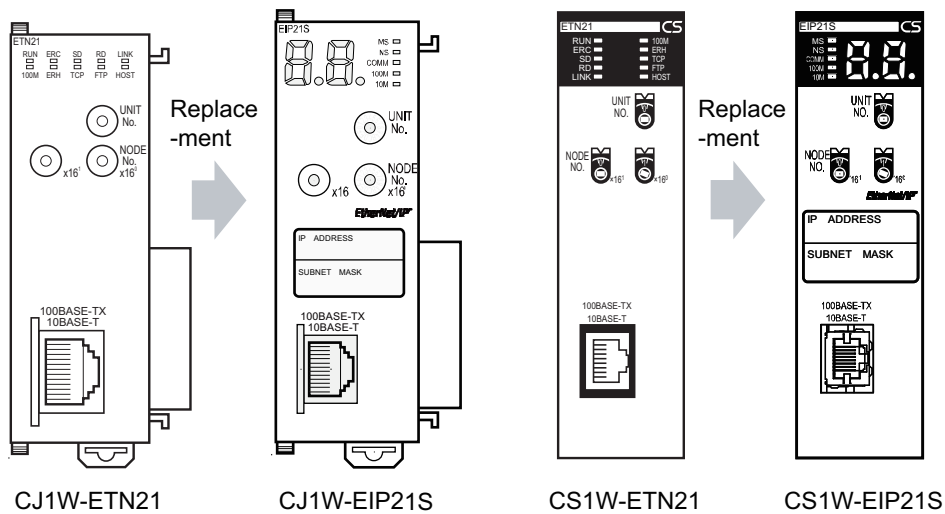
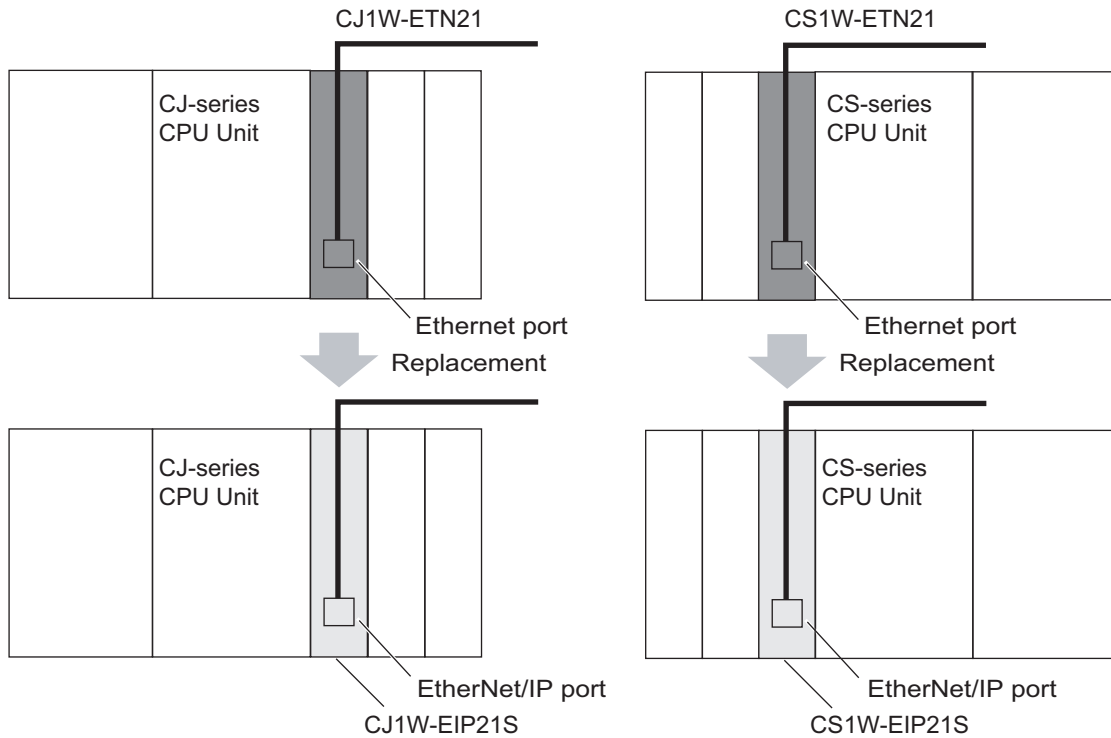

Note The above appearance of the CJ1W-ETN21 is for unit version 1.5 or later. Refer to the *Ethernet Units Operation Manual Construction of Networks (Cat. No. W420)* for the appearance of unit version 1.4 or earlier.

Refer to 1-3 Support Software on page 1-13 for information on Support Software that supports the target replacement models.



Precautions for Correct Use

- The CJ1W-EIP21S cannot be mounted on NJ-series CPU Units. In addition, the operation of the CJ1W-EIP21S is not guaranteed if it is mounted on the following CPU Units.
 CP1H-series CPU Units
 CJ1M-CPU□□
 CJ1H-CPU□□H-R
 CJ1G/H-CPU□□H
 CJ1G-CPU□□
 Therefore, the CJ1W-ETN21 cannot be replaced with the CJ1W-EIP21S when it is mounted on these CPU Units.
- The □□1W-EIP21S does not support the mail send/receive and web functions supported by the □□1W-ETN21. If the mail send/receive and web functions are used in the system with the source replacement model □□1W-ETN21, you cannot perform replacement.

1-2-4 System with the CS1D-ETN21D

The table below shows the target replacement model when CS1D-ETN21D is the source replacement model. Replace the CS1D Ethernet Units with security-enhanced EtherNet/IP Units.

Source replacement model	Target replacement model
CS1D-ETN21D	CS1W-EIP21S

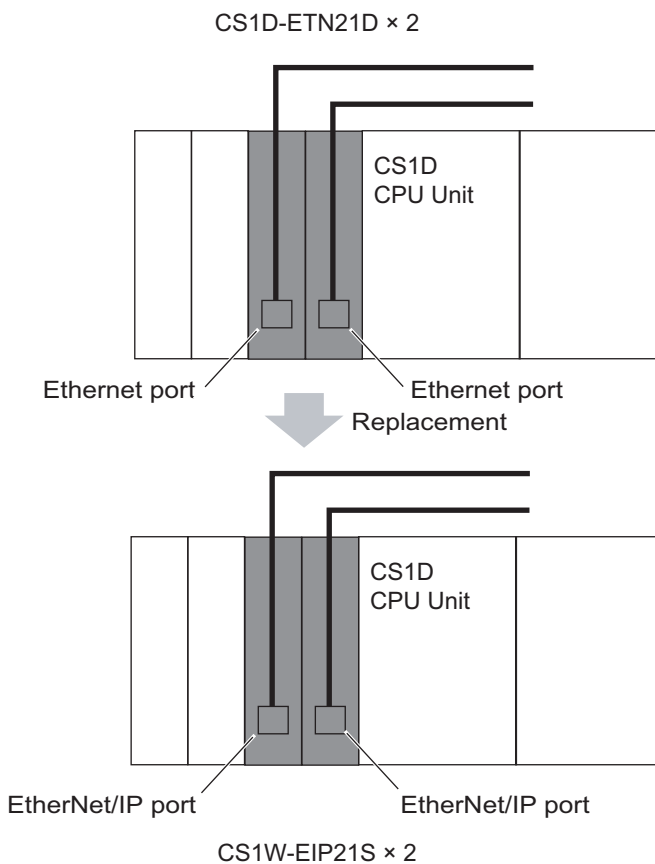

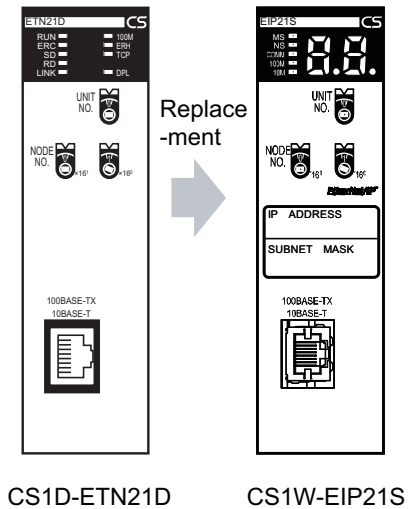

Refer to *1-3 Support Software* on page 1-13 for information on Support Software that supports the target replacement models.



Precautions for Correct Use

The CS1W-EIP21S does not support the duplex network function supported by the CS1D-ETN21D. To replace the CS1D-ETN21D that uses duplex network with the CS1W-EIP21S, you need to create a duplex network program.

Create the program so that the duplex system specifications before replacement are satisfied. After replacement, perform a thorough duplex system evaluation to check that the duplex system specifications are satisfied.

Refer to *Creating a Duplex Communications Program* on page 5-19 for creating a duplex network program. Refer to *A-1 Duplex Communications Sample Programming* on page A-2 for sample programming.

1-3 Support Software

The table below shows the version of the Support Software that supports the target replacement models and is used for replacement. If you have a CX-One version lower than 4.61, auto-update it in July 2023 or later. This allows you to update the version of the Support Software to the same state as what is included in the DVD of version 4.61.

Support Software	Supported version	Remarks
CX-One	4.61	<p>The CX-One provides an integrated package of Support Software for OMRON PLCs and components.</p> <p>It consists of software applications for PLC programming, network settings, touch-panel screen creation, servo control, inverters, temperature control, and other functions. The CX-Programmer version 9.81, Network Configurator for EtherNet/IP version 3.74a, and other software that you use to perform the replacement described in this guide are included in this package.</p>



Precautions for Correct Use

The following restrictions apply if you install the Support Software to a computer with an operating system earlier than Windows 10.

- You cannot install the EIP21S User Management Tool.
- You cannot select secure communications (Secure Comm) in the CX-Programmer and the PLC Backup Tool.

In addition, the following restrictions apply if you install the Support Software to a computer with the Windows 10 version earlier than 1803.

- You cannot go online with secure communications (Secure Comm).
- You cannot use user authentication and operation log that depend on secure communications.

To go online with secure communications (Secure Comm) and use functions that are dependent on secure communications, install the Support Software to a computer with the Windows 10 version 1803 or later.

2

Replacing a System with the CJ2 CPU Built-in EtherNet/IP Port

This section describes the replacement flow and replacement procedures for a system with the CJ2 CPU built-in EtherNet/IP port.

2-1	Differences in Specifications, Functions, Etc.	2-2
2-1-1	Differences in a System with the CJ2H-CPU6□-EIP	2-2
2-1-2	Differences in a System with the CJ2M-CPU3□	2-8
2-2	Replacement Flow	2-16
2-2-1	Flow of Preparation	2-16
2-2-2	Flow of Replacement.....	2-17
2-3	Preparation	2-19
2-3-1	Checking the Target Replacement Model	2-19
2-3-2	Checking the Differences in Specifications, Functions, Etc.	2-19
2-3-3	Getting the Support Software	2-19
2-3-4	Reading and Saving Data	2-19
2-3-5	Changing the PLC	2-26
2-3-6	Creating an I/O Table	2-28
2-3-7	Selecting the Power Supply Unit and Checking the Dimensions	2-32
2-3-8	Setting Up the CPU Unit.....	2-36
2-3-9	Setting Up the C□1W-EIP21S	2-38
2-3-10	Setting Up Other Units	2-40
2-3-11	Correcting PLC Memory	2-42
2-3-12	Correcting the User Program	2-44
2-3-13	Configuring Tag Data Links	2-44
2-4	Replacement	2-47
2-4-1	Replacing and Wiring Units	2-47
2-4-2	Turning ON the Power Supply.....	2-48
2-4-3	Transferring Data.....	2-49
2-4-4	Checking the Operation.....	2-55
2-4-5	Implementing Security Measures	2-55
2-4-6	Checking the Operation after Implementing Security Measures	2-58

2-1 Differences in Specifications, Functions, Etc.

This section describes the differences in specifications, functions, etc. between the source and target replacement models, and the restrictions that apply in a system with the CJ2 CPU built-in EtherNet/IP port. Check the differences in specifications, functions, etc. between the source and target replacement models, and the restrictions that apply, to determine the effects of replacement on the hardware, user program, and applications in the source replacement system.

Check the differences according to the table below.

Source replacement model	Target replacement model	Reference
CJ2H-CPU6□-EIP	CJ2H-CPU6□ + CJ1W-EIP21S	2-1-1 Differences in a System with the CJ2H-CPU6□-EIP on page 2-2
CJ2M-CPU3□	CJ2M-CPU1□ + CJ1W-EIP21S	2-1-2 Differences in a System with the CJ2M-CPU3□ on page 2-8

Note that the wildcard character “□” in the target replacement CPU Unit model indicates that the same number as that of the source replacement model is selected.

2-1-1 Differences in a System with the CJ2H-CPU6□-EIP

This section describes the differences in specifications, functions, etc. and the restrictions that apply when you replace the CJ2H-CPU6□-EIP with the CJ2H-CPU6□ and CJ1W-EIP21S. The following items are described.

Item	Reference
Differences in Unit Functions and Specifications	<i>Differences in Unit Functions and Specifications</i> on page 2-2
Differences in EtherNet/IP Port Memory Allocation	<i>Differences in EtherNet/IP Port Memory Allocation</i> on page 2-6
Restrictions	<i>Restrictions</i> on page 2-7

Differences in Unit Functions and Specifications

The tables below show functions and specifications that differ and the effects of the replacement.

● Hardware Specifications

Item	Source replacement model	Target replacement model	Effects of replacement
	CJ2H-CPU6□-EIP	CJ2H-CPU6□ + CJ1W-EIP21S	
Weight	280 g max.*1	281 g max.*1	The total weight after replacement is 281 g max., which is an increase of 1 g. Check if the increase will have any effect.

Item	Source replacement model	Target replacement model	Effects of replacement
	CJ2H-CPU6□-EIP	CJ2H-CPU6□ + CJ1W-EIP21S	
Current consumption	0.82 A at 5 VDC	1.07 A at 5 VDC	The total current consumption after replacement is 1.07 A at 5 VDC, which is an increase of 0.25 A. If the power supply is insufficient, you need to replace the Power Supply Unit, or change the system configuration to use an Expansion Rack. For details, refer to 2-3-7 <i>Selecting the Power Supply Unit and Checking the Dimensions</i> on page 2-32.

*1. This includes the weight of the End Cover and battery.

● Functions and Specifications of the CPU Unit

The differences between the source and target replacement CPU Unit models are shown below.

Item		Source replacement model	Target replacement model	Effects of replacement
		CJ2H-CPU6□-EIP	CJ2H-CPU6□ + CJ1W-EIP21S	
Type of symbol	Network symbols (tags)	Applicable	Unit version 1.6 or later: Applicable Unit version 1.5 or earlier: Not applicable	If network symbols are used in the source replacement model, use the CJ2H CPU Unit with unit version 1.6 or later.
Self-diagnostic and recovery	Non-fatal error detection: Tag memory error detection			
Number of connectable Units	CPU Bus Unit	15 max.	16 max.	There is no effect.
	Available location of interrupt	Slots 0 to 3 of CPU Rack	Slots 0 to 4 of CPU Rack	

● Functions and Specifications of the EtherNet/IP Port

The differences between the source replacement CPU built-in EtherNet/IP port and the target replacement CJ1W-EIP21S are shown below.

Item		Source replacement model	Target replacement model	Effects of replacement
		CJ2H-CPU6□-EIP	CJ2H-CPU6□ + CJ1W-EIP21S	
CPU Unit words used	Allocated CIO Area words (CPU Bus Unit words)	Socket service functions not available	Socket service functions available	There is no difference in the words used. However, socket service functions are added to reserved and unused bits for the source replacement model. For details on allocation and effects, refer to <i>Differences in EtherNet/IP Port Memory Allocation</i> on page 2-6.
	Allocated DM Area words (CPU Bus Unit words)			

Item		Source replacement model	Target replacement model	Effects of replacement
		CJ2H-CPU6□-EIP	CJ2H-CPU6□ + CJ1W-EIP21S	
Unit setup and tag data link settings storage for EtherNet/IP		Non-volatile memory in the built-in EtherNet/IP port	Non-volatile memory in the EtherNet/IP Unit	Reconfigure these settings for the CJ1W-EIP21S. For details, refer to 2-3-9 <i>Setting Up the C□1W-EIP21S</i> on page 2-38 and 2-3-13 <i>Configuring Tag Data Links</i> on page 2-44.
CIP communications service: Tag data links (cyclic communications)	Allowed communications bandwidth per Unit	<ul style="list-style-type: none"> 12,000 pps (Built-in EtherNet/IP port with unit version 3.0 or later) 6,000 pps (Built-in EtherNet/IP port with unit version 2.1 or earlier) 	12,000 pps	There is no effect.
	Data that can be refreshed per CPU Unit cycle	Output/Transmission (CPU to EtherNet/IP): 6,432 words Input/Reception (EtherNet/IP to CPU): 6,432 words (6,368 words for both input and output when User defined is set for the layout of the allocated CIO Area words)	Output/Transmission (CPU to EtherNet/IP): 6,432 words Input/Reception (EtherNet/IP to CPU): 6,432 words (6,172 words for output and 6,236 words for input when User defined is set for the layout of the allocated CIO Area words)	The data size will decrease when User defined is set for the layout of the allocated CIO Area words. If the maximum data size is exceeded, refreshing the data in the CPU Unit will span multiple cycles. Check the effects on communications performance.
FINS communications service	Type of supported FINS commands	Socket service commands not available	Socket service commands available	There is no effect.
	Setting and default for using or not using FINS/UDP service	<ul style="list-style-type: none"> Setting function: Not available Default: Use FINS/UDP service 	<ul style="list-style-type: none"> Setting function: Available Default: Not use FINS/UDP service 	To use the FINS function, you need to set Use FINS/UDP service . Refer to 2-3-9 <i>Setting Up the C□1W-EIP21S</i> on page 2-38 for details.
	Setting and default for using or not using FINS/TCP service	<ul style="list-style-type: none"> Setting function: Not available Default: Use FINS/TCP service 	<ul style="list-style-type: none"> Setting function: Available Default: Not use FINS/TCP service 	To use the FINS function, you need to set Use FINS/TCP service . Refer to 2-3-9 <i>Setting Up the C□1W-EIP21S</i> on page 2-38 for details.
	Keep-alive setting	Fixed to 5 min when the keep-alive function is in effect.	Can be set in the TCP/IP Tab Page. The default is 5 min.	There is no effect.
FTP server		Available (Built-in EtherNet/IP port with unit version 2.0 or later)	Available	There is no effect.
Default for using or not using FTP		Default: Use FTP	Default: Not Use FTP	To use the FTP function, you need to set Use FTP . Refer to 2-3-9 <i>Setting Up the C□1W-EIP21S</i> on page 2-38 for details.

Item		Source replacement model	Target replacement model	Effects of replacement
		CJ2H-CPU6□-EIP	CJ2H-CPU6□ + CJ1W-EIP21S	
	User name/ password	<ul style="list-style-type: none"> User name (1 to 12 characters) Default: CONFIDENTIAL Password (1 to 8 characters) Default: - (Not set) Entered characters displayed 	<ul style="list-style-type: none"> User name (1 to 16 characters) Default: - (Not set) Password (8 to 16 characters) Default: - (Not set) Entered characters replaced by asterisks 	To use the FTP function, you need to set the user name (login name) and password again. Refer to 2-3-9 <i>Setting Up the C□1W-EIP21S</i> on page 2-38 for details.
Automatic clock adjustment		Available (Built-in EtherNet/IP port with unit version 2.0 or later)	Available	There is no effect.
BOOTP client	Get the IP address from the BOOTP server at each power ON or restart	Not available	Available	There is no effect.
Simple backup function	Backup data capacity of EtherNet/IP port	459 KB	364 KB	There is no effect.
SNMP/SNMP trap		Available (Built-in EtherNet/IP port with unit version 2.0 or later) Community name: Entered characters displayed	Available Community name: Entered characters replaced by asterisks	There is no effect.
CIDR function for IP addresses		Available (Built-in EtherNet/IP port with unit version 2.0 or later)	Available	There is no effect.
Setting for using or not using CIP message server		<ul style="list-style-type: none"> Setting function: Not available Default: Use 	<ul style="list-style-type: none"> Setting function: Available Default: Use 	There is no effect.

Item		Source replacement model	Target replacement model	Effects of replacement
		CJ2H-CPU6□-EIP	CJ2H-CPU6□ + CJ1W-EIP21S	
Security	Secure communications	Not available	Available	After replacement, we recommend using these functions to reduce security risks. Refer to <i>2-4-5 Implementing Security Measures</i> on page 2-55 for details.
	User authentication			
	IP packet filtering			
	Opening and closing the port*1	Without opening and closing the port for the following services. <ul style="list-style-type: none"> FINS/UDP service FINS/TCP service CIP message server 	With opening and closing the port for the following services. <ul style="list-style-type: none"> FINS/UDP service FINS/TCP service CIP message server 	Before replacement, you need to configure the port for the service in use. Refer to <i>2-3-9 Setting Up the C□1W-EIP21S</i> on page 2-38 for details.
	Operation log	Not available	Available	There is no effect.
Socket services		Not available	Available	There is no effect in this replacement case.
Online connection from CX-One to CPU Unit via EtherNet/IP port with secure communications		Not available	Available	After replacement, we recommend using these functions to reduce security risks. Refer to <i>2-4-5 Implementing Security Measures</i> on page 2-55 for details.
Online connection by EtherNet/IP using CX-One		Available	Available	After replacement, we do not recommend using this connection method to reduce security risks.
Online connection by Ethernet (FINS) using CX-One		Available	Available	After replacement, we do not recommend using this connection method to reduce security risks. To connect online with Ethernet network type setting, set the Unit to use FINS/UDP service. To connect online with Ethernet (FINS/TCP) network type setting, set the Unit to use FINS/TCP service.

- *1. Both the source and target replacement models support opening and closing the port for the following services.
- FTP server and SNMP

Differences in EtherNet/IP Port Memory Allocation

The table below shows functions that differ in memory allocation between the CJ2 CPU built-in EtherNet/IP port (CJ2H-CPU6□-EIP or CJ2M-CPU3□) and the CJ1W-EIP21S. Refer to the *CS/CJ-series EtherNet/IP Units Operation Manual (Cat. No. W465)* for details on functions that differ.

Item	Source replacement model	Target replacement model	Effects of replacement
	CJ2 CPU built-in EtherNet/IP port (CJ2H-CPU6□-EIP, CJ2M-CPU3□)	CJ1W-EIP21S	

Allocated CIO Area words (CPU Bus Unit words)

User settings area	n+1 to n+4	Reserved	Socket Service Request Switches (CPU Unit to EtherNet/IP Unit)	When User defined is set for the layout of the allocated CIO Area words, socket service functions are added to the reserved area words of the source replacement model. Make sure that the reserved area words are not manipulated by the user program.
	n+16 to n+23	Reserved	UDP Socket No. □ Status and TCP Socket No. □ Status (EtherNet/IP Unit to CPU Unit)	
Unit Control Bits (CPU Unit to EtherNet/IP Unit) (n)	Bit 10	Reserved	Socket Force-close Switch (CPU Unit to EtherNet/IP Unit)	Socket service functions are added to the target replacement models. Make sure that the reserved bits are not manipulated by the user program.
Unit Status 2 (EtherNet/IP Unit to CPU Unit) (n + 11)	Bit 10	Not used	User Authentication Setting Error (EtherNet/IP Unit to CPU Unit)	Functions are added to the target replacement models. Check the effects on the user program before replacement. Also, after replacement, change the program to monitor this bit.
	Bit 12 and Bit 13	Not used	Reserved	Functions are added to the target replacement models. Check the effects on the user program before replacement.

Allocated DM Area words (CPU Bus Unit words)

m+1 to m+8	Not used	Number of Bytes Received at TCP Socket No. □ (EtherNet/IP Unit to CPU Unit)	Socket service functions are added to the target replacement models. If the area words are used by the user program, the meaning of the data will change. Consider changing the data that was used before replacement to other available DM Area words.
m+9 to m+16	Not used	TCP Socket No. □ Connection Status (EtherNet/IP Unit to CPU Unit)	
m+17 to m+96	Not used	Socket Service Parameter Area □ (EtherNet/IP Unit to CPU Unit or CPU Unit to EtherNet/IP Unit)	

Restrictions

The table below shows restrictions on replacement.

Item	Description	Effects of replacement
Backup/ restoration	The CJ1W-EIP21S has more data to back up than the CJ2H-CPU6□-EIP and CJ1W-EIP21 due to the addition of security functions. It also has the same settings but different default values from those of the CJ2H-CPU6□-EIP and CJ1W-EIP21.	You cannot restore the backup data from the CJ2H-CPU6□-EIP to the CJ1W-EIP21S if the simple backup function or PLC Backup Tool is used for backup. To do so, you need to use the CX-Programmer to reconfigure it to have the same settings as the source replacement model.
Power OFF detection time	Replacing the source replacement model with the CJ1W-EIP21S may not allow you to set the power OFF detection time depending on the model of the Power Supply Unit in use.	If you need to set the power OFF detection time, replace the Power Supply Unit. For details, refer to <i>2-3-7 Selecting the Power Supply Unit and Checking the Dimensions</i> on page 2-32.
Use restriction on the Power Supply Unit	The CJ1W-EIP21S cannot be used with the CJ1W-PD022 Power Supply Unit.	If you use the Power Supply Unit mentioned on the left, change it to a different Power Supply Unit. For details, refer to <i>2-3-7 Selecting the Power Supply Unit and Checking the Dimensions</i> on page 2-32.
Unit startup time	The startup time of the CJ1W-EIP21S is longer than that of the CJ2H-CPU6□-EIP or CJ1W-EIP21. For this reason, the CPU Unit startup time will be delayed by a few seconds compared with the system before replacement.	This means that you need to check the effects on the startup operation of the system.

2-1-2 Differences in a System with the CJ2M-CPU3□

This section describes the differences in specifications, functions, etc. and the restrictions that apply when you replace the CJ2M-CPU3□ with the CJ2M-CPU1□ and CJ1W-EIP21S. The following items are described.

Item	Reference
Differences in Unit Functions and Specifications	<i>Differences in Unit Functions and Specifications</i> on page 2-8
Differences in EtherNet/IP Port Memory Allocation	<i>Differences in EtherNet/IP Port Memory Allocation</i> on page 2-14
Restrictions	<i>Restrictions</i> on page 2-15

Differences in Unit Functions and Specifications

The tables below show functions and specifications that differ and the effects of the replacement.

● Hardware Specifications

Item	Source replacement model	Target replacement model	Effects of replacement
	CJ2M-CPU3□	CJ2M-CPU1□ + CJ1W-EIP21S	
Weight	190 g max.*1*2	221 g max.*1	The total weight after replacement is 221 g max., which is an increase of 31 g. Check if the increase will have any effect.

Item	Source replacement model	Target replacement model	Effects of replacement
	CJ2M-CPU3□	CJ2M-CPU1□ + CJ1W-EIP21S	
Current consumption	0.70 A at 5 VDC	1.15 A at 5 VDC	The total current consumption after replacement is 1.15 A at 5 VDC, which is an increase of 0.45 A. If the power supply is insufficient, you need to replace the Power Supply Unit, or change the system configuration to use an Expansion Rack. For details, refer to 2-3-7 <i>Selecting the Power Supply Unit and Checking the Dimensions</i> on page 2-32.

*1. This includes the weight of the End Cover and battery.

*2. The Serial Option Board is not included.

● Functions and Specifications of the CPU Unit

The differences between the source and target replacement CPU Unit models are shown below.

Item		Source replacement model	Target replacement model	Effects of replacement
		CJ2M-CPU3□	CJ2M-CPU1□ + CJ1W-EIP21S	
Type of symbol	Network symbols (tags)	Applicable	Unit version 2.2 or later: Applicable Unit version 2.1 or earlier: Not applicable	If network symbols are used in the source replacement model, use the CJ2M CPU Unit with unit version 2.2 or later.
Self-diagnostic and recovery	Non-fatal error detection: Tag memory error detection			
	Option Board error detection	Available	Not available	You need to correct the user program if it monitors error flags.
Number of connectable Units	CPU Bus Unit	15 max.	16 max.	There is no effect.
Communications	Serial port	No serial port by default The following Serial Option Boards can be added. <ul style="list-style-type: none"> RS-232C Option Board: CP1W-CIF01 RS-422A/485 Option Board: CP1W-CIF11 (Non-isolated type, maximum transmission distance of 50 m) RS-422A/485 Option Board: CP1W-CIF12 (Isolated type, maximum transmission distance of 500 m) 	Serial port available. Conforming to EIA RS-232C	If a Serial Option Board is used with the source replacement model, a configuration change is required. For details, refer to <i>Replacement When a Serial Option Board Is Used</i> on page 1-7 in 1-2-1 <i>System with the CJ2 CPU Built-in EtherNet/IP Port</i> on page 1-3.

● Functions and Specifications of the EtherNet/IP Port

The differences between the source replacement CPU built-in EtherNet/IP port and the target replacement CJ1W-EIP21S are shown below.

Item		Source replacement model	Target replacement model	Effects of replacement
		CJ2M-CPU3□	CJ2M-CPU1□ + CJ1W-EIP21S	
CPU Unit words used	Allocated CIO Area words (CPU Bus Unit words)	Socket service functions not available	Socket service functions available	There is no difference in the words used. However, socket service functions are added to reserved and unused bits for the source replacement model. For details on allocation and effects, refer to <i>Differences in EtherNet/IP Port Memory Allocation</i> on page 2-6.
	Allocated DM Area words (CPU Bus Unit words)			
Unit setup and tag data link settings storage for EtherNet/IP		Non-volatile memory in the built-in EtherNet/IP port	Non-volatile memory in the EtherNet/IP Unit	Reconfigure these settings for the CJ1W-EIP21S. For details, refer to 2-3-9 <i>Setting Up the C□1W-EIP21S</i> on page 2-38 and 2-3-13 <i>Configuring Tag Data Links</i> on page 2-44.

Item		Source replacement model	Target replacement model	Effects of replacement
		CJ2M-CPU3□	CJ2M-CPU1□ + CJ1W-EIP21S	
CIP communications service: Tag data links (cyclic communications)	Number of connections	32	256	There is no effect.
	Packet interval (refresh cycle)	1 to 10,000 ms (in 0.5-ms units) Can be set independently for each connection. (Data is refreshed over the network at the preset interval and does not depend on the number of nodes.)	0.5 to 10,000 ms (in 0.5-ms units) Can be set independently for each connection. (Data is refreshed over the network at the preset interval and does not depend on the number of nodes.)	
	Allowed communications bandwidth per Unit	3,000 pps	12,000 pps	
	Number of registrable tags	32	256	
	Maximum link data size per node	640 words	184,832 words	
	Maximum data size per connection	252 or 640 words*1 (Data synchronicity is maintained within each connection.)	252 or 722 words (Data synchronicity is maintained within each connection.)	
	Number of registrable tag sets	32 (1 connection = 1 tag set)	256 (1 connection = 1 tag set)	
	Maximum size of 1 tag set	640 words*1 (The PLC status uses 1 word when the tag set contains the PLC status.)	722 words (The PLC status uses 1 word when the tag set contains the PLC status.)	
	Maximum number of tags that can be refreshed per CPU Unit cycle	Output/Transmission (CPU to EtherNet/IP): 32 Input/Reception (EtherNet/IP to CPU): 32	Output/Transmission (CPU to EtherNet/IP): 256 Input/Reception (EtherNet/IP to CPU): 256	

Item	Source replacement model	Target replacement model	Effects of replacement	
	CJ2M-CPU3□	CJ2M-CPU1□ + CJ1W-EIP21S		
	Data that can be refreshed per CPU Unit cycle	Output/Transmission (CPU to EtherNet/IP): 640 words Input/Reception (EtherNet/IP to CPU): 640 words	Output/Transmission (CPU to EtherNet/IP): 6,432 words Input/Reception (EtherNet/IP to CPU): 6,432 words (6,172 words for output and 6,236 words for input when User defined is set for the layout of the allocated CIO Area words)	There will be more data that the CPU Unit can exchange with the CJ1W-EIP21S per cycle. Depending on the data size used, communications performance will be improved due to decrease in the number of data exchange cycles. Check the effects on system performance.
CIP communications service: Explicit messages (message communications)	UCMM (un-connected)	Number of clients that can communicate at one time: 16 max. Number of servers that can communicate at one time: 16 max.	Number of clients that can communicate at one time: 32 max. Number of servers that can communicate at one time: 32 max.	There is no effect.
FINS communications service	Type of supported FINS commands	Socket service commands not available	Socket service commands available	There is no effect.
	Setting and default for using or not using FINS/UDP service	<ul style="list-style-type: none"> Setting function: Not available Default: Use FINS/UDP service 	<ul style="list-style-type: none"> Setting function: Available Default: Not use FINS/UDP service 	To use the FINS function, you need to set Use FINS/UDP service . Refer to 2-3-9 <i>Setting Up the C□1W-EIP21S</i> on page 2-38 for details.
	Setting and default for using or not using FINS/TCP service	<ul style="list-style-type: none"> Setting function: Not available Default: Use FINS/TCP service 	<ul style="list-style-type: none"> Setting function: Available Default: Not use FINS/TCP service 	To use the FINS function, you need to set Use FINS/TCP service . Refer to 2-3-9 <i>Setting Up the C□1W-EIP21S</i> on page 2-38 for details.
	Keep-alive setting	Fixed to 5 min when the keep-alive function is in effect.	Can be set in the TCP/IP Tab Page. The default is 5 min.	There is no effect.
FTP server		Available (Built-in EtherNet/IP port with unit version 2.0 or later)	Available	There is no effect.
	Default for using or not using FTP	Default: Use FTP	Default: Not Use FTP	To use the FTP function, you need to set Use FTP . Refer to 2-3-9 <i>Setting Up the C□1W-EIP21S</i> on page 2-38 for details.

Item		Source replacement model	Target replacement model	Effects of replacement
		CJ2M-CPU3□	CJ2M-CPU1□ + CJ1W-EIP21S	
	User name/ password	<ul style="list-style-type: none"> User name (1 to 12 characters) Default: CONFIDENTIAL Password (1 to 8 characters) Default: - (Not set) Entered characters displayed 	<ul style="list-style-type: none"> User name (1 to 16 characters) Default: - (Not set) Password (8 to 16 characters) Default: - (Not set) Entered characters replaced by asterisks 	To use the FTP function, you need to set the user name (login name) and password again. Refer to 2-3-9 <i>Setting Up the C□1W-EIP21S</i> on page 2-38 for details.
Automatic clock adjustment		Available (Built-in EtherNet/IP port with unit version 2.0 or later)	Available	There is no effect.
BOOTP client	Get the IP address from the BOOTP server at each power ON or restart	Not available	Available	There is no effect.
Simple backup function	Backup data capacity of EtherNet/IP port	459 KB	364 KB	There is no effect.
SNMP/SNMP trap		Available (Built-in EtherNet/IP port with unit version 2.0 or later) Community name: Entered characters displayed	Available Community name: Entered characters replaced by asterisks	There is no effect.
CIDR function for IP addresses		Available (Built-in EtherNet/IP port with unit version 2.0 or later)	Available	There is no effect.
Setting for using or not using CIP message server		<ul style="list-style-type: none"> Setting function: Not available Default: Use 	<ul style="list-style-type: none"> Setting function: Available Default: Use 	There is no effect.

Item		Source replacement model	Target replacement model	Effects of replacement
		CJ2M-CPU3□	CJ2M-CPU1□ + CJ1W-EIP21S	
Security	Secure communications	Not available	Available	After replacement, we recommend using these functions to reduce security risks. Refer to <i>2-4-5 Implementing Security Measures</i> on page 2-55 for details.
	User authentication			
	IP packet filtering			
	Opening and closing the port*2	Without opening and closing the port for the following services. <ul style="list-style-type: none"> • FINS/UDP service • FINS/TCP service • CIP message server 	With opening and closing the port for the following services. <ul style="list-style-type: none"> • FINS/UDP service • FINS/TCP service • CIP message server 	Before replacement, you need to configure the port for the service in use. Refer to <i>2-3-9 Setting Up the C□1W-EIP21S</i> on page 2-38 for details.
	Operation log	Not available	Available	There is no effect.
Socket services		Not available	Available	There is no effect in this replacement case.
Online connection from CX-One to CPU Unit via EtherNet/IP port with secure communications		Not available	Available	After replacement, we recommend using these functions to reduce security risks. Refer to <i>2-4-5 Implementing Security Measures</i> on page 2-55 for details.
Online connection by EtherNet/IP using CX-One		Available	Available	After replacement, we do not recommend using this connection method to reduce security risks.
Online connection by Ethernet (FINS) using CX-One		Available	Available	After replacement, we do not recommend using this connection method to reduce security risks. To connect online with Ethernet network type setting, set the Unit to use FINS/UDP service. To connect online with Ethernet (FINS/TCP) network type setting, set the Unit to use FINS/TCP service.

*1. The maximum size is 20 words for the built-in EtherNet/IP port with unit version 2.0.

*2. Both the source and target replacement models support opening and closing the port for the following services.

- FTP server and SNMP

Differences in EtherNet/IP Port Memory Allocation

Functions that differ in memory allocation between the CJ2M-CPU3□ and CJ1W-EIP21S are the same as those between the CJ2H-CPU6□-EIP and CJ1W-EIP21S. For these differences, refer to *Differences in EtherNet/IP Port Memory Allocation* on page 2-6 in *2-1-1 Differences in a System with the CJ2H-CPU6□-EIP* on page 2-2.

Restrictions

The table below shows restrictions on replacement.

Item	Description	Effects of replacement
Backup/restoration	The CJ1W-EIP21S has more data to back up than the CJ2M-CPU3□ and CJ1W-EIP21 due to the addition of security functions. It also has the same settings but different default values from those of the CJ2M-CPU3□ and CJ1W-EIP21.	You cannot restore the backup data from the CJ2M-CPU3□ to the CJ1W-EIP21S if the simple backup function or PLC Backup Tool is used for backup. To do so, you need to use the CX-Programmer to reconfigure it to have the same settings as the source replacement model.
Power OFF detection time	Replacing the source replacement model with the CJ1W-EIP21S may not allow you to set the power OFF detection time depending on the model of the Power Supply Unit in use.	If you need to set the power OFF detection time, replace the Power Supply Unit. For details, refer to <i>2-3-7 Selecting the Power Supply Unit and Checking the Dimensions</i> on page 2-32.
Use restriction on the Power Supply Unit	The CJ1W-EIP21S cannot be used with the CJ1W-PD022 Power Supply Unit.	If you use the Power Supply Unit mentioned on the left, change it to a different Power Supply Unit. For details, refer to <i>2-3-7 Selecting the Power Supply Unit and Checking the Dimensions</i> on page 2-32.
Unit startup time	The startup time of the CJ1W-EIP21S is longer than that of the CJ2M-CPU3□ or CJ1W-EIP21. For this reason, the CPU Unit startup time will be delayed by a few seconds compared with the system before replacement.	This means that you need to check the effects on the startup operation of the system.

2-2 Replacement Flow

This section describes the flow of replacing a system with the CJ2 CPU built-in EtherNet/IP port. It consists of the flow of preparation and the flow of replacement.

2-2-1 Flow of Preparation

The table below shows the contents of preparation that you should make before replacement. Use this flow to plan a replacement and prepare data that matches the Unit configuration after replacement. Make the target replacement Unit available before replacement.

Step	Item	Description	Reference
1	Checking the Target Replacement Model	Check the target replacement model against the system configuration of the source replacement model. Check also the Support Software that supports the target replacement model.	2-3-1 <i>Checking the Target Replacement Model</i> on page 2-19
2	Checking the Differences in Specifications, Functions, Etc.	Check the differences in specifications, functions, etc. between the source and target replacement models, and the restrictions that apply, to determine the effects of replacement on the hardware, user program, and applications in the source replacement system.	2-3-2 <i>Checking the Differences in Specifications, Functions, Etc.</i> on page 2-19
3	Getting the Support Software	Get the Support Software that you will use for preparation and replacement.	2-3-3 <i>Getting the Support Software</i> on page 2-19
4	Reading and Saving Data	Read and save the following data from the source replacement system. You will use the data read in this step, and edit or set it in subsequent steps to match the target replacement system. <ul style="list-style-type: none"> • PLC project data • Tag data link parameters • Routing table • Set data for Units that use the CPU Bus Unit Setup Area 	2-3-4 <i>Reading and Saving Data</i> on page 2-19
5	Changing the PLC	Since this step involves replacing the CPU Unit, edit the read PLC project data for the target replacement CPU Unit. If a program error occurs as a result of editing, correct it. Note also that other project data may be initialized due to an edit. If data is initialized, correct it in subsequent steps.	2-3-5 <i>Changing the PLC</i> on page 2-26
6	Creating an I/O Table	Create an I/O table to match the Unit configuration after replacement.	2-3-6 <i>Creating an I/O Table</i> on page 2-28
7	Selecting the Power Supply Unit and Checking the Dimensions	Check if it is necessary to change the Power Supply Unit in order to deal with the restrictions on the power supply that arise due to the replacement. If necessary, select an adequate Power Supply Unit. If, after the selection, you change the Power Supply Unit or expand the system, check the difference in the dimensions of the Unit configuration before and after replacement.	2-3-7 <i>Selecting the Power Supply Unit and Checking the Dimensions</i> on page 2-32

Step	Item	Description	Reference
8	Setting Up the CPU Unit	Set up the CPU Unit in the Unit configuration after replacement.	2-3-8 <i>Setting Up the CPU Unit</i> on page 2-36
9	Setting Up the C□1W-EIP21S	Set up the C□1W-EIP21S in the Unit configuration after replacement.	2-3-9 <i>Setting Up the C□1W-EIP21S</i> on page 2-38
10	Setting Up Other Units	Set up Units other than the CPU Unit and C□1W-EIP21S in the Unit configuration after replacement.	2-3-10 <i>Setting Up Other Units</i> on page 2-40
11	Correcting PLC Memory	If PLC memory is initialized by changing the PLC model, correct the data.	2-3-11 <i>Correcting PLC Memory</i> on page 2-42
12	Editing the User Program	Edit the user program to deal with the differences in specifications due to the replacement and the restrictions that apply.	2-3-12 <i>Correcting the User Program</i> on page 2-44
13	Configuring Tag Data Links	Configure tag data links to match the Unit configuration after replacement.	2-3-13 <i>Configuring Tag Data Links</i> on page 2-44

2-2-2 Flow of Replacement

The table below shows the actual replacement steps that you should follow on completion of the preparation steps. You can implement security measures as needed after replacement.

Step	Item	Description	Reference
14	Replacing and Wiring Units	Replace Units according to the Unit configuration after replacement. Then, wire the replaced Units.	2-4-1 <i>Replacing and Wiring Units</i> on page 2-47
15	Turning ON the Power Supply	Turn ON the power supply to the PLC.	2-4-2 <i>Turning ON the Power Supply</i> on page 2-48
16	Transferring Data	From the Support Software connected directly to the CPU Unit, transfer the following data that you prepared to the actual PLC after replacement.*1 <ul style="list-style-type: none"> • PLC project data • Tag data link parameters • Routing table • Set data for Units that use the CPU Bus Unit Setup Area 	2-4-3 <i>Transferring Data</i> on page 2-49
17	Checking the Operation	Confirm that the system operates as intended.	2-4-4 <i>Checking the Operation</i> on page 2-55
18	Implementing Security Measures*2	If necessary, implement measures to reduce the security risks from external attacks before the start of system operation after replacement. We recommend that you set user authentication and use secure communications (Secure Comm) to connect the Support Software online to the CJ1W-EIP21S EtherNet/IP port. In addition to user authentication and secure communications (Secure Comm), the CJ1W-EIP21S and Support Software provide other security functions to reduce security risks. Use these security functions in conjunction with system operation to further reduce the security risks.	2-4-5 <i>Implementing Security Measures</i> on page 2-55

Step	Item	Description	Reference
19	Checking the Operation after Implementing Security Measures	After you implement security measures, check to be sure that the system operates according to the security settings.	<i>2-4-6 Checking the Operation after Implementing Security Measures</i> on page 2-58

*1. This means to connect Support Software directly to the USB port or peripheral port on the CPU Unit.

*2. Do this as needed.

2-3 Preparation

This section describes the preparation steps that you should follow before replacement.

2-3-1 Checking the Target Replacement Model

Check the target replacement model against the system configuration of the source replacement model. Check also the Support Software that supports the target replacement model.

For details, refer to *1-2-1 System with the CJ2 CPU Built-in EtherNet/IP Port* on page 1-3.

2-3-2 Checking the Differences in Specifications, Functions, Etc.

Check the differences in specifications, functions, etc. between the source and target replacement models, and the restrictions that apply, to determine the effects of replacement on the hardware, user program, and applications in the source replacement system.

For details, refer to *2-1 Differences in Specifications, Functions, Etc.* on page 2-2.

2-3-3 Getting the Support Software

Get the Support Software that you will use for preparation and replacement. Specifically, get the CX-One version shown in *1-3 Support Software* on page 1-13 or higher.

All Support Software applications that you will use in the following sections are packaged in the CX-One.

2-3-4 Reading and Saving Data

Read and save the following data from the source replacement system.

You will use the data read in this step, and edit or set it in subsequent steps to match the target replacement system.

Data	Description	Reference
PLC project data*1	This data includes the user program, PLC settings, I/O table, Special Unit settings, and PLC memory. Use the CX-Programmer to read and save it.	<i>Reading PLC Project Data (from PLC)</i> on page 2-20
Tag data link parameters	This data is available only when you use tag data links. Use the Network Configurator to upload and save it.	<i>Uploading Tag Data Link Parameters</i> on page 2-23
Routing table	This data is available only when you set a routing table. Use the CX-Integrator to read and save it.	<i>Reading the Routing Table (from PLC)</i> on page 2-23
Set data for Units that use the CPU Bus Unit Setup Area	This data is available only when you use Units that use the CPU Bus Unit Setup Area. An example of this is data link tables of CLK Units. The method to read and save data depends on the Unit.	<i>Reading the Settings of Units That Use the CPU Bus Unit Setup Area</i> on page 2-26

*1. This data is stored in the CX-Programmer project file. In this manual, it is referred to as PLC project data.

Perform this operation so that you can restore the data from the source replacement system. Even when you have the data in the source replacement system, there is a risk of trouble if it is different from the data in the actual PLC. We recommend that you read and save it.



Precautions for Correct Use

You cannot restore the backup data from the CJ2H-CPU6□-EIP, CJ2M-CPU3□, or CJ1W-EIP21 to the CJ1W-EIP21S if the simple backup function or PLC Backup Tool is used for backup. Also, you cannot restore data to the CS1W-EIP21S if it was backed up with the CS1W-EIP21.

Details on each of the above data are given below.

Reading PLC Project Data (from PLC)

Use the CX-Programmer to read and save the following project data from the source replacement PLC.

- User program
- PLC settings
- I/O table
- Special Unit settings
- PLC memory (i.e., data in the DM, EM, HR, and other areas that is retained even when the power supply is turned OFF)

This data is stored in the CPU Unit. Therefore, to replace the CPU Unit, you need to move the data.



Additional Information

Some CPU Bus Units store the Special Unit settings in them.

● Reading and Saving PLC Project Data

Use the CX-Programmer to read and save project data from the PLC as described below.

Refer to the *CX-Programmer Ver. 9.□ Operation Manual (Cat. No. W446)* in addition to this manual for how to operate the CX-Programmer and connect the CPU Unit to the CX-Programmer. Refer also to the user's manual for your CPU Unit for how to connect the CPU Unit to the CX-Programmer.

- 1** Connect the CPU Unit and the computer with a Support Software connection cable, etc.
- 2** Start the CX-Programmer.
- 3** Use one of the following methods to connect online to the PLC to read from.
 - Automatic online connection
 - Connection based on the PLC model, network type, and network settings
- 4** Change the CPU Unit to PROGRAM mode.
PLC – Operating Mode – Program
- 5** Read the PLC project data except for PLC memory.
PLC – Transfer – From PLC

(1) Select all the check boxes, such as Settings, IO table, Special Unit Setup.

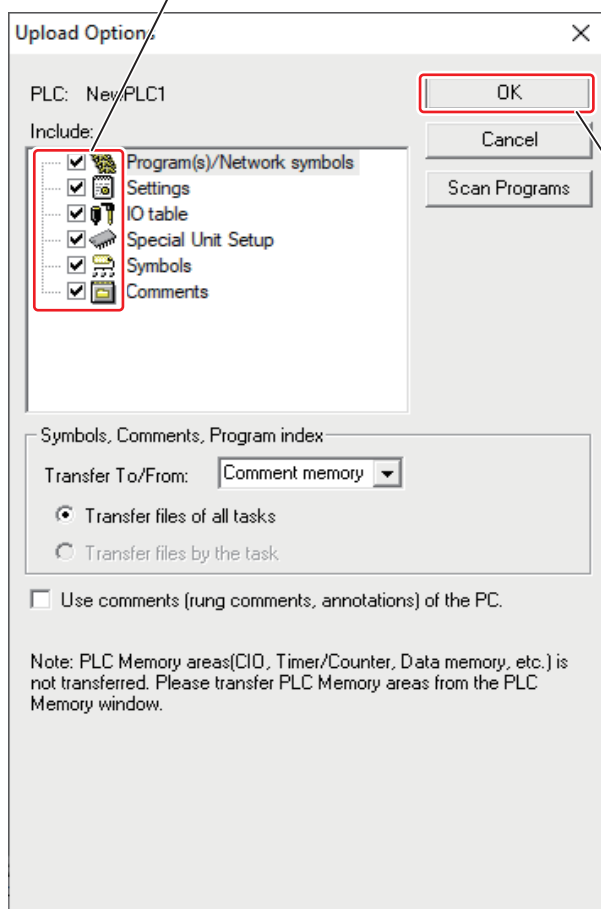

(2) Click the **OK** Button.

Clicking the **OK** Button displays a series of confirmation dialog boxes. Click the **Yes** or **OK** Buttons in all of the dialog boxes.

This transfers the PLC project data except for PLC memory to the computer.

- 6** Read PLC memory. This is an example of reading data from the DM Area.
PLC – Edit – Memory

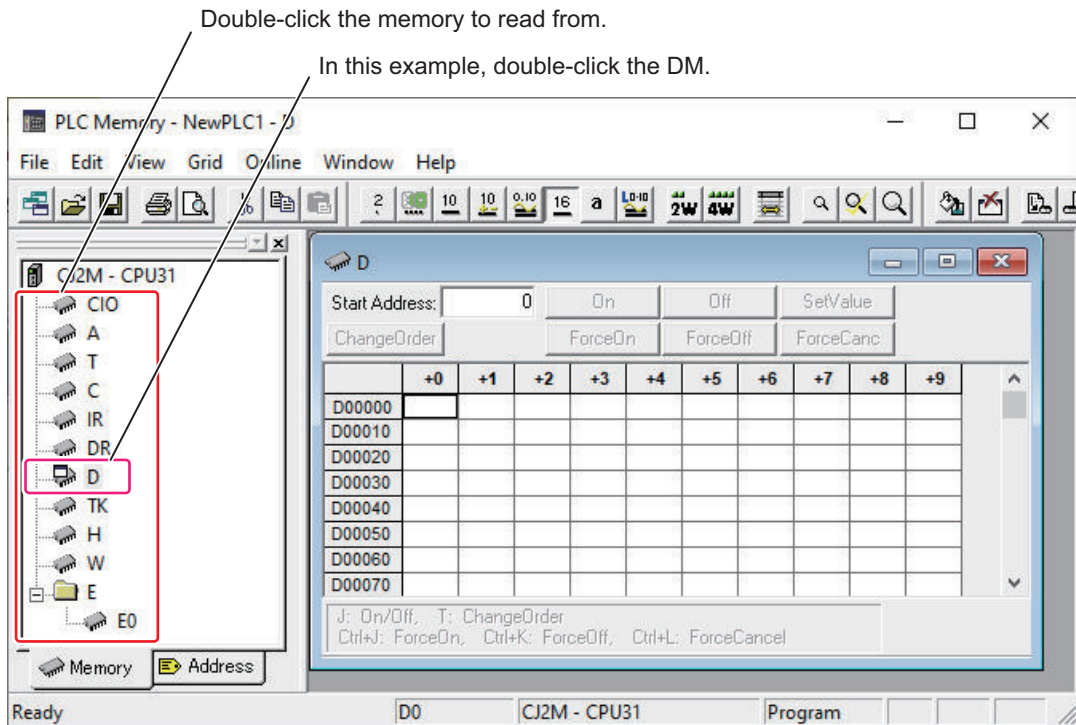

Online – Transfer From PLC

Click the **Transfer From PLC** Button.

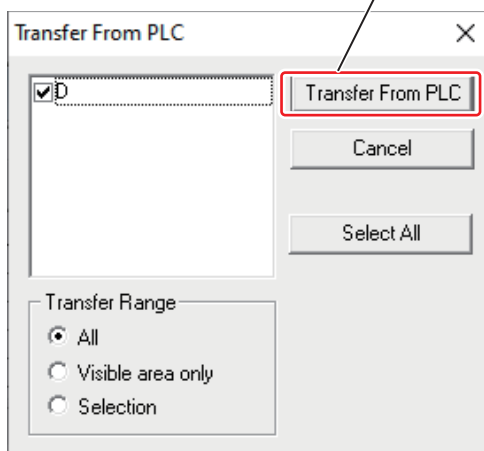

This transfers data from the PLC’s data memory (DM) to the computer. In the same way, read data in the EM, HR, and other areas except for DM that is retained even when the power supply is turned OFF. Refer to *I/O Memory Areas* in the CPU Unit’s user’s manual for data that is retained even when the power supply is turned OFF.

7 Save the PLC project data to the computer.

Place the CX-Programmer offline.

PLC – Work Online

Name and save the project data to the computer as a file.

File – Save As

Uploading Tag Data Link Parameters

If tag data links are used in the source replacement model, upload and save tag data link parameters from the EtherNet/IP Unit or built-in EtherNet/IP port. To do so, use the Network Configurator to access the EtherNet/IP Unit or built-in EtherNet/IP port in the EtherNet/IP network.

The tag data link parameters are information such as tag set information and connection information. This data is stored in the EtherNet/IP Unit or built-in EtherNet/IP port. Therefore, to replace the EtherNet/IP Unit or built-in EtherNet/IP port, you need to move the data.

Refer to the table below for details on the operating procedures.

Item	Reference
Reading tag data link parameters from the EtherNet/IP Unit or built-in EtherNet/IP port	<i>Uploading Tag Data Link Parameters</i> in the <i>CS/CJ-series EtherNet/IP Units Operation Manual (Cat. No. W465)</i>
Saving the read tag data link parameters	<i>Saving the Network Configuration File</i> in the <i>CS/CJ-series EtherNet/IP Units Operation Manual (Cat. No. W465)</i>

Reading the Routing Table (from PLC)

When a routing table is set in the source replacement model, use the CX-Integrator to read and save it from the PLC.

This data is stored in the CPU Unit. Therefore, to replace the CPU Unit, you need to move the data.

● Reading and Saving the Routing Table

Use the CX-Integrator to read and save the routing the table from the PLC as described below. Refer to the *CS/CJ/CP/NSJ-series CX-Integrator Ver. 2.□ Operation Manual (Cat. No. W464)* in addition to this manual for how to operate the CX-Integrator.

- 1** Connect the CJ2 CPU Unit and the computer with a USB cable.
- 2** Start the CX-Integrator.
- 3** Perform automatic online connection.
 - 1) **Network – Auto Online**
 - 2) The following dialog box is displayed. Click the **Connect** Button.

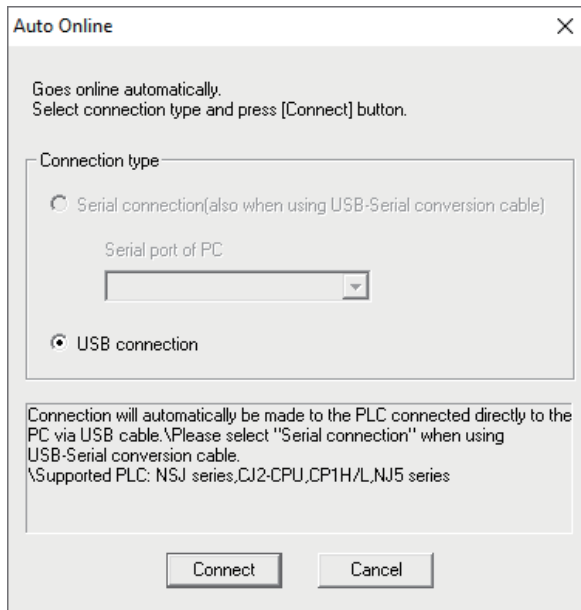

The following window is displayed.

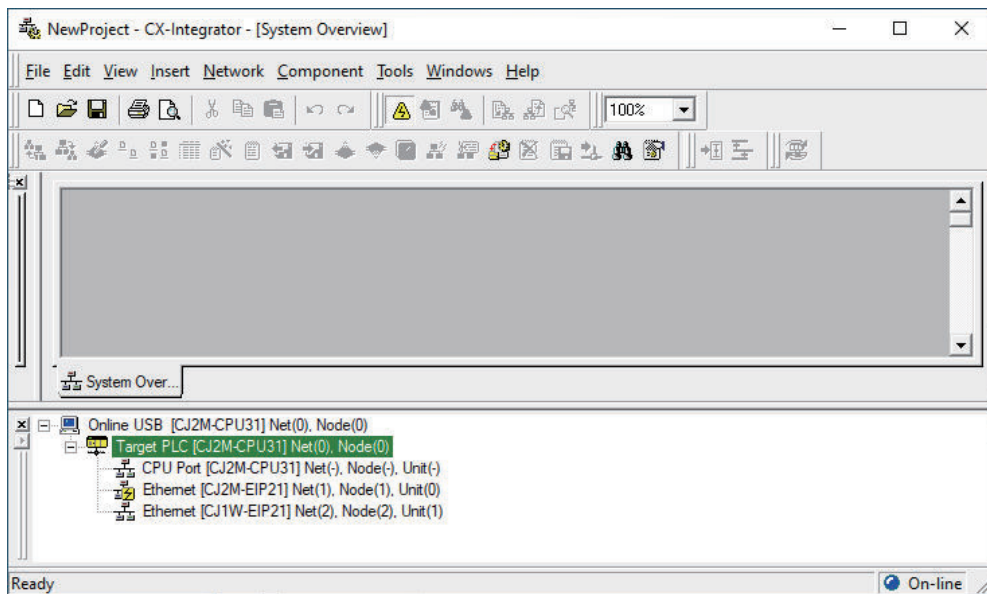

4 Start the Routing Table Component and read the routing table from the PLC.

- 1) **Tools – Start Routing table**
- 2) The following window opens. Click the **Transfer from the PLC** icon.

Transfer from the PLC Icon

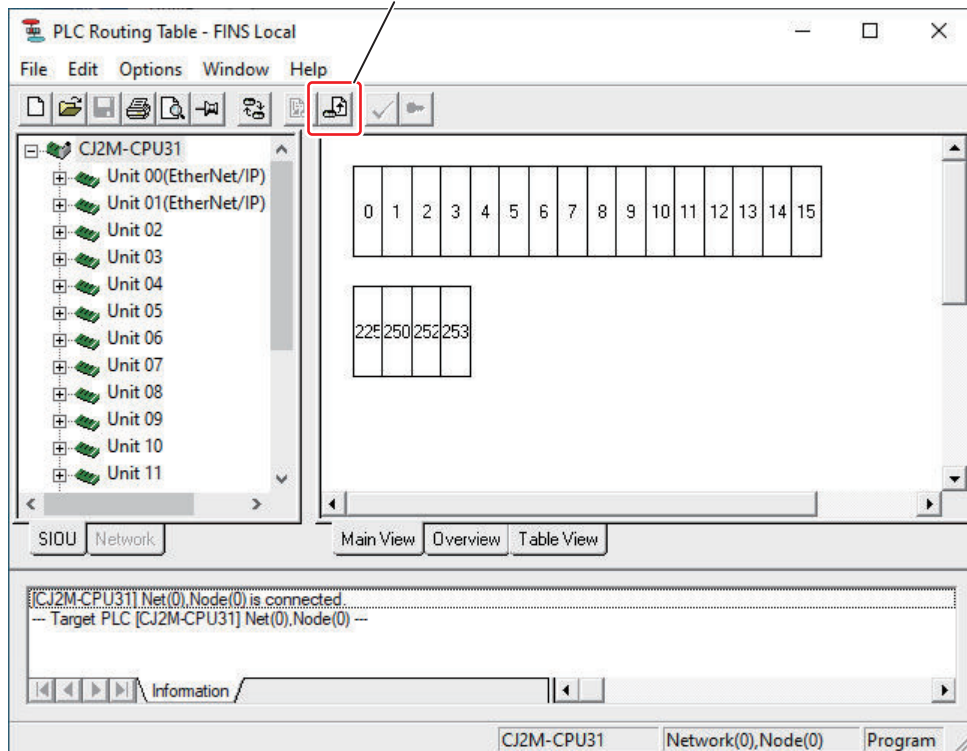

Routing table settings are read and displayed.

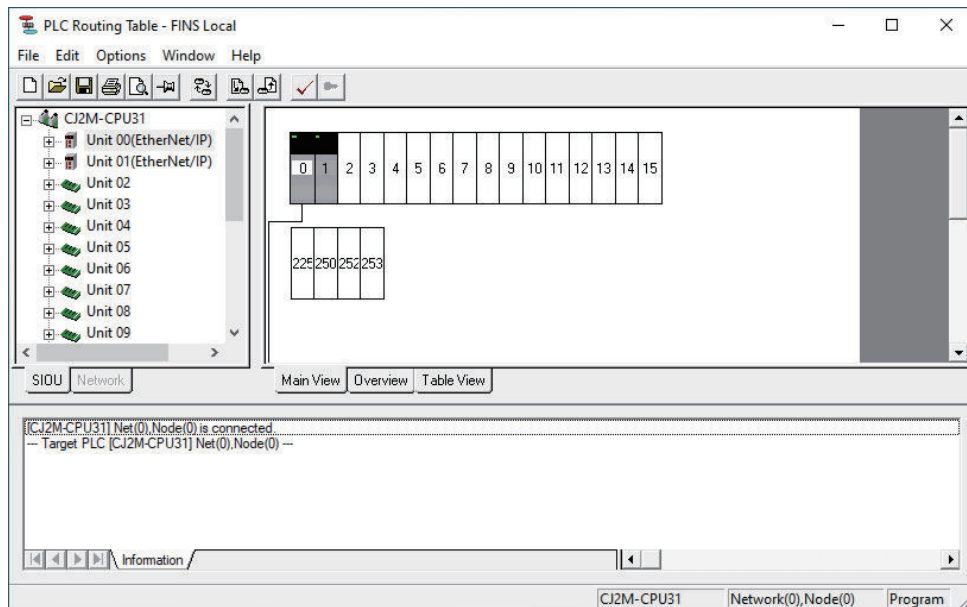

The display remains unchanged if there are no routing table settings.

- 5 Save the routing table to the computer.
File – Save Local Routing Table File

Reading the Settings of Units That Use the CPU Bus Unit Setup Area

When Units that use the CPU Bus Unit Setup Area are used in the source replacement system, read data from the setup area and save it to the computer. This data is stored in the CPU Unit. Therefore, to replace the CPU Unit, you need to move the data.

Refer to the user's manual for your CPU Bus Unit for how to check if your CPU Bus Unit uses the CPU Bus Unit Setup Area and read the set data. Note that Ethernet Units, Controller Link Units, and FL-net Units use the CPU Bus Unit Setup Area.

2-3-5 Changing the PLC

Since this step involves replacing the CPU Unit, edit the read PLC project data for the target replacement CPU Unit. If a program error occurs as a result of editing, correct it.

Prepare the project data from the source replacement model. Use the data that you read in *2-3-4 Reading and Saving Data* on page 2-19 as the master data.

Follow the steps below to change the PLC.

- 1 Start the CX-Programmer and open the project data from the source replacement model.
- 2 Double-click the PLC name in the project tree. Or, right-click the PLC name (**New PLC1** in this example) and select **Change**.

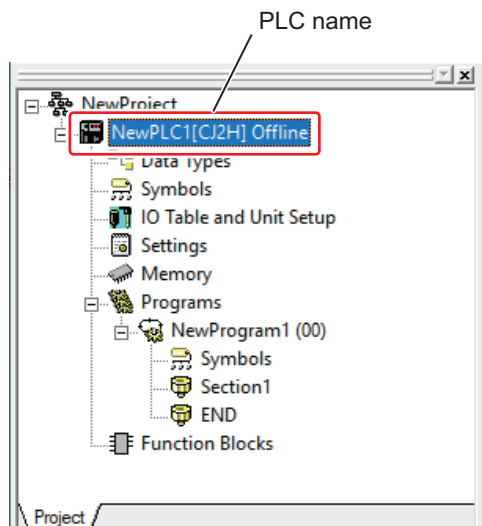

The **Change PLC** Dialog Box is displayed.

- 3 Set the PLC model and CPU type of the target replacement model.

(1) Select the device type of the target replacement model.

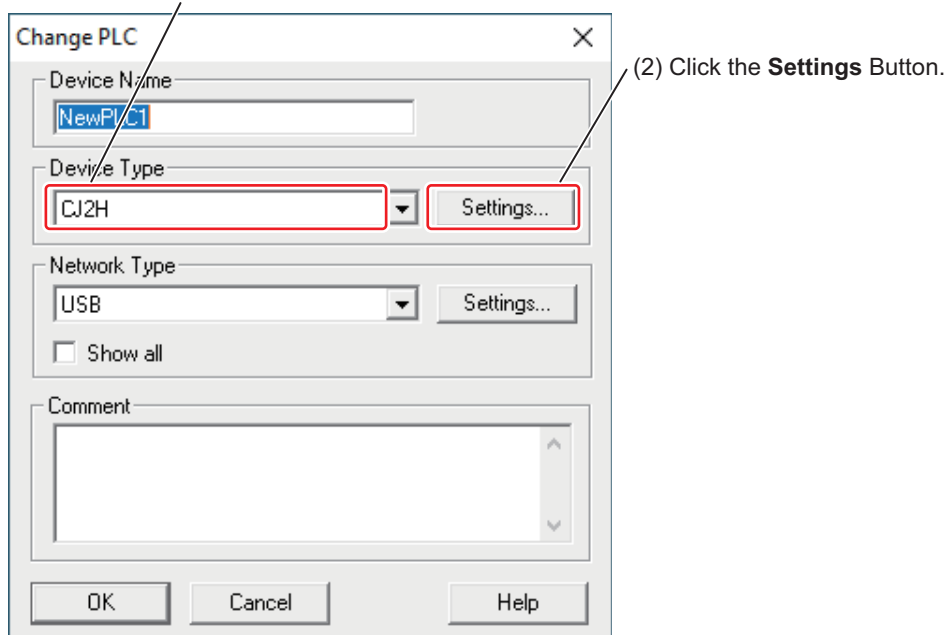

(3) Select the CPU type of the target replacement model.

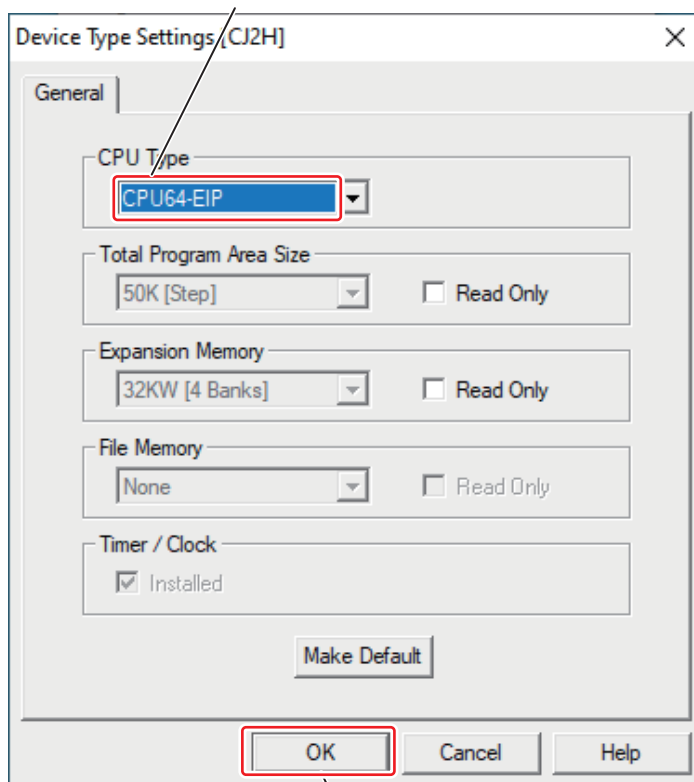

After this, click the **OK** Button in the **Change PLC** Dialog Box.
The following message is displayed.

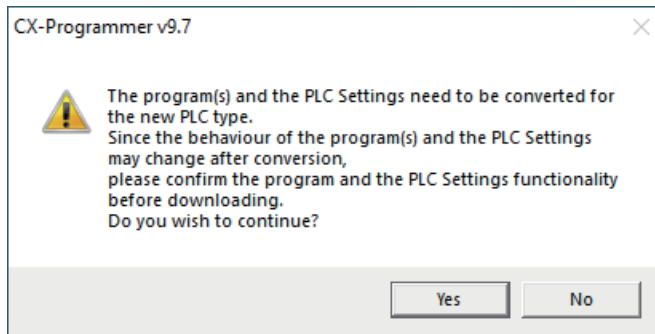

4 Click the **Yes** Button.

Depending on the target replacement model, the user program and project data such as symbols or PLC settings is converted.

If an error report is displayed at this time, use the Support Software or manually correct the errors based on the error report, and then check the program to make sure that there are no errors. Refer to the *CX-Programmer Ver. 9.□ Operation Manual (Cat. No. W446)* for how to check the program.

After you change the PLC, the following project data except for the user program may be initialized.

- I/O table
- PLC settings
- Special Unit settings
- PLC memory

If any of the above data is initialized, correct it. Note that, in this case, the I/O table and Special Unit settings are always initialized. If data is initialized, correct it in subsequent steps.

2-3-6 Creating an I/O Table

Create an I/O table to match the Unit configuration after replacement. Changing the PLC causes the I/O table in the PLC project data to be initialized. Therefore, use the CX-Programmer to create an I/O table offline to match the Unit configuration after replacement.

The following shows how to create an I/O table with the CX-Programmer.

Refer to the *CX-Programmer Ver. 9.□ Operation Manual (Cat. No. W446)* in addition to this manual for details on I/O tables and how to operate the CX-Programmer.

- 1 Use the CX-Programmer and open the I/O table for the project data after you change the PLC.
- 2 In the IO Table Dialog Box, add Units to match the Unit configuration after replacement.
 - 1) Right-click an Empty Slot and select **Add Unit**. Or, double-click it.

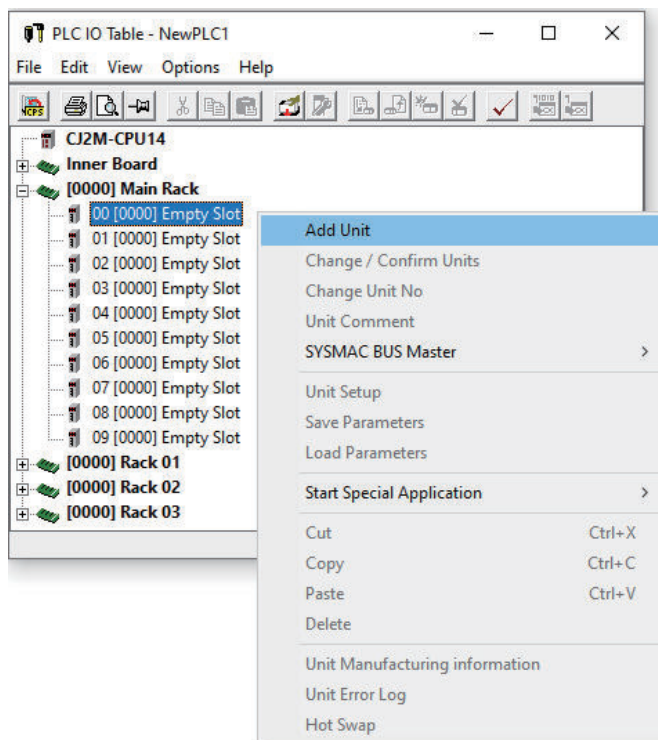

The **Select Unit** Dialog Box is displayed.

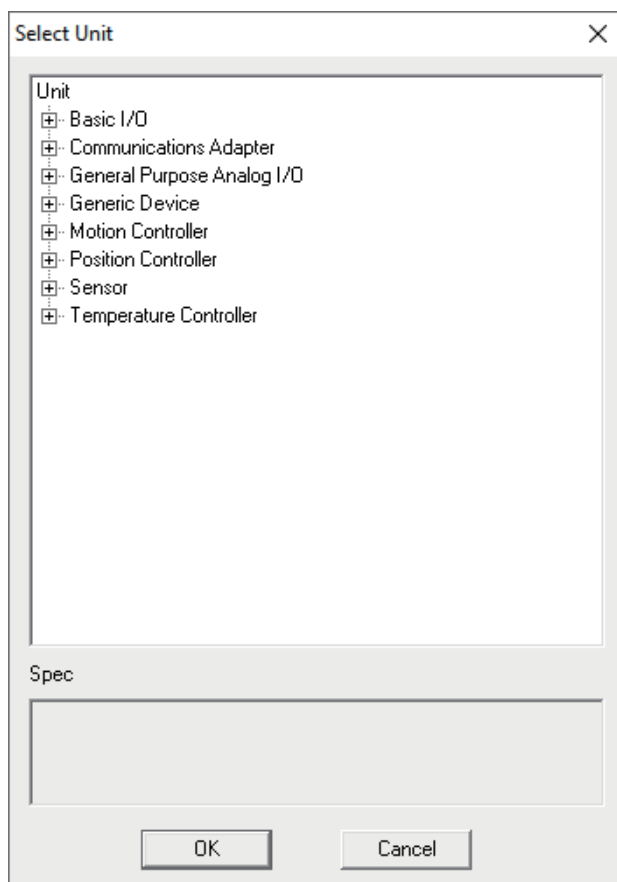

2) Select the Unit and click the **OK** Button.

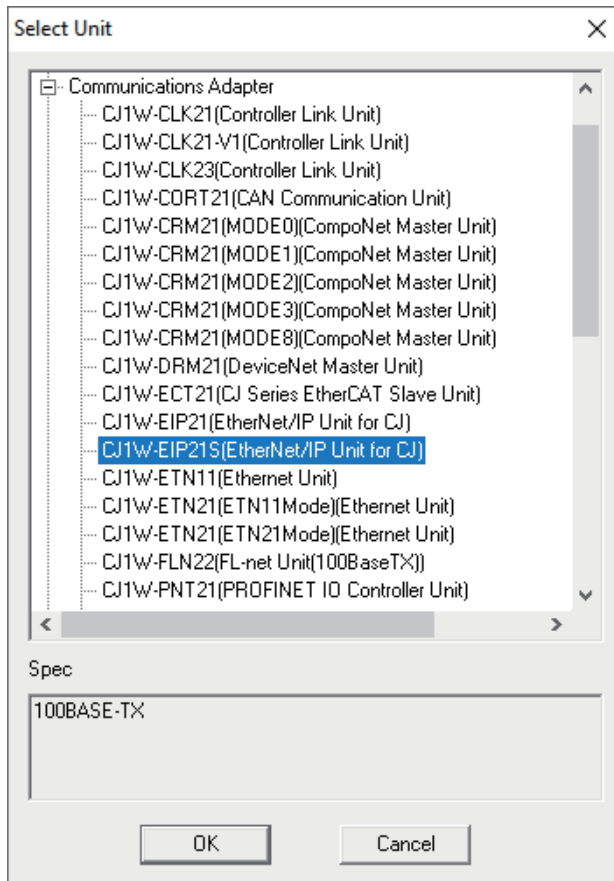

3) The **Add Unit** Dialog Box opens. Select the unit number and click the **OK** Button.

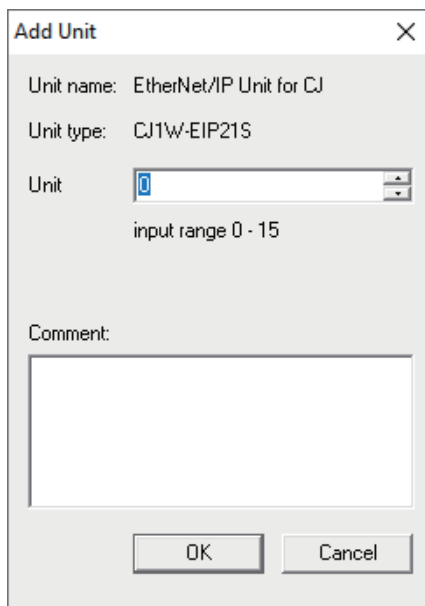

The Unit is added.

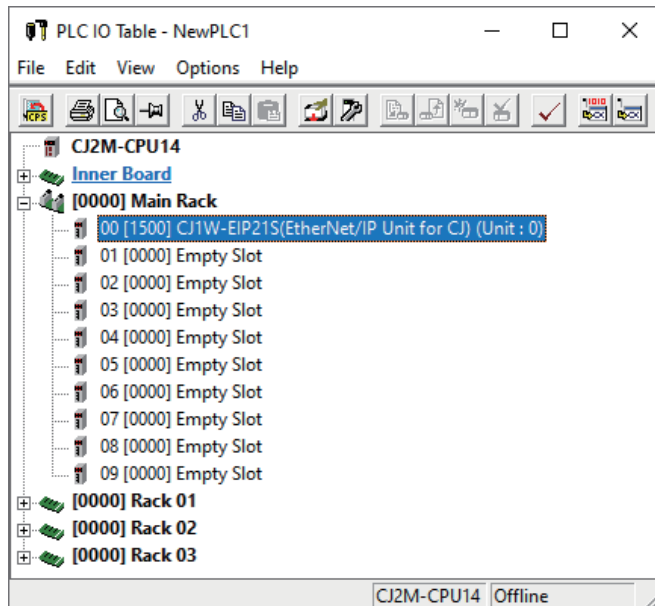

- 3** Repeat step 2 to create an I/O table to match the Unit configuration after replacement.
Example

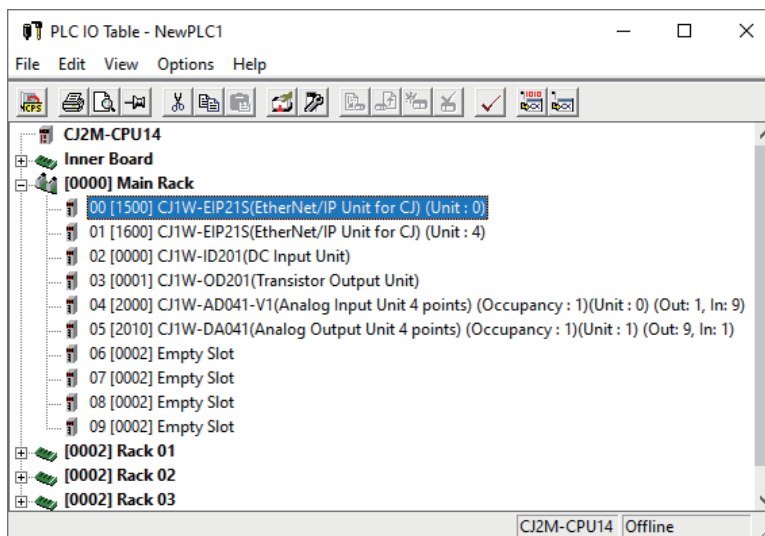

Additional Information

If you create an I/O table by reading from the actual PLC:

You can also create an I/O table by reading the I/O table and Special Unit settings from the actual PLC after replacement. However, in this case, you cannot perform the following.

- Preparing data in advance
- Using the I/O table to determine the current consumption and Unit width

Follow the steps below.

1. Turn ON the power supply to the actual PLC after replacement. Connect the CX-Programmer directly to the CPU Unit, place it online, and read the I/O table and Special Unit settings. Executing the I/O table creation command causes the EtherNet/IP Unit to be restarted. After the EtherNet/IP Unit is restarted, perform the transfer operation.
2. Place the CX-Programmer offline and create an I/O table.

2-3-7 Selecting the Power Supply Unit and Checking the Dimensions**⚠ CAUTION**

Use the Power Supply Unit and supply voltage specified in this manual if you use the CJ1W-EIP21S or CS1W-EIP21S with the power OFF detection time. If you use a Power Supply Unit that is not specified, the CJ1W-EIP21S or CS1W-EIP21S may fail to start due to malfunction.



The following restrictions on the power supply apply when you replace the EtherNet/IP Unit with the CJ1W-EIP21S or CS1W-EIP21S.

1. CJ1W-PD022 Cannot Be Used
2. Restrictions on the Power Supply Unit with or without the Power OFF Detection Time
3. Increase in Current Consumption

Check if changing the Power Supply Unit is necessary due to these restrictions, and select an adequate Power Supply Unit if necessary.

If the source replacement Power Supply Unit meets these restrictions, there is no need to change the Power Supply Unit.

If the source replacement Power Supply Unit does not meet these restrictions, you need to choose not to set the power OFF detection time, or change the Power Supply Unit or expand the system configuration.

Changing the Power Supply Unit or expanding the system configuration may result in increased dimensions. Check also the dimensions.

The following topics provide details on the restrictions on the power supply and information on checking the dimensions.

Restrictions on the Power Supply

The following restrictions are described.

● (1) CJ1W-PD022 Cannot Be Used

If the source replacement model is a CJ-series PLC, you cannot use the CJ1W-PD022 Power Supply Unit.

You need to change it to a different CJ-series Power Supply Unit.

● (2) Restrictions on the Power Supply Unit with or without the Power OFF Detection Time

The restrictions on the Power Supply Unit apply with or without the power OFF detection time in the PLC Settings Window.

- a. Without the power OFF detection time

When the power OFF detection time is not set, no restrictions apply. However, this excludes the CJ1W-PD022, to which restriction (1) applies. Here, “not set” means that the default value 0 ms is not changed.

- b. With the power OFF detection time

The table below shows whether or not Power Supply Units are applicable depending on the condition of supply voltage when the power OFF detection time is set.

Yes: Applicable, No: Not applicable, ---: Not supported

Power Supply Unit		Condition of supply voltage and applicability of Power Supply Unit*1			Remarks
Supported PLC	Model	200 VAC or higher	Lower than 200 VAC	DC input	
CJ Series (CJ1, CJ2)	CJ1W-PA202	Yes	No	---	---
	CJ1W-PA205C	Yes	No	---	---
	CJ1W-PA205R	Yes	No	---	---
	CJ1W-PD025	---	---	No	---
	CJ1W-PD022	---	---	No	This PLC is not applicable with or without the power OFF detection time.
CS Series (CS1)	C200HW-PA204	Yes	No	---	Depending on the date of manufacture, the supply voltage is not wide range, but is switchable. For details, refer to the <i>CS-series Programmable Controllers Operation Manual (Cat. No. W339)</i> .
	C200HW-PA204R	Yes	No	---	
	C200HW-PA204C	Yes	No	---	
	C200HW-PA204S	No	No	---	---
	C200HW-PA209R	No	No	---	---
	C200HW-PD024	---	---	No	---
	C200HW-PD025	---	---	No	---
CS Series (CS1D)	CS1D-PA207R	No	No	---	---
	CS1D-PD024	---	---	No	---
	CS1D-PD025	---	---	No	---

*1. Use the supply voltage within the allowable power supply voltage fluctuation range.

To continue using the power OFF detection time after replacement, use a Power Supply Unit and supply voltage that meet the restriction. In addition, some Power Supply Units may have unique restrictions that are not described in this guide. Refer to the user's manual for your CPU Unit for details on the Power Supply Unit specifications. For Power Supply Units that are not applicable due to the restrictions, consider setting the power OFF detection time to 0 ms. Refer to the user's manual for your CPU Unit for details on the power OFF detection time.

● (3) Increase in Current Consumption

Replacing the source replacement model with the C□1W-EIP21S causes the current consumption to increase from 5 VDC. For this reason, you need to confirm that the current consumption of the Unit configuration after replacement does not exceed the output capacity of the Power Supply Unit in use. For how much the current consumption increases, refer to the description of the differences

in specifications and functions in this guide. Refer to the user's manual for your CPU Unit for details on how to calculate the output capacity and current consumption of the Power Supply Unit.

This guide also introduces how to use an I/O table to calculate the current consumption. Refer to *Using an I/O Table to Calculate the Current Consumption and Unit Width* on page 2-34.

Checking the Dimensions

Changing the Power Supply Unit or expanding the system configuration may result in increased dimensions. Check the dimensions. Check the difference in the dimensions before and after change to confirm the effects on the installation space. If the configuration does not fit in the installation space, consider changing the panel size, etc.

For the CJ Series, you can use an I/O table in the CX-Programmer to calculate the width of the Unit configuration. Refer to *Using an I/O Table to Calculate the Current Consumption and Unit Width* on page 2-34 for details on using an I/O table to calculate the Unit width. Note that the CS Series does not support the use of an I/O table to calculate the width.

Using an I/O Table to Calculate the Current Consumption and Unit Width

The following shows how to use an I/O table in the CX-Programmer to calculate the current consumption and Unit width. Refer to the *CX-Programmer Ver. 9.□ Operation Manual (Cat. No. W446)* in addition to this manual for details on I/O tables and how to operate the CX-Programmer.

- 1 In the CX-Programmer, open the I/O table for the Unit configuration after replacement.

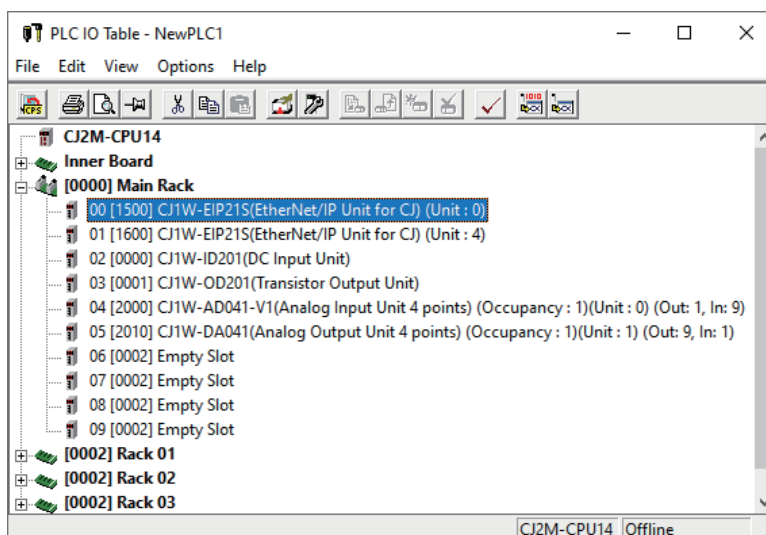

- 2 In the IO Table Dialog Box, select **Consumption and Width** from the **Options** Menu. The current consumption and width of the CPU Rack and Expansion Racks are displayed. However, the width is displayed for CJ Series only.

Rack	Power Supply Unit	I/O module	Option board	Expansion unit	Consumption(mA)		Total power consumption [W]	Width(mm)
					5V	26V/24V		
CPU Rack	CJ1W-PA202	-	-	<input checked="" type="checkbox"/>	2100		10.5	234.7
Rack 01	CJ1W-PA202	-	-	<input checked="" type="checkbox"/>	1510		7.5	245.7
Rack 02	CJ1W-PA202	-	-	<input checked="" type="checkbox"/>				
Rack 03	CJ1W-PA202	-	-	<input checked="" type="checkbox"/>				

Item	Description	Remarks
Rack	The CPU Rack or Expansion Rack is displayed.	---
Power Supply Unit	The model number of the Power Supply Unit is displayed.	---
I/O module	The model number of the Pulse I/O Module is displayed.	This can be selected only for a CJ2M CPU Unit with unit version 2.0 or later.
Option board	The model number of the Option Board is displayed.	This can be selected only for the CJ2M-CPU3□.
Expansion unit	Select this check box to use an Expansion Unit.	---
Consumption [mA]	The total current consumption of the Units registered in the I/O table is displayed for each Rack.	<ul style="list-style-type: none"> The displayed value indicates the current consumption when the Backplane with the maximum current consumption is used, although, for the CS Series, the current consumption varies depending on the model number of the Backplane. When a CJ-series Unit is added, the current consumption values for the I/O Control Unit and I/O Interface Unit are automatically displayed for each Rack.
Total power consumption [W]	The total power consumption is displayed for each Rack.	---
Width [mm]	The total width of the Units registered in the I/O table is displayed for each Rack.	This is displayed for the CJ Series only.

3 Check if the output capacity of the Power Supply Unit is exceeded. If the capacity of the Power Supply Unit is exceeded, the values will be displayed on a red background as shown below.

Rack	Power Supply Unit	I/O module	Option board	Expansion unit	Consumption(mA)		Total power consumption [W]	Width(mm)
					5V	26V/24V		
CPU Rack	CJ1W-PA202	-	-	<input checked="" type="checkbox"/>	3230		16.1	296.7
Rack 01	CJ1W-PA202	-	-	<input checked="" type="checkbox"/>	1510		7.5	245.7
Rack 02	CJ1W-PA202	-	-	<input checked="" type="checkbox"/>				
Rack 03	CJ1W-PA202	-	-	<input checked="" type="checkbox"/>				

The following rack exceeds the maximum supply power

CPU Rack

If the output capacity of the Power Supply Unit is exceeded, change the Power Supply Unit taking into account the other restrictions (1) and (2) and check again.

If the current consumption is still insufficient even after this change, consider expanding the system configuration. If the system is already expanded, consider moving the Units mounted in the same Rack to another Expansion Rack. However, even if you move the Units, do not change their unit numbers. If you change the unit numbers, the user program needs to be edited.

2-3-8 Setting Up the CPU Unit

After you create an I/O table, set up the CPU Unit in the Unit configuration after replacement. Use the CX-Programmer to edit the PLC settings. Do the following to edit the settings.

- Correcting the PLC Settings after Changing a PLC
- Dealing with Restrictions

The following topics describe these settings. Refer to the *CX-Programmer Ver. 9.0 Operation Manual (Cat. No. W446)* in addition to this manual for how to operate the CX-Programmer.

Correcting the PLC Settings after Changing a PLC

There are cases where the PLC settings are initialized because the PLC was changed after replacement of the CPU unit. For this reason, check the differences in the PLC settings before and after change. If there is any difference, correct the settings to match those before the change.

The operating procedure is shown below. This is an example of the CJ2H-CPU64. The settings and tab names displayed in the PLC Settings Window differ depending on the PLC model. Refer to the user's manual for your CPU Unit for details.

- 1** In the main window, select **Edit – Settings** from the **PLC Menu**. Or, double-click **Settings** in the project tree.
The PLC Settings Window is displayed.

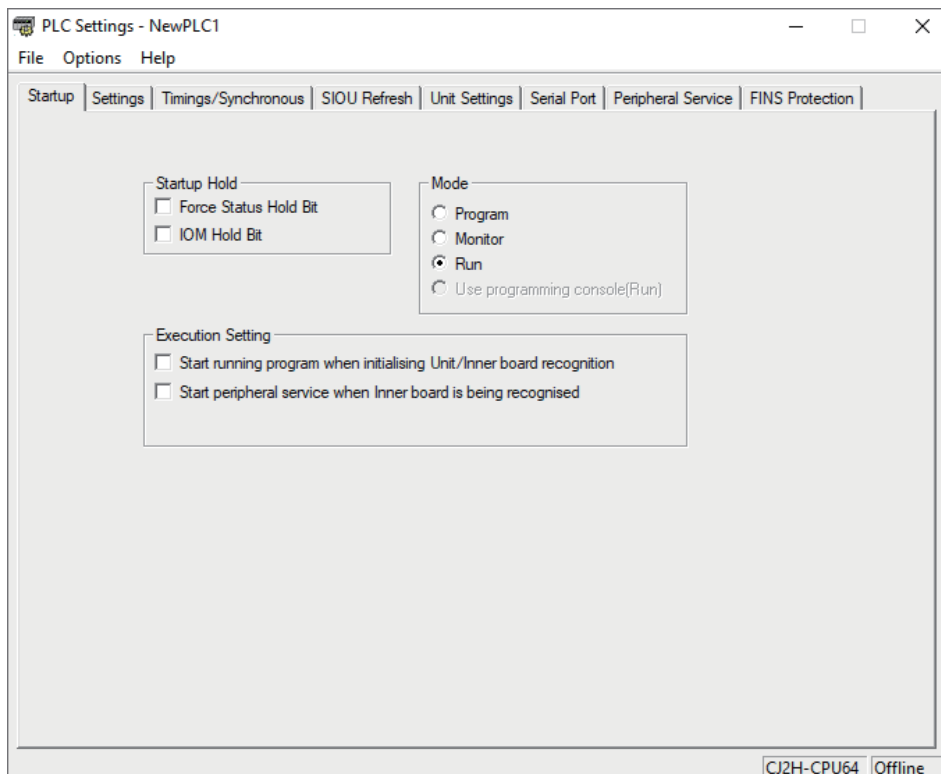

- 2 Check the differences from the PLC model before change.
If there is any difference, edit the PLC settings to match those before the change according to the PLC settings before you change the PLC.
- 3 After this, save the PLC project data.

Dealing with Restrictions

Configure the following settings in the PLC Settings Window as required to deal with the restrictions on replacement.

- **Power Off Detection Time**

After this, save the PLC project data.

In the following description, the settings window for CJ2H CPU Units is shown as an example. The settings and tab names displayed in the PLC Settings Window differ depending on the PLC model. Refer to the user's manual for your CPU Unit for details.

- **Setting the Power OFF Detection Time**

Replacing the source replacement model with the C□1W-EIP21S may not allow you to set the power OFF detection time depending on the model of the Power Supply Unit in use. Set the **Power Off Detection Time** in the PLC Settings Window according to what you did in selecting the Power Supply Unit. Refer to *2-3-7 Selecting the Power Supply Unit and Checking the Dimensions* on page 2-32 for information on selecting the Power Supply Unit.

The setting procedure is shown below.

- 1 In the main window, select **Edit – Settings** from the **PLC Menu**. Or, double-click **Settings** in the project tree.
The PLC Settings Window is displayed.
- 2 Select the **Timings/Synchronous** Tab Page. Set the **Power Off Detection Time**.
If you choose not to set the power OFF detection time after considering the restrictions, set 0 ms.

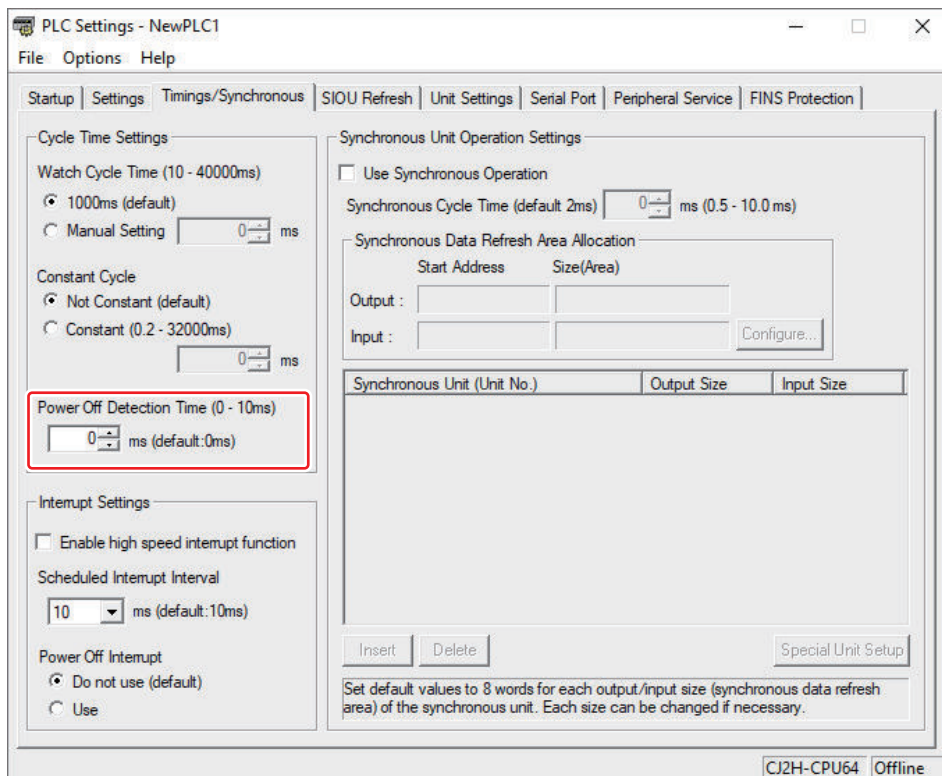

- 3 After this, save the PLC project data.

2-3-9 Setting Up the C□1W-EIP21S

After you create an I/O table, set up the C□1W-EIP21S in the Unit configuration after replacement. Configure the settings to match those of the source replacement model.

The following describes the precautions and steps that you should follow to set up the C□1W-EIP21S.

Precautions

Precautions for setting up the CPU Unit are as follows.

● Differences in Setting Parameters

There are settings with different default values between the target replacement model C□1W-EIP21S and the source replacement EtherNet/IP Unit or built-in EtherNet/IP port.

For example, for the C□1W-EIP21S, a setting for using or not using FINS/UDP service is added to the FINS/UDP settings. The default is Not use FINS/UDP service.

On the other hand, the source replacement EtherNet/IP Unit or built-in EtherNet/IP port does not have the setting for using or not using FINS/UDP service. The default is Use FINS/UDP service.

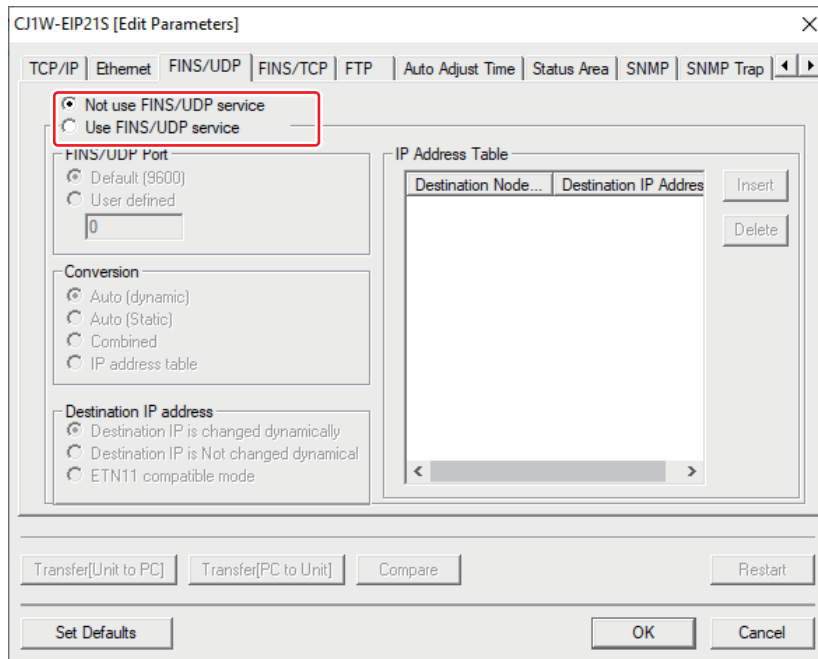

In addition to this, there are other settings that differ. Refer to *2-1 Differences in Specifications, Functions, Etc.* on page 2-2 for the differences in specifications and functions between the source and target replacement models. Refer to the *CS/CJ-series EtherNet/IP Units Operation Manual (Cat. No. W465)* for details on the settings.

● Getting an IP Address from the BOOTP Server

Replacing the Unit with a different model means that the MAC address of the Ethernet port is different before and after the replacement. Therefore, you need to change the settings of the BOOTP server.

In addition, to ensure the same behavior to get an IP address from the BOOTP server before and after the replacement, make the following setting in the Unit Setup for the target replacement model C□1W-EIP21S.

- Select **Get IP address from the BOOTP server (1Shot)** in the **IP Address** group in the **TCP/IP** Tab Page.

Setting Up the C□1W-EIP21S

The following describes how to set up the C□1W-EIP21S. Refer to the *CX-Programmer Ver. 9.□ Operation Manual (Cat. No. W446)* in addition to this manual for how to operate the CX-Programmer.

- 1** In the CX-Programmer, open the I/O table for the Unit configuration after replacement.
- 2** In the IO Table Dialog Box, right-click the C□1W-EIP21S and select **Unit Setup**. Or, double-click it.
The Edit Parameters Dialog Box for the C□1W-EIP21S opens.

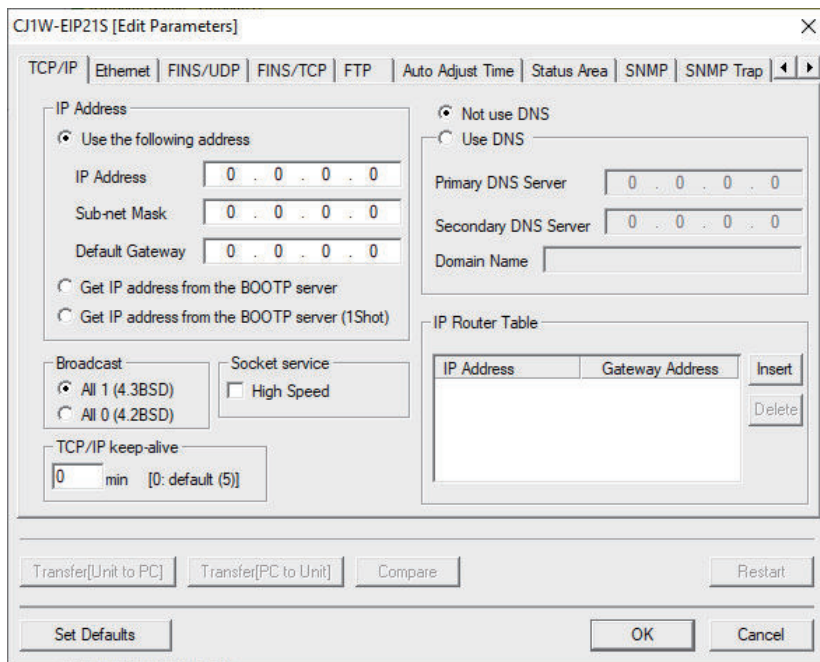

3 Configure the settings in the following tab pages to match those of the source replacement model.

- **TCP/IP, Ethernet, FINS/UDP, FINS/TCP, FTP, Auto Adjust Time, Status Area, SNMP, SNMP Trap**

Note that the source replacement model does not have the settings for using or not using the following services and, by default, you can use these services.

- FINS/TCP service
- FINS/UDP service

Therefore, configure the settings as follows.

- Set **Use FINS/TCP service** in the **FINS/TCP** Tab Page.
- Set **Use FINS/UDP service** in the **FINS/UDP** Tab Page.



Additional Information

Do not set the following security settings at this time.

- Opening and closing the port
- IP packet filtering

Configure the settings as needed after completion of replacement.

Refer to *2-4-5 Implementing Security Measures* on page 2-55 for details.

4 After this, save the PLC project data.

2-3-10 Setting Up Other Units

After you create an I/O table, set up Units other than the CPU Unit and C□1W-EIP21S in the Unit configuration after replacement.

You need to configure the following settings again.

- Special Unit settings

- Setting Up Units That Use the CPU Bus Unit Setup Area



Precautions for Correct Use

You may transfer the I/O table and Special Unit settings to the actual PLC after replacement without configuring the Special Unit settings for Units that are not the replacement target. However, doing so changes the settings for the Units that are not the replacement target. Be sure to configure the settings before you execute replacement.

Special Unit Settings

Changing the PLC model causes the I/O table and the Special Unit settings in the PLC project data to be initialized. For this reason, if you have Special Units that are not the replacement target, configure the Special Unit settings to match those of the source replacement model.

Use the CX-Programmer and follow the steps below to configure the settings to match those of the source replacement model.

- 1 In the I/O table for the source replacement Unit configuration, execute **Save Parameters** for each Special Unit except for the C□1W-EIP21S to save the settings.
 - 1) In the CX-Programmer, open the I/O table for the Unit configuration of the source replacement model.
 - 2) Right-click the Special Unit and select **Save Parameters** from the menu. The **Save As** Dialog Box is displayed.

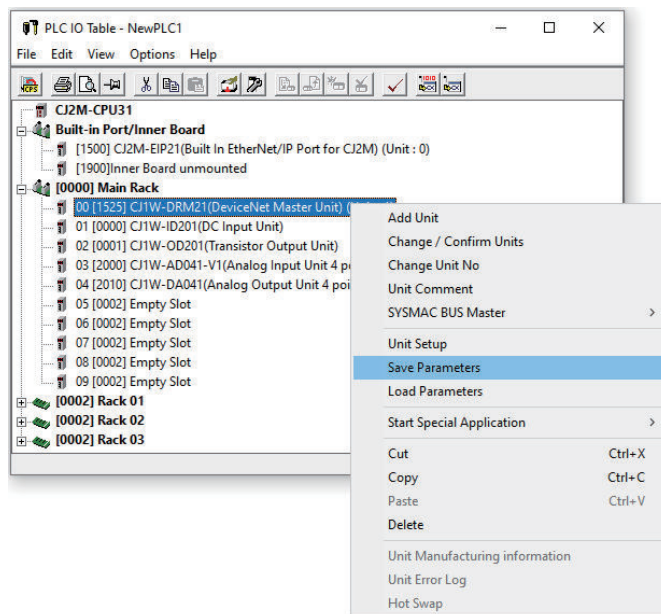

- 3) Specify a location in which to save the settings, enter any file name (extension: .xml), and save it.

- 2 In the I/O table for the Unit configuration after replacement, execute **Load Parameters** for each Special Unit for which you saved the settings in step 1 to read the settings.
 - 1) In the CX-Programmer, open the I/O table for the Unit configuration after replacement.
 - 2) Right-click the Special Unit and select **Load Parameters** from the menu.

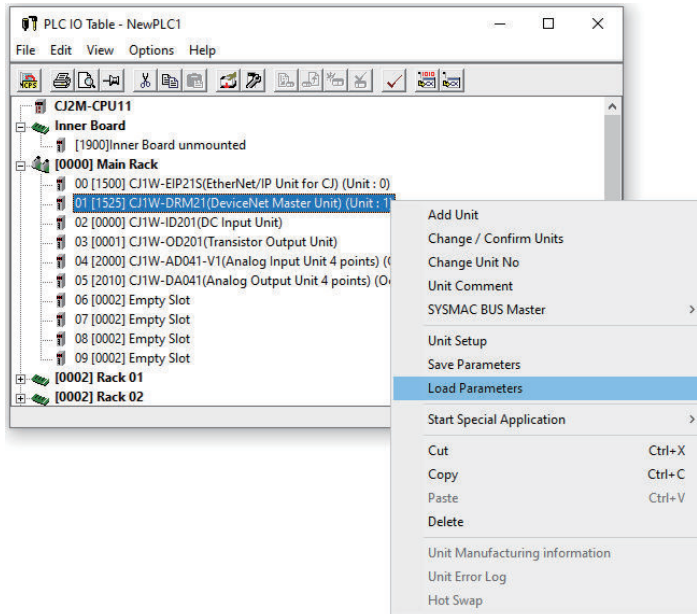

- 3) Select the file with the settings to configure, and then click the **Open** Button. At this point, be careful not to select an incorrect file. The settings of the selected file are applied to the selected Special Unit.

3 After this, save the PLC project data.

Setting Up Units That Use the CPU Bus Unit Setup Area

To replace a CPU Unit, you need to move the set data in the CPU Bus Unit Setup Area, which is stored in the CPU Unit. This means that, to use Units that use the CPU Bus Unit Setup Area, you need to configure the settings again.

Refer to the user's manual for your CPU Bus Unit for the following information.

- Whether or not the CPU Bus Unit Setup Area is used
- Contents and setting method of the data

For Units that are configured in the Unit Setup in the CX-Programmer, set the data here. For Units that are configured in Support Software other than the CX-Programmer, set the data that you read in advance in *2-3-4 Reading and Saving Data* on page 2-19 to the actual PLC after replacement.

2-3-11 Correcting PLC Memory

If PLC memory is initialized by changing the PLC model, correct the data in the target replacement model to match that of the source replacement model.

Use the CX-Programmer and follow the steps below to match the data to that of the source replacement model.

- 1 With the project data from the source replacement PLC displayed in the PLC Memory Window, execute **Save To File** to save the memory information in each area to a file.
 - 1) In the CX-Programmer, open the PLC project file from the source replacement model.
 - 2) In the project tree, double-click **Memory**. Or, in the main window, select **Edit – Memory** from the **PLC** Menu.

The following PLC Memory Window is displayed.

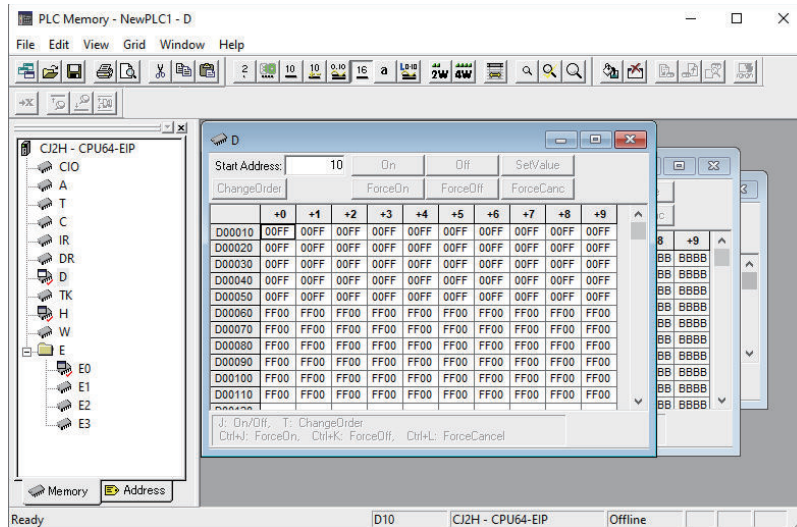

This window displays the data table for each memory area that contains data.

- 3) In the PLC Memory Window, select **Save To File** from the **File** Menu. The **Save** Dialog Box is displayed.

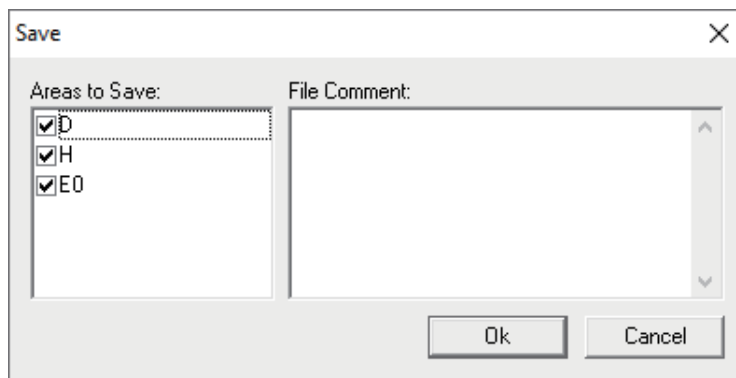

- 4) Select the check boxes for all areas that contains the data to save, and click the **OK** Button. The **Save As** Dialog Box is displayed.
- 5) Specify a location in which to save the data, enter any file name (extension: .mem), and save it.

2 With the PLC project data after replacement displayed in the PLC Memory Window, execute **Open File** to read the memory information for areas that you saved in step 1. At this point, be careful not to select an incorrect file.

- 1) In the CX-Programmer, open the PLC project file after replacement.
- 2) In the project tree, double-click **Memory**. Or, in the main window, select **Edit – Memory** from the **PLC** Menu. The PLC Memory Window opens.
- 3) In the PLC Memory Window, select **Open File** from the **File** Menu.
- 4) Select the file that you saved, and then click the **Open** Button. The memory information is read.
- 5) In the PLC Memory Window, select **Save in Project** from the **File** Menu to save it.

- 3 After this, save the PLC project data.



Precautions for Correct Use

Make sure that the memory size of each area is the same between the source and target replacement CPU Units, and correct the PLC memory by editing the PLC memory file.

2-3-12 Correcting the User Program

Correct the user program to deal with the differences in specifications due to the replacement and the restrictions that apply. Refer to *2-1 Differences in Specifications, Functions, Etc.* on page 2-2 for differences that affect the user program among those from the source replacement model.

For the C□1W-EIP21S, socket service functions are assigned to reserved and unused bits of the allocated CIO Area and DM Area words. If, in the source replacement model, the reserved or unused bits are used by a program, the program needs to be corrected.

If the Option Board Error Flag is monitored by the CJ2M-CPU3□, the user program needs to be corrected.

After you correct the user program, save the PLC project data.

2-3-13 Configuring Tag Data Links

Configure tag data links to match the Unit configuration after replacement. There is no need to reconfigure them from scratch.

Use the Network Configurator and execute the Change Device Type function on the network configuration file for the source replacement model to change the source replacement model to the C□1W-EIP21S.

Refer to the *CS/CJ-series EtherNet/IP Units Operation Manual (Cat. No. W465)* in addition to this manual for details on how to configure and operate tag data links with the Network Configurator.

Follow the steps below to change the PLC.

- 1 Open the network configuration file for the source replacement model.

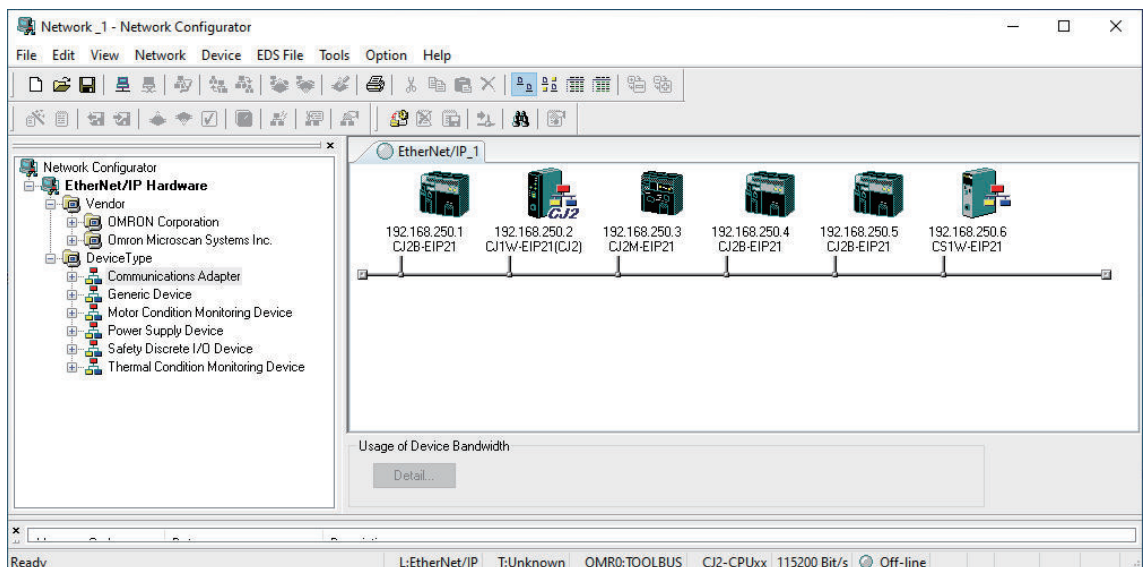

- 2 Right-click the device to replace and select **Change Device Type** from the menu. Or, click the device and select **Change Device Type** from the **Device Menu**.

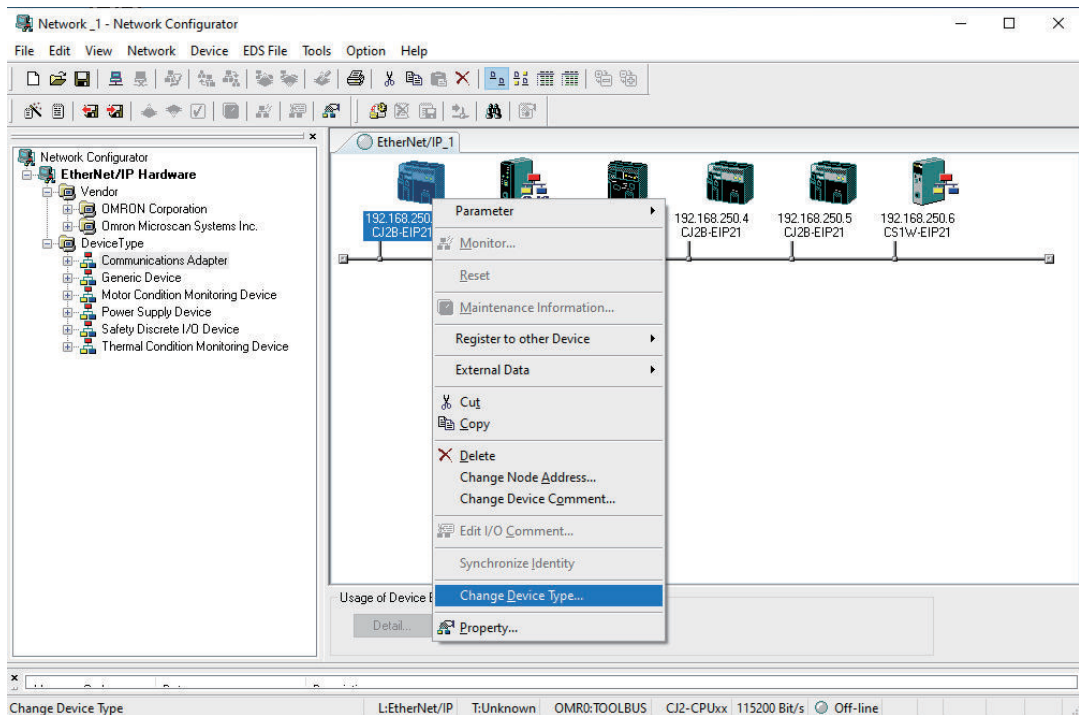

- 3 The following dialog box is displayed. Click the **Yes** Button.

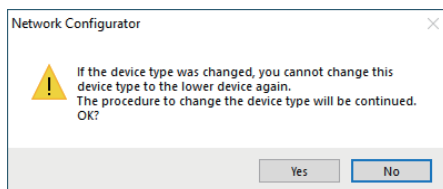

The **Change Device Type** Dialog Box is displayed.

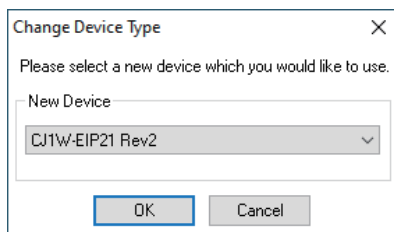

- 4 Select the device to replace and click the **OK** Button.
The table below shows the relationship between the source and target replacement Units.

Source replacement model (before change)			Target replacement model (after change)		
Name in hardware list	CIP revision	Model	Name in hardware list	CIP revision	Model
CJ2B-EIP21	Rev. 2, Rev. 3	CJ2-CPU6□-EIP	CJ1W-EIP21S (CJ2)	Rev. 4	CJ1W-EIP21S mounted on CJ2 CPU Unit
CJ2M-EIP21	Rev. 2	CJ2M-CPU3□			
CJ1W-EIP21 (CJ2)	Rev. 2, Rev. 3	CJ1W-EIP21 mounted on CJ2 CPU Unit			
CJ1W-EIP21	Rev. 1, Rev.2, Rev. 3	CJ1W-EIP21 mounted on CJ1 CPU Unit	CJ1W-EIP21S	Rev. 4	CJ1W-EIP21S mounted on CJ1 CPU Unit
CS1W-EIP21	Rev. 1, Rev.2, Rev. 3	CS1W-EIP21	CS1W-EIP21S	Rev. 4	CS1W-EIP21S

- 5** Repeat steps 2 to 4 to change the source replacement Unit to the target replacement Unit.
- 6** Save the network configuration file.

2-4 Replacement

This section describes the actual replacement steps.

2-4-1 Replacing and Wiring Units

Replace and wire Units. Refer to the user's manual for the target replacement Unit for the hardware setup, installation, and wiring of each Unit.

Taking into account the risk that you fail in replacement, perform simple backup with a Memory Card, or back up the PLC data with the PLC Backup Tool.

Replacing Units

Replace each Unit with the power supply turned OFF.

- **CPU Unit**

Configure the hardware settings of the target replacement CPU Unit to match those of the source replacement CPU Unit.

After this, replace the Unit.

- **CJ2-series CPU Built-in EtherNet/IP Port**

Configure the hardware settings of the CJ1W-EIP21S, i.e., the unit number and node address (default IP address), to match those of the built-in EtherNet/IP port of the source replacement model CJ2H-CPU6□-EIP or CJ2M-CPU3□.

The following is an example. After this, replace the Unit.

Example:

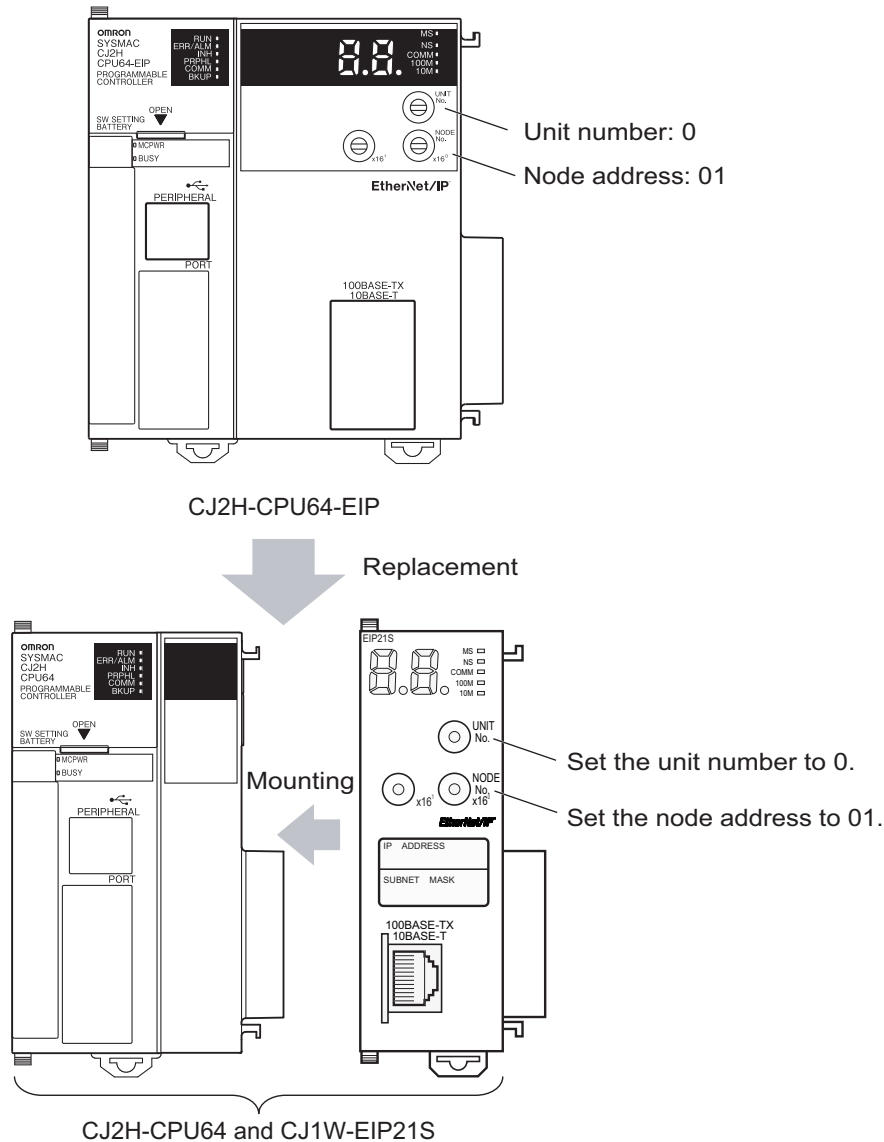

● Other Units

If you have Units to replace other than the CPU Unit and C□1W-EIP21S, replace them. For example, replace the Power Supply Unit, Expansion Rack, etc.

Wiring the Units

After replacement, wire the Units.

However, leave the Ethernet cable to the C□1W-EIP21S disconnected at this point.

2-4-2 Turning ON the Power Supply

Turn ON the power supply to the PLC after replacement.



Precautions for Correct Use

The C□1W-EIP21S requires a Unit startup time. For this reason, the CPU Unit startup time will be delayed by a few seconds compared with the system before replacement.

2-4-3 Transferring Data

From the Support Software connected directly to the CPU Unit, transfer the following data that you prepared to the actual PLC after replacement. *1

- PLC project data
- Tag data link parameters
- Routing table
- Set data for Units that use the CPU Bus Unit Setup Area

*1. This means to connect Support Software directly to the USB port or peripheral port on the CPU Unit.



Precautions for Correct Use

The C□1W-EIP21S has additional security functions, by which you can disable the EtherNet/IP port. Disabling the EtherNet/IP port accidentally prevents you from connecting the Support Software online.

Therefore, during replacement, connect the Support Software directly to the USB port, peripheral port, etc. on the CPU Unit and place it online with the PLC to allow for data transfer.

The table below shows the flow of data transfer to the actual PLC. Use this flow to transfer data.

Step	Item	Description	Reference
1	Transferring PLC Project Data	Transfer PLC project data to the CPU Unit for each PLC after replacement.	<i>Transferring PLC Project Data (to PLC)</i> on page 2-49
2	Transferring the Routing Table	Transfer the routing table to the CPU Unit for each PLC after replacement.	<i>Transferring the Routing Table (to PLC)</i> on page 2-52
3	Transferring the Settings of Units That Use the CPU Bus Unit Setup Area	Transfer the settings of Units that use the CPU Bus Unit Setup Area to the CPU Unit for each PLC after replacement.	<i>Transferring the Settings of Units That Use the CPU Bus Unit Setup Area</i> on page 2-55
4	Connecting Communications Cables	Turn OFF the power supply to each PLC. Then, connect communications cables to the target replacement model CJ1W-EIP21S.	---
5	Turning ON the Power Supply to Each PLC	Check the safety of the equipment and turn ON the power supply to each PLC.	---
6	Downloading Tag Data Link Parameters	Download all tag data link parameters for each EtherNet/IP network.	<i>Downloading Tag Data Link Parameters</i> on page 2-55

Transferring PLC Project Data (to PLC)

Transfer the PLC project data that you created to match the Unit configuration after replacement during preparation to the actual PLC. To do so, connect the CX-Programmer directly to the USB port, peripheral port, etc. on the CPU Unit and place it online.

The following is the PLC project data to transfer.

- User program
- PLC settings
- I/O table
- Special Unit settings

- PLC memory (i.e., data in the DM, EM, HR, and other areas that is retained even when the power supply is turned OFF)

● Transferring PLC Project Data

The following shows how to use the CX-Programmer to transfer PLC project data from the computer to a PLC. Here, the procedure for transferring all project data at once is shown.

Refer to the *CX-Programmer Ver. 9.□ Operation Manual (Cat. No. W446)* in addition to this manual for how to operate the CX-Programmer and connect the CPU Unit to the CX-Programmer. Refer also to the user's manual for your CPU Unit for how to connect the CPU Unit to the CX-Programmer.

Note that, in the case of replacement that does not involve replacing the CPU Unit, you can transfer only the data that is changed among project data. For example, you can transfer only the Special Unit settings of the CJ1W-EIP21S. Select how to transfer the data depending on the case of replacement and the amount of data change.

- 1** Connect the CPU Unit and the computer with a Support Software connection cable, etc.
- 2** Start the CX-Programmer.
- 3** Open the project data file that you created during preparation.
File – Open
- 4** Connect the CX-Programmer online to the PLC and change to PROGRAM mode.
PLC – Work Online
PLC – Operating Mode – Program
- 5** Transfer project data to the PLC.
PLC – Transfer – To PLC

- (1) Select the check box for the data to transfer. If the CPU Unit is replaced, select all the check boxes.

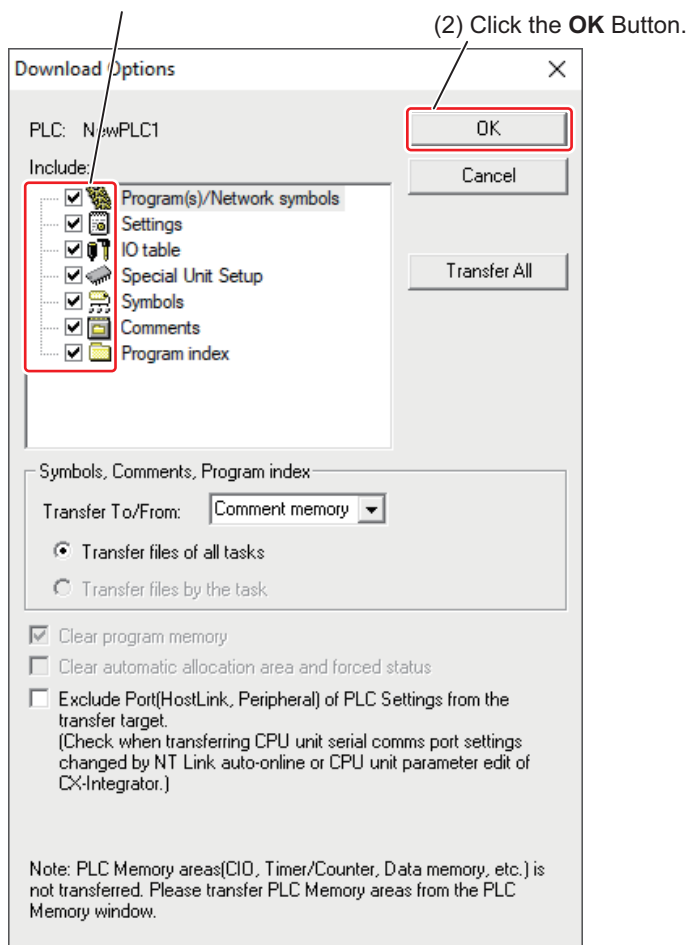

- 6** Transfer PLC memory. This is an example of transferring data from the DM Area.
PLC – Edit – Memory

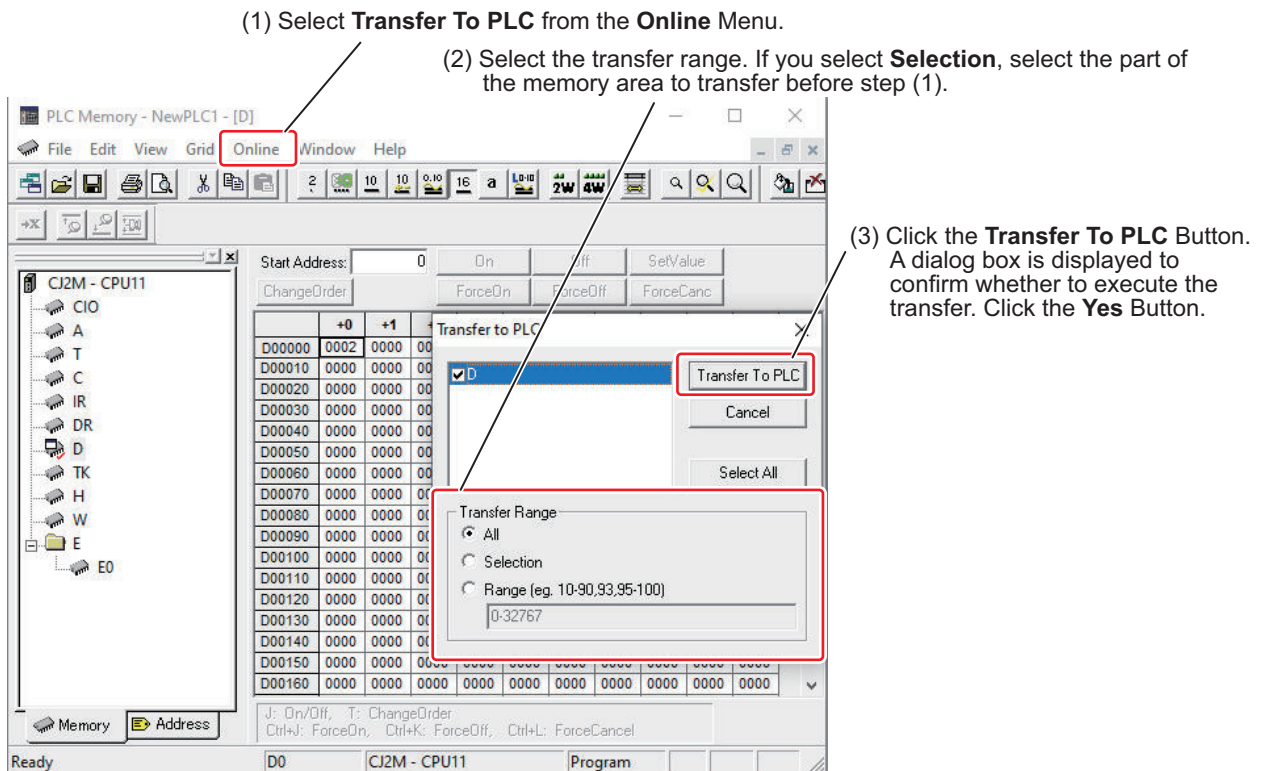

This transfers data from the computer's data memory (DM) to the PLC. In the same way, transfer the PLC memory data that you created during preparation, except for data in the DM Area.

Transferring the Routing Table (to PLC)

The following procedure is available only when you created a routing table in the source replacement model. Transfer the routing table that you read and saved during preparation to the PLC. To do so, connect the CX-Integrator directly to the USB port, peripheral port, etc. on the CPU Unit and place it online.

● Transferring the Routing Table

The following shows how to transfer the routing table to a PLC with the CX-Integrator. Refer to the *CS/CJ/CP/NSJ-series CX-Integrator Ver. 2.0 Operation Manual (Cat. No. W464)* in addition to this manual for how to transfer the routing table.

- 1** Connect the CJ2 CPU Unit and the computer with a USB cable.
- 2** Start the CX-Integrator.
- 3** Perform automatic online connection.
 - 1) **Network – Auto Online**
 - 2) The following dialog box is displayed. Click the **Connect** Button.

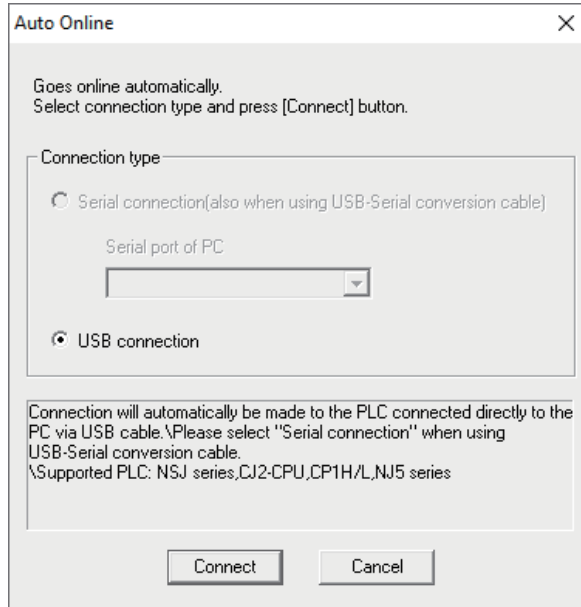

The following window is displayed.

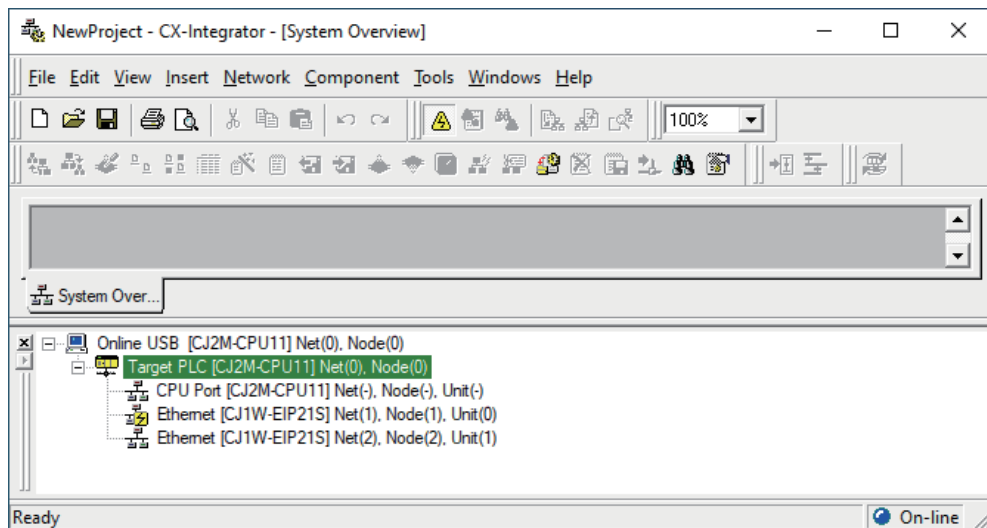

4 Start the Routing Table Component.

Tools – Start Routing table

The following window is displayed.

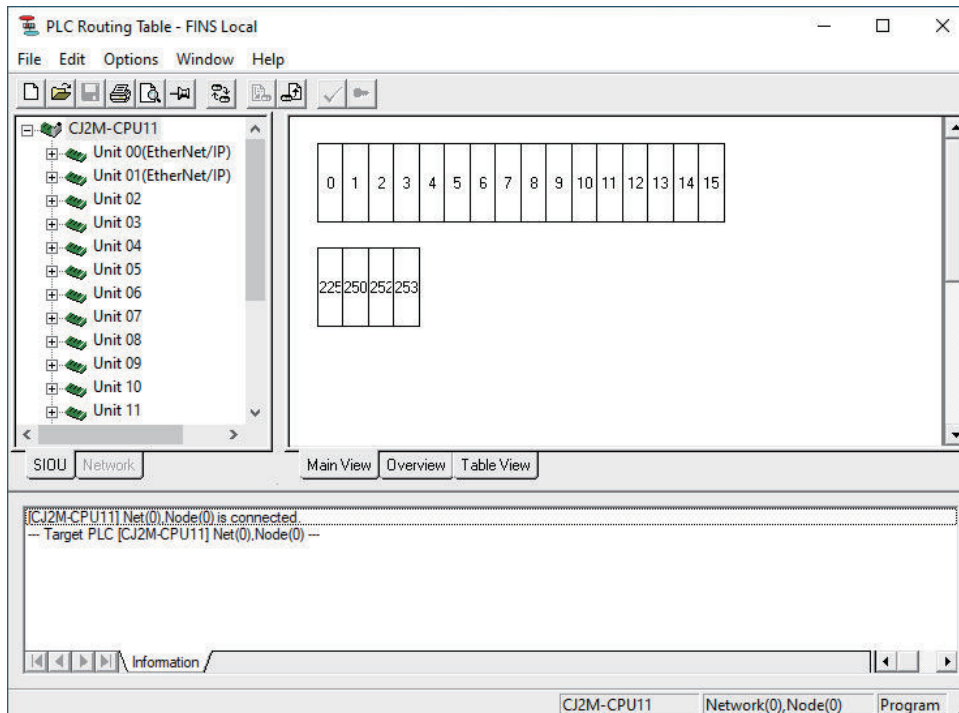

5 Read the routing table that you saved during preparation.

File – Open Local Routing Table File

6 Click the **Transfer to the PLC** icon.

Transfer to the PLC icon

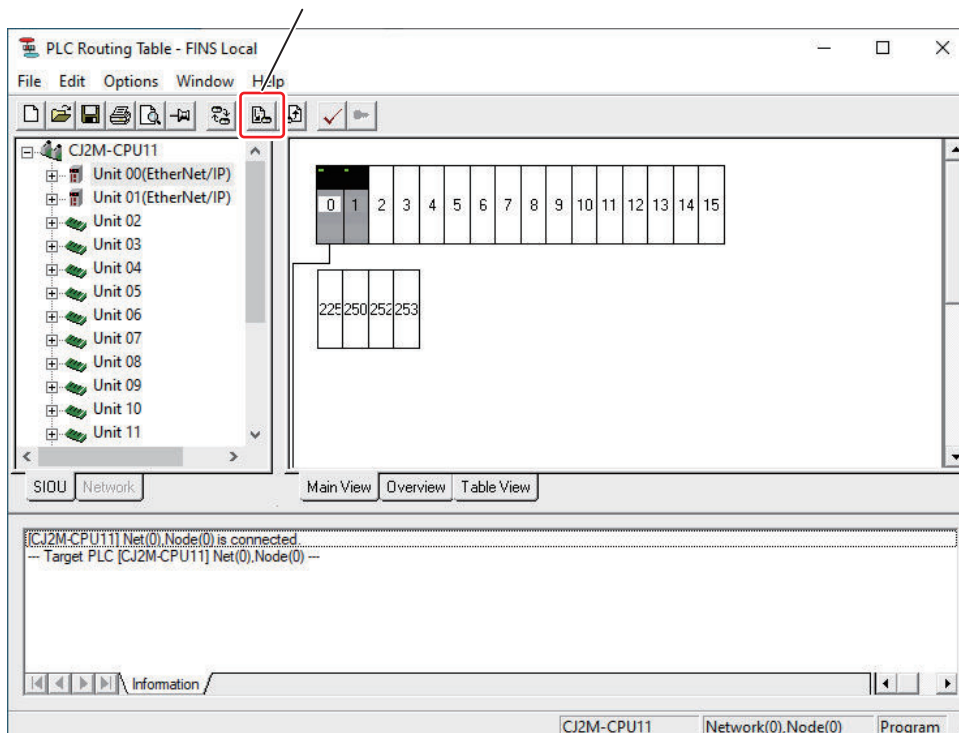

The following dialog box is displayed. Click the **Yes** Button.

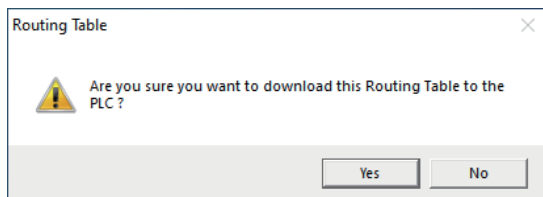

The following dialog box is displayed. The transfer is now completed.

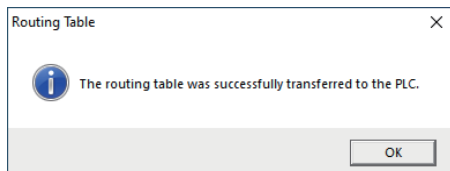

Transferring the Settings of Units That Use the CPU Bus Unit Setup Area

This procedure is available only when you use Units that use the CPU Bus Unit Setup Area in the source replacement model.

Transfer the Unit settings that you created during preparation to the Unit. To do so, connect the Unit directly to the USB port, peripheral port, etc. on the CPU Unit and place it online.

Refer to the user's manual of the Unit for details on how to transfer the set data.

Downloading Tag Data Link Parameters

This procedure is available when you use tag data links in the source replacement model. Download the tag data link settings that you created to match the Unit configuration after replacement during preparation to the actual PLC.

To do so, connect the Network Configurator directly to the USB port, peripheral port, etc. on the CPU Unit and place it online with the EtherNet/IP port via the CPU Unit. Go online and download all tag data link parameters at once to the EtherNet/IP Unit or built-in EtherNet/IP port in the EtherNet/IP network that is connected to the EtherNet/IP port.

Refer to the *CS/CJ-series EtherNet/IP Units Operation Manual (Cat. No. W465)* for details on how to download and operate tag data links with the Network Configurator.

2-4-4 Checking the Operation

After you transfer data, use the CX-Programmer to check that the system is operating as intended.

Check also that no error occurs according to the specified error check procedure for each Unit.

Refer to the user's manual for your Unit for the operation check and troubleshooting procedures for each Unit.

2-4-5 Implementing Security Measures

If necessary, implement measures to reduce the security risks from external attacks before the start of system operation after replacement. We recommend that you set user authentication and use secure

communications (Secure Comm) to connect the Support Software online to the CJ1W-EIP21S EtherNet/IP port.

In addition to user authentication and secure communications (Secure Comm), the C□1W-EIP21S and Support Software provide other security functions to reduce security risks. Use these security functions in conjunction with system operation to further reduce the security risks.

Refer to the *CS/CJ-series EtherNet/IP Units Operation Manual (Cat. No. W465)* for details on the security functions available with the C□1W-EIP21S. Refer to the *CX-Programmer Ver. 9.□ Operation Manual (Cat. No. W446)* for details on the security functions available with the Support Software.

This section shows the procedure for setting user authentication and an overview of the security measures.

Setting User Authentication

Configure the settings to allow the user to connect the Support Software online to the EtherNet/IP port on the C□1W-EIP21S by entering a user name and password. The user authentication settings are registered in the C□1W-EIP21S. To reduce security risks, register at least one administrator user account.

The following describes how to configure the authentication settings for the first user.

Before you perform the following procedure, set the IP address of the computer's Ethernet port to connect to in the C□1W-EIP21S according to the IP address of the destination node.

- 1 Connect the EtherNet/IP port on the C□1W-EIP21S and the computer with an Ethernet cable.
- 2 Start the CX-Programmer.
- 3 In the CX-Programmer, select **Tools – EIP21S User Management Tool** from the Tools Menu. The EIP21S User Management Tool starts.

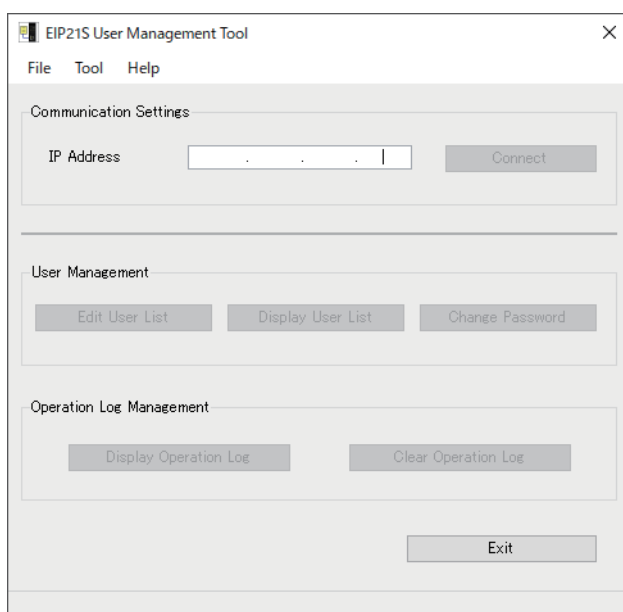

- 4 In **IP Address** in the **Communication Settings** group, enter the IP address of the C□1W-EIP21S to connect to. After you enter the IP address, click the **Connect** Button.

The **Administrator Registration** Dialog Box is displayed.

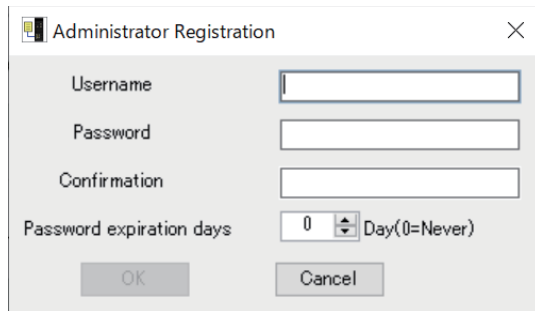

The Administrator Registration dialog box contains the following fields and controls:

- Username:** A text input field.
- Password:** A password input field.
- Confirmation:** A text input field for re-entering the password.
- Password expiration days:** A numeric input field with a dropdown arrow, currently set to 0, with the text "Day(0=Never)" to its right.
- Buttons:** "OK" and "Cancel" buttons at the bottom.

- 5** Enter the administrator's user name, password, confirmation password, and expiration days in **Username**, **Password**, **Confirmation**, and **Password expiration days**, respectively. After you enter the information, click the **OK** Button.

Item	Setting range
Username	<ul style="list-style-type: none"> • Single-byte alphanumeric characters, case sensitive • 1 to 16 characters
Password, Confirmation	<ul style="list-style-type: none"> • Single-byte alphanumeric characters, case sensitive • 8 to 32 characters
Password expiration days	Set 0 to 999 0: Never 1 to 999: Expiration days

A notification dialog box is displayed to notify you of the completion of the administrator registration.

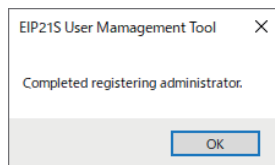

The notification dialog box, titled "EIP21S User Management Tool", displays the message "Completed registering administrator." and has an "OK" button at the bottom.

- 6** Click the **OK** Button.
The **User Authentication** Dialog Box is displayed.

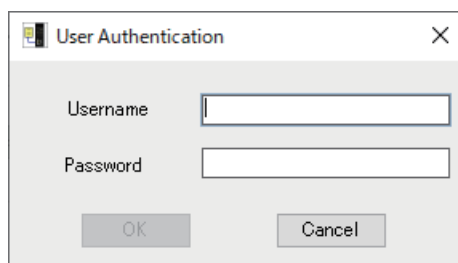

The User Authentication dialog box contains the following fields and controls:

- Username:** A text input field.
- Password:** A password input field.
- Buttons:** "OK" and "Cancel" buttons at the bottom.

- 7** Enter the user name and password that you registered in step 5 and click the **OK** Button.
A notification dialog box is displayed to notify you of the success of the user authentication.
Click the **OK** Button.

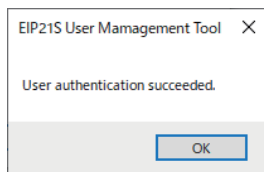

The EIP21S User Management Tool goes online.

To go back to offline, in the EIP21S User Management Tool, click the **Disconnect** Button in the **Communication Settings** group.

Then, in offline, click the **Exit** Button to close the EIP21S User Management Tool.

Overview of Security Measures

The following provides an overview of the security measures.

- Use the opening and closing the port function of the C□1W-EIP21S to disable communications functions that are not used.
- Use the EIP21S User Management Tool to register user accounts by operation authority according to the roles of the users of the PLC Support Software.
- Connect the CX-Programmer, PLC Backup Tool, and EIP21S User Management Tool online via Secure Comm.
- To further reduce the security risks, use IP packet filtering of the C□1W-EIP21S to set filters according to the usage scene of the network.
- Save project files of the CX-Programmer with a password.

2-4-6 Checking the Operation after Implementing Security Measures

After you implement security measures, check to be sure that the system operates according to the security settings.

3

Replacing a System with the C□1W-EIP21

This section describes the replacement flow and replacement procedures for a system with the C□1W-EIP21.

3-1	Differences in Specifications, Functions, Etc.	3-2
3-2	Replacement Flow.....	3-10
3-2-1	Flow of Preparation	3-10
3-2-2	Flow of Replacement.....	3-11
3-3	Preparation	3-12
3-3-1	Checking the Target Replacement Model	3-12
3-3-2	Checking the Differences in Specifications, Functions, Etc.	3-12
3-3-3	Getting the Support Software	3-12
3-3-4	Reading and Saving Data	3-12
3-3-5	Creating an I/O Table	3-13
3-3-6	Selecting the Power Supply Unit and Checking the Dimensions	3-14
3-3-7	Setting Up the CPU Unit.....	3-14
3-3-8	Setting Up the C□1W-EIP21S	3-14
3-3-9	Correcting the User Program	3-14
3-3-10	Configuring Tag Data Links	3-14
3-4	Replacement.....	3-15
3-4-1	Replacing and Wiring Units	3-15
3-4-2	Turning ON the Power Supply.....	3-15
3-4-3	Transferring the I/O Table.....	3-15
3-4-4	Transferring Data.....	3-17
3-4-5	Checking the Operation.....	3-18
3-4-6	Implementing Security Measures	3-19
3-4-7	Checking the Operation after Implementing Security Measures	3-19

3-1 Differences in Specifications, Functions, Etc.

This section describes the differences in specifications, functions, etc. and the restrictions that apply when you replace the C□1W-EIP21 with the C□1W-EIP21S. Check the differences in specifications, functions, etc. between the source and target replacement models, and the restrictions that apply, to determine the effects of replacement on the hardware, user program, and applications in the source replacement system.

The following items are described.

Item	Reference
Differences in Unit Functions and Specifications	<i>Differences in Unit Functions and Specifications</i> on page 3-2
Differences in Memory Allocation	<i>Differences in Memory Allocation</i> on page 3-8
Restrictions	<i>Restrictions</i> on page 3-9

Differences in Unit Functions and Specifications

The tables below show functions and specifications that differ and the effects of the replacement. Specifications and functions that differ between the CS Series and CJ Series are described in separate rows with the notations of "CS:" and "CJ:". Those without differences between the CS Series and CJ Series are given without distinction.

● Hardware Specifications

CS: CS Series, CJ: CJ Series

Item	Source replacement model	Target replacement model	Effects of replacement
	C□1W-EIP21 (CS: CS1W-EIP21, CJ: CJ1W-EIP21)	C□1W-EIP21S (CS: CS1W-EIP21S, CJ: CJ1W-EIP21S)	
Weight	CS: 171 g max.	CS: 180 g max.	The weight increases 9 g. Check if the increase will have any effect.
	CJ: 94 g max.	CJ: 91 g max.	The weight decreases 3 g. There is no effect.
Current consumption	0.41 A max. at 5 VDC	CS: 0.62 A max. at 5 VDC	The current consumption increases 0.21 A. If the power supply is insufficient, you need to replace the Power Supply Unit, or change the system configuration to use an Expansion Rack. For details, refer to 3-3-6 <i>Selecting the Power Supply Unit and Checking the Dimensions</i> on page 3-14.
		CJ: 0.65 A max. at 5 VDC	The current consumption increases 0.24 A. If the power supply is insufficient, you need to replace the Power Supply Unit, or change the system configuration to use an Expansion Rack. For details, refer to 3-3-6 <i>Selecting the Power Supply Unit and Checking the Dimensions</i> on page 3-14.

● Functions and Specifications

CS: CS Series, CJ: CJ Series

Item	Source replacement model	Target replacement model	Effects of replacement	
	C□1W-EIP21 (CS: CS1W-EIP21, CJ: CJ1W-EIP21)	C□1W-EIP21S (CS: CS1W-EIP21S, CJ: CJ1W-EIP21S)		
Applicable PLCs	CJ: CJ Series, CP1H Series, NJ Series	CJ: CJ Series However, the following CPU Units are excluded. <ul style="list-style-type: none"> • CJ1M-CPU□□ • CJ1H-CPU□□H-R • CJ1G/H-CPU□□H • CJ1G-CPU□□ 	The CJ1W-EIP21S cannot be mounted on NJ-series CPU Units. In addition, the operation of the CJ1W-EIP21S is not guaranteed if it is mounted on the following CPU Units. <ul style="list-style-type: none"> • CP1H-series CPU Units • CJ1M-CPU□□ • CJ1H-CPU□□H-R • CJ1G/H-CPU□□H • CJ1G-CPU□□ Therefore, the CJ1W-EIP21 cannot be replaced with the CJ1W-EIP21S when it is mounted on these CPU Units.	
CPU Unit words used	Allocated CIO Area words (CPU Bus Unit words) Allocated DM Area words (CPU Bus Unit words)	Socket service functions not available	Socket service functions available	There is no difference in the words used. However, socket service functions are added to reserved and unused bits for the source replacement model. For details on allocation and effects, refer to <i>Differences in Memory Allocation</i> on page 3-8.

Item		Source replacement model	Target replacement model	Effects of replacement
		C□1W-EIP21 (CS: CS1W-EIP21, CJ: CJ1W-EIP21)	C□1W-EIP21S (CS: CS1W-EIP21S, CJ: CJ1W-EIP21S)	
CIP communications service: Tag data links (cyclic communications)	Allowed communications bandwidth per Unit	<ul style="list-style-type: none"> 12,000 pps (Unit version 3.0 or later) 6,000 pps (Unit version 2.1 or earlier) 	12,000 pps	There is no effect.
	Maximum number of tags that can be refreshed per CPU Unit cycle	CS: Output/Transmission (CPU to EtherNet/IP): 19 Input/Reception (EtherNet/IP to CPU): 20 (19 for input/reception when User defined is set for the layout of the allocated CIO Area words)	CS: Output/Transmission (CPU to EtherNet/IP): 19 Input/Reception (EtherNet/IP to CPU): 20 (18 for both of input/reception and output/transmission when User defined is set for the layout of the allocated CIO Area words)	The maximum number of tags in input/reception data will decrease when User defined is set for the layout of the allocated CIO Area words. If the maximum data size is exceeded, refreshing the data in the CPU Unit will span multiple cycles. Check the effects on communications performance.
		CJ: When mounted in the CJ1 CPU Unit Output/Transmission (CPU to EtherNet/IP): 19 Input/Reception (EtherNet/IP to CPU): 20 (19 for input/reception when User defined is set for the layout of the allocated CIO Area words)	CJ: When mounted in the CJ1 CPU Unit Output/Transmission (CPU to EtherNet/IP): 19 Input/Reception (EtherNet/IP to CPU): 20 (18 for both of input/reception and output/transmission when User defined is set for the layout of the allocated CIO Area words)	

Item		Source replacement model	Target replacement model	Effects of replacement
		C□1W-EIP21 (CS: CS1W-EIP21, CJ: CJ1W-EIP21)	C□1W-EIP21S (CS: CS1W-EIP21S, CJ: CJ1W-EIP21S)	
CIP communications service: Tag data links (cyclic communications)	Data that can be refreshed per CPU Unit cycle	CS: Output/Transmission (CPU to EtherNet/IP): 7,469 words Input/Reception (EtherNet/IP to CPU): 7,469 words (7,405 words for both input and output when User defined is set for the layout of the allocated CIO Area words)	CS: Output/Transmission (CPU to EtherNet/IP): 7,469 words Input/Reception (EtherNet/IP to CPU): 7,469 words (7,321 words for output and 7,385 words for input when User defined is set for the layout of the allocated CIO Area words)	The data size will decrease when User defined is set for the layout of the allocated CIO Area words. If the maximum data size is exceeded, refreshing the data in the CPU Unit will span multiple cycles. Check the effects on communications performance.
		CJ: When mounted in the CJ1 CPU Unit Output/Transmission (CPU to EtherNet/IP): 7,469 words Input/Reception (EtherNet/IP to CPU): 7,469 words (7,405 words for both input and output when User defined is set for the layout of the allocated CIO Area words)	CJ: When mounted in the CJ1 CPU Unit Output/Transmission (CPU to EtherNet/IP): 7,469 words Input/Reception (EtherNet/IP to CPU): 7,469 words (7,321 words for output and 7,385 words for input when User defined is set for the layout of the allocated CIO Area words)	
CIP communications service: Tag data links (cyclic communications)	Data that can be refreshed per CPU Unit cycle	CJ: When mounted in the CJ2H/CJ2M CPU Unit Output/Transmission (CPU to EtherNet/IP): 6,432 words Input/Reception (EtherNet/IP to CPU): 6,432 words (6,368 words for both input and output when User defined is set for the layout of the allocated CIO Area words)	CJ: When mounted in the CJ2H/CJ2M CPU Unit Output/Transmission (CPU to EtherNet/IP): 6,432 words Input/Reception (EtherNet/IP to CPU): 6,432 words (6,172 words for output and 6,236 words for input when User defined is set for the layout of the allocated CIO Area words)	The data size will decrease when User defined is set for the layout of the allocated CIO Area words. If the maximum data size is exceeded, refreshing the data in the CPU Unit will span multiple cycles. Check the effects on communications performance.

Item		Source replacement model	Target replacement model	Effects of replacement
		C□1W-EIP21 (CS: CS1W-EIP21, CJ: CJ1W-EIP21)	C□1W-EIP21S (CS: CS1W-EIP21S, CJ: CJ1W-EIP21S)	
FINS communications service	Type of supported FINS commands	Socket service commands not available	Socket service commands available	There is no effect.
	Setting and default for using or not using FINS/UDP service	<ul style="list-style-type: none"> Setting function: Not available Default: Use FINS/UDP service 	<ul style="list-style-type: none"> Setting function: Available Default: Not use FINS/UDP service 	To use the FINS function, you need to set Use FINS/UDP service . Refer to 3-3-8 <i>Setting Up the C□1W-EIP21S</i> on page 3-14 for details.
	Setting and default for using or not using FINS/TCP service	<ul style="list-style-type: none"> Setting function: Not available Default: Use FINS/TCP service 	<ul style="list-style-type: none"> Setting function: Available Default: Not use FINS/TCP service 	To use the FINS function, you need to set Use FINS/TCP service . Refer to 3-3-8 <i>Setting Up the C□1W-EIP21S</i> on page 3-14 for details.
	Keep-alive setting	Fixed to 5 min when the keep-alive function is in effect.	Can be set in the TCP/IP Tab Page. The default is 5 min.	There is no effect.
FTP server		Available (Unit version 2.0 or later)	Available	There is no effect.
	Default for using or not using FTP	Default: Use FTP	Default: Not Use FTP	To use the FTP function, you need to set Use FTP . Refer to 3-3-8 <i>Setting Up the C□1W-EIP21S</i> on page 3-14 for details.
	User name/password	<ul style="list-style-type: none"> User name (1 to 12 characters) Default: CONFIDENTIAL Password (1 to 8 characters) Default: - (Not set) Entered characters displayed 	<ul style="list-style-type: none"> User name (1 to 16 characters) Default: - (Not set) Password (8 to 16 characters) Default: - (Not set) Entered characters replaced by asterisks 	To use the FTP function, you need to set the user name (login name) and password again. Refer to 3-3-8 <i>Setting Up the C□1W-EIP21S</i> on page 3-14 for details.
Automatic clock adjustment		Available (Unit version 2.0 or later)	Available	There is no effect.
BOOTP client	Get the IP address from the BOOTP server at each power ON or restart	Not available	Available	There is no effect.
Simple backup function	Backup data capacity	459 KB	364 KB	There is no effect.
SNMP/SNMP trap		Available (Unit version 2.0 or later) Community name: Entered characters displayed	Available Community name: Entered characters replaced by asterisks	There is no effect.

Item		Source replacement model	Target replacement model	Effects of replacement
		C□1W-EIP21 (CS: CS1W-EIP21, CJ: CJ1W-EIP21)	C□1W-EIP21S (CS: CS1W-EIP21S, CJ: CJ1W-EIP21S)	
CIDR function for IP addresses		Available (Unit version 2.0 or later)	Available	There is no effect.
Setting for using or not using CIP message server		<ul style="list-style-type: none"> Setting function: Not available Default: Use 	<ul style="list-style-type: none"> Setting function: Available Default: Use 	There is no effect.
Security	Secure communications	Not available	Available	After replacement, we recommend using these functions to reduce security risks. Refer to 3-4-6 <i>Implementing Security Measures</i> on page 3-19 for details.
	User authentication			After replacement, determine whether or not to use this function to further reduce security risks according to your system operation. Refer to 3-4-6 <i>Implementing Security Measures</i> on page 3-19 for details.
	IP packet filtering			
	Opening and closing the port*1	Without opening and closing the port for the following services. <ul style="list-style-type: none"> FINS/UDP service FINS/TCP service CIP message server 	With opening and closing the port for the following services. <ul style="list-style-type: none"> FINS/UDP service FINS/TCP service CIP message server 	Before replacement, you need to configure the port for the service in use. Refer to 3-3-8 <i>Setting Up the C□1W-EIP21S</i> on page 3-14 for details.
Operation log		Not available	Available	There is no effect.
Socket services		Not available	Available	There is no effect.
Online connection from CX-One to CPU Unit via Ethernet/IP port with secure communications		Not available	Available	After replacement, we recommend using these functions to reduce security risks. Refer to 3-4-6 <i>Implementing Security Measures</i> on page 3-19 for details.
Online connection by Ethernet/IP using CX-One		Available	Available	After replacement, we do not recommend using this connection method to reduce security risks.
Online connection by Ethernet (FINS) using CX-One		Available	Available	After replacement, we do not recommend using this connection method to reduce security risks. To connect online with Ethernet network type setting, set the Unit to use FINS/UDP service. To connect online with Ethernet (FINS/TCP) network type setting, set the Unit to use FINS/TCP service.

*1. Both the source and target replacement models support opening and closing the port for the following services.

- FTP server and SNMP

Differences in Memory Allocation

The table below shows functions that differ in memory allocation between the C□1W-EIP21 and the C□1W-EIP21S. Refer to the *CS/CJ-series EtherNet/IP Units Operation Manual (Cat. No. W465)* for details on functions that differ.

CS: CS Series, CJ: CJ Series

Item	Source replacement model	Target replacement model	Effects of replacement
	C□1W-EIP21 (CS: CS1W-EIP21, CJ: CJ1W-EIP21)	C□1W-EIP21S (CS: CS1W-EIP21S, CJ: CJ1W-EIP21S)	

Allocated CIO Area words (CPU Bus Unit words)

User settings area	n+1 to n+4	Reserved	Socket Service Request Switches (CPU Unit to EtherNet/IP Unit)	When User defined is set for the layout of the allocated CIO Area words, socket service functions are added to the reserved area words of the source replacement model. Make sure that the reserved area words are not manipulated by the user program.
	n+16 to n+23	Reserved	UDP Socket No. □ Status and TCP Socket No. □ Status (EtherNet/IP Unit to CPU Unit)	
Unit Control Bits (CPU Unit to EtherNet/IP Unit) (n)	Bit 10	Reserved	Socket Force-close Switch (CPU Unit to EtherNet/IP Unit)	Socket service functions are added to the target replacement models. Make sure that the reserved bits are not manipulated by the user program.
Unit Status 2 (EtherNet/IP Unit to CPU Unit) (n+11)	Bit 10	Not used	User Authentication Setting Error (EtherNet/IP Unit to CPU Unit)	Functions are added to the target replacement models. Check the effects on the user program before replacement. Also, after replacement, change the program to monitor this bit.
	Bit 12 and Bit 13	Not used	Reserved	Functions are added to the target replacement models. Check the effects on the user program before replacement.

Allocated DM Area words (CPU Bus Unit words)

m+1 to m+8	Not used	Number of Bytes Received at TCP Socket No. □ (EtherNet/IP Unit to CPU Unit)	Socket service functions are added to the target replacement models. If the area words are used by the user program, the meaning of the data will change. Consider changing the data that was used before replacement to other available DM Area words.
m+9 to m+16	Not used	TCP Socket No. □ Connection Status (EtherNet/IP Unit to CPU Unit)	
m+17 to m+96	Not used	Socket Service Parameter Area □ (EtherNet/IP Unit to CPU Unit or CPU Unit to EtherNet/IP Unit)	

Restrictions

The table below shows restrictions on replacement.

Item	Description	Effects of replacement
Backup/ restoration	The C□1W-EIP21S has more data to back up than the C□1W-EIP21 due to the addition of security functions. It also has the same settings but different default values from those of the C□1W-EIP21.	You cannot restore the backup data from the C□1W-EIP21 to the C□1W-EIP21S if the simple backup function or PLC Backup Tool is used for backup. To do so, you need to use the CX-Programmer to reconfigure it to have the same settings as the source replacement model.
Power OFF detection time	Replacing the source replacement model with the C□1W-EIP21S may not allow you to set the power OFF detection time depending on the model of the Power Supply Unit in use.	If you need to set the power OFF detection time, replace the Power Supply Unit. For details, refer to 3-3-6 <i>Selecting the Power Supply Unit and Checking the Dimensions</i> on page 3-14.
Use restric- tion on the Power Sup- ply Unit	The CJ1W-EIP21S cannot be used with the CJ1W-PD022 Power Supply Unit.	If you use the Power Supply Unit mentioned on the left, change it to a different Power Supply Unit. For details, refer to 3-3-6 <i>Selecting the Power Supply Unit and Checking the Dimensions</i> on page 3-14.
Unit startup time	The startup time of the C□1W-EIP21S is longer than that of the C□1W-EIP21. For this reason, the CPU Unit startup time will be delayed by a few seconds compared with the system before replacement.	This means that you need to check the effects on the startup operation of the system.

3-2 Replacement Flow

This section describes the flow of replacing a system with the C□1W-EIP21. It consists of the flow of preparation and the flow of replacement.

3-2-1 Flow of Preparation

The table below shows the contents of preparation that you should make before replacement. Use this flow to plan a replacement and prepare data that matches the Unit configuration after replacement. Make the target replacement Unit available before replacement.

Step	Item	Description	Reference
1	Checking the Target Replacement Model	Check the target replacement model against the system configuration of the source replacement model. Check also the Support Software that supports the target replacement model.	3-3-1 <i>Checking the Target Replacement Model</i> on page 3-12
2	Checking the Differences in Specifications, Functions, Etc.	Check the differences in specifications, functions, etc. between the source and target replacement models, and the restrictions that apply, to determine the effects of replacement on the hardware, user program, and applications in the source replacement system.	3-3-2 <i>Checking the Differences in Specifications, Functions, Etc.</i> on page 3-12
3	Getting the Support Software	Get the Support Software that you will use for preparation and replacement.	3-3-3 <i>Getting the Support Software</i> on page 3-12
4	Reading and Saving Data	Read and save the following data from the source replacement system. You will use the data read in this step, and edit or set it in subsequent steps to match the target replacement system. <ul style="list-style-type: none"> • PLC project data • Tag data link parameters 	3-3-4 <i>Reading and Saving Data</i> on page 3-12
5	Creating an I/O Table	Create an I/O table to match the Unit configuration after replacement.	3-3-5 <i>Creating an I/O Table</i> on page 3-13
6	Selecting the Power Supply Unit and Checking the Dimensions	Check if it is necessary to change the Power Supply Unit in order to deal with the restrictions on the power supply that arise due to the replacement. If necessary, select an adequate Power Supply Unit. If, after the selection, you change the Power Supply Unit or expand the system, check the difference in the dimensions of the Unit configuration before and after replacement.	3-3-6 <i>Selecting the Power Supply Unit and Checking the Dimensions</i> on page 3-14
7	Setting Up the CPU Unit	Set up the CPU Unit in the Unit configuration after replacement.	3-3-7 <i>Setting Up the CPU Unit</i> on page 3-14
8	Setting Up the C□1W-EIP21S	Set up the C□1W-EIP21S in the Unit configuration after replacement.	3-3-8 <i>Setting Up the C□1W-EIP21S</i> on page 3-14
9	Editing the User Program	Edit the user program to deal with the differences in specifications due to the replacement and the restrictions that apply.	3-3-9 <i>Correcting the User Program</i> on page 3-14
10	Configuring Tag Data Links	Configure tag data links to match the Unit configuration after replacement.	3-3-10 <i>Configuring Tag Data Links</i> on page 3-14

3-2-2 Flow of Replacement

The table below shows the actual replacement steps that you should follow on completion of the preparation steps. You can implement security measures as needed after replacement.

Step	Item	Description	Reference
11	Replacing and Wiring Units	Replace Units according to the Unit configuration after replacement. Then, wire the replaced Units.	3-4-1 <i>Replacing and Wiring Units</i> on page 3-15
12	Turning ON the Power Supply	Turn ON the power supply to the PLC.	3-4-2 <i>Turning ON the Power Supply</i> on page 3-15
13	Transferring the I/O Table	If any of the following errors occur after the power supply is turned ON, transfer the created I/O table to the CPU Unit. To do so, connect the CX-Programmer directly to the CPU Unit.*1 <ul style="list-style-type: none"> • CPU Bus Unit setting error • I/O setting error (CJ Series) • I/O verification error (CS Series) 	3-4-3 <i>Transferring the I/O Table</i> on page 3-15
14	Transferring Data	From the Support Software connected directly to the CPU Unit, transfer the following data that you prepared to the actual PLC after replacement.*1 <ul style="list-style-type: none"> • PLC project data • Tag data link parameters 	3-4-4 <i>Transferring Data</i> on page 3-17
15	Checking the Operation	Confirm that the system operates as intended.	3-4-5 <i>Checking the Operation</i> on page 3-18
16	Implementing Security Measures*2	If necessary, implement measures to reduce the security risks from external attacks before the start of system operation after replacement. We recommend that you set user authentication and use secure communications (Secure Comm) to connect the Support Software online to the CJ1W-EIP21S EtherNet/IP port. In addition to user authentication and secure communications (Secure Comm), the CJ1W-EIP21S and Support Software provide other security functions to reduce security risks. Use these security functions in conjunction with system operation to further reduce the security risks.	3-4-6 <i>Implementing Security Measures</i> on page 3-19
17	Checking the Operation after Implementing Security Measures	After you implement security measures, check to be sure that the system operates according to the security settings.	3-4-7 <i>Checking the Operation after Implementing Security Measures</i> on page 3-19

*1. This means to connect Support Software directly to the USB port or peripheral port on the CPU Unit.

*2. Do this as needed.

3-3 Preparation

This section describes the preparation steps that you should follow before replacement.

3-3-1 Checking the Target Replacement Model

Check the target replacement model against the system configuration of the source replacement model. Check also the Support Software that supports the target replacement model.

For details, refer to *1-2-2 System with the C□1W-EIP21* on page 1-8.

3-3-2 Checking the Differences in Specifications, Functions, Etc.

Check the differences in specifications, functions, etc. between the source and target replacement models, and the restrictions that apply, to determine the effects of replacement on the hardware, user program, and applications in the source replacement system.

For details, refer to *3-1 Differences in Specifications, Functions, Etc.* on page 3-2.

3-3-3 Getting the Support Software

Get the Support Software that you will use for preparation and replacement. Specifically, get the CX-One version shown in *1-3 Support Software* on page 1-13 or higher.

All Support Software applications that you will use in the following sections are packaged in the CX-One.

3-3-4 Reading and Saving Data

Read and save the following data from the source replacement system.

You will use the data read in this step, and edit or set it in subsequent steps to match the target replacement system.

- PLC project data
- Tag data link parameters

Perform this operation so that you can restore the data from the source replacement system. Even when you have the data in the source replacement system, there is a risk of trouble if it is different from the data in the actual PLC. We recommend that you read and save it.

Read and save the PLC project data and tag data link parameters from the source replacement PLC according to *2-3-4 Reading and Saving Data* on page 2-19. Note that, for the PLC project data, read and save the following data in this case of replacement.

- User program
- PLC settings
- I/O table
- Special Unit settings
- DM Area information

3-3-5 Creating an I/O Table

Create an I/O table to match the Unit configuration after replacement.

Use the CX-Programmer and open the I/O table for the PLC project data for the source replacement model. Then, in the I/O table, change the source replacement Unit to the target replacement Unit.

The following shows how to create an I/O table with the CX-Programmer. Refer to the *CX-Programmer Ver. 9.□ Operation Manual (Cat. No. W446)* in addition to this manual for how to operate the CX-Programmer.

- 1 Use the CX-Programmer and open the I/O table for the PLC project data from the source replacement model.
- 2 In the IO Table Dialog Box, right-click the source replacement model C□1W-EIP21 and select **Change / Confirm Units** from the menu to change it to the target replacement model C□1W-EIP21S. Or, right-click the C□1W-EIP21 and select **Add Unit** to change the Unit to the C□1W-EIP21S.

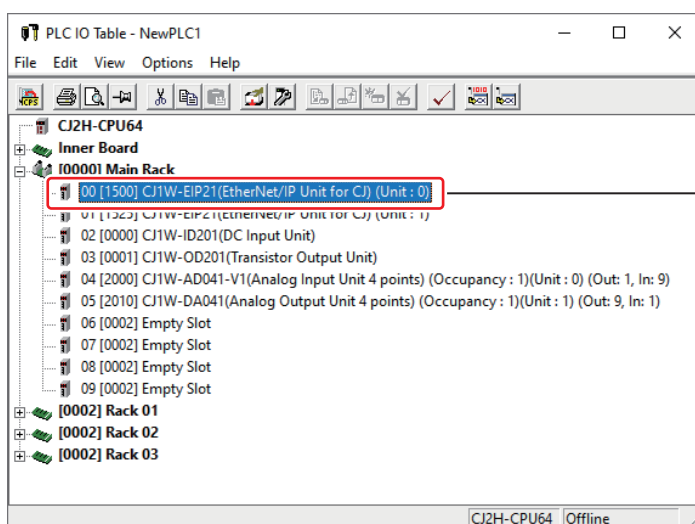

Change the model to CJ1W-EIP21S.

- 3 Repeat step 2 to create an I/O table for the Unit configuration after replacement.

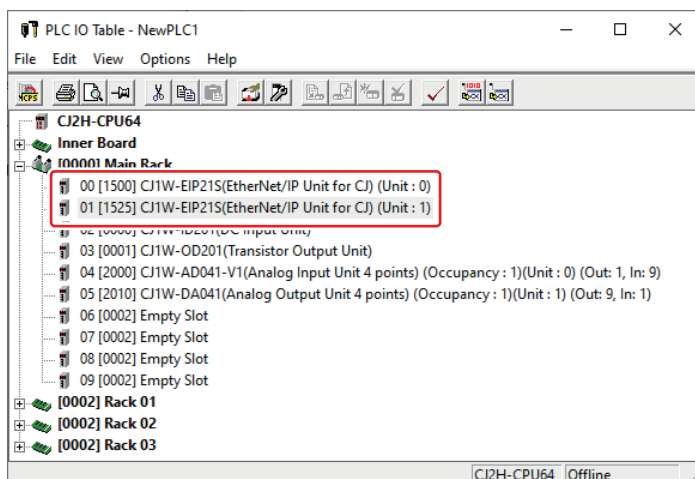



Precautions for Correct Use

The CS Series operates only when the I/O table is registered in the CPU Unit. Be sure to create an I/O table and transfer it to the CPU Unit.

3-3-6 Selecting the Power Supply Unit and Checking the Dimensions

Check if it is necessary to change the Power Supply Unit in order to deal with the restrictions on the power supply that arise due to the replacement. If necessary, select an adequate Power Supply Unit. If, after the selection, you change the Power Supply Unit or expand the system, check the difference in the dimensions of the Unit configuration before and after replacement.

Select the Power Supply Unit and check the dimensions according to *2-3-7 Selecting the Power Supply Unit and Checking the Dimensions* on page 2-32.

3-3-7 Setting Up the CPU Unit

After you create an I/O table, set up the CPU Unit in the Unit configuration after replacement.

Use the CX-Programmer to edit the PLC settings.

In this case of replacement, configure the following settings in the PLC Settings Window as required to deal with the restrictions on replacement.

- **Power Off Detection Time**

Set this according to *Dealing with Restrictions* on page 2-37 in *2-3-8 Setting Up the CPU Unit* on page 2-36.

3-3-8 Setting Up the C□1W-EIP21S

After you create an I/O table, set up the C□1W-EIP21S in the Unit configuration after replacement.

Use the CX-Programmer and configure the C□1W-EIP21S parameters in the Unit Setup from the I/O table. Configure the settings to match those of the source replacement model.

Refer to *2-3-9 Setting Up the C□1W-EIP21S* on page 2-38 for the configuration.

3-3-9 Correcting the User Program

Correct the user program to deal with the differences in specifications due to the replacement and the restrictions that apply. Refer to *3-1 Differences in Specifications, Functions, Etc.* on page 3-2 for differences that affect the user program among those from the source replacement model.

For the C□1W-EIP21S, socket service functions are assigned to reserved and unused bits of the allocated CIO Area and DM Area words. If, in the source replacement model, the reserved or unused bits are used by a program, the program needs to be corrected.

After you correct the user program, save the PLC project data.

3-3-10 Configuring Tag Data Links

Configure tag data links to match the Unit configuration after replacement. There is no need to reconfigure them from scratch. Use the Network Configurator and execute the Change Device Type function on the network configuration file for the source replacement model to change the source replacement model to the C□1W-EIP21S.

Refer to *2-3-13 Configuring Tag Data Links* on page 2-44 for the configuration.

3-4 Replacement

This section describes the actual replacement steps.

3-4-1 Replacing and Wiring Units

Replace and wire Units. Refer to the user's manual for the target replacement Unit for the hardware setup, installation, and wiring of each Unit.

Taking into account the risk that you fail in replacement, perform simple backup with a Memory Card, or back up the PLC data with the PLC Backup Tool.

Replacing Units

Replace each Unit with the power supply turned OFF.

- **C□1W-EIP21**

Configure the hardware settings of the C□1W-EIP21S, i.e., the unit number and node address (default IP address), to match those of the source replacement model C□1W-EIP21.

After this, replace the Unit.

- **Other Units**

If you have Units to replace other than the C□1W-EIP21S, replace them.

For example, replace the Power Supply Unit, Expansion Rack, etc.

Wiring the Units

After replacement, wire the Units.

However, leave the Ethernet cable to the C□1W-EIP21S disconnected at this point.

3-4-2 Turning ON the Power Supply

Turn ON the power supply to the PLC after replacement.



Precautions for Correct Use

The C□1W-EIP21S requires a Unit startup time. For this reason, the CPU Unit startup time will be delayed by a few seconds compared with the system before replacement.

3-4-3 Transferring the I/O Table

If any of the following errors occur after the power supply to the PLC is turned ON, transfer the I/O table for the Unit configuration after replacement, which you created in *3-3-5 Creating an I/O Table* on page 3-13, to the PLC.

- CPU Bus Unit setting error
- I/O setting error (CJ Series)

- I/O verification error (CS Series)

To do so, connect the CX-Programmer directly to the USB port, peripheral port, etc. on the CPU Unit and place it online. At this point, you do not need to transfer the Special Unit settings. You will transfer them later in *3-4-4 Transferring Data* on page 3-17.

On completion of the transfer, the above errors are removed because the I/O table that matches the actual configuration after replacement is registered in the CPU Unit.



Precautions for Correct Use

The CS Series operates only when the I/O table is registered in the CPU Unit.

Transferring the I/O Table

Follow the steps below to transfer the I/O table.

Refer to the *CX-Programmer Ver. 9.□ Operation Manual (Cat. No. W446)* in addition to this manual for how to operate the CX-Programmer and connect the CPU Unit to the CX-Programmer. Refer also to the user's manual for your CPU Unit for how to connect the CPU Unit to the CX-Programmer.

- 1** Connect the CPU Unit and the computer with a Support Software connection cable, etc.
- 2** Start the CX-Programmer.
- 3** Connect the CX-Programmer online to the PLC and change to PROGRAM mode.
PLC – Work Online
PLC – Operating Mode – Program
- 4** Transfer the I/O table to the PLC.
PLC – Transfer – To PLC

- (1) Select the IO table Check Box. (2) Click the **OK** Button.

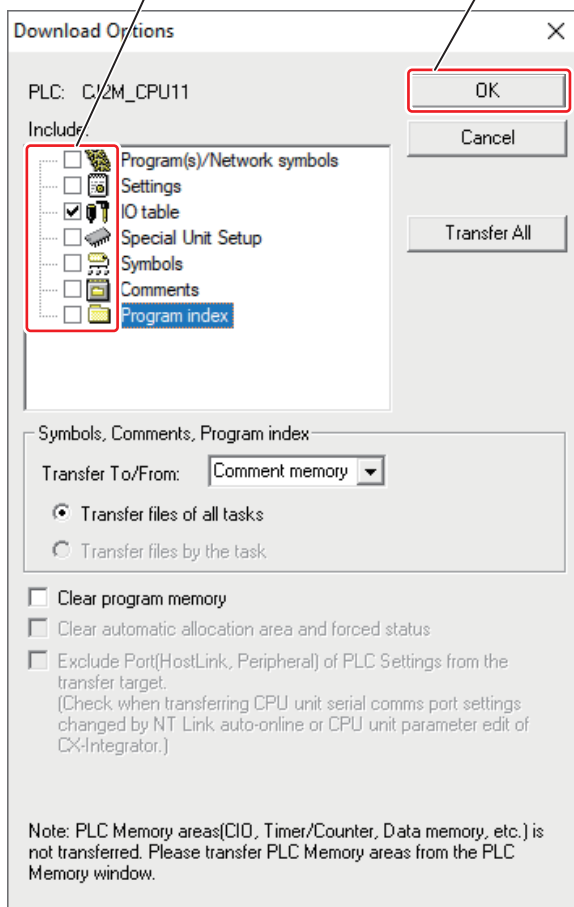

3-4-4 Transferring Data

From the Support Software connected directly to the CPU Unit, transfer the following data that you prepared to the actual PLC after replacement. *1

- PLC project data
- Tag data link parameters

*1. This means to connect Support Software directly to the USB port or peripheral port on the CPU Unit.



Precautions for Correct Use

The C□1W-EIP21S has additional security functions, by which you can disable the EtherNet/IP port. Disabling the EtherNet/IP port accidentally prevents you from connecting the Support Software online.

Therefore, during replacement, connect the Support Software directly to the USB port, peripheral port, etc. on the CPU Unit and place it online with the PLC to allow for data transfer.

The table below shows the flow of data transfer to the actual PLC. Use this flow to transfer data.

Step	Item	Description	Reference
1	Transferring PLC Project Data	Transfer PLC project data to the CPU Unit for each PLC after replacement.	<i>Transferring PLC Project Data (to PLC)</i> on page 3-18

Step	Item	Description	Reference
2	Connecting Communications Cables	Turn OFF the power supply to each PLC. Then, connect communications cables to the target replacement model C□1W-EIP21S.	---
3	Turning ON the Power Supply to Each PLC	Check the safety of the equipment and turn ON the power supply to each PLC.	---
4	Downloading Tag Data Link Parameters	Download all tag data link parameters for each EtherNet/IP network.	<i>Downloading Tag Data Link Parameters</i> on page 3-18

Transferring PLC Project Data (to PLC)

Transfer the PLC project data that you created to match the Unit configuration after replacement during preparation to the actual PLC. To do so, connect the CX-Programmer directly to the USB port, peripheral port, etc. on the CPU Unit and place it online.

The following is the PLC project data to transfer. Note that there is no need to transfer data that was not edited during preparation.

- User program
- PLC settings
- I/O table
- Special Unit settings
- DM Area information

Transfer PLC project data according to *Transferring PLC Project Data (to PLC)* on page 2-49 in *2-4-3 Transferring Data* on page 2-49.

If you transfer the I/O table due to occurrence of the following errors after the power supply to the PLC is turned ON, there is no need to transfer the I/O table at this point.

- CPU Bus Unit setting error
- I/O setting error (CJ Series)
- I/O verification error (CS Series)

Downloading Tag Data Link Parameters

This data is available when you use tag data links in the source replacement model. Download the tag data link settings that you created to match the Unit configuration after replacement during preparation to the actual PLC.

Refer to *Downloading Tag Data Link Parameters* on page 2-55 in *2-4-3 Transferring Data* on page 2-49 for how to download the settings.

3-4-5 Checking the Operation

After you transfer data, use the CX-Programmer to check that the system is operating as intended. Check also that no error occurs according to the specified error check procedure for each Unit. Refer to the user's manual for your Unit for the operation check and troubleshooting procedures for each Unit.

3-4-6 Implementing Security Measures

If necessary, implement measures to reduce the security risks from external attacks before the start of system operation after replacement. We recommend that you set user authentication and use secure communications (Secure Comm) to connect the Support Software online to the C□1W-EIP21S EtherNet/IP port.

In addition to user authentication and secure communications (Secure Comm), the C□1W-EIP21S and Support Software provide other security functions to reduce security risks. Use these security functions in conjunction with system operation to further reduce the security risks.

For details, refer to *2-4-5 Implementing Security Measures* on page 2-55.

3-4-7 Checking the Operation after Implementing Security Measures

After you implement security measures, check to be sure that the system operates according to the security settings.

4

Replacing a System with the C□1W-ETN21

This section describes the replacement flow and replacement procedures for a system with the C□1W-ETN21.

4

4-1	Differences and Changes in Specifications and Functions	4-2
4-1-1	Differences in Specifications and Functions	4-2
4-1-2	Changes during Replacement	4-4
4-2	Replacement Flow	4-6
4-2-1	Flow of Preparation	4-6
4-2-2	Flow of Replacement	4-7
4-3	Preparation	4-9
4-3-1	Checking the Target Replacement Model	4-9
4-3-2	Checking the Differences in Specifications, Functions, Etc.	4-9
4-3-3	Getting the Support Software	4-9
4-3-4	Reading and Saving Data	4-9
4-3-5	Creating an I/O Table	4-10
4-3-6	Selecting the Power Supply Unit and Checking the Dimensions	4-10
4-3-7	Configuring Special Unit Settings	4-11
4-3-8	Editing PLC Settings	4-19
4-3-9	Editing the User Program	4-20
4-3-10	Editing Allocated CIO Area or DM Area Words	4-26
4-3-11	Saving the Project File	4-27
4-4	Replacement	4-28
4-4-1	Replacing and Wiring Units	4-28
4-4-2	Turning ON the Power Supply	4-28
4-4-3	Transferring the I/O Table	4-28
4-4-4	Transferring Data (to PLC)	4-30
4-4-5	Checking the Operation	4-30
4-4-6	Implementing Security Measures	4-30
4-4-7	Checking the Operation after Implementing Security Measures	4-30

4-1 Differences and Changes in Specifications and Functions

This section describes the differences in specifications and functions between the source replacement model (C□1W-ETN21) and the target replacement model (C□1W-EIP21S), and the changes to be made during replacement.

4-1-1 Differences in Specifications and Functions

The table below shows the differences in specifications and functions between the source replacement model (C□1W-ETN21) and the target replacement model (C□1W-EIP21S).

Yes: Supported, No: Not supported

Item	Source replacement model	Target replacement model	Effects of replacement
	CJ1W-ETN21 CS1W-ETN21	CJ1W-EIP21S CS1W-EIP21S	
Tag data link communications service	No	Yes	There is no effect.
CIP message communications service	No	Yes	There is no effect.
FINS/UDP service	Yes	Yes	To use this service, set Use FINS/UDP service .
FINS/TCP service	Yes	Yes	To use this service, set Use FINS/TCP service .
Keep-alive	Yes	Yes	The default keep-alive value is different. Change the default value, if used, to 120 min.
Socket service	Yes	Yes	Edit the user program and allocated CIO Area or DM Area words.
File transfer (FTP)	Yes	Yes	To use this service, set Use FTP . Set the user name and password.
Mail send/receive	Yes	No	Mail send/receive is not available.
Web functions	Yes	No	Web functions are not available.
Automatic adjustment of PLC's internal clock	Yes	Yes	To use this service, set Get the time information from the SNTP server .
Security	No	Yes	We recommend using these functions to reduce security risks, if necessary. To use these functions, configure the settings.
Simple backup function	Yes	Yes	You cannot restore backup data from the C□1W-ETN21 to the C□1W-EIP21S.
Error log	Yes	Yes	There is no effect.
Response to PING command	Yes	Yes	There is no effect.
SNMP/SNMP trap	No	Yes	There is no effect.
CIDR function for IP addresses	Yes	Yes	This is fixed to <i>Enable CIDR</i> .

Item	Source replacement model	Target replacement model	Effects of replacement
	CJ1W-ETN21 CS1W-ETN21	CJ1W-EIP21S CS1W-EIP21S	
Online connection by EtherNet/IP using CX-One	No	Yes	After replacement, we do not recommend using this connection method to reduce security risks.
Online connection by Ethernet (FINS) using CX-One	Yes	Yes	After replacement, we do not recommend using this connection method to reduce security risks. To connect online with Ethernet network type setting, you should set the Unit to use FINS/UDP service. To connect online with Ethernet (FINS/TCP) network type setting, you should set the Unit to use FINS/TCP service.
Online connection from CX-One to CPU Unit via EtherNet/IP port with secure communications	No	Yes	After replacement, we recommend using these functions to reduce security risks. To use this function, configure the settings.
Online connection by EtherNet/IP using Network Configurator	No	Yes	There is no effect.
Monitoring Unit Control Bits with CX-Programmer	Yes	No	You cannot monitor Unit Control Bits with the CX-Programmer.
Layout of allocated CIO Area and DM Area words	---	---	Edit the user program because the addresses and bit configuration are different.
Current consumption (5 VDC)	CJ: 370 mA CS: 380 mA	CJ: 650 mA CS: 620 mA	The current consumption increases.
Use restriction on the Power Supply Unit	---	---	The following restrictions apply to the target replacement model. Check if changing the Power Supply Unit is necessary depending on the amount of increase in current consumption. <ul style="list-style-type: none"> The CJ1W-PD022 cannot be used. Restrictions on the Power Supply Unit with or without the power OFF detection time
Unit startup time	---	---	The target replacement model has a longer Unit startup time. For this reason, the CPU Unit startup time will be delayed by a few seconds compared with the system before replacement. This means that you need to check the effects on the startup operation of the system.

4-1-2 Changes during Replacement

The table below shows the changes to be made for each item during replacement.

All of these settings are configured with the CX-Programmer.

Yes: Change required, No: Change not required

Item	User program	Allocated DM Area words	Special Unit settings	PLC settings	I/O table	Changes to be made during replacement
Replacing Units (from C□1W-ETN21 to C□1W-EIP21S)	Yes (a)	Yes (b)	Yes (c)	No	Yes (d)	(a) Edit the allocated CIO Area or DM Area words. (b) Change the set data. (c) Reconfigure the settings to match those of the target replacement model. (d) Change the Unit to the target replacement model.
FINS/UDP service	No	No	Yes	No	No	Set Use FINS/UDP service .
FINS/TCP service	No	No	Yes	No	No	Set Use FINS/TCP service .
Keep-alive	No	No	Yes	No	No	The default keep-alive value is different. Change the default value, if used, to 120 min.
Socket service	Yes (e)	Yes (f)	Yes (g)	No	No	(e) Edit the allocated CIO Area or DM Area words. In addition, the fragment size of TCP transmission data changes as below. <ul style="list-style-type: none"> C□1W-ETN21: 1,024 bytes C□1W-EIP21S: 1,460 bytes Check the impact on the user program at the receive side. (f) Move the data to the changed address if directly reflected in the DM Area. (g) Specify a consecutive 64 words of unused area in the Status Area Tab Page.
File transfer (FTP)	No	No	Yes	No	No	Set Use FTP . Set the login name and password.
Automatic adjustment of PLC's internal clock	Yes (h)	No	Yes (i)	No	No	(h) Edit the allocated CIO Area or DM Area words. (i) Set Get the time information from the SNTP server .
Online connection by Ethernet (FINS) using CX-One	No	No	Yes	No	No	To connect online with Ethernet network type setting, you should set the Unit to use FINS/UDP service. To connect online with Ethernet (FINS/TCP) network type setting, you should set the Unit to use FINS/TCP service.

Item	User program	Allocated DM Area words	Special Unit settings	PLC settings	I/O table	Changes to be made during replacement
Current consumption	No	No	No	No	Yes	After you change the I/O table, check the current consumption. If necessary, change the Power Supply Unit or change the Unit configuration.
Use restriction on the Power Supply Unit	No	No	No	Yes	No	To disable the power OFF detection time after considering the restrictions, set 0 ms.

4-2 Replacement Flow

This section describes the replacement flow for a system with the Ethernet Unit CJ1W-ETN21 or CS1W-ETN21. It consists of the flow of preparation and the flow of replacement.

4-2-1 Flow of Preparation

The table below shows the contents of preparation that you should make before replacement. Use this flow to plan a replacement and prepare data that matches the Unit configuration after replacement. Make the target replacement Unit available before replacement.

Step	Item	Description	Reference
1	Checking the Target Replacement Model	Check the target replacement model against the system configuration of the source replacement model. Check also the Support Software that supports the target replacement model.	<i>4-3-1 Checking the Target Replacement Model</i> on page 4-9
2	Checking the Differences in Specifications, Functions, Etc.	Check the differences in specifications, functions, etc. between the source and target replacement models to determine the effects of replacement on the hardware, user program, and applications in the source replacement system.	<i>4-3-2 Checking the Differences in Specifications, Functions, Etc.</i> on page 4-9
3	Getting the Support Software	Get the Support Software that you will use for preparation and replacement.	<i>4-3-3 Getting the Support Software</i> on page 4-9
4	Reading and Saving Data	Read and save the following data from the source replacement system. You will use the data read in this step, and edit or set it in subsequent steps to match the target replacement system. <ul style="list-style-type: none"> PLC project data 	<i>4-3-4 Reading and Saving Data</i> on page 4-9
5	Creating an I/O Table	Create an I/O table to match the Unit configuration after replacement.	<i>4-3-5 Creating an I/O Table</i> on page 4-10
6	Selecting the Power Supply Unit and Checking the Dimensions	Check if it is necessary to change the Power Supply Unit in order to deal with the restrictions on the power supply that arise due to the replacement. If necessary, select an adequate Power Supply Unit. If, after the selection, you change the Power Supply Unit or expand the system, check the difference in the dimensions of the Unit configuration before and after replacement.	<i>4-3-6 Selecting the Power Supply Unit and Checking the Dimensions</i> on page 4-10
7	Configuring Special Unit Settings	Configure the Special Unit settings for the target replacement model to match those of the source replacement model.	<i>4-3-7 Configuring Special Unit Settings</i> on page 4-11
8	Editing PLC Settings	Configure the following settings as required to deal with the restrictions on replacement. <ul style="list-style-type: none"> Power OFF detection time 	<i>4-3-8 Editing PLC Settings</i> on page 4-19
9	Editing the User Program	Because the addresses and bit configuration of the allocated CIO Area and DM Area words are changed, change the addresses and bit positions of these areas used by the user program.	<i>4-3-9 Editing the User Program</i> on page 4-20

Step	Item	Description	Reference
10	Editing Allocated CIO Area or DM Area Words	Edit the allocated CIO Area or DM Area words of the source replacement model that data is written to or read from to match the corresponding area words in the target replacement model.	4-3-10 <i>Editing Allocated CIO Area or DM Area Words</i> on page 4-26
11	Saving the Project File	Save the data that you edited.	4-3-11 <i>Saving the Project File</i> on page 4-27

4-2-2 Flow of Replacement

The table below shows the actual replacement steps that you should follow on completion of the preparation steps. You can implement security measures as needed after replacement.

Step	Item	Description	Reference
12	Replacing and Wiring Units	Replace Units according to the Unit configuration after replacement. Then, wire the replaced Units.	4-4-1 <i>Replacing and Wiring Units</i> on page 4-28
13	Turning ON the Power Supply	Turn ON the power supply to the PLC.	4-4-2 <i>Turning ON the Power Supply</i> on page 4-28
14	Transferring the I/O Table	If any of the following errors occur after the power supply is turned ON, transfer the created I/O table to the CPU Unit. To do so, connect the CX-Programmer directly to the CPU Unit.*1 <ul style="list-style-type: none"> • CPU Bus Unit setting error • I/O setting error (CJ Series) • I/O verification error (CS Series) 	4-4-3 <i>Transferring the I/O Table</i> on page 4-28
15	Transferring Data	Write data that you edited during preparation to the PLC.	4-4-4 <i>Transferring Data (to PLC)</i> on page 4-30
16	Checking the Operation	Confirm that the system operates as intended.	4-4-5 <i>Checking the Operation</i> on page 4-30
17	Implementing Security Measures*2	If necessary, implement measures to reduce the security risks from external attacks before the start of system operation after replacement. We recommend that you set user authentication and use secure communications (Secure Comm) to connect the Support Software online to the C□1W-EIP21S EtherNet/IP port. In addition to user authentication and secure communications (Secure Comm), the C□1W-EIP21S and Support Software provide other security functions to reduce security risks. Use these security functions in conjunction with system operation to further reduce the security risks.	4-4-6 <i>Implementing Security Measures</i> on page 4-30
18	Checking the Operation after Implementing Security Measures	After you implement security measures, check to be sure that the system operates according to the security settings.	4-4-7 <i>Checking the Operation after Implementing Security Measures</i> on page 4-30

*1. This means to connect Support Software directly to the USB port or peripheral port on the CPU Unit.

*2. Do this as needed.

4-3 Preparation

This section describes the preparation steps that you should follow before replacement.

4-3-1 Checking the Target Replacement Model

Check the target replacement model against the system configuration of the source replacement model. Check also the Support Software that supports the target replacement model.

For details, refer to *1-2-3 System with the C□1W-ETN21* on page 1-9.

4-3-2 Checking the Differences in Specifications, Functions, Etc.

Check the differences in specifications, functions, etc. between the source and target replacement models to determine the effects of replacement on the hardware, user program, and applications in the source replacement system.

For details, refer to *4-1 Differences and Changes in Specifications and Functions* on page 4-2.

4-3-3 Getting the Support Software

Get the Support Software that you will use for preparation and replacement. Specifically, get the CX-One version shown in *1-3 Support Software* on page 1-13 or higher.

All Support Software applications that you will use in the following sections are packaged in the CX-One.

4-3-4 Reading and Saving Data

Read and save the following data from the source replacement system.

You will use the data read in this step, and edit or set it in subsequent steps to match the target replacement system.

Data	Description	Reference
PLC project data*1	This data includes the user program, PLC settings, I/O table, Special Unit settings, and DM Area information. Use the CX-Programmer to read it.	<i>Reading PLC Project Data (from PLC)</i> on page 4-9

*1. This data is stored in the CX-Programmer project file. In this manual, it is referred to as PLC project data.

Perform this operation so that you can restore the data from the source replacement system. Even when you have the data in the source replacement system, there is a risk of trouble if it is different from the data in the actual PLC. We recommend that you read and save it.

Reading PLC Project Data (from PLC)

Use the CX-Programmer to read and save the following project data from the source replacement PLC.

- User program
- PLC settings
- I/O table

- Special Unit settings
- DM Area information

Refer to *Reading and Saving PLC Project Data* on page 2-20 in *2-3-4 Reading and Saving Data* on page 2-19 for how to read and save the above data from the PLC.

4-3-5 Creating an I/O Table

Create an I/O table to match the Unit configuration after replacement.

Use the CX-Programmer and open the I/O table for the PLC project data for the source replacement model. Then, in the I/O table, change the source replacement Unit to the target replacement Unit.

The following shows how to create an I/O table with the CX-Programmer. Refer to the *CX-Programmer Ver. 9.□ Operation Manual (Cat. No. W446)* in addition to this manual for how to operate the CX-Programmer.

- 1 Use the CX-Programmer and open the I/O table for the PLC project data from the source replacement model.
- 2 In the IO Table Dialog Box, right-click the source replacement model C□1W-ETN21 and select **Change / Confirm Units** from the menu to change it to the target replacement model C□1W-EIP21S. Or, right-click the C□1W-ETN21 and select **Add Unit** to change the Unit to the C□1W-EIP21S.

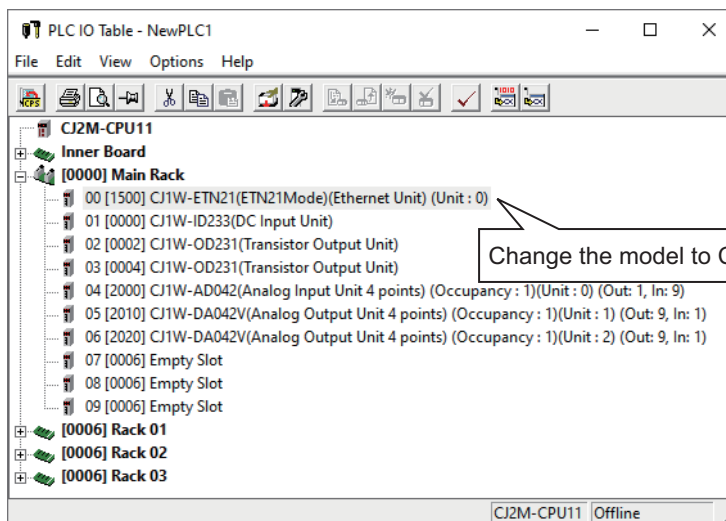

- 3 Repeat step 2 to create an I/O table for the Unit configuration after replacement.



Precautions for Correct Use

The CS Series operates only when the I/O table is registered in the CPU Unit. Be sure to create an I/O table and transfer it to the CPU Unit.

4-3-6 Selecting the Power Supply Unit and Checking the Dimensions

Check if it is necessary to change the Power Supply Unit in order to deal with the restrictions on the power supply that arise due to the replacement. If necessary, select an adequate Power Supply Unit.

If, after the selection, you change the Power Supply Unit or expand the system, check the difference in the dimensions of the Unit configuration before and after replacement.

Select the Power Supply Unit and check the dimensions according to 2-3-7 *Selecting the Power Supply Unit and Checking the Dimensions* on page 2-32.

4-3-7 Configuring Special Unit Settings

In the CX-Programmer, configure the Special Unit settings for the target replacement model C□1W-EIP21S to match those of the source replacement model C□1W-ETN21.

However, you cannot perform this operation automatically. Manually move the Special Unit settings that you read from the C□1W-ETN21 in 4-3-4 *Reading and Saving Data* on page 4-9 to the C□1W-EIP21S.

The following topics describe how to move these settings.

Note The setting tab pages for the C□1W-ETN21 shown here are for unit version 1.5 and in ETN21 mode. Except for the model description, the contents of the ETN21 setting tab pages for CJ1 and CS1 are the same. Refer to the *Ethernet Units Operation Manual Construction of Networks (Cat. No. W420)* for the setting tab pages for other unit versions and modes.

Moving the Settings from the Setting Tab Page

Move the settings from the **Setting** Tab Page for the C□1W-ETN21 to the corresponding locations in the specified tab page for the C□1W-EIP21S as shown below.

● Setting Tab Page to TCP/IP Tab Page

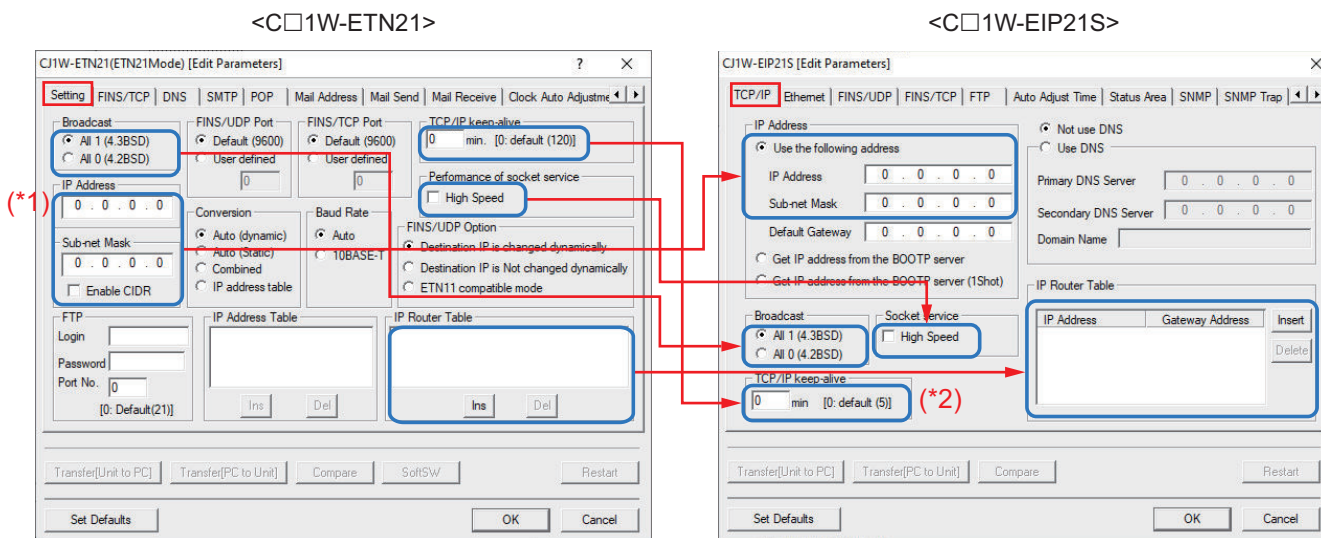

(*1) If the IP address is all zeros, it means that the data is set in the DM Area.

Check that the data read in the DM Area is correct.

(*2) The default keep-alive value is different. Change the default value, if used, to 120 min. Enter 120.

● Setting Tab Page to Ethernet Tab Page

<C□1W-ETN21>

<C□1W-EIP21S>

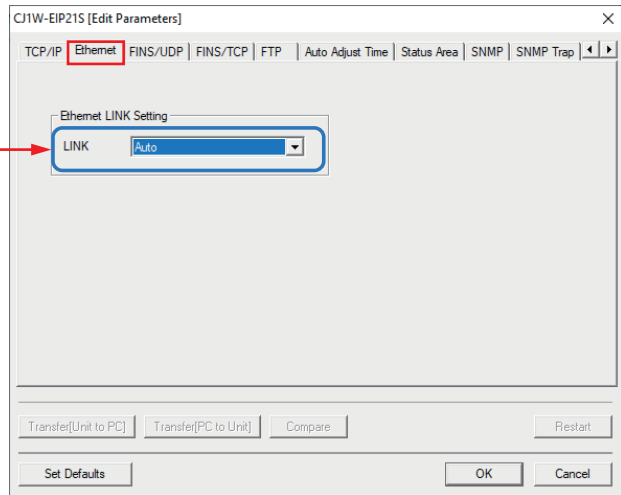
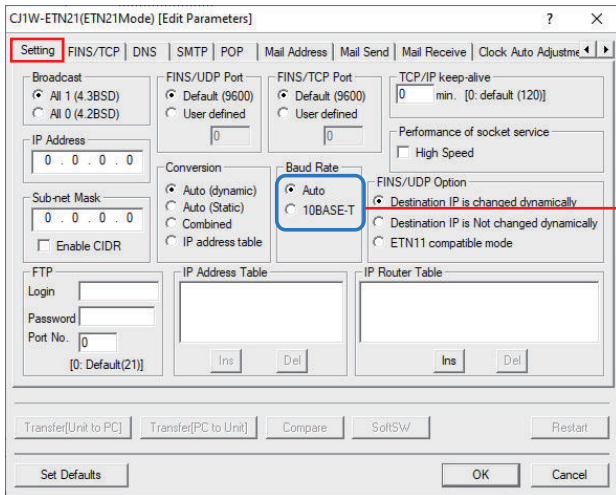

● Setting Tab Page to FINS/UDP Tab Page

<C□1W-ETN21>

<C□1W-EIP21S>

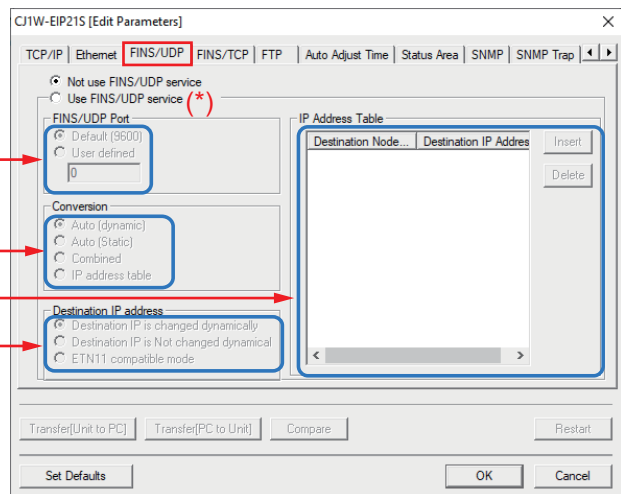
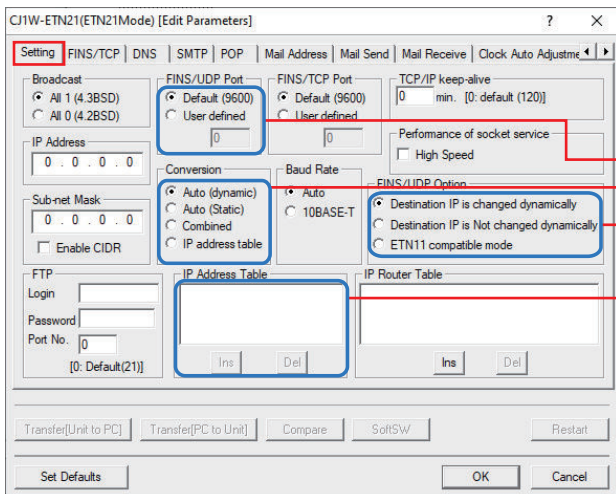

(*) The source replacement model does not have the settings for using or not using the FINS/UDP service and, by default, you can use this service. Therefore, select the **Use FINS/UDP service** Check Box.

● Setting Tab Page to FINS/TCP Tab Page

<C□1W-ETN21>

<C□1W-EIP21S>

(*) The source replacement model does not have the settings for using or not using the FINS/TCP service and, by default, you can use this service. Therefore, select the **Use FINS/TCP service** Check Box.

● Setting Tab Page to FTP Tab Page

<C□1W-ETN21>

<C□1W-EIP21S>

(*) To use FTP, select the **Use FTP** Check Box. Always set the login and password information. For the C□1W-ETN21, this is set by default as follows.

- Login: CONFIDENTIAL
- Password: Blank

Although you can leave the password blank for the C□1W-ETN21, the password setting is required for the C□1W-EIP21S. Set any password. Note that, for the C□1W-EIP21S, the login name is 1 to 16 characters and the password is 8 to 16 characters in length. The entered password characters are replaced by asterisks.

● No Settings to Move from the Setting Tab Page

For the C□1W-EIP21S, the following setting is not provided. The CIDR function is always enabled.

Even if CIDR is not enabled for the C□1W-ETN21, the IP address of the C□1W-EIP21S after replacement does not change.

<C□1W-ETN21>

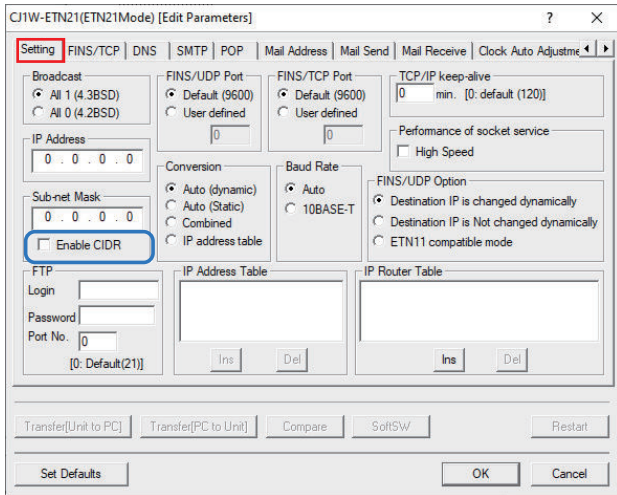

<C□1W-EIP21S>

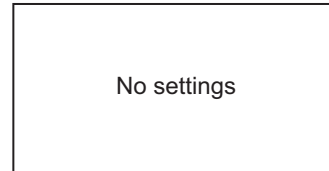

Moving the Settings from the FINS/TCP Tab Page

Move the settings from the **FINS/TCP** Tab Page for the C□1W-ETN21 to the corresponding locations in the specified tab page for the C□1W-EIP21S as shown below.

<C□1W-ETN21>

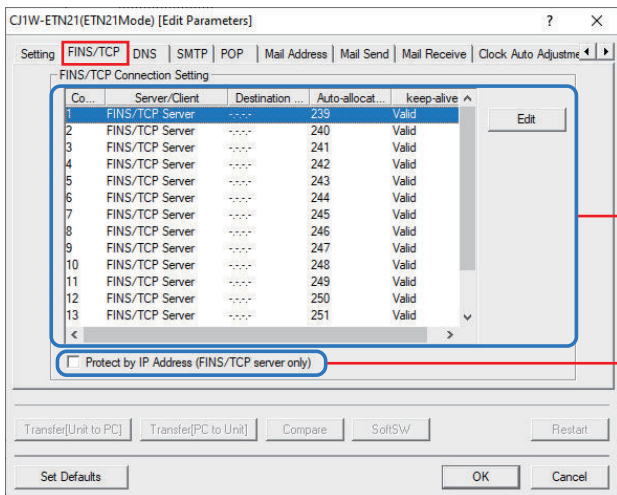

<C□1W-EIP21S>

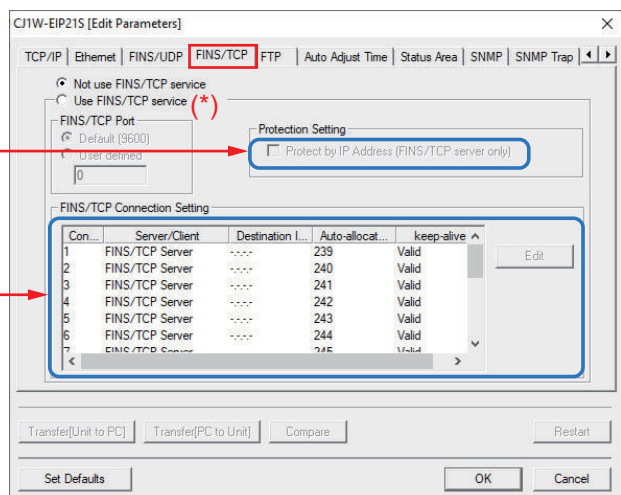

(*) The source replacement model does not have the settings for using or not using the FINS/TCP service and, by default, you can use this service. Therefore, select the **Use FINS/TCP service** Check Box.

Moving the Settings from the DNS Tab Page

Move the settings from the **DNS** Tab Page for the C□1W-ETN21 to the corresponding locations in the specified tab page for the C□1W-EIP21S as shown below.

● DNS Tab Page to TCP/IP Tab Page

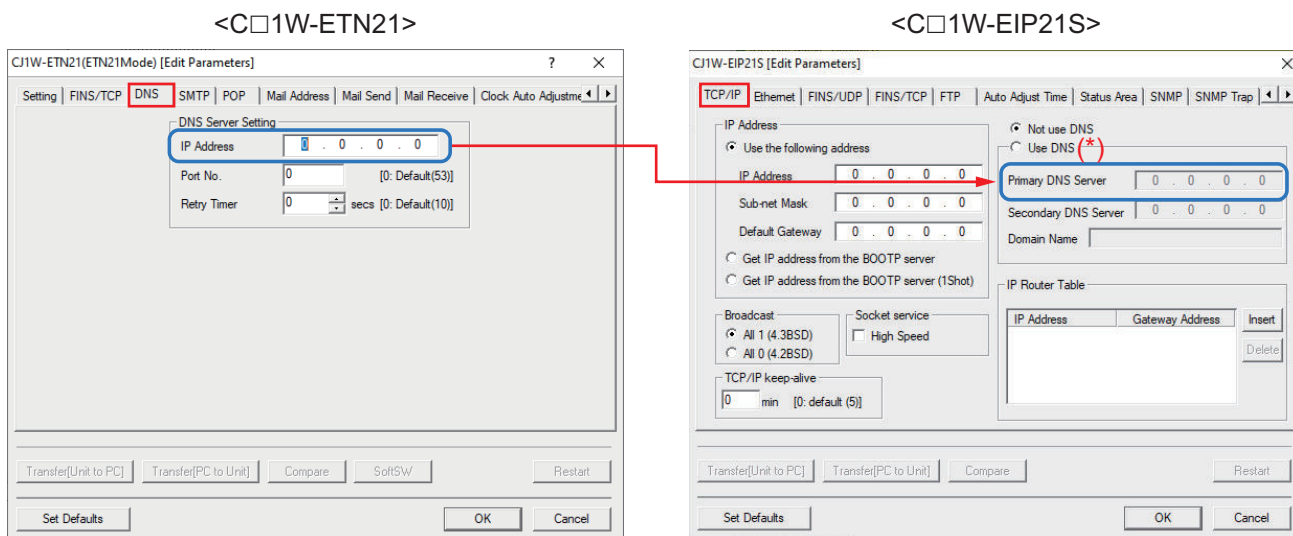

(*) To use a DNS server, select the **Use DNS** Check Box.

● No Settings to Move from the DNS Tab Page

For the C□1W-EIP21S, the following setting is not provided. The Port No. is set to 53. The Retry Timer is set to a fixed value.

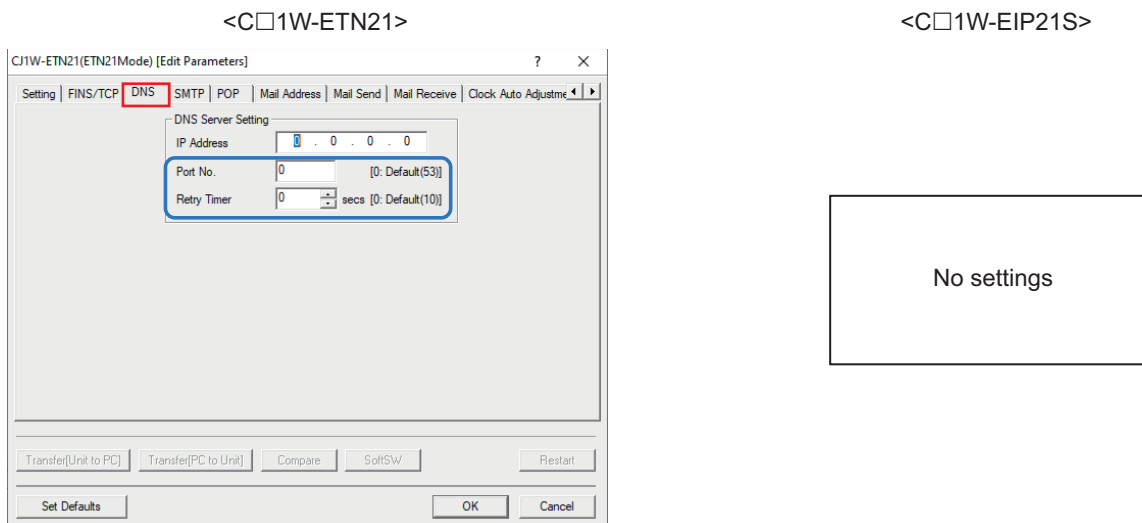

Moving the Settings from the SMTP Tab Page

Because the C□1W-EIP21S does not support the mail functions, you cannot move the settings from the C□1W-ETN21's **SMTP** Tab Page.

<C□1W-ETN21>

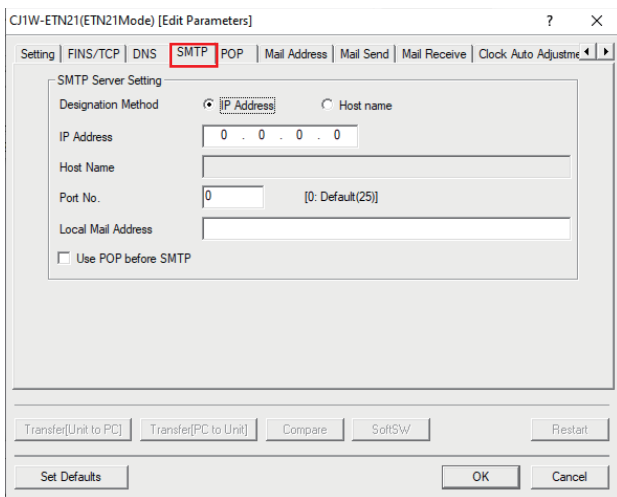

<C□1W-EIP21S>

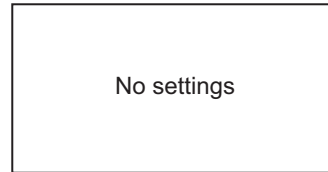

Moving the Settings from the POP Tab Page

Because the C□1W-EIP21S does not support the mail functions, you cannot move the settings from the C□1W-ETN21's **POP** Tab Page.

<C□1W-ETN21>

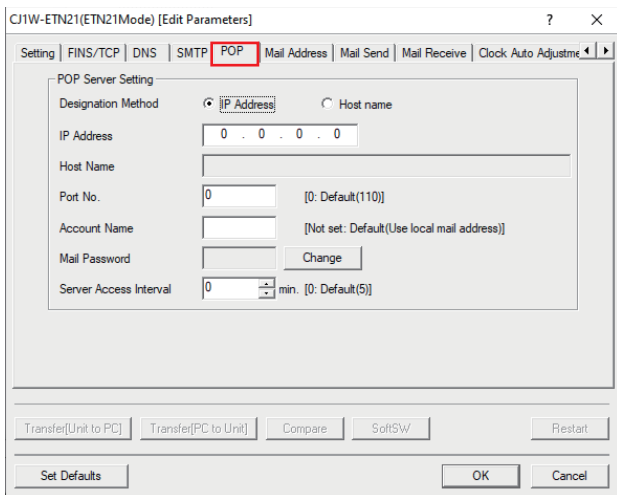

<C□1W-EIP21S>

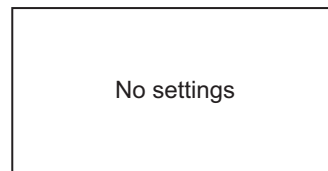

Moving the Settings from the Mail Address Tab Page

Because the C□1W-EIP21S does not support the mail functions, you cannot move the settings from the C□1W-ETN21's **Mail Address** Tab Page.

<C□1W-ETN21>

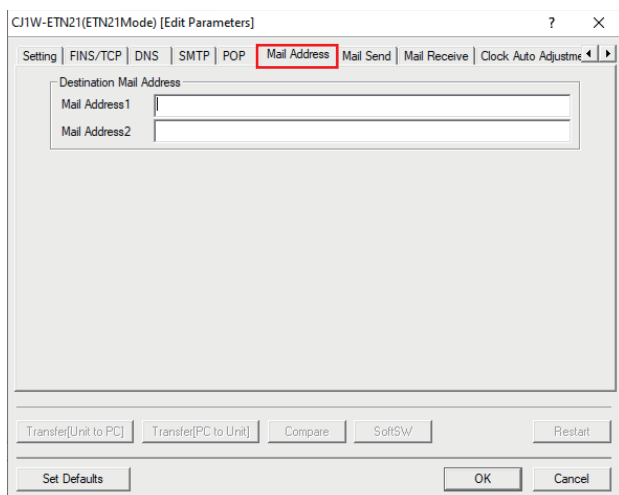

<C□1W-EIP21S>

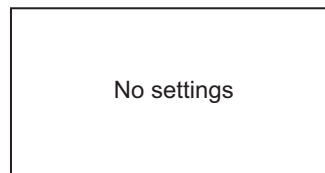

Moving the Settings from the Mail Send Tab Page

Because the C□1W-EIP21S does not support the mail functions, you cannot move the settings from the C□1W-ETN21's **Mail Send** Tab Page.

<C□1W-ETN21>

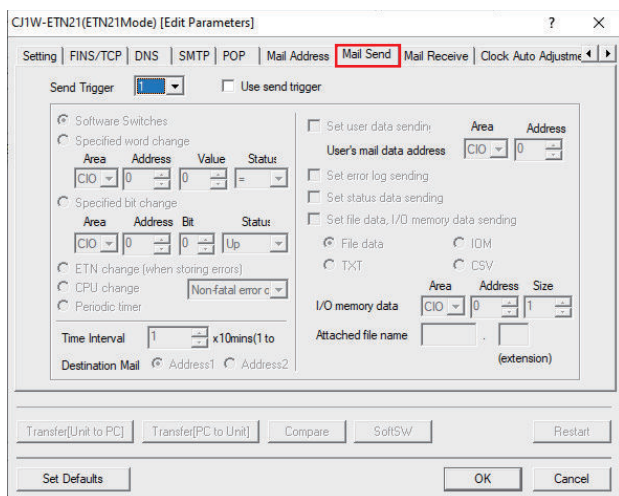

<C□1W-EIP21S>

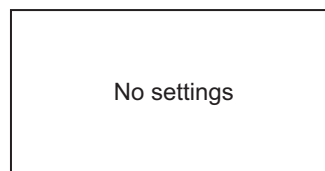

Moving the Settings from the Mail Receive Tab Page

Because the C□1W-EIP21S does not support the mail function, you cannot move the settings from the C□1W-ETN21's **Mail Receive** Tab Page.

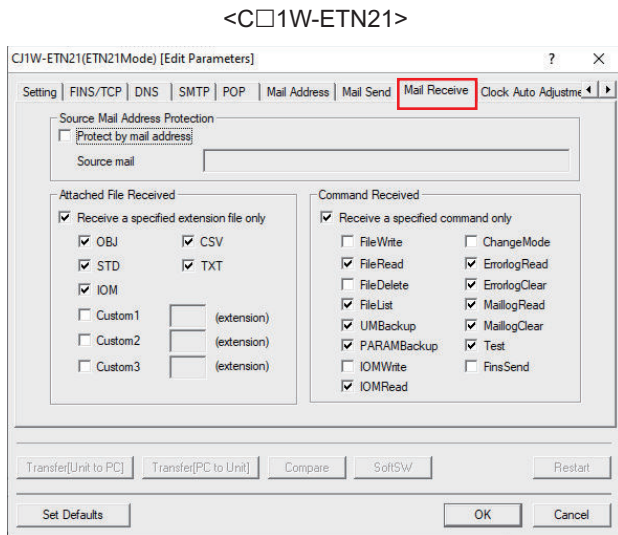

<C□1W-EIP21S>

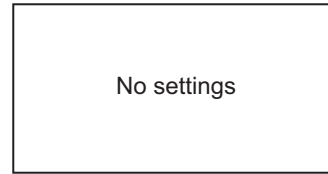

Moving the Settings from the Clock Auto Adjustment Tab Page

Move the settings from the **Clock Auto Adjustment** Tab Page for the C□1W-ETN21 to the corresponding locations in the specified tab page for the C□1W-EIP21S as shown below.

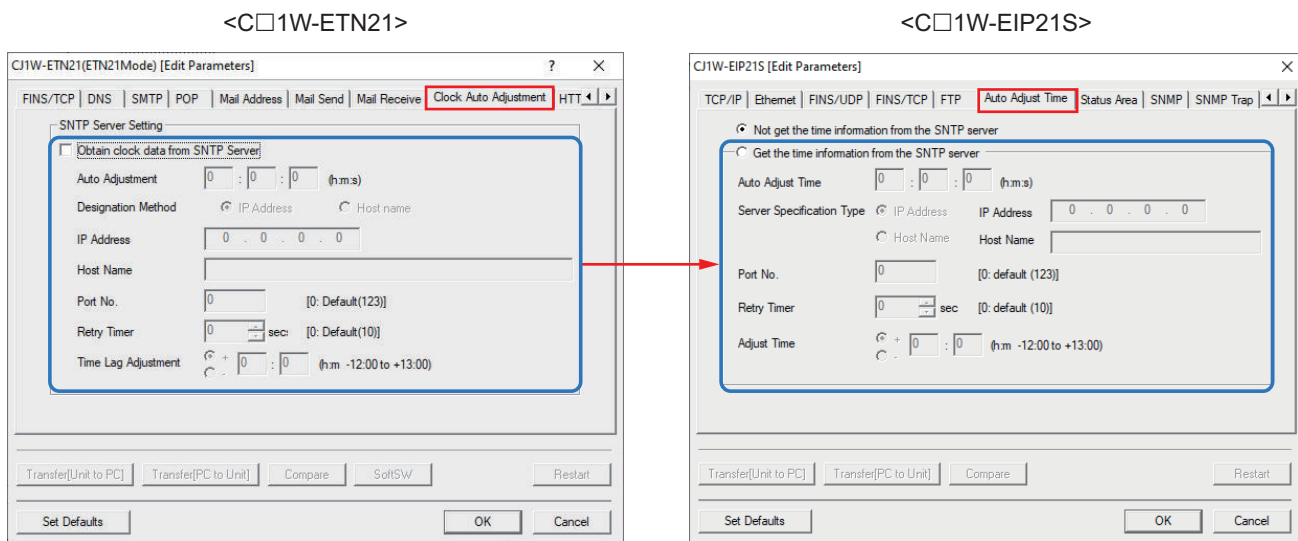

To use automatic clock adjustment, select the **Get the time information from the SNTP server** Check Box.

Moving the Settings from the HTTP Tab Page

Because the C□1W-EIP21S does not support the web functions, you cannot move the settings from the C□1W-ETN21's **HTTP** Tab Page.

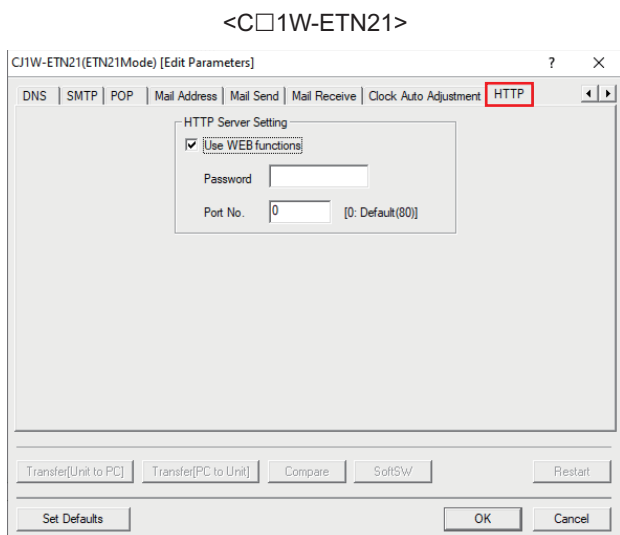

<C□1W-EIP21S>

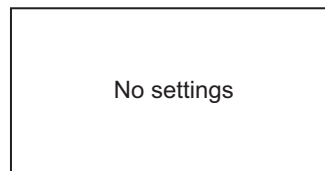

Setting for Using Socket Services (Status Area Tab Page)

To use socket services with the C□1W-EIP21S, you need to configure the following settings in the **Status Area** Tab Page.

- In **Layout Type**, change the setting to **User defined**.
- In **Allocation Area**, register the first word of a consecutive 64 words of unused area.

<C□1W-ETN21>

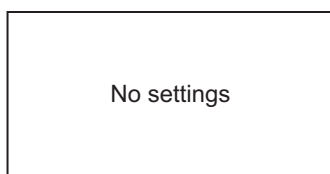

<C□1W-EIP21S>

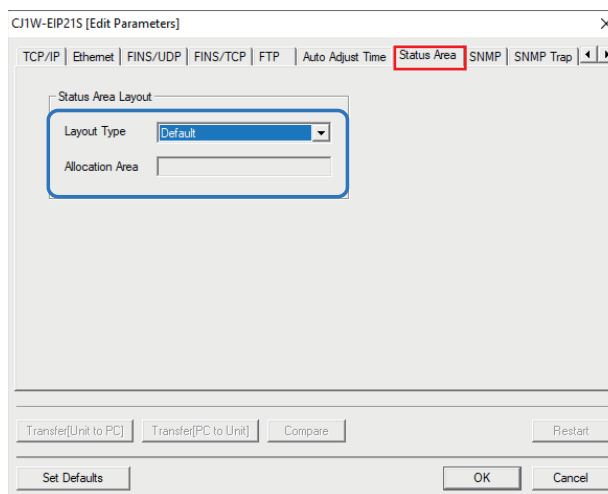

4-3-8 Editing PLC Settings

Configure the following settings as required to deal with the restrictions on replacement.

- **Power Off Detection Time**

- **Power OFF Detection Time**

Set this according to *Setting the Power OFF Detection Time* on page 2-37 in 2-3-8 *Setting Up the CPU Unit* on page 2-36.

4-3-9 Editing the User Program

When you replace the Ethernet Unit with the C□1W-EIP21S, there is no need to change the instructions, etc. However, you need to change the word addresses and bit configuration in the allocated CIO Area and DM Area words for the Unit as they are changed significantly.

You need to edit the user program if these areas are used by the user program.

In addition, the fragment size of TCP transmission data changes with socket services as below.

- C□1W-ETN21: 1,024 bytes
- C□1W-EIP21S: 1,460 bytes

Check the impact on the user program at the receive side, and edit the user program if necessary.

Differences in Allocated CIO Area Words

The following shows the differences in the allocated CIO Area words.

Change the words and bits used by the user program according to the table below.

Word*1	CJ1W-ETN21 CS1W-ETN21					CJ1W-EIP21S CS1W-EIP21S				Change description
	15	8	7	0		15	8	7	0	
n	Unit Control Bits					Unit Control Bits				The bit configuration is different.*2
n+1	UDP Socket No. 1 Status					Socket Service Request Switch 2		Socket Service Request Switch 1		The address is different. The bit configuration is the same. If a socket service is used, a configuration change is required.
n+2	UDP Socket No. 2 Status					Socket Service Request Switch 4		Socket Service Request Switch 3		
n+3	UDP Socket No. 3 Status					Socket Service Request Switch 6		Socket Service Request Switch 5		
n+4	UDP Socket No. 4 Status					Socket Service Request Switch 8		Socket Service Request Switch 7		
n+5	UDP Socket No. 5 Status					Reserved				---
n+6	UDP Socket No. 6 Status					Reserved				---
n+7	UDP Socket No. 7 Status					Reserved				---
n+8	UDP Socket No. 8 Status					Reserved				---
n+9	TCP Socket No. 1 Status				Reserved				---	
n+10	TCP Socket No. 2 Status				Unit Status 1				---	
n+11	TCP Socket No. 3 Status				Unit Status 2				---	
n+12	TCP Socket No. 4 Status				Communications Status 1				---	
n+13	TCP Socket No. 5 Status				Communications Status 2				The Service Status is reflected.	
n+14	TCP Socket No. 6 Status				Communications Status 3				The Error Status is reflected.	
n+15	TCP Socket No. 7 Status				Reserved				---	
n+16	TCP Socket No. 8 Status				UDP Socket No. 2 Status		UDP Socket No. 1 Status		The address and the bit configuration are different.*3 If a socket service is used, a configuration change is required.	
n+17	Service Status				UDP Socket No. 4 Status		UDP Socket No. 3 Status			
n+18	Error Status				UDP Socket No. 6 Status		UDP Socket No. 5 Status			
n+19	Socket Service Request Switch 2		Socket Service Request Switch 1		UDP Socket No. 8 Status		UDP Socket No. 7 Status			
n+20	Socket Service Request Switch 4		Socket Service Request Switch 3		TCP Socket No. 2 Status		TCP Socket No. 1 Status			
n+21	Socket Service Request Switch 6		Socket Service Request Switch 5		TCP Socket No. 4 Status		TCP Socket No. 3 Status			
n+22	Socket Service Request Switch 8		Socket Service Request Switch 7		TCP Socket No. 6 Status		TCP Socket No. 5 Status			
n+23	FINS/TCP Connection Status				TCP Socket No. 8 Status		TCP Socket No. 7 Status		The address is different. The bit configuration is the same.	
n+24	Not used				FINS/TCP Connection Status					

*1. n = 1500 + (25 × Unit number)

*2. The figure below shows the differences in the bit configuration of the Unit Control Bits.

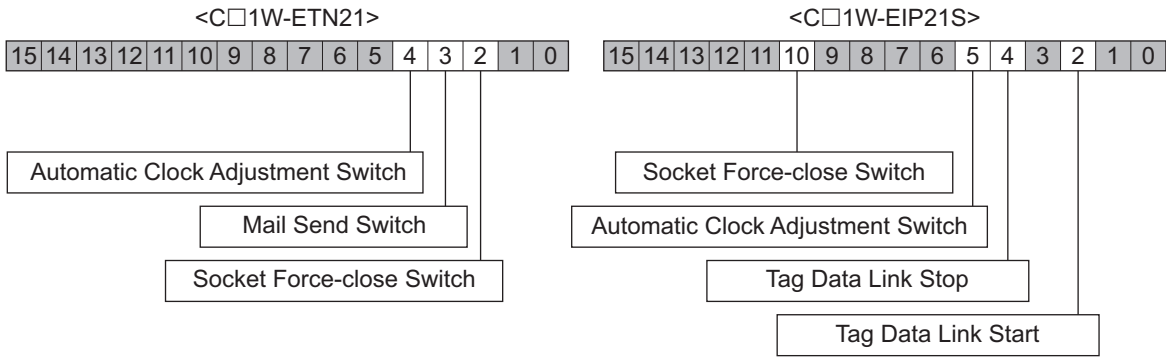

*3. The figure below shows the differences in the bit configuration of the UDP/TCP Socket No. 1 to No. 8 Status.

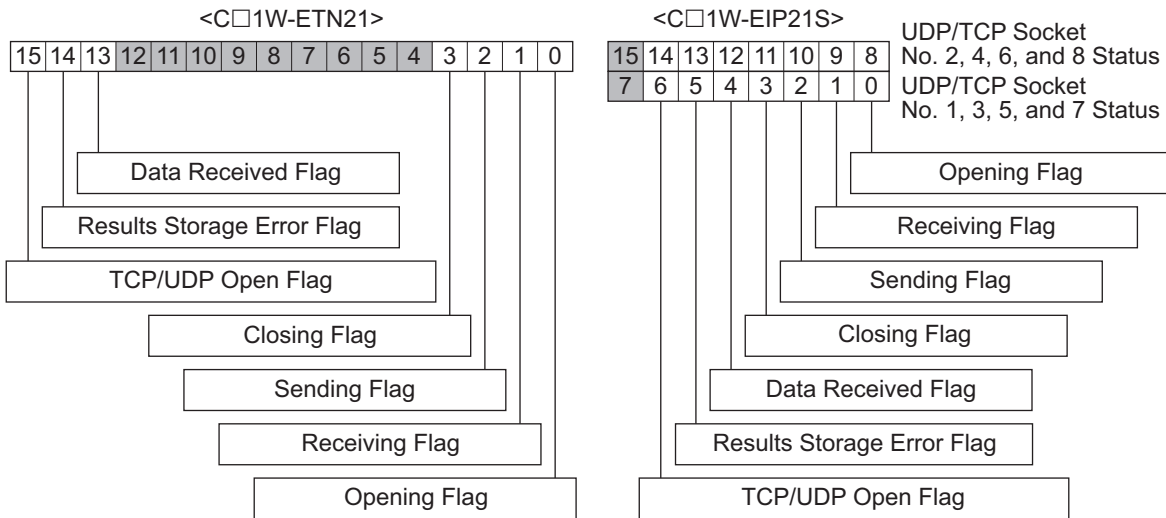

Differences in Allocated DM Area Words

The following shows the differences in the allocated DM Area words.

Change the words and bits used by the user program according to the table below.

Word*1	CJ1W-ETN21 CS1W-ETN21		CJ1W-EIP21S CS1W-EIP21S	Change description
m	Send Mail Status 1		Not used	---
m+1	Number of Bytes Received at TCP Socket No. 1	}	Number of Bytes Received at TCP Socket No. 1	There is no change in the address and the bit configuration.
m+2	Number of Bytes Received at TCP Socket No. 2		Number of Bytes Received at TCP Socket No. 2	
:	:		:	
m+8	Number of Bytes Received at TCP Socket No. 8		Number of Bytes Received at TCP Socket No. 8	
m+9	TCP Socket No. 1 Connection Status	}	TCP Socket No. 1 Connection Status	There is no change in the address and the bit configuration.
m+10	TCP Socket No. 2 Connection Status		TCP Socket No. 2 Connection Status	
:	:		:	
m+16	TCP Socket No. 8 Connection Status		TCP Socket No. 8 Connection Status	
m+17	Send Mail Status 2		Socket Service Parameter Area 1	The address is offset by one word. If a socket service is used, a configuration change is required.
m+18	Socket Service Parameter Area 1			
:				
m+26			Socket Service Parameter Area 2	
m+27				
m+28	Socket Service Parameter Area 2			
:				
m+36			Socket Service Parameter Area 3	
m+37				
m+38	Socket Service Parameter Area 3			
:				
m+46			Socket Service Parameter Area 4	
m+47				
m+48	Socket Service Parameter Area 4			
:				
m+56			Socket Service Parameter Area 5	
m+57				
m+58	Socket Service Parameter Area 5			
:				
m+66			Socket Service Parameter Area 6	
m+67				
m+68	Socket Service Parameter Area 6			
:				
m+76			Socket Service Parameter Area 7	
m+77				
m+78	Socket Service Parameter Area 7			
:				
m+86			Socket Service Parameter Area 8	
m+87				
m+88	Socket Service Parameter Area 8			
:				
m+96				
m+97			D5 Error (Verification Error, Target Nonexistent) Mask Setting Area	---
m+98	IP Address Display/Setting Area		IP Address Display/Setting Area	There is no change in the address and the bit configuration.
m+99				

*1. $m = D30000 + (100 \times \text{Unit number})$

Editing the User Program

Correct the allocated CIO Area and DM Area words.

- 1** Check if the allocated CIO Area or DM Area words are used by the user program. Use the CX-Programmer's cross-reference function to check if the words and bits are used in the user program. **View – Cross-Reference Report**

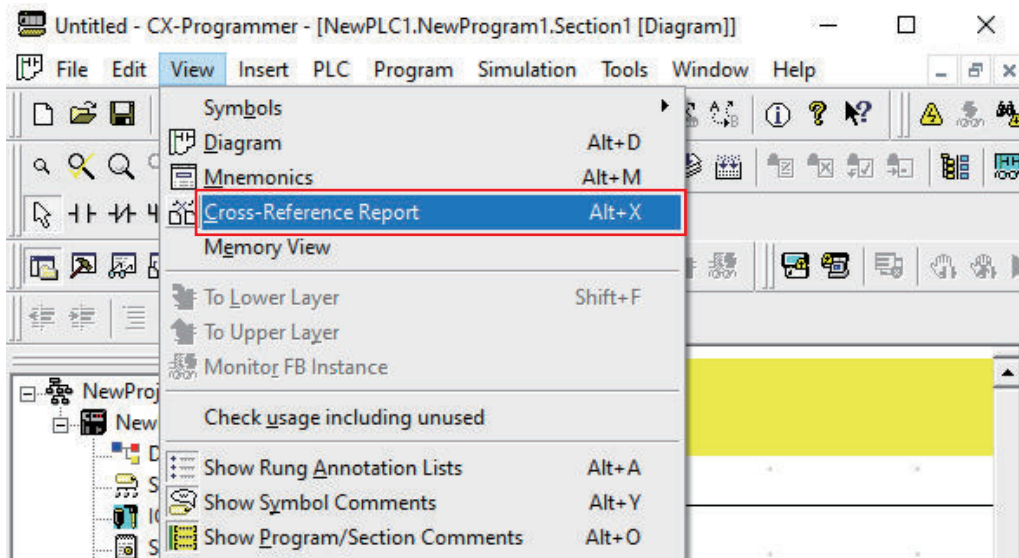

The following view is displayed. Set the following items and click the **Generate** Button.

- 1) **Report type: Detailed usage**

- 2) **Memory area: IO**

In this view, check whether or not the allocated CIO Area words are used.

For example, for unit number 0, the allocated CIO Area words are CIO 1500 to CIO 1524.

Note that, in the figure below, 1500.02 and 1500.04 are used.

Address	Program/Section	Step	Instruction	Start Address	Symbol	Comments
0	NewProgram1/Section1	0	LD [1]	0.00		
0.00	NewProgram1/Section1	0	LD [1]	0.00		
1500	NewProgram1/Section1	1	@SET [1]	1500.02		
1500	NewProgram1/Section1	2	@SET [1]	1500.04		
1500.02	NewProgram1/Section1	1	@SET [1]	1500.02		
1500.04	NewProgram1/Section1	2	@SET [1]	1500.04		

Similarly, you can set the **Memory area: D** to search the allocated DM Area words.

- 2** Correct the user program.

Double-click an address or bit in the Detailed usage report to jump to the location where it is used in the program. Then, correct addresses and bits according to the differences in the area.

In this example, change 1500.02 to 1500.10 and 1500.04 to 1500.05.

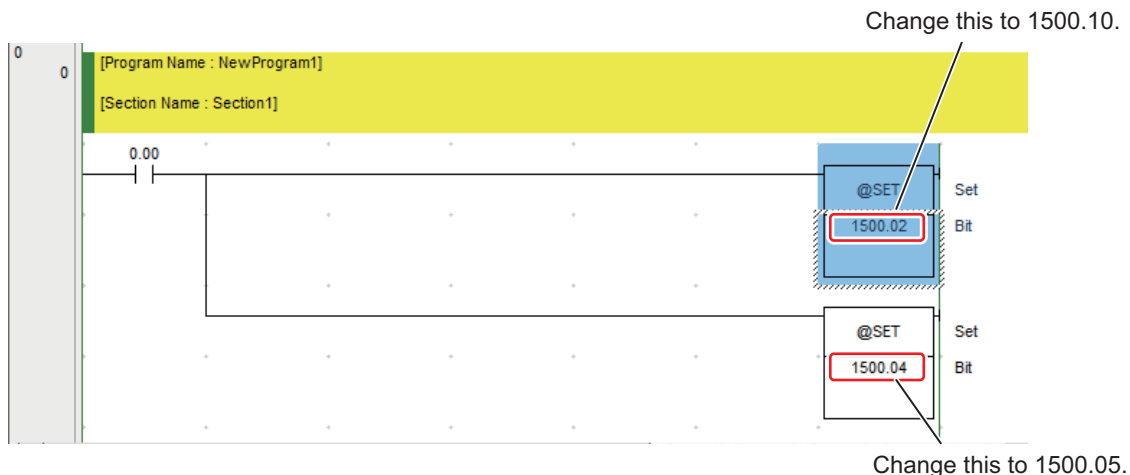

For correction, **Replace** and **Change All** are provided in the **Edit** Menu. The figure below shows the corresponding dialog boxes.

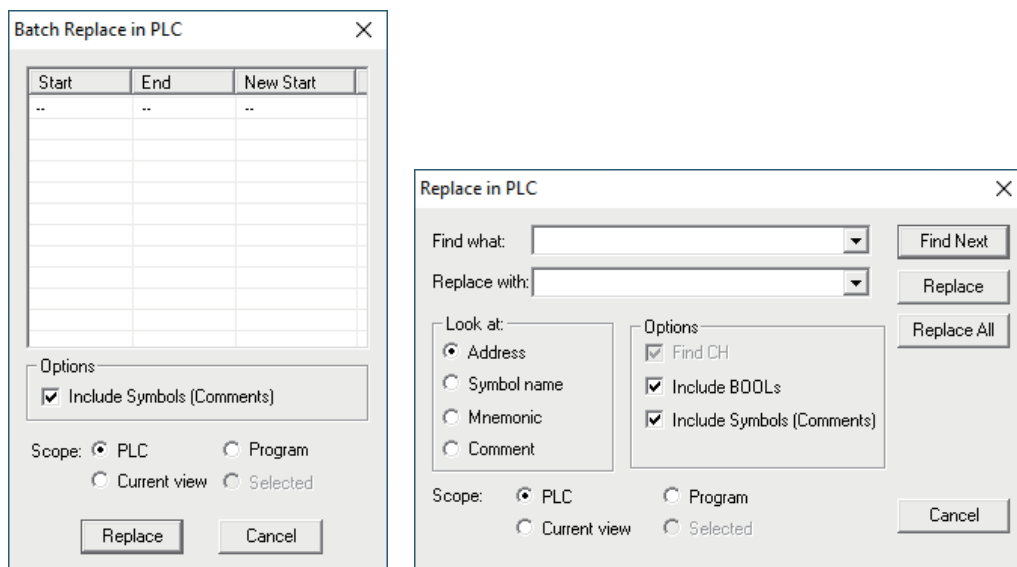

Editing the User Program in Other Cases

There are cases where using only Replace and Change All is not sufficient for correcting the program. In addition, the fragment size of TCP transmission data changes with socket services. The following shows the cases where using the above are not sufficient, and the changes of fragment size.

● Where Bit-specified Instructions Are Used

If bit-specified instructions are used, you need to change the values of the specified operands. The following is a programming example for copying the Data Received Flag (bit 13) of the UDP Socket No. 1 Status in CIO 1501 to bit 0 of CIO 300.

To edit this instruction for the C□1W-EIP21S, change the address to CIO 1516. In addition, you need to change the second operand from *D(13)* to *04* due to the change in the bit configuration from bit 13 to bit 4.

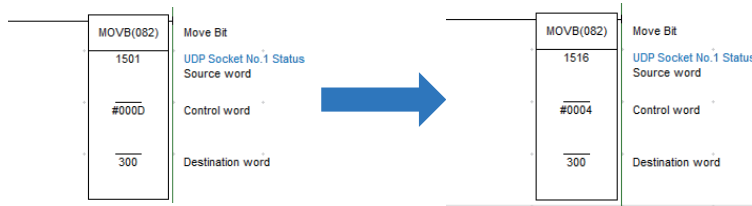

● **Where Indirect DM Addresses or Index Registers Are Used**

You cannot check indirect DM addresses and index registers in Detailed usage report. Use the **Ctrl + F** Keys to display the search dialog box and check for the presence of *IR*, **D*, **E*, *@D*, *@E*, etc. If any of them is present, check if the allocated CIO Area or DM Area words are specified.

● **Where Function Blocks for Socket Services Are Used**

The source replacement model provides function blocks for socket services. However, they are designed for the C□1W-ETN21 and cannot be used for the C□1W-EIP21S. To use these function blocks, replace them with those for the C□1W-EIP21S.

The table below shows socket service function blocks for the C□1W-ETN21 and C□1W-EIP21S.

Function name	Source replacement model C□1W-ETN21		Target replacement model C□1W-EIP21S	
	FB number	FB name	FB number	FB name
Open TCP Socket Passive	ETN001	_ETN001_SOCKET_TcpOpen-Passive	EIPS001	_EIPS001_SOCKET_TcpOpen-Passive
Open TCP Socket Active	ETN002	_ETN002_SOCKET_TcpOpenActive	EIPS002	_EIPS002_SOCKET_TcpOpenActive
Close TCP Socket	ETN003	_ETN003_SOCKET_TcpClose	EIPS003	_EIPS003_SOCKET_TcpClose
Send via TCP Socket	ETN004	_ETN004_SOCKET_TcpSend	EIPS004	_EIPS004_SOCKET_TcpSend
Receive via TCP Socket	ETN005	_ETN005_SOCKET_TcpRecv	EIPS005	_EIPS005_SOCKET_TcpRecv
Open UDP Socket	ETN011	_ETN011_SOCKET_UdpOpen	EIPS011	_EIPS011_SOCKET_UdpOpen
Close UDP Socket	ETN013	_ETN013_SOCKET_UdpClose	EIPS013	_EIPS013_SOCKET_UdpClose
Receive via UDP Socket	ETN014	_ETN014_SOCKET_UdpRecv	EIPS014	_EIPS014_SOCKET_UdpRecv
Send via UDP Socket	ETN015	_ETN015_SOCKET_UdpSend	EIPS015	_EIPS015_SOCKET_UdpSend

Refer to the Smart FB Library Reference available in the CX-Programmer Help for details on how to use these function blocks.

● **Fragment Size Changes of TCP Transmission Data**

The fragment size of TCP transmission data changes with socket services as below.

- C□1W-ETN21: 1,024 bytes
- C□1W-EIP21S: 1,460 bytes

Check the impact on the user program at the receive side, and edit the user program if necessary.

4-3-10 Editing Allocated CIO Area or DM Area Words

- **When Data Is Directly Written**

There are cases where data is written directly to allocated CIO Area or DM Area words for use in setting data. In such cases, check that data is not written to the allocated CIO Area or DM Area words in the source replacement model. If data is written, move the data to the allocated CIO Area or DM Area words in the target replacement model.

- **When Data Is Written/Read to/from the Allocation Area by Other Devices**

There are cases where data is written to allocated DM Area words by another device (HMI or computer) connected to the network. In such cases, change the location that the device writes to or reads from according to the changes in the allocated CIO Area or DM Area words due to replacement.

4-3-11 Saving the Project File

After completion of the edits, rename and save the project file.

File – Save As

4-4 Replacement

This section describes the actual replacement steps.

4-4-1 Replacing and Wiring Units

- 1** Back up the data before you perform replacement.
Taking into account the risk that you fail in replacement, perform simple backup with a Memory Card, or back up the PLC data with the PLC Backup Tool.
- 2** Turn OFF the power supply to the equipment.
- 3** Disconnect the cable from the C□1W-ETN21 and remove the Unit.
- 4** Configure the hardware settings of the C□1W-EIP21S, i.e., the unit number and node address, to match those of the source replacement model C□1W-ETN21.
- 5** Mount the C□1W-EIP21S. Do not install the cable at this point. You will install it in the later operation check process.

4-4-2 Turning ON the Power Supply

Check the safety of the equipment and turn ON the power supply to the PLC after replacement.



Precautions for Correct Use

The C□1W-EIP21S requires a Unit startup time. For this reason, the CPU Unit startup time will be delayed by a few seconds compared with the system before replacement.

4-4-3 Transferring the I/O Table

If any of the following errors occur after the power supply to the PLC is turned ON, transfer the I/O table for the Unit configuration after replacement, which you created in *4-3-5 Creating an I/O Table* on page 4-10, to the PLC.

- CPU Bus Unit setting error
- I/O setting error (CJ Series)
- I/O verification error (CS Series)

To do so, connect the CX-Programmer directly to the USB port, peripheral port, etc. on the CPU Unit and transfer it online. At this point, you do not need to transfer the Special Unit settings. You will transfer them later in *4-4-4 Transferring Data (to PLC)* on page 4-30.

On completion of the transfer, the above errors are removed because the I/O table that matches the actual configuration after replacement is registered in the CPU Unit.



Precautions for Correct Use

The CS Series operates only when the I/O table is registered in the CPU Unit.

Transferring the I/O Table

Follow the steps below to transfer the I/O table.

Refer to the *CX-Programmer Ver. 9.□ Operation Manual (Cat. No. W446)* in addition to this manual for how to operate the CX-Programmer and connect the CPU Unit to the CX-Programmer. Refer also to the user's manual for your CPU Unit for how to connect the CPU Unit to the CX-Programmer.

- 1** Connect the CPU Unit and the computer with a Support Software connection cable, etc.
- 2** Start the CX-Programmer.
- 3** Connect the CX-Programmer online to the PLC and change to PROGRAM mode.
PLC – Work Online
PLC – Operating Mode – Program
- 4** Transfer the I/O table to the PLC.
PLC – Transfer – To PLC

(1) Select the IO table Check Box.

(2) Click the **OK** Button.

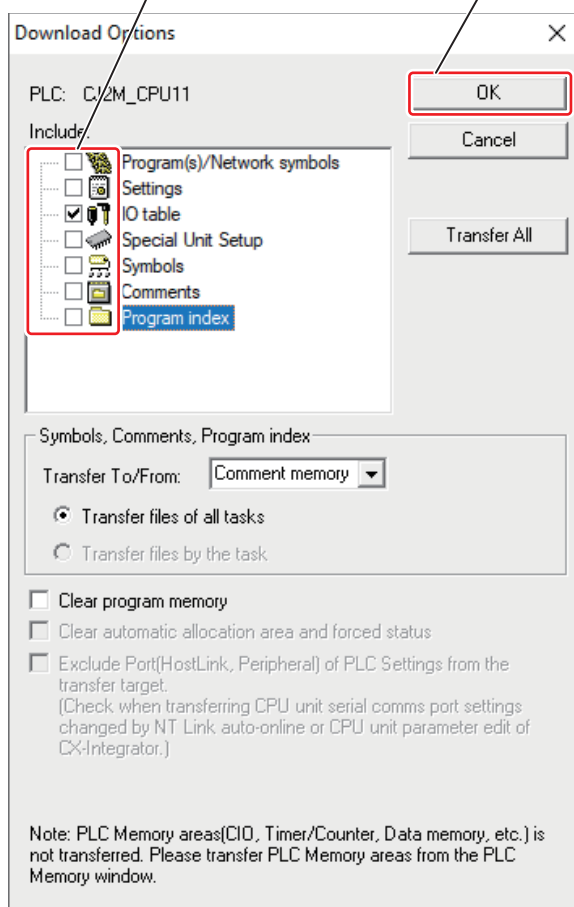

4-4-4 Transferring Data (to PLC)

Transfer the PLC project data that you created to match the Unit configuration after replacement during preparation to the actual PLC. To do so, connect the CX-Programmer directly to the USB port, peripheral port, etc. on the CPU Unit and place it online.

The following is the PLC project data to transfer. Note that there is no need to transfer data that was not edited during preparation.

- User program
- PLC settings
- I/O table
- Special Unit settings
- DM Area information

Transfer PLC project data according to *Transferring PLC Project Data* on page 2-50 in 2-4-3 *Transferring Data* on page 2-49.

4-4-5 Checking the Operation

- 1** Turn OFF the power supply to the PLC.
- 2** Install the cable to the C□1W-EIP21S.
- 3** Check the safety of the equipment and turn ON the power supply to the PLC.
- 4** Confirm that the equipment operates as intended.

Refer to the user's manual for your Unit for the operation check and troubleshooting procedures for each Unit.

4-4-6 Implementing Security Measures

If necessary, implement measures to reduce the security risks from external attacks before the start of system operation after replacement. We recommend that you set user authentication and use secure communications (Secure Comm) to connect the Support Software online to the C□1W-EIP21S EtherNet/IP port.

In addition to user authentication and secure communications (Secure Comm), the C□1W-EIP21S and Support Software provide other security functions to reduce security risks. Use these security functions in conjunction with system operation to further reduce the security risks.

For details, refer to 2-4-5 *Implementing Security Measures* on page 2-55.

4-4-7 Checking the Operation after Implementing Security Measures

After you implement security measures, check to be sure that the system operates according to the security settings.

5

Replacing a System with the CS1D-ETN21D

This section describes the replacement flow and replacement procedures for a system with the CS1D-ETN21D.

5-1	Differences and Changes in Specifications and Functions	5-2
5-1-1	Differences in Specifications and Functions	5-2
5-1-2	Changes during Replacement	5-5
5-2	Replacement Flow	5-6
5-2-1	Flow of Preparation	5-6
5-2-2	Flow of Replacement	5-7
5-3	Preparation	5-9
5-3-1	Checking the Target Replacement Model	5-9
5-3-2	Checking the Differences in Specifications, Functions, Etc.	5-9
5-3-3	Getting the Support Software	5-9
5-3-4	Reading and Saving Data	5-9
5-3-5	Creating an I/O Table	5-12
5-3-6	Selecting the Power Supply Unit and Checking the Dimensions	5-13
5-3-7	Editing the Routing Table	5-13
5-3-8	Configuring Special Unit Settings	5-14
5-3-9	Editing PLC Settings	5-17
5-3-10	Editing the User Program	5-18
5-3-11	Editing Allocated CIO Area or DM Area Words	5-22
5-3-12	Saving the Project File	5-23
5-4	Replacement	5-24
5-4-1	Replacing and Wiring Units	5-24
5-4-2	Turning ON the Power Supply	5-24
5-4-3	Resetting Errors	5-24
5-4-4	Transferring Data (to PLC)	5-26
5-4-5	Checking the Operation	5-29
5-4-6	Implementing Security Measures	5-29
5-4-7	Checking the Operation after Implementing Security Measures	5-30

5-1 Differences and Changes in Specifications and Functions

This section describes the differences in specifications and functions between the source replacement model (CS1D-ETN21D) and the target replacement model (CS1W-EIP21S), and the changes to be made during replacement.



Precautions for Correct Use

The CS1W-EIP21S does not support the duplex network function supported by the CS1D-ETN21D. To replace the CS1D-ETN21D that uses duplex network with the CS1W-EIP21S, you need to create a duplex network program.

Create the program so that the duplex system specifications before replacement are satisfied. After replacement, perform a thorough duplex system evaluation to check that the duplex system specifications are satisfied.

Refer to *Creating a Duplex Communications Program* on page 5-19 for creating a duplex network program. Refer to *A-1 Duplex Communications Sample Programming* on page A-2 for sample programming.

5-1-1 Differences in Specifications and Functions

The table below shows the differences in specifications and functions between the source replacement model (CS1D-ETN21D) and the target replacement model (CS1W-EIP21S).

Yes: Supported, No: Not supported

Item	Source replacement model	Target replacement model	Effects of replacement
	CS1D-ETN21D	CS1W-EIP21S	
Duplex Ethernet network (Duplex FINS communications)	Yes	No	The duplex network program needs to be created. Other impacts include the following. <ul style="list-style-type: none"> The network switching time in the event of an error will change. If there is a duplex computer on the system, the program on the computer side also needs to be edited to a duplex program. The communications beyond the network using FINS message communications cannot be performed. The Network Participation Status is not available.
Setting with a Memory Card text file	Yes	No	This functions is not available.
Tag data link communications service	No	Yes	There is no effect.
CIP message communications service	No	Yes	There is no effect.

Item	Source replacement model	Target replacement model	Effects of replacement
	CS1D-ETN21D	CS1W-EIP21S	
FINS/UDP service	Yes	Yes	To use this service, set Use FINS/UDP service .
FINS/TCP service	Yes	Yes	To use this service, set Use FINS/TCP service .
Keep-alive	Yes	Yes	The default keep-alive value is different. Change the default value, if used, to 120 min.
Socket service	No	Yes	There is no effect.
File transfer (FTP)	No	Yes	There is no effect.
Automatic adjustment of PLC's internal clock	No	Yes	There is no effect.
Security	No	Yes	We recommend using these functions to reduce security risks, if necessary. To use these functions, configure the settings.
Simple backup function	Yes	Yes	You cannot restore backup data from the CS1D-ETN21D to the CS1W-EIP21S.
Error log	Yes	Yes	There is no effect.
Response to PING command	Yes	Yes	There is no effect.
SNMP/SNMP trap	No	Yes	There is no effect.
CIDR function for IP addresses	No	Yes	There is no effect.
Online connection by EtherNet/IP using CX-One	No	Yes	After replacement, we do not recommend using this connection method to reduce security risks.
Online connection by Ethernet (FINS) using CX-One	Yes	Yes	After replacement, we do not recommend using this connection method to reduce security risks. To connect online with Ethernet network type setting, you should set the Unit to use FINS/UDP service. To connect online with Ethernet (FINS/TCP) network type setting, you should set the Unit to use FINS/TCP service.
Online connection from CX-One to CPU Unit via EtherNet/IP port with secure communications	No	Yes	After replacement, we recommend using these functions to reduce security risks. To use this function, configure the settings.
Online connection by EtherNet/IP using Network Configurator	No	Yes	There is no effect.
Monitoring Unit Control Bits with CX-Programmer	Yes	No	You cannot monitor Unit Control Bits with the CX-Programmer.
Layout of allocated CIO Area and DM Area words	---	---	The user program needs to be edited because the address configuration is different.
Current consumption (5 VDC)	380 mA	620 mA	The current consumption increases.

Item	Source replacement model	Target replacement model	Effects of replacement
	CS1D-ETN21D	CS1W-EIP21S	
Use restriction on the Power Supply Unit	---	---	<p>The following restrictions apply to the target replacement model. Check if changing the Power Supply Unit is necessary depending on the amount of increase in current consumption.</p> <ul style="list-style-type: none"> Restrictions on the Power Supply Unit with or without the power OFF detection time
Unit startup time	---	---	<p>The target replacement model has a longer Unit startup time. For this reason, the CPU Unit startup time will be delayed by a few seconds compared with the system before replacement. This means that you need to check the effects on the startup operation of the system.</p>

5-1-2 Changes during Replacement

The table below shows the changes to be made for each item during replacement.

These settings are configured with the CX-Programmer and CX-Integrator.

Except for the routing table, use the CX-Programmer. For the routing table, use the CX-Integrator.

Yes: Change required, No: Change not required

Item	User program	DM Area information	Special Unit settings	PLC settings	I/O table	Routing table	Changes to be made during replacement
Replacing Units Duplex Ethernet network (Duplex FINS communications)	Yes (a)	Yes (b)	Yes (c)	Yes (d)	Yes (e)	Yes (f)	(a) Create a duplex network program. Also, edit the allocated CIO Area words. (b) If the default IP address is used, set an IP address. You can also set an IP address in the Unit Setup. Set it in the DM Area or in the Unit Setup. (c) Reconfigure the settings to match those of the target replacement model. (d) Disable duplex communications. (e) Change the Unit to the target replacement model. (f) Edit the duplex network settings.
FINS/UDP service	No	No	Yes	No	No	No	Set Use FINS/UDP service .
FINS/TCP service	No	No	Yes	No	No	No	Set Use FINS/TCP service .
Keep-alive	No	No	Yes	No	No	No	The default keep-alive value is different. Change the default value, if used, to 120 min.
Online connection by Ethernet (FINS) using CX-One	No	No	Yes	No	No	No	To connect online with Ethernet network type setting, you should set the Unit to use FINS/UDP service. To connect online with Ethernet (FINS/TCP) network type setting, you should set the Unit to use FINS/TCP service.
Current consumption	No	No	No	No	Yes	No	After you change the I/O table, check the current consumption. If necessary, change the Power Supply Unit or change the Unit configuration.
Use restriction on the Power Supply Unit	No	No	No	Yes	No	No	For the CS-series CS1D, disable the power OFF detection time. To do so, set 0 ms.

5-2 Replacement Flow

This section describes the replacement flow for a system with the Ethernet Unit CS1D-ETN21D. It consists of the flow of preparation and the flow of replacement.

5-2-1 Flow of Preparation

The table below shows the contents of preparation that you should make before replacement. Use this flow to plan a replacement and prepare data that matches the Unit configuration after replacement. Make the target replacement Unit available before replacement.

Step	Item	Description	Reference
1	Checking the Target Replacement Model	Check the target replacement model against the system configuration of the source replacement model. Check also the Support Software that supports the target replacement model.	<i>5-3-1 Checking the Target Replacement Model</i> on page 5-9
2	Checking the Differences in Specifications, Functions, Etc.	Check the differences in specifications, functions, etc. between the source and target replacement models to determine the effects of replacement on the hardware, user program, and applications in the source replacement system.	<i>5-3-2 Checking the Differences in Specifications, Functions, Etc.</i> on page 5-9
3	Getting the Support Software	Get the Support Software that you will use for preparation and replacement.	<i>5-3-3 Getting the Support Software</i> on page 5-9
4	Reading and Saving Data	Read and save the following data from the source replacement system. You will use the data read in this step, and edit or set it in subsequent steps to match the target replacement system. <ul style="list-style-type: none"> • PLC project data • Routing table 	<i>5-3-4 Reading and Saving Data</i> on page 5-9
5	Creating an I/O Table	Create an I/O table to match the Unit configuration after replacement.	<i>5-3-5 Creating an I/O Table</i> on page 5-12
6	Selecting the Power Supply Unit and Checking the Dimensions	Check if it is necessary to change the Power Supply Unit in order to deal with the restrictions on the power supply that arise due to the replacement. If necessary, select an adequate Power Supply Unit. If, after the selection, you change the Power Supply Unit or expand the system, check the difference in the dimensions of the Unit configuration before and after replacement.	<i>5-3-6 Selecting the Power Supply Unit and Checking the Dimensions</i> on page 5-13
7	Editing the Routing Table	Set the routing table.	<i>5-3-7 Editing the Routing Table</i> on page 5-13
8	Configuring Special Unit Settings	Configure the Special Unit settings for the target replacement model to match those of the source replacement model.	<i>5-3-8 Configuring Special Unit Settings</i> on page 5-14
9	Editing PLC Settings	Disable duplex communications. In addition, configure the following settings as required to deal with the restrictions on replacement. <ul style="list-style-type: none"> • Power OFF detection time 	<i>5-3-9 Editing PLC Settings</i> on page 5-17

Step	Item	Description	Reference
10	Editing the User Program	Create a duplex communications program. In addition, there are differences in the allocated CIO Area and DM Area words between the source and target replacement models. Change the user program according to the differences.	5-3-10 <i>Editing the User Program</i> on page 5-18
11	Editing Allocated CIO Area or DM Area Words	Edit the allocated CIO Area or DM Area words of the source replacement model that data is written to or read from to match the corresponding area words in the target replacement model. In addition, if the default IP address is used, set an IP address.	5-3-11 <i>Editing Allocated CIO Area or DM Area Words</i> on page 5-22
12	Saving the Project File	Save the data that you edited.	5-3-12 <i>Saving the Project File</i> on page 5-23

5-2-2 Flow of Replacement

The table below shows the actual replacement steps that you should follow on completion of the preparation steps. You can implement security measures as needed after replacement.

Step	Item	Description	Reference
13	Replacing and Wiring Units	Replace Units according to the Unit configuration after replacement. Then, wire the replaced Units.	5-4-1 <i>Replacing and Wiring Units</i> on page 5-24
14	Turning ON the Power Supply	Turn ON the power supply to the PLC.	5-4-2 <i>Turning ON the Power Supply</i> on page 5-24
15	Resetting Errors	Reset duplex communications errors and CPU Bus Unit setting errors.	5-4-3 <i>Resetting Errors</i> on page 5-24
16	Transferring Data	Write data that you edited during preparation to the PLC.	5-4-4 <i>Transferring Data (to PLC)</i> on page 5-26
17	Checking the Operation	Confirm that the system operates as intended.	5-4-5 <i>Checking the Operation</i> on page 5-29
18	Implementing Security Measures* ¹	If necessary, implement measures to reduce the security risks from external attacks before the start of system operation after replacement. We recommend that you set user authentication and use secure communications (Secure Comm) to connect the Support Software online to the C □1W-EIP21S EtherNet/IP port. In addition to user authentication and secure communications (Secure Comm), the C □1W-EIP21S and Support Software provide other security functions to reduce security risks. Use these security functions in conjunction with system operation to further reduce the security risks.	5-4-6 <i>Implementing Security Measures</i> on page 5-29

Step	Item	Description	Reference
19	Checking the Operation after Implementing Security Measures	After you implement security measures, check to be sure that the system operates according to the security settings.	<i>5-4-7 Checking the Operation after Implementing Security Measures</i> on page 5-30

*1. Do this as needed.

5-3 Preparation

This section describes the preparation steps that you should follow before replacement.

5-3-1 Checking the Target Replacement Model

Check the target replacement model against the system configuration of the source replacement model. Check also the Support Software that supports the target replacement model.

For details, refer to *1-2-4 System with the CS1D-ETN21D* on page 1-11.

5-3-2 Checking the Differences in Specifications, Functions, Etc.

Check the differences in specifications, functions, etc. between the source and target replacement models to determine the effects of replacement on the hardware, user program, and applications in the source replacement system. For details, refer to *5-1 Differences and Changes in Specifications and Functions* on page 5-2.

5-3-3 Getting the Support Software

Get the Support Software that you will use for preparation and replacement. Specifically, get the CX-One version shown in *1-3 Support Software* on page 1-13 or higher.

All Support Software applications that you will use in the following sections are packaged in the CX-One.

5-3-4 Reading and Saving Data

Read and save the following data from the source replacement system.

You will use the data read in this step, and edit or set it in subsequent steps to match the target replacement system.

Data	Description	Reference
PLC project data*1	This data includes the user program, PLC settings, I/O table, Special Unit settings, and DM Area information. Use the CX-Programmer to read it.	<i>Reading PLC Project Data (from PLC)</i> on page 5-9
Routing table	Read the routing table settings. Use the CX-Integrator to read them.	<i>Reading the Routing Table (from PLC)</i> on page 5-10

*1. This data is stored in the CX-Programmer project file. In this manual, it is referred to as PLC project data.

Perform this operation so that you can restore the data from the source replacement system. Even when you have the data in the source replacement system, there is a risk of trouble if it is different from the data in the actual PLC. We recommend that you read and save it.

Reading PLC Project Data (from PLC)

Use the CX-Programmer to read and save the following project data from the source replacement PLC.

- User program

- PLC settings
- I/O table
- Special Unit settings
- DM Area information

Refer to *Reading and Saving PLC Project Data* on page 2-20 in *2-3-4 Reading and Saving Data* on page 2-19 for how to read and save the above data from the PLC.

Reading the Routing Table (from PLC)

Use the CX-Integrator to read and save the routing table from the PLC.

● Reading and Saving the Routing Table

Use the CX-Integrator to read and save the routing table from the PLC as described below.

Refer to the *CS/CJ/CP/NSJ-series CX-Integrator Ver. 2.□ Operation Manual (Cat. No. W464)* in addition to this manual for how to operate the CX-Integrator.

1 Connect the CX-Programmer online to the PLC and open the I/O table.

2 Click the CPU Unit and start the CX-Integrator.

Options – Start Special Application – Start with Settings Inherited

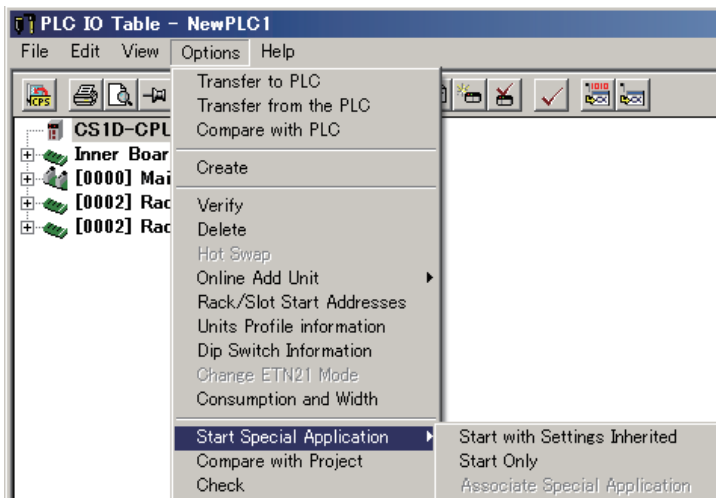

3 In the dialog box displayed, select the port connected to the PLC and click the **OK** Button.

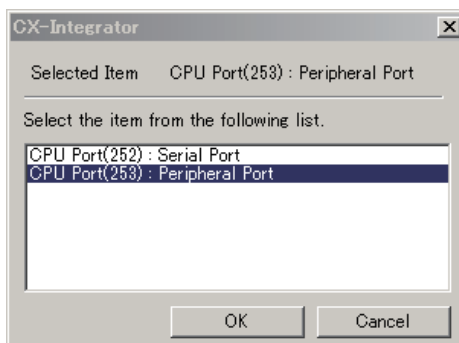

- 4** In the dialog box displayed, select **Network structure only** and click the **Transfer** Button.

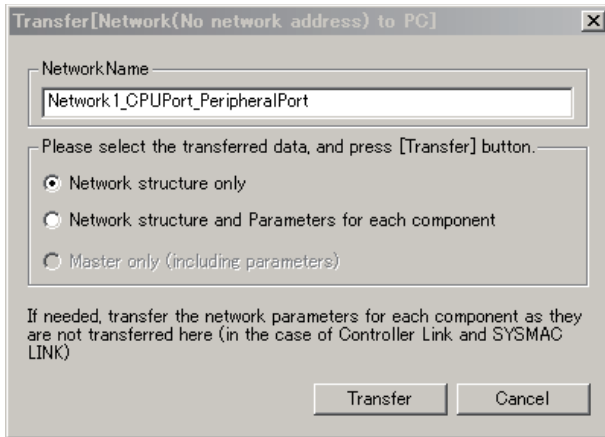

The following image is displayed.

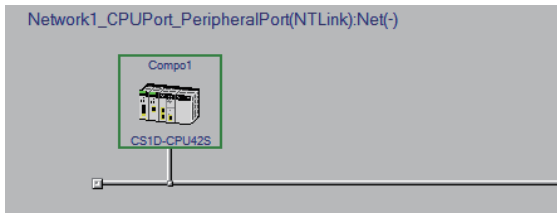

- 5** Start the Routing Table Component and read the routing table from the PLC.

- 1) **Tools – Start Routing table**

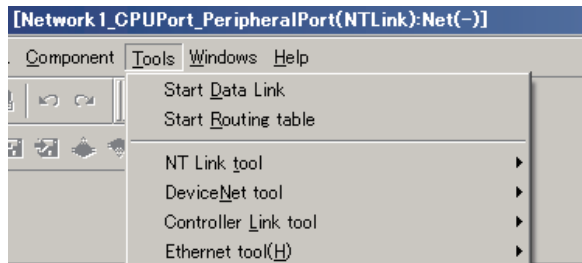

- 2) The following window opens. Click the **Transfer from the PLC** Icon.

(1) Click the **Transfer from the PLC** icon.

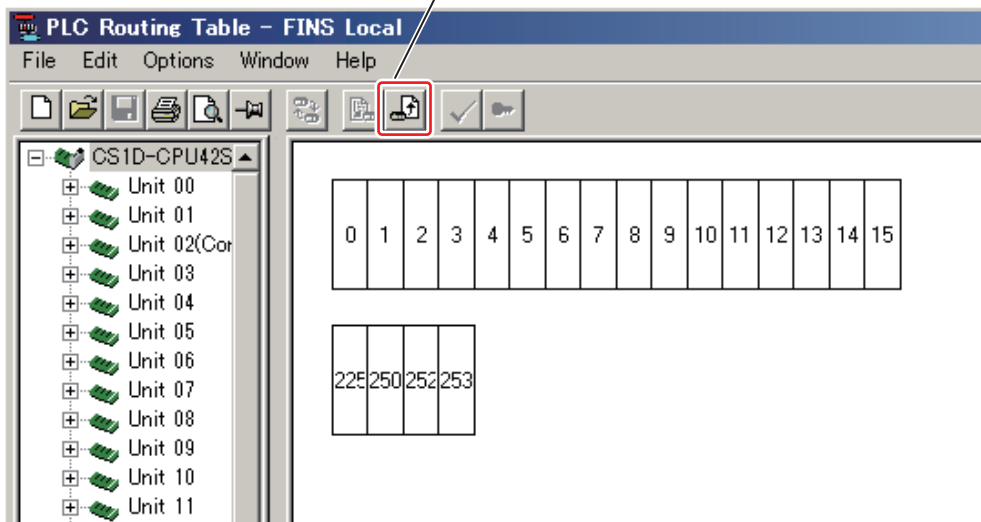

(2) The routing table settings of the device are read and displayed.

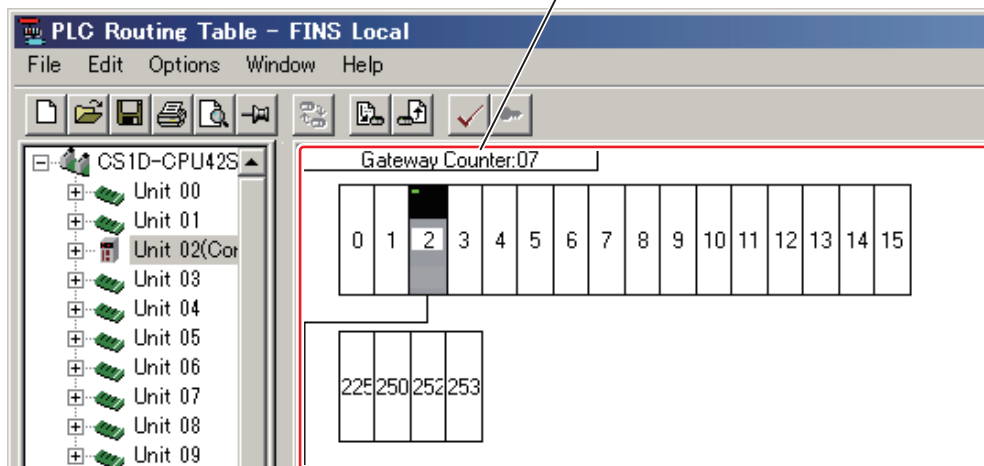

The display remains unchanged if there are no routing table settings.

- 6** Save the routing table to the computer.
File – Save Local Routing Table File

5-3-5 Creating an I/O Table

Create an I/O table to match the Unit configuration after replacement.

Use the CX-Programmer and open the I/O table for the PLC project data for the source replacement model. Then, in the I/O table, change the source replacement Unit to the target replacement Unit.

The following shows how to create an I/O table with the CX-Programmer. Refer to the *CX-Programmer Ver. 9.0 Operation Manual (Cat. No. W446)* in addition to this manual for how to operate the CX-Programmer.

- 1** Use the CX-Programmer and open the I/O table for the PLC project data from the source replacement model.

- 2** In the IO Table Dialog Box, right-click the source replacement model CS1D-ETN21D and select **Change / Confirm Units** from the menu to change it to the target replacement model CS1W-EIP21S. Or, right-click the CS1D-ETN21D and select **Add Unit** to change the Unit to the CS1W-EIP21S.

For each Unit, set the same unit number as that of the source replacement model. In the following example, the Unit numbers are 0 and 1.

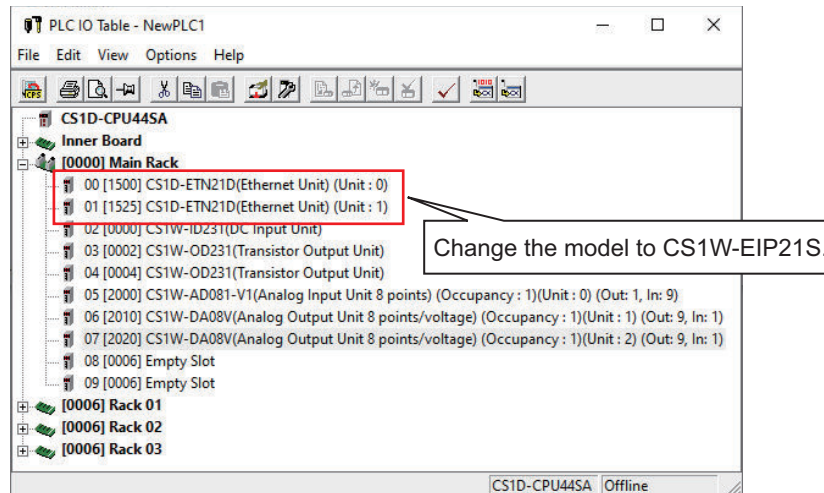

- 3** Repeat step 2 to create an I/O table for the Unit configuration after replacement.



Precautions for Correct Use

The CS Series operates only when the I/O table is registered in the CPU Unit. Be sure to create an I/O table and transfer it to the CPU Unit.

5-3-6 Selecting the Power Supply Unit and Checking the Dimensions

Check if it is necessary to change the Power Supply Unit in order to deal with the restrictions on the power supply that arise due to the replacement. If necessary, select an adequate Power Supply Unit. If, after the selection, you change the Power Supply Unit or expand the system, check the difference in the dimensions of the Unit configuration before and after replacement.

Select the Power Supply Unit and check the dimensions according to *2-3-7 Selecting the Power Supply Unit and Checking the Dimensions* on page 2-32.

5-3-7 Editing the Routing Table

Configure one of the networks enabled with duplex communications.

To do so, open the routing table file that you read and saved from the source replacement PLC in *5-3-4 Reading and Saving Data* on page 5-9.

As shown in the figure below, if local network numbers are set for both of the Communications Units enabled with duplex communications, no changes are needed.

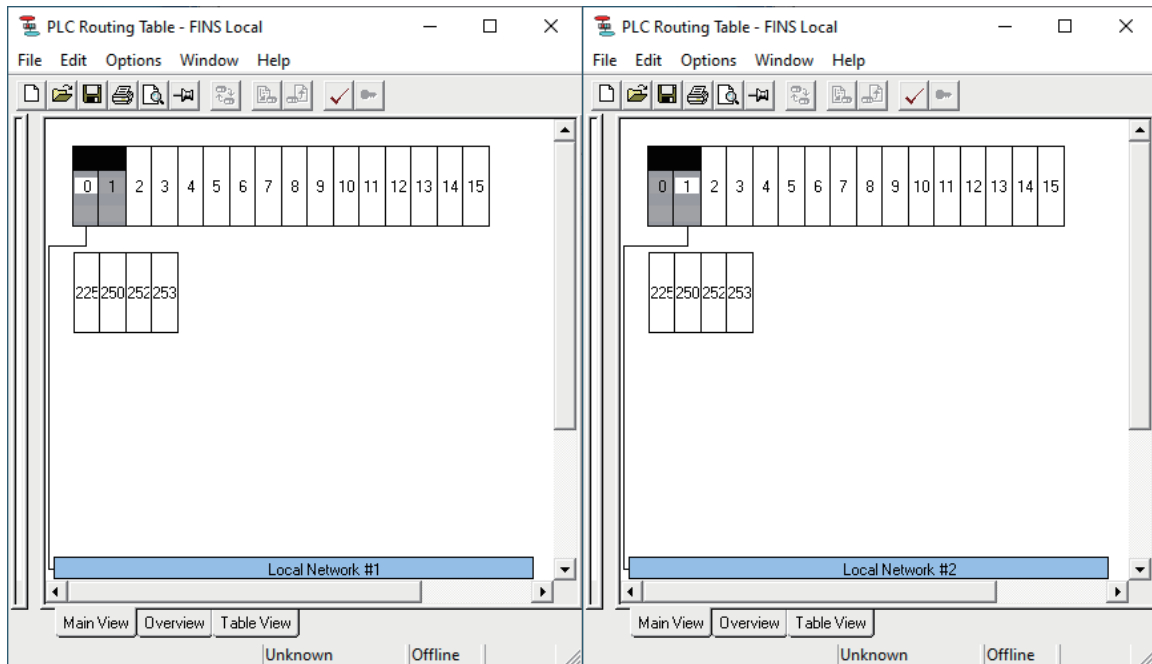

However, if one or both of the Communication Units do not have local network numbers, set their local network numbers.

In such cases, check the settings of the Communications Unit to connect to and configure them accordingly.

5-3-8 Configuring Special Unit Settings

In the CX-Programmer, configure the Special Unit settings for the target replacement model CS1W-EIP21S to match those of the source replacement model CS1D-ETN21D.

However, you cannot perform this operation automatically. Manually move the Special Unit settings that you read from the CS1D-ETN21D in *5-3-4 Reading and Saving Data* on page 5-9 to the CS1W-EIP21S.

The following topics describe how to move these settings.

Moving the Settings from the Setting Tab Page

Move the settings from the **Setting** Tab Page for the CS1D-ETN21D to the corresponding locations in the specified tab page for the CS1W-EIP21S as shown below.

Do this for the two CS1W-EIP21S Units.

● Setting Tab Page to TCP/IP Tab Page

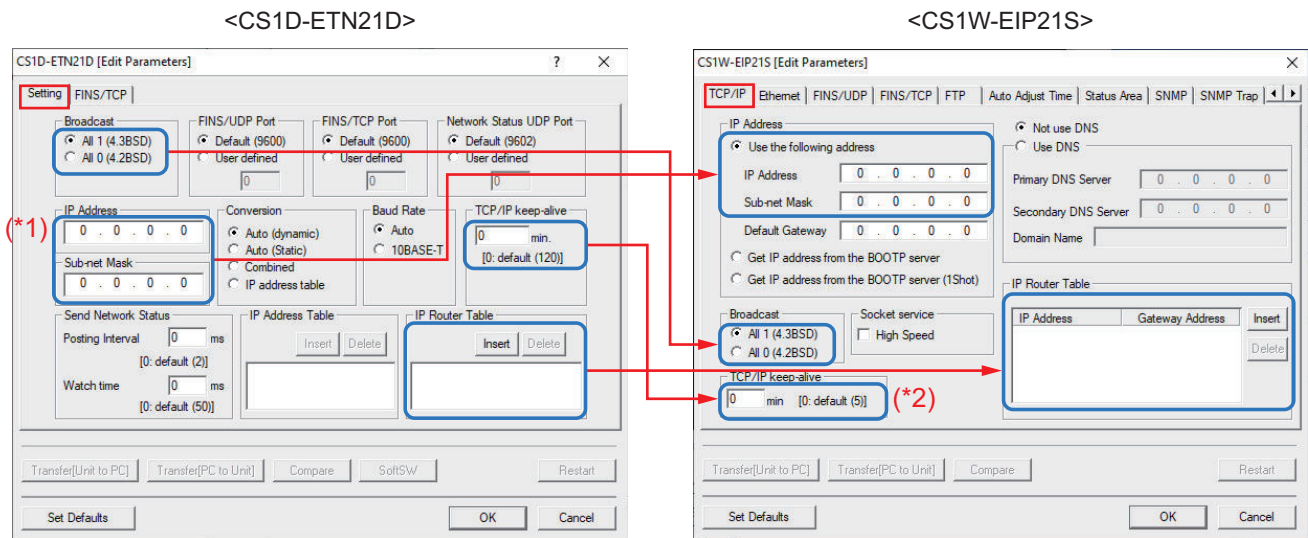

(*1) If the IP address is all zeros, it means that the data is set in the DM Area.

In this case, check the allocated DM Area words (m+98, m+99) against the data that you read from the DM Area to see if the intended IP address is set.

If both this setting and the address read from the DM Area are zeros, set the following IP addresses in the Unit Setup or in the DM Area.

- Unit with unit number N: 192.168.250.Node_address
- Unit with unit number N+1: 192.168.251.Node_address

(*2) The default keep-alive value is different. Change the default value, if used, to 120 min. Enter 120.

● Setting Tab Page to Ethernet Tab Page

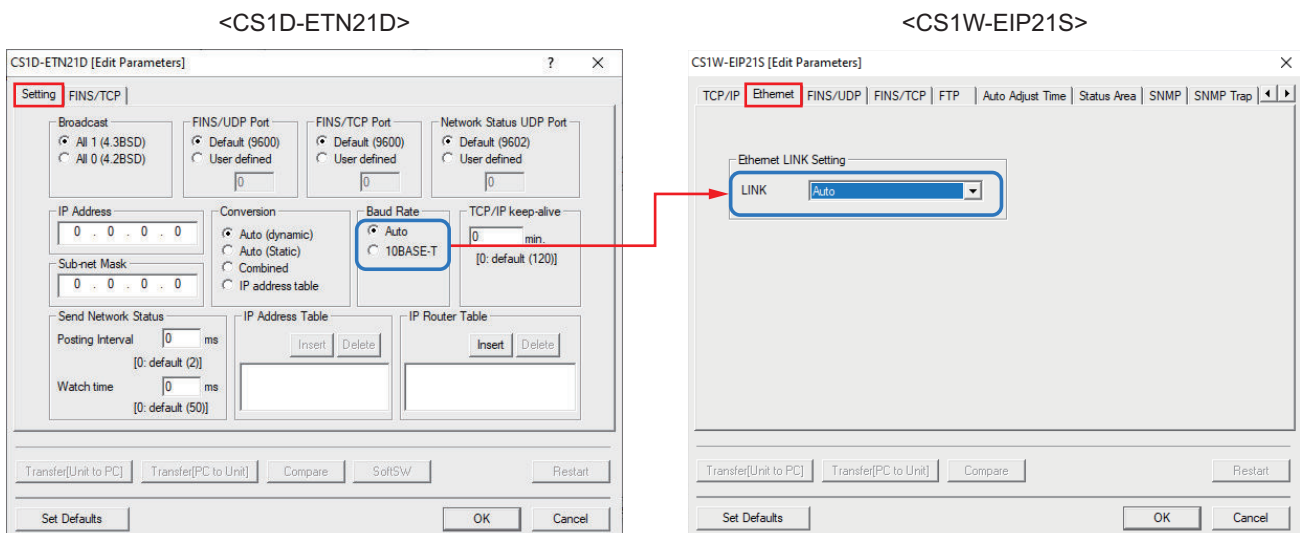

● **Setting Tab Page to FINS/UDP Tab Page**

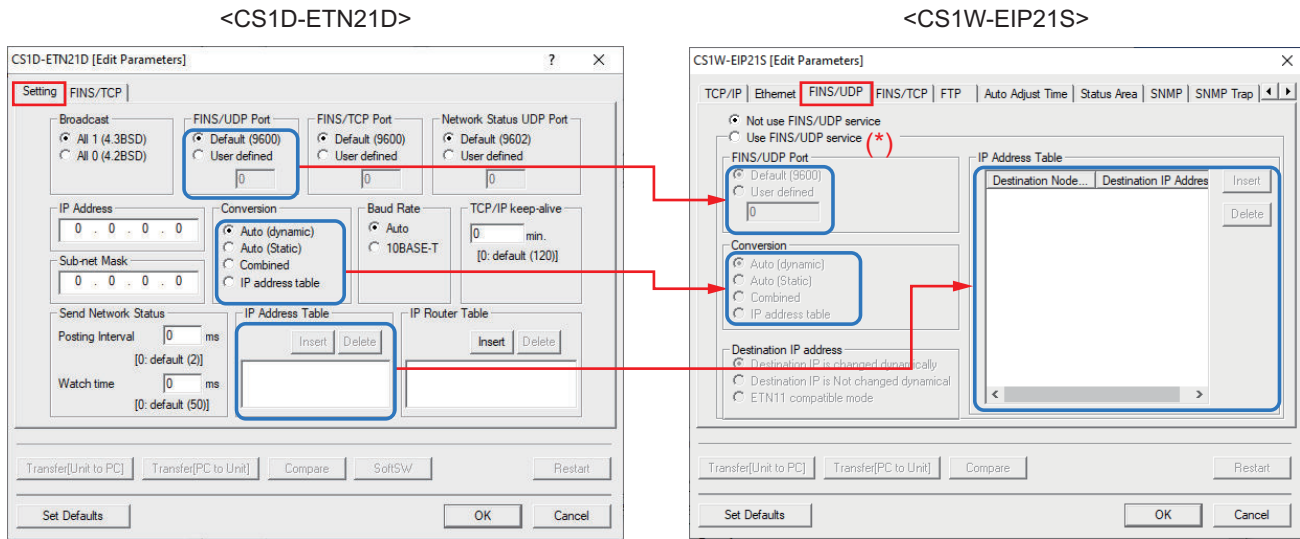

(*) The source replacement model does not have the settings for using or not using the FINS/UDP service and, by default, you can use this service. Therefore, select the **Use FINS/UDP service** Check Box.

● **Setting Tab Page to FINS/TCP Tab Page**

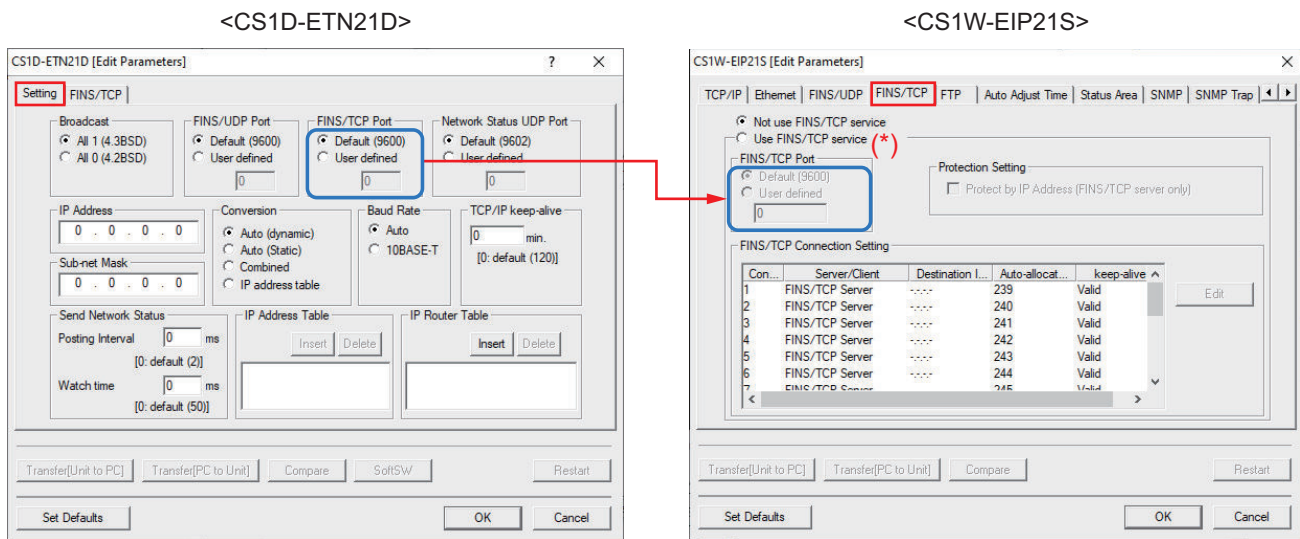

(*) The source replacement model does not have the settings for using or not using the FINS/TCP service and, by default, you can use this service. Therefore, select the **Use FINS/TCP service** Check Box.

● **No Settings to Move from the Setting Tab Page**

The **Network Status UDP Port**, **Send Network Status: Posting Interval**, and **Send Network Status: Watch time** cannot be set for the CS1W-EIP21S.

These settings are for duplex communications of the CS1D-ETN21D. They are not described in this manual because duplex communications are configured by the user program.

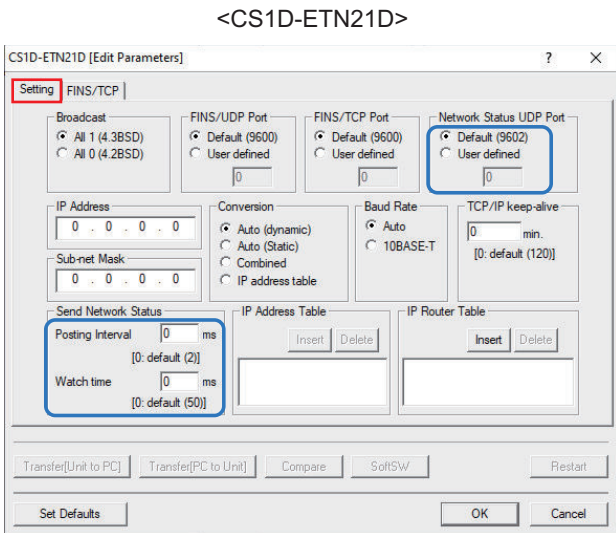

<CS1W-EIP21S>

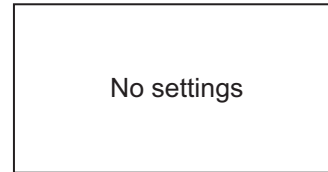

Moving the Settings from the FINS/TCP Tab Page

Move the settings from the **FINS/TCP** Tab Page for the CS1D-ETN21D to the corresponding locations in the specified tab page for the CS1W-EIP21S as shown below.

<CS1D-ETN21D>

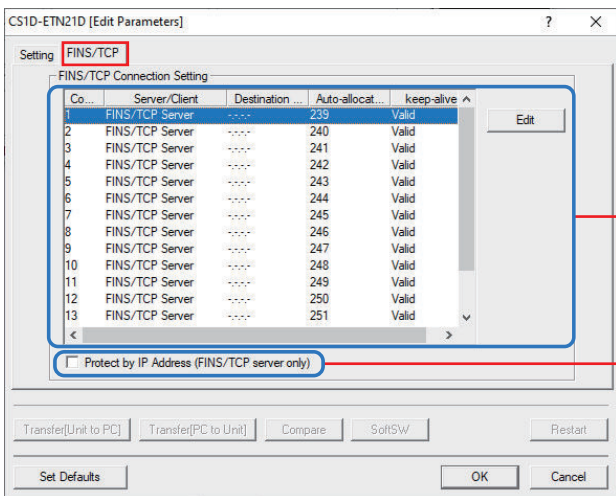

<CS1W-EIP21S>

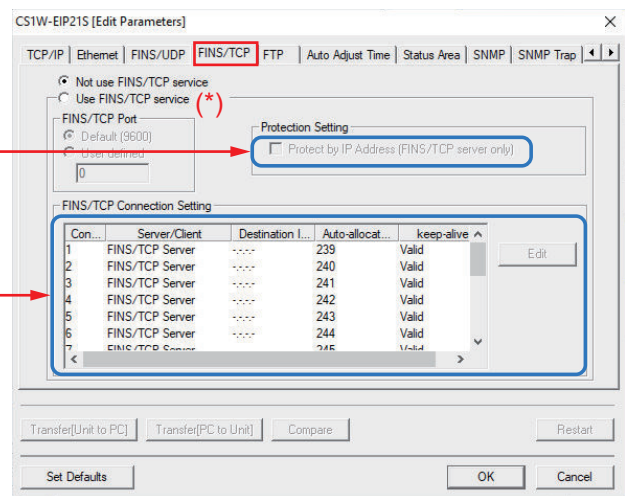

(*) The source replacement model does not have the settings for using or not using the FINS/TCP service and, by default, you can use this service. Therefore, select the **Use FINS/TCP service** Check Box.

5-3-9 Editing PLC Settings

Use the CX-Programmer to edit the PLC settings. Disable duplex communications.

In addition, configure the following settings as required to deal with the restrictions on replacement.

- **Power Off Detection Time**

The following topics describe these settings.

Duplex Communications

If duplex communications are enabled for the CS1D-ETN21D, the check box for the Communications Unit is selected in the Primary-Secondary area, as shown below.

Clear this check box to replace it with the CS1W-EIP21S.

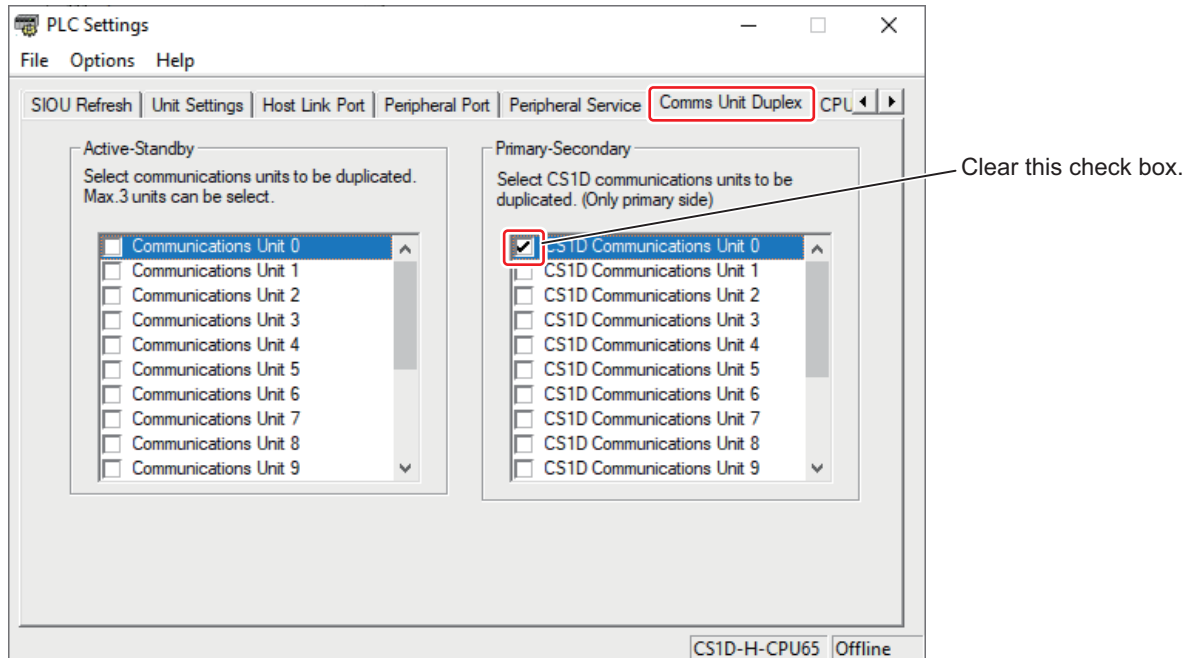

Power OFF Detection Time

Set this according to *Setting the Power OFF Detection Time* on page 2-37 in 2-3-8 *Setting Up the CPU Unit* on page 2-36.

5-3-10 Editing the User Program

In this case of replacement, you need to edit the user program for the following items.

Item	Description	Reference
Creating a Duplex Communications Program	Although the CS1D-ETN21D automatically performs duplex communications, the CS1W-EIP21S uses a user program to do so.	<i>Creating a Duplex Communications Program</i> on page 5-19
Editing the User Program Due to Differences in Allocated CIO Area and DM Area Words	There are differences in the allocated CIO Area and DM Area words between the source and target replacement models. You need to edit the user program according to the differences.	<i>Editing the User Program Due to Differences in Allocated CIO Area and DM Area Words</i> on page 5-20

The following topics describe these settings.

Creating a Duplex Communications Program

Although the CS1D-ETN21D automatically performs duplex communications, with the CS1W-EIP21S, you need to use a user program to do so. Here, the concept of the program is described to help you create a duplex communications program.

Understand this concept before you create a duplex communications program. Refer to *A-1 Duplex Communications Sample Programming* on page A-2 for sample programming for the duplex communications program.

● Concept of a Duplex Communications Program

Here, the concept of the communication method for duplex communications is described.

As shown in the figure below, the CPU Unit normally uses one of its networks (Network M) to send DATA A to the other PLC.

In this method, the CPU Unit checks the send result (response) and, if the response is normal, uses the same network (Network: M) to continue the communications with the PLC.

If the response is abnormal, the CPU Unit switches to the other network (Network: N) and sends DATA A to the other PLC.

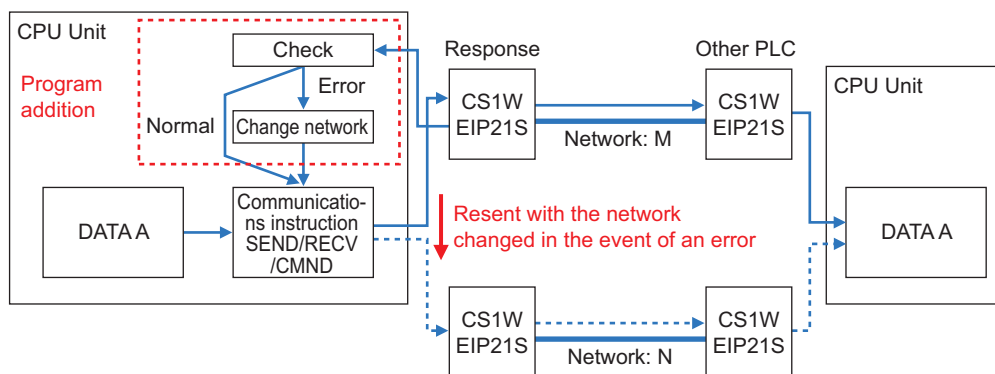

For the CS1D CPU Unit, the following flags are used to achieve this method.

- Communications Port Enabled Flags (A202.00 to A202.07)
- Communications Port Error Flags (A219.00 to A219.07)

The operation of these flags is described below.

- Executing a communications instruction sets the Communications Port Enabled Flags (A202.00 to A202.07) for the internal logical ports (No. 00 to 07) to 0 (OFF). ((A) in the figure)
- When the execution of the communications is completed, the Communications Port Enabled Flags (A202.00 to A202.07) change to 1 (ON).
If the execution of the communications is completed normally at this time, the Communications Port Error Flags (A219.00 to A219.07) are 0 (OFF). ((B) in the figure)
- If the execution of the communications is completed abnormally (i.e., an error occurs), the Communications Port Error Flags (A219.00 to A219.07) are 1 (ON). ((C) in the figure)
Based on these conditions, the CPU Unit switches to the other network to continue the communications in the event of an error.

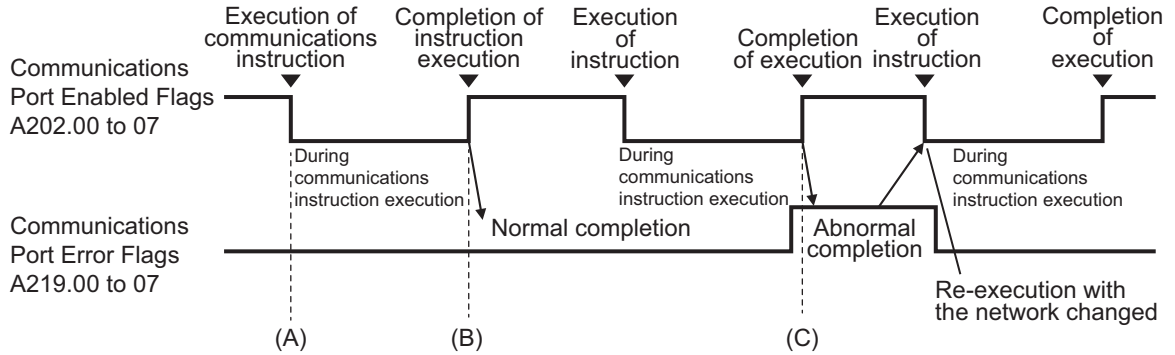

To switch the network, the destination network information in the control data for each communications instruction (SEND, RECV, or CMND) is changed to that of the other destination network, as shown below.

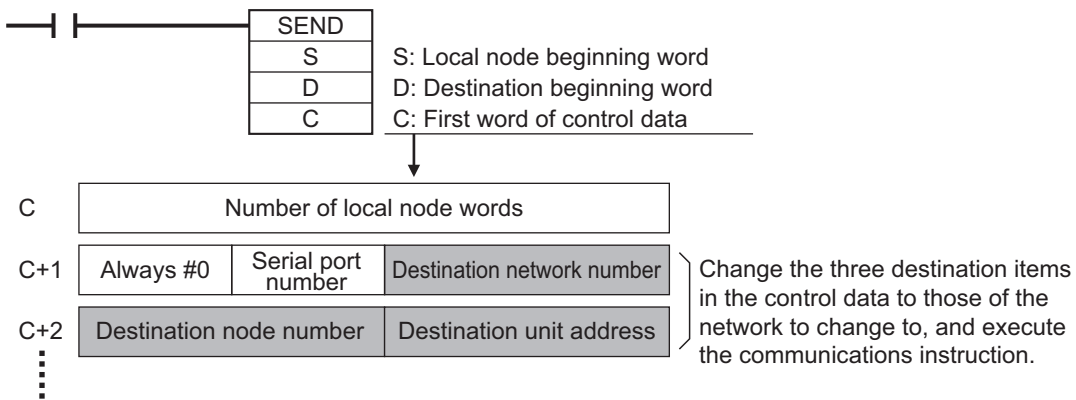

The network switching performance of the CS1W-ETN21D depends on the network status. The network switching performance of the CS1W-EIP21S depends on the response monitor time set to the control data of the duplex communications program.

Editing the User Program Due to Differences in Allocated CIO Area and DM Area Words

There are differences in the allocated CIO Area and DM Area words between the source and target replacement models. You need to edit the user program according to the differences.

The following topics describe the differences in allocated CIO Area words, the differences in the allocated DM Area words, the procedure for editing allocated CIO and DM Area words used by the user program, and procedure for editing the user program in other cases.

● Differences in Allocated CIO Area Words

The following shows the differences in the allocated CIO Area words.

Change the words and bits used by the user program according to the table below.

Word ^{*1}	CS1D-ETN21D		CS1W-EIP21S	Change description
n	Unit Control Bits ^{*2}		Unit Control Bits	---
n+1	Network Participation Status ^{*3}		Reserved	---
n+2			Target Node PLC Operating Information	---
n+3				
n+4				
n+5				
n+6			Target Node PLC Error Information	---
n+7				
n+8				
n+9				
n+10			Unit Status 1	---
n+11			Unit Status 2	---
n+12			Communications Status 1	---
n+13			Communications Status 2	The Service Status is reflected. However, an address change is required. The Duplex Status (bits 11 to 13) cannot be used.
n+14		Communications Status 3	The Error Status is reflected. However, an address change is required.	
n+15		Reserved	---	
n+16		Registered Target Node Table	---	
n+17	Service Status			
n+18	Error Status			
n+19	Memory Card Unit Setup Error Code ^{*2}			
n+20	Not used		Normal Target Node Table	---
n+21	Not used			
n+22	Not used			
n+23	FINS/TCP Connection Status			
n+24	Not used		FINS/TCP Connection Status	An address change is required. The bit configuration is the same.

*1. $n = 1500 + (25 \times \text{Unit number})$

*2. This word is for Memory Card Unit Setup and cannot be used. Delete the data if it is used by the user program.

*3. These words are for duplex communications and cannot be used. Delete the data if it is used by the user program.

● Differences in Allocated DM Area Words

The following shows the differences in the allocated DM Area words.

The CS1D-ETN21D uses only the IP Address Display/Setting Area, which is the same as that of the CS1W-EIP21S.

Word ^{*1}	CS1D-ETN21D		CS1W-EIP21S	Change description
m	Not used		Not used	---
m+1			Number of Bytes Received at TCP Socket No. 1 to 8	---
:				
m+8			TCP Socket No. 1 to 8 Connection Status	---
m+9				
:				
m+16			Socket Service Parameter Area 1 to 8	---
m+17				
m+18				
:				
m+96			D5 Error (Verification Error, Target Nonexistent) Mask Setting Area	---
m+97				
m+98	IP Address Display/Setting Area		IP Address Display/Setting Area	The address and the bit configuration are the same.
m+99				

*1. $m = D30000 + (100 \times \text{Unit number})$

● Editing Allocated CIO Area and DM Area Words Used by the User Program

Correct the allocated CIO Area and DM Area words.

Refer to *Editing the User Program* on page 4-23 in *4-3-9 Editing the User Program* on page 4-20 for details on the procedure.

● Editing the User Program in Other Cases

If indirect DM addresses or index registers are used, you cannot check indirect DM addresses and index registers in Detailed usage report.

Use the **Ctrl + F** Keys to display the search dialog box and check for the presence of *IR*, **D*, **E*, *@D*, *@E*, etc.

If any of them is present, check if the allocated CIO Area or DM Area words are specified.

5-3-11 Editing Allocated CIO Area or DM Area Words

● When Data Is Directly Written

There are cases where data is written directly to allocated CIO Area or DM Area words for use in setting data. In such cases, check that data is not written to the allocated CIO Area or DM Area words in the source replacement model. If data is written, move the data to the allocated CIO Area or DM Area words in the target replacement model.

If the IP address is set in the DM Area, check the allocated DM Area words (m+98, m+99) against the data that you read from the DM Area to see if the intended IP address is set.

If the address set in the Special Unit Setup and the address read from the DM Area are zeros, set the following IP addresses in the Special Unit Setup or in the DM Area.

- Unit with unit number N: 192.168.250.Node_address
- Unit with unit number N+1: 192.168.251.Node_address

The above settings in the DM Area are not required if you set them in the Special Unit Setup.

- **When Data Is Written/Read to/from the Allocation Area by Other Devices**

There are cases where data is written to allocated DM Area words by another device (HMI or computer) connected to the network. In such cases, change the location that the device writes to or reads from according to the changes in the allocated CIO Area or DM Area words due to replacement.

5-3-12 Saving the Project File

After completion of the edits, rename and save the project file.

File – Save As

5-4 Replacement

This section describes the actual replacement steps.

5-4-1 Replacing and Wiring Units

- 1** Back up the data before you perform replacement.
Taking into account the risk that you fail in replacement, perform simple backup with a Memory Card, or back up the PLC data with the PLC Backup Tool.
- 2** Turn OFF the power supply to the equipment.
- 3** Disconnect the cable from the CS1D-ETN21D and remove the Unit.
- 4** Mount the CS1W-EIP21S. Do not install the cable at this point. You will install it in the later operation check process.
Set the switches on the front panel as follows.
Unit number: Set one Unit to the same value as before replacement and the other Unit to the value added by 1.
Example: If the unit number before replacement is 0, set one Unit to 0 and the other Unit to 1.
Node address: Set both Units to the same value as before replacement.

5-4-2 Turning ON the Power Supply

Check the safety of the equipment and turn ON the power supply to the PLC after replacement.



Precautions for Correct Use

The C□1W-EIP21S requires a Unit startup time. For this reason, the CPU Unit startup time will be delayed by a few seconds compared with the system before replacement.

5-4-3 Resetting Errors

If duplex communications are enabled in the CS1D-ETN21D, a duplex communications error will occur in the Unit configuration after replacement when the power supply to the PLC is turned ON. This is due to the duplex communications settings in the PLC Settings Window. In addition, since the type of CPU Bus Unit is changed, a CPU Bus Unit setting error will occur. You cannot transfer the prepared data in this state. Therefore, you need to reset these errors.

Reset the duplex communications error and then reset the CPU Bus Unit setting error.

The following shows how to reset them.

Resetting Errors

Follow the steps below to reset an error.

Refer to the *CX-Programmer Ver. 9.□ Operation Manual (Cat. No. W446)* in addition to this manual for how to operate the CX-Programmer and connect the CPU Unit to the CX-Programmer. Refer also to the user's manual for your CPU Unit for how to connect the CPU Unit to the CX-Programmer.

- 1** Connect the computer to the peripheral port on the CPU Unit.
- 2** Start the CX-Programmer.
- 3** Connect the CX-Programmer online to the PLC and change to PROGRAM mode.
PLC – Work Online
PLC – Operating Mode – Program

- 4** Open the project data file that you created during preparation.
File – Open

At this time, check that the duplex communications settings are disabled in the PLC Settings Window.

Refer to *Duplex Communications* on page 5-18 for the duplex communications settings.

- 5** Transfer the PLC settings in the project data to the PLC.
PLC – Transfer – To PLC

(1) Select the Settings Check Box.

(2) Click the **OK** Button.

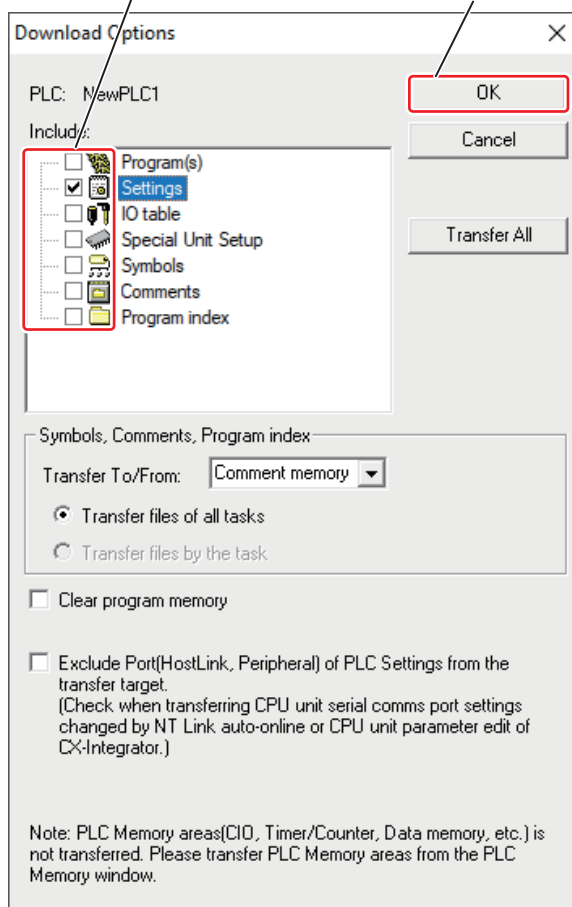

- 6** Place the CX-Programmer offline and turn OFF the power supply to the PLC. Then, turn it ON again.

The duplex communications error is reset. The CPU Bus Unit setting error still persists in this state. Continue to reset the CPU Bus Unit setting error.

- 7** Connect the CX-Programmer online to the PLC and change to PROGRAM mode.

PLC – Work Online

PLC – Operating Mode – Program

- 8** Transfer the I/O table in the project data to the PLC.

PLC – Transfer – To PLC

(1) Select the IO table Check Box.

(2) Click the **OK** Button.

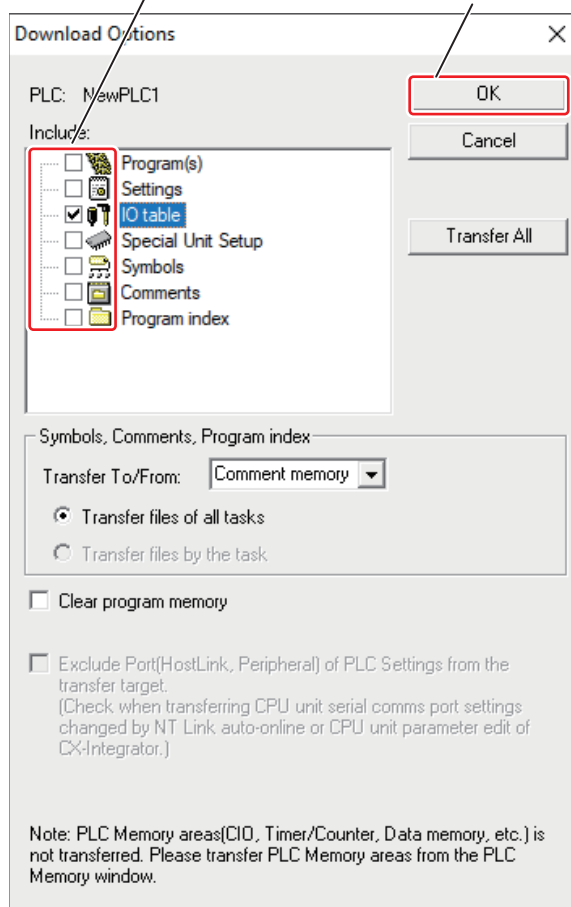

The CPU Bus Unit setting error is reset.

5-4-4 Transferring Data (to PLC)

From the Support Software connected directly to the peripheral port on the CPU Unit, transfer the following data that you prepared to the actual PLC after replacement.

- PLC project data
- Routing table

Transferring PLC Project Data (to PLC)

Transfer the PLC project data that you created to match the Unit configuration after replacement during preparation to the actual PLC. To do so, connect the CX-Programmer directly to the peripheral port on the CPU Unit and place it online.

The following is the PLC project data to transfer. Note that there is no need to transfer data that was not edited during preparation.

- User program
- PLC settings
- I/O table
- Special Unit settings
- DM Area information

Transfer PLC project data according to *Transferring PLC Project Data* on page 2-50 in 2-4-3 *Transferring Data* on page 2-49.

Transferring the Routing Table (to PLC)

Transfer the routing table to the PLC if it is edited in the Unit configuration after replacement. To do so, connect the CX-Integrator to the peripheral port on the CPU Unit and place it online.

● Transferring the Routing Table

The following shows how to transfer the routing table to a PLC with the CX-Integrator.

Refer to the *CS/CJ/CP/NSJ-series CX-Integrator Ver. 2.□ Operation Manual (Cat. No. W464)* in addition to this manual for how to transfer the routing table.

- 1** Connect the CX-Programmer online to the PLC and open the I/O table.
- 2** Click the CPU Unit and Start the CX-Integrator.
Options – Start Special Application – Start with Settings Inherited

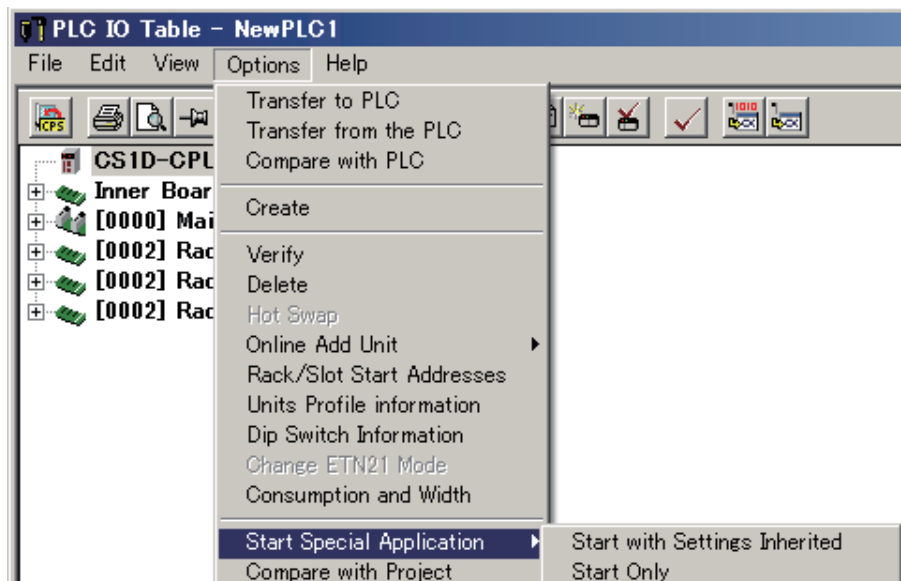

- 3** In the dialog box displayed, select the port connected to the PLC and click the **OK** Button.

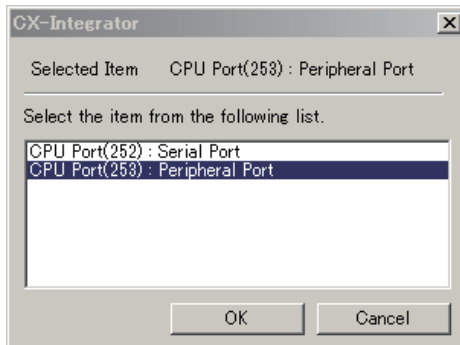

- 4** In the dialog box displayed, select **Network structure only** and click the **Transfer** Button.

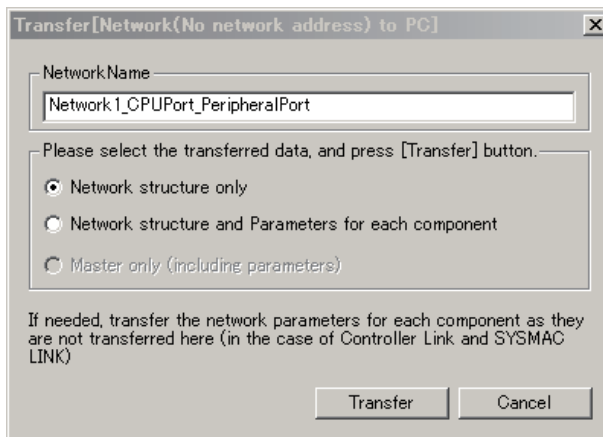

The following image is displayed.

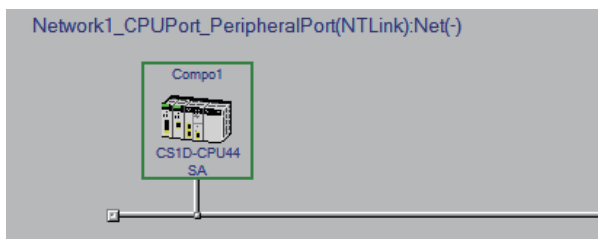

- 5** Start the Routing Table Component.
Tools – Start Routing table

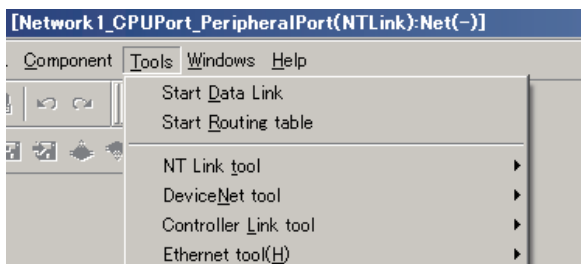

- 6** Read the routing table that you created during preparation.

File – Open Local Routing Table File

- 7** Click the **Transfer to the PLC** icon.

Click the **Transfer to the PLC** icon.

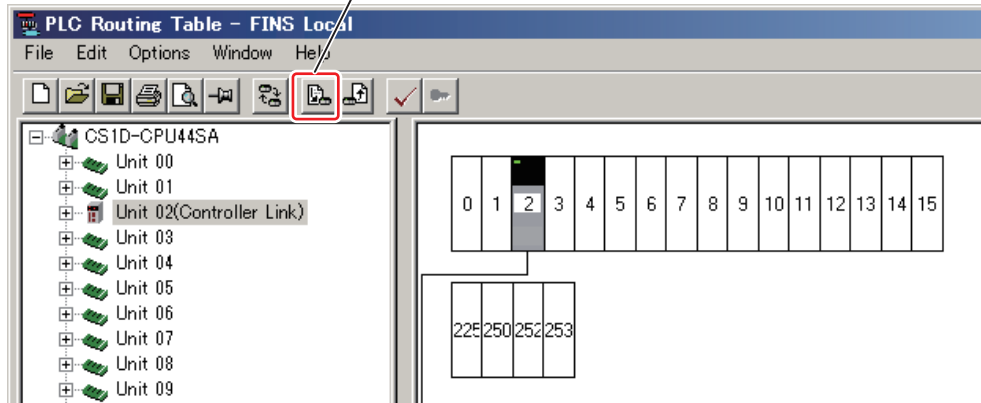

The following view is displayed. Click the **Yes** Button.

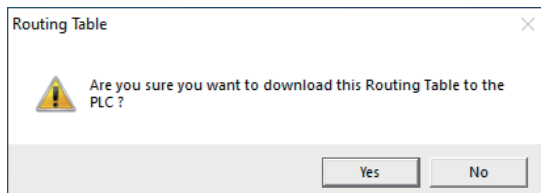

The following dialog box is displayed. The transfer is now completed.

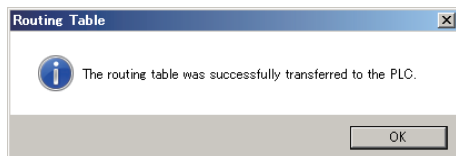

5-4-5 Checking the Operation

- 1** Turn OFF the power supply to the PLC.
- 2** Install the cable to the CS1W-EIP21S.
- 3** Check the safety of the equipment and turn ON the power supply to the PLC.
- 4** Confirm that the equipment operates as intended.

Refer to the user's manual for your Unit for the operation check and troubleshooting procedures for each Unit.

5-4-6 Implementing Security Measures

If necessary, implement measures to reduce the security risks from external attacks before the start of system operation after replacement. We recommend that you set user authentication and use secure

communications (Secure Comm) to connect the Support Software online to the C□1W-EIP21S Ether-Net/IP port.

In addition to user authentication and secure communications (Secure Comm), the C□1W-EIP21S and Support Software provide other security functions to reduce security risks. Use these security functions in conjunction with system operation to further reduce the security risks.

For details, refer to *2-4-5 Implementing Security Measures* on page 2-55.

5-4-7 Checking the Operation after Implementing Security Measures

After you implement security measures, check to be sure that the system operates according to the security settings.



Appendices

This section describes duplex communications sample programming.

A-1	Duplex Communications Sample Programming	A-2
A-1-1	System Configuration	A-2
A-1-2	Sample Programming.....	A-2

A-1 Duplex Communications Sample Programming

This appendix provides duplex communications sample programming for a system with the target replacement model CS1W-EIP21S.

The duplex communications sample programming is presented in a way to show differences between the system with the source replacement model CS1D-ETN21D and the system with the target replacement model CS1W-EIP21S.



Precautions for Correct Use

The CS1W-EIP21S does not support the duplex network function supported by the CS1D-ETN21D. To replace the CS1D-ETN21D that uses duplex network with the CS1W-EIP21S, you need to create a duplex network program.

Create the program so that the duplex system specifications before replacement are satisfied. After replacement, perform a thorough duplex system evaluation to check that the duplex system specifications are satisfied.

Refer to *Creating a Duplex Communications Program* on page 5-19 for creating a duplex network program.

A-1-1 System Configuration

The figures below show the system configuration with the CS1D-ETN21D and the system configuration with the CS1W-EIP21S.

<System Configuration with the CS1D-ETN21D>

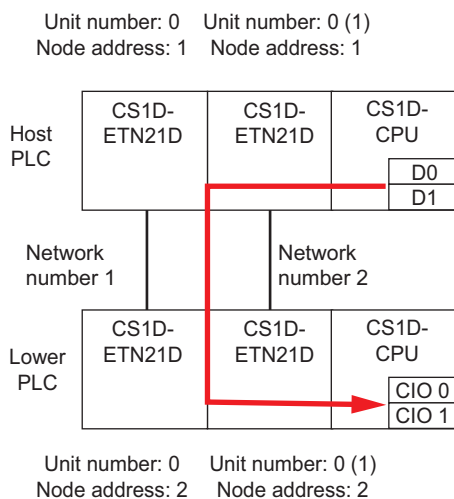

<System Configuration with the CS1W-EIP21S>

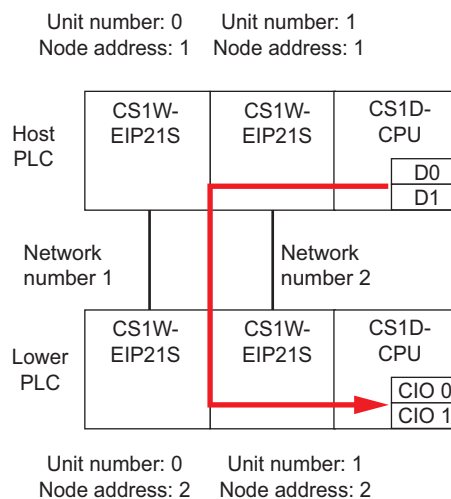

A-1-2 Sample Programming

This section provides a programming example for using a SEND instruction to transfer data from D0 to D1 of the host PLC to CIO 0 to CIO 1 of the lower PLC.

Sample programming for the source replacement model CS1D-ETN21D and sample programming for the target replacement model CS1W-EIP21S are shown below.

Duplex communications are achieved by adding a network switching program to the user program for the source replacement model CS1D-ETN21D.

The network switching program switches communications to another network if it is not possible to communicate with a network.

The sample programming example sets the response monitor time to 200 ms. The network switching performance depends on the response monitor time. After replacement, perform a thorough duplex system evaluation and set the monitor time.

Sample Programming for the CS1D-ETN21D

The figure below shows sample programming for the source replacement model CS1D-ETN21D. Add a network switching program to the location shown in the figure to make it available for the CS1W-EIP21S.

Refer to *Sample Programming for the CS1W-EIP21S* on page A-4 for sample programming for the CS1W-EIP21S.

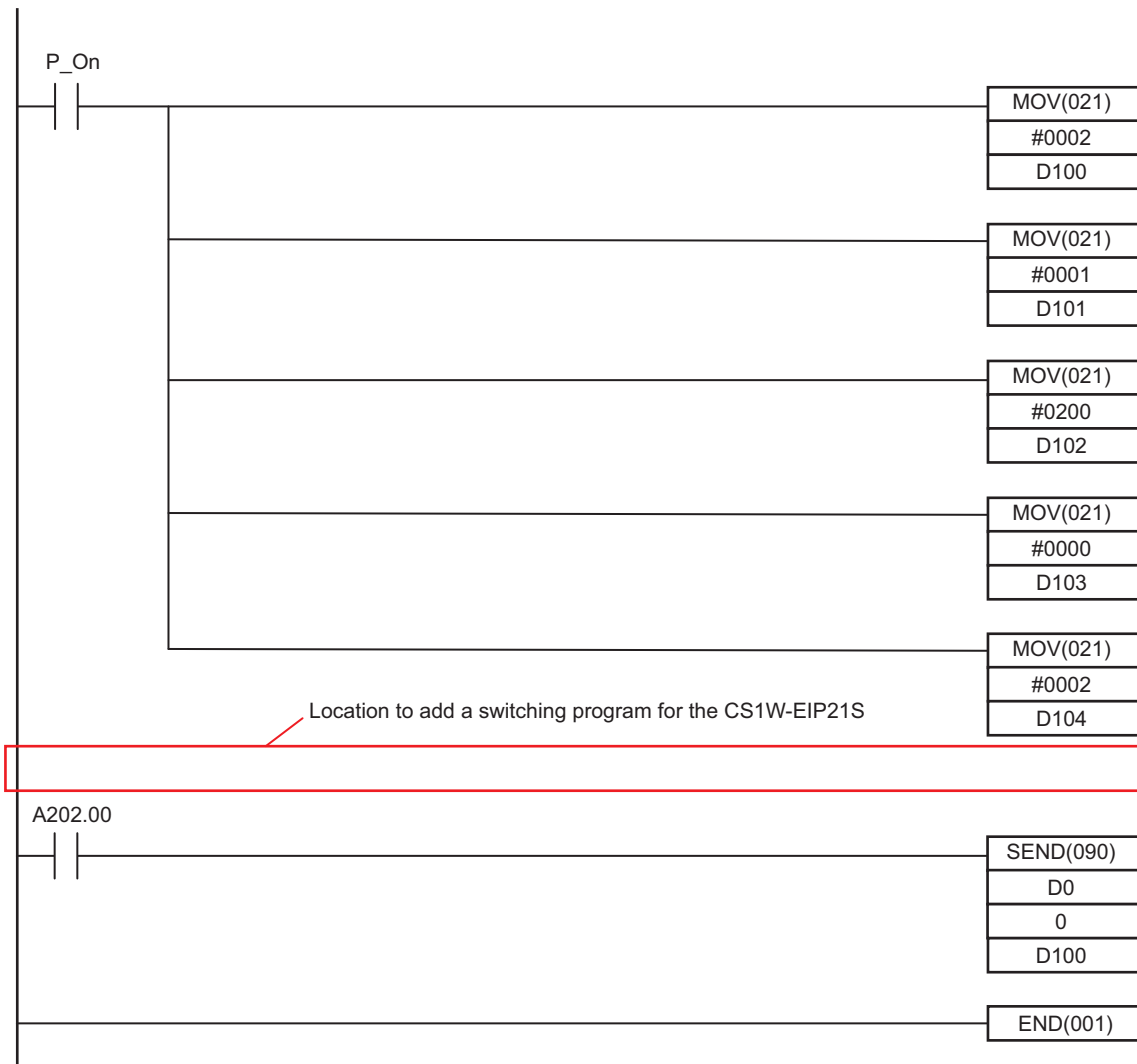

The meaning of data used in the program is shown below.

Data	Meaning
D0 to D1	Local node send words

Data	Meaning
0 to 1	Destination reception words
D100 to D104	SEND instruction control data
A202.00	Communications Port Enabled Flag

Sample Programming for the CS1W-EIP21S

The figure below shows sample programming for the target replacement model CS1W-EIP21S.

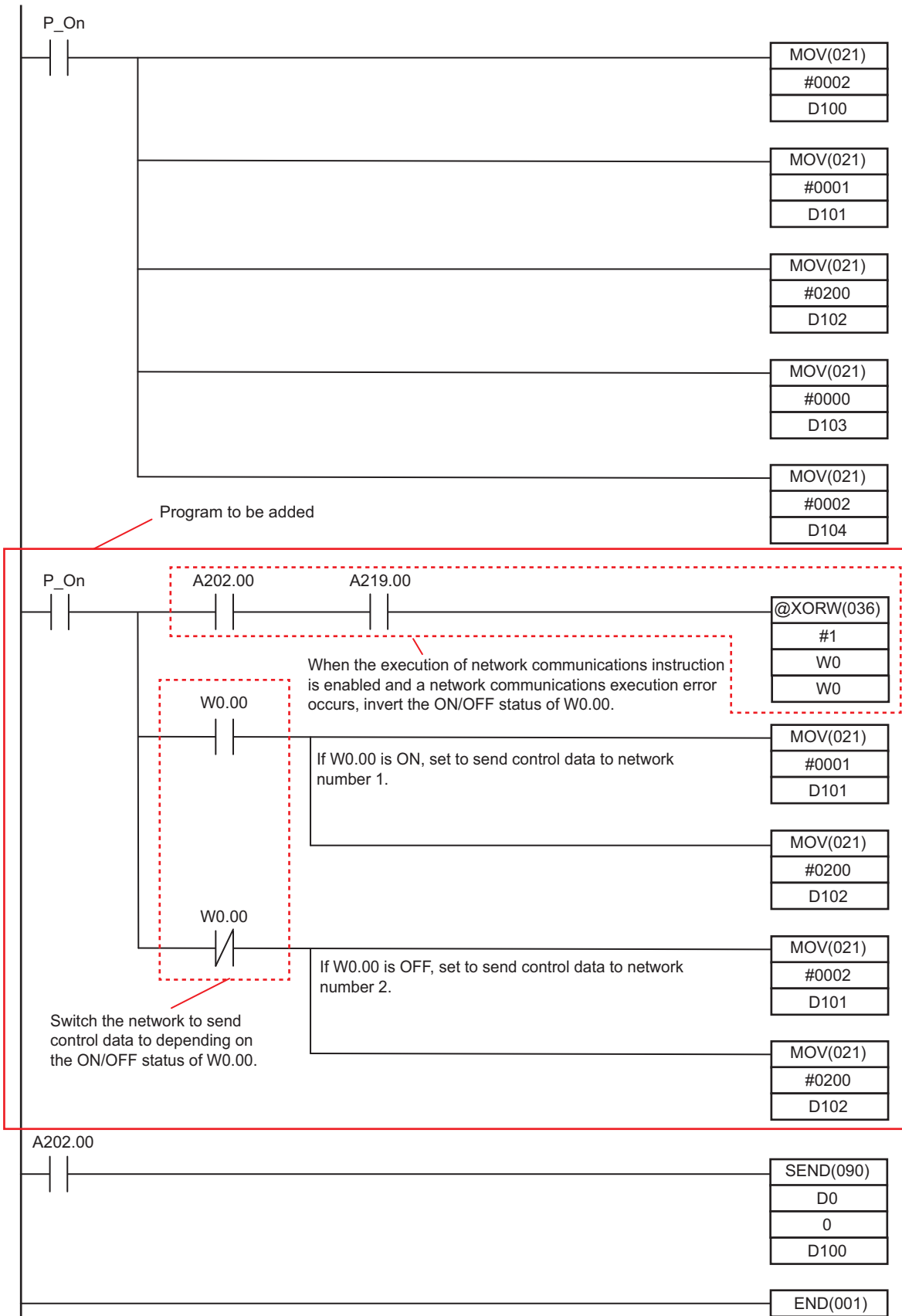

The meaning of data used in the program is shown below.

Data	Meaning
D0 to D1	Local node send words

Data	Meaning
0 to 1	Destination reception words
D100 to D104	SEND instruction control data
A202.00	Communications Port Enabled Flag
A219.00	Communications Port Error Flag
W0.00	Network switching flag at communications error <ul style="list-style-type: none"> • ON: Send control data to network number 1. • OFF: Send control data to network number 2.

The operation of the sample programming is shown below.

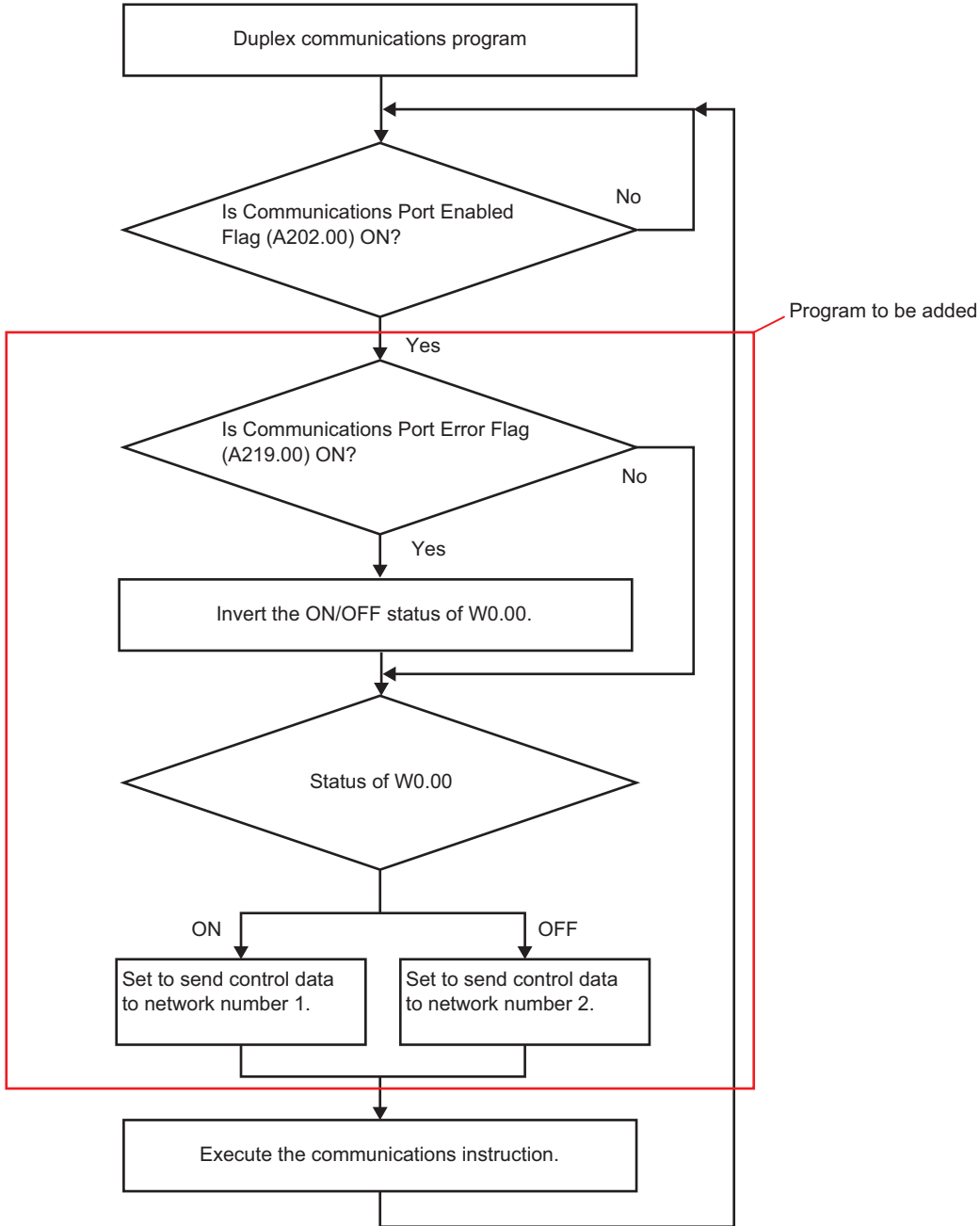



Index



Index

- C**
- checking the dimensions..... 2-34
 - correcting PLC memory..... 2-42
 - correcting the PLC settings..... 2-36
 - CP1H-series CPU Units..... 1-9, 1-11
 - creating a duplex communications program..... 5-19
 - CX-One..... 1-13
- D**
- dealing with restrictions..... 2-37
 - differences in allocated CIO Area words..... 4-20, 5-20
 - differences in allocated DM Area words..... 4-22, 5-21
 - differences in EtherNet/IP port memory allocation... 2-6, 2-14
 - differences in memory allocation..... 3-8
 - downloading tag data link parameters..... 2-55, 3-18
 - duplex communications..... 5-18
 - duplex Ethernet network..... 5-2
- E**
- editing allocated CIO and DM Area words used by the user program..... 5-22
 - editing the user program..... 4-23
 - editing the user program in other cases..... 4-25, 5-22
 - EtherNet/IP Unit or built-in EtherNet/IP port..... 1-2
- F**
- function blocks for socket services..... 4-26
- G**
- getting an IP address from the BOOTP server..... 2-39
- O**
- overview of security measures..... 2-58
- P**
- power OFF detection time..... 4-19, 5-18
- R**
- reading PLC project data (from PLC)..... 2-20, 4-9, 5-9
 - reading the routing table (from PLC)..... 2-23, 5-10
 - reading the settings of Units that use the CPU Bus Unit Setup Area..... 2-26
 - replacement when a Serial Option Board is used..... 1-7
 - resetting errors..... 5-24
 - restrictions..... 2-7, 2-15, 3-9
 - restrictions on the power supply..... 2-32
- S**
- Serial Option Board..... 1-5
 - setting for using socket services..... 4-19
 - setting the power OFF detection time..... 2-37
 - setting up the C□1W-EIP21S..... 2-39
 - setting up Units that use the CPU Bus Unit Setup Area.. 2-42
 - setting user authentication..... 2-56
 - Special Unit settings..... 2-41
 - system with the CJ2H-CPU6□-EIP..... 1-3
 - system with the CJ2M-CPU3□..... 1-5
- T**
- transferring PLC project data (to PLC)..... 2-49, 3-18, 5-27
 - transferring the routing table (to PLC)..... 2-52, 5-27
 - transferring the settings of Units that use the CPU Bus Unit Setup Area..... 2-55
- U**
- Unit startup time..... 2-8, 2-15, 3-9, 4-3, 5-4
 - uploading tag data link parameters..... 2-23
 - use restriction on the Power Supply Unit..... 2-8, 2-15, 3-9, 4-3, 5-4
 - using an I/O table to calculate the current consumption and Unit width..... 2-34

Note: Do not use this document to operate the Unit.

OMRON Corporation Industrial Automation Company

Kyoto, JAPAN

Contact : www.ia.omron.com

Regional Headquarters

OMRON EUROPE B.V.

Wegalaan 67-69, 2132 JD Hoofddorp
The Netherlands

Tel: (31) 2356-81-300 Fax: (31) 2356-81-388

OMRON ASIA PACIFIC PTE. LTD.

438B Alexandra Road, #08-01/02 Alexandra
Technopark, Singapore 119968

Tel: (65) 6835-3011 Fax: (65) 6835-2711

OMRON ELECTRONICS LLC

2895 Greenspoint Parkway, Suite 200
Hoffman Estates, IL 60169 U.S.A.

Tel: (1) 847-843-7900 Fax: (1) 847-843-7787

OMRON (CHINA) CO., LTD.

Room 2211, Bank of China Tower,
200 Yin Cheng Zhong Road,
PuDong New Area, Shanghai, 200120, China

Tel: (86) 21-5037-2222 Fax: (86) 21-5037-2200

Authorized Distributor:

©OMRON Corporation 2023 All Rights Reserved.
In the interest of product improvement,
specifications are subject to change without notice.

Cat. No. P152-E1-01 0723