

Machine Automation Controller

NJ-series

## SECS/GEM CPU Units

User's Manual

NJ501-1340

CPU Unit



## NOTE

1. All rights reserved. No part of this publication may be reproduced, stored in a retrieval system, or transmitted, in any form, or by any means, mechanical, electronic, photocopying, recording, or otherwise, without the prior written permission of OMRON.
2. No patent liability is assumed with respect to the use of the information contained herein. Moreover, because OMRON is constantly striving to improve its high-quality products, the information contained in this manual is subject to change without notice.
3. Every precaution has been taken in the preparation of this manual. Nevertheless, OMRON assumes no responsibility for errors or omissions. Neither is any liability assumed for damages resulting from the use of the information contained in this publication.

## Trademarks

- Sysmac and SYSMAC are trademarks or registered trademarks of OMRON Corporation in Japan and other countries for OMRON factory automation products.
- Microsoft, Windows, Excel, Visual Basic, and Microsoft Edge are either registered trademarks or trademarks of Microsoft Corporation in the United States and other countries.
- EtherCAT® is registered trademark and patented technology, licensed by Beckhoff Automation GmbH, Germany.
- ODVA, CIP, CompoNet, DeviceNet, and EtherNet/IP are trademarks of ODVA.
- The SD and SDHC logos are trademarks of SD-3C, LLC. 

Other company names and product names in this document are the trademarks or registered trademarks of their respective companies.

## Copyrights

- Microsoft product screen shots used with permission from Microsoft.
- This product incorporates certain third party software. The license and copyright information associated with this software is available at [http://www.fa.omron.co.jp/nj\\_info\\_e/](http://www.fa.omron.co.jp/nj_info_e/).

# Introduction

---

Thank you for purchasing an NJ-series CPU Unit.

This manual contains information that is necessary to use the NJ-series CPU Unit. Please read this manual and make sure you understand the functionality and performance of the NJ-series CPU Unit before you attempt to use it in a control system.

Keep this manual in a safe place where it will be available for reference during operation.

## Intended Audience

This manual is intended for the following personnel, who must also have knowledge of electrical systems (an electrical engineer or the equivalent).

- Personnel in charge of introducing FA systems.
- Personnel in charge of designing FA systems.
- Personnel in charge of installing and maintaining FA systems.
- Personnel in charge of managing FA systems and facilities.

This manual is intended also for personnel with the following knowledge.

- For programming, the programming language specifications in international standard IEC 61131-3 or Japanese standard JIS B 3503
- The contents of the SEMI E5, SEMI E30, and SEMI E37 documents

## Applicable Products

This manual covers the following products.

- NJ-series SECS/GEM CPU Unit
  - NJ501-1340
- Sysmac Studio Automation Software
  - SYSMAC-SE2□□□ version 1.10 or higher
- GEM Setting Tools, SECS/GEM Configurator
  - WS02-GCTL1

Part of the specifications and restrictions for the CPU Units are given in other manuals. Refer to *Relevant Manuals* on page 2 and *Related Manuals* on page 23.

# Relevant Manuals

The following table provides the relevant manuals for the NJ-series CPU Units.

Read all of the manuals that are relevant to your system configuration and application before you use the NJ-series CPU Unit.

Most operations are performed from the Sysmac Studio Automation Software. Refer to the *Sysmac Studio Version 1 Operation Manual* (Cat. No. W504) for information on the Sysmac Studio.

Purpose of use	Manual											
	Basic information											
	NJ-series CPU Unit Hardware User's Manual	NJ-series CPU Unit Software User's Manual	NJ/NX-series CPU Unit Reference Manual	NJ/NX-series Instructions Reference Manual	NJ/NX-series Motion Control User's Manual	NJ/NX-series Motion Control Instructions Reference Manual	NJ/NX-series CPU Unit Built-in EtherCAT Port User's Manual	NJ/NX-series CPU Unit Built-in EtherNet/IP Port User's Manual	NJ/NX-series CPU Unit User's Manual	NJ-series Database Connection CPU Unit User's Manual	NJ-series SECS/GEM CPU Unit User's Manual	NJ/NX-series Troubleshooting Manual
Introduction to NJ-series Controllers	●											
Setting devices and hardware												
Using motion control					●							
Using EtherCAT	●						●					
Using EtherNet/IP								●				
Using the database connection service									●			
Using GEM Services										●		
Software settings												
Using motion control					●							
Using EtherCAT		●					●					
Using EtherNet/IP								●				
Using the database connection service									●			
Using GEM Services										●		
Writing the user program												
Using motion control					●	●						
Using EtherCAT							●					
Using EtherNet/IP		●	●					●				
Using the database connection service									●			
Using GEM Services										●		
Programming error processing												●
Testing operation and debugging		●										
Using motion control					●							
Using EtherCAT							●					
Using EtherNet/IP								●				
Using the database connection service									●			
Using GEM Services										●		
Learning about error management and corrections*1	▲	▲			▲		▲	▲	▲	▲		●
Maintenance												
Using motion control	●				●							
Using EtherCAT							●					
Using EtherNet/IP								●				

\*1. Refer to the *NJ/NX-series Troubleshooting Manual* (Cat. No. W503) for the error management concepts and an overview of the error items. Refer to the manuals that are indicated with triangles for details on errors for the corresponding Units.



# Manual Structure

## Page Structure

The following page structure is used in this manual.

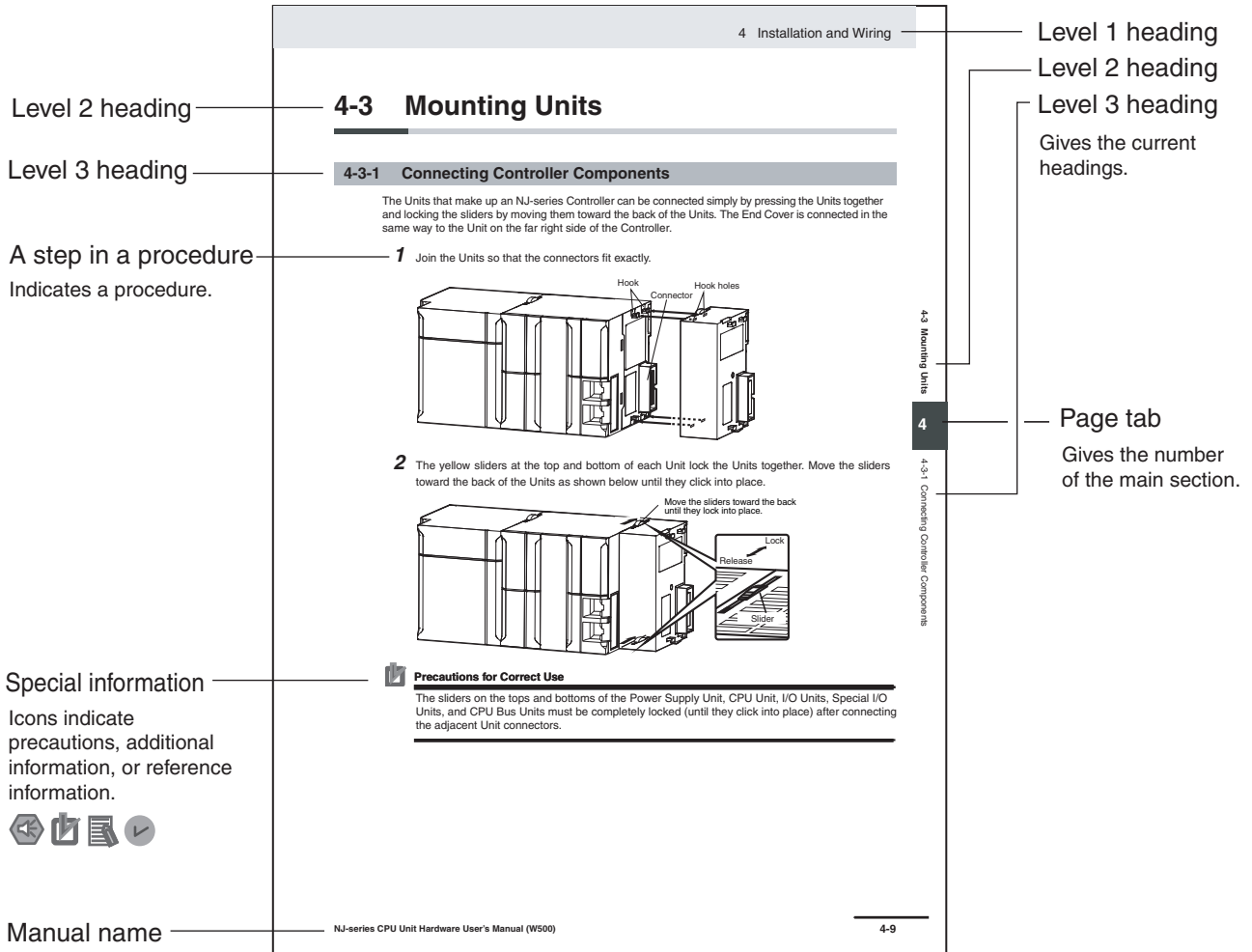

This illustration is provided only as a sample. It may not literally appear in this manual.

## Special Information

Special information in this manual is classified as follows:



### Precautions for Safe Use

Precautions on what to do and what not to do to ensure safe usage of the product.



### Precautions for Correct Use

Precautions on what to do and what not to do to ensure proper operation and performance.



### Additional Information

Additional information to read as required.

This information is provided to increase understanding or make operation easier.



### Version Information

Information on differences in specifications and functionality for CPU Units with different unit versions and for different versions of the Sysmac Studio is given.

Note References are provided to more detailed or related information.

## Precaution on Terminology

In this manual, “download” refers to transferring data from the Sysmac Studio to the physical Controller and “upload” refers to transferring data from the physical Controller to the Sysmac Studio.

For the Sysmac Studio, synchronization is used to both upload and download data. Here, “synchronize” means to automatically compare the data for the Sysmac Studio on the computer with the data in the physical Controller and transfer the data in the direction that is specified by the user.

The streams and functions that are defined in SEMI E5-0707 (*SEMI Equipment Communications Standard 2 Message Content (SECS-II)*) are given as follows:

*Function\_name (Sstream\_number,Function number)*

Example: Abort Transaction (S1,F0)

# Sections in this Manual

<b>1</b>	SECS/GEM CPU Unit Capabilities	<b>A</b>	Appendices	<b>1</b>	<b>A</b>
<b>2</b>	System Configuration and Functional Configuration	<b>I</b>	Index	<b>2</b>	<b>I</b>
<b>3</b>	GEM Service Design Procedure			<b>3</b>	
<b>4</b>	Functions Related to All GEM Services			<b>4</b>	
<b>5</b>	Host Connection Function			<b>5</b>	
<b>6</b>	GEM Service Logs			<b>6</b>	
<b>7</b>	Functionality Other Than the GEM Services			<b>7</b>	
<b>8</b>	SECS/GEM Configurator			<b>8</b>	
<b>9</b>	Troubleshooting			<b>9</b>	

# CONTENTS

---

<b>Introduction .....</b>	<b>1</b>
Intended Audience .....	1
Applicable Products .....	1
<b>Relevant Manuals .....</b>	<b>2</b>
<b>Manual Structure .....</b>	<b>3</b>
Special Information .....	4
<b>Sections in this Manual .....</b>	<b>5</b>
<b>Terms and Conditions Agreement .....</b>	<b>12</b>
Warranty, Limitations of Liability .....	12
Application Considerations .....	13
Disclaimers .....	13
Statement of security responsibilities for assumed use cases and against threats .....	14
<b>Safety Precautions .....</b>	<b>16</b>
<b>Precautions for Safe Use .....</b>	<b>17</b>
<b>Precautions for Correct Use .....</b>	<b>18</b>
<b>Regulations and Standards .....</b>	<b>20</b>
<b>Versions .....</b>	<b>21</b>
Types of Versions .....	21
Checking Versions .....	21
Unit Versions of CPU Units and Sysmac Studio Versions .....	22
<b>Related Manuals .....</b>	<b>23</b>
<b>Terminology .....</b>	<b>25</b>
<b>Revision History .....</b>	<b>27</b>

## Section 1      **SECS/GEM CPU Unit Capabilities**

---

<b>1-1 SECS/GEM CPU Unit Features .....</b>	<b>1-2</b>
<b>1-2 Standard Compliance of the SECS/GEM CPU Unit .....</b>	<b>1-4</b>
1-2-1 SEMI Standard Compliance .....	1-4
1-2-2 SECS/GEM Standard Compliance .....	1-4
1-2-3 Supported SECS Messages .....	1-5

## Section 2      **System Configuration and Functional Configuration**

---

<b>2-1 System Configuration .....</b>	<b>2-2</b>
<b>2-2 Functional Configuration of SECS/GEM CPU Unit .....</b>	<b>2-5</b>
<b>2-3 Overview of GEM Service Operation .....</b>	<b>2-7</b>
2-3-1 SECS Messages When Host Sends the Primary Message .....	2-7
2-3-2 SECS Messages When Equipment Sends the Primary Message .....	2-11
2-3-3 Link Variables .....	2-14

## Section 3 GEM Service Design Procedure

<b>3-1</b>	<b>Overview of GEM Service Design Procedure .....</b>	<b>3-2</b>
<b>3-2</b>	<b>Using the SECS/GEM Configurator to Create the GEM Setting Data .....</b>	<b>3-4</b>
<b>3-3</b>	<b>Using the Sysmac Studio to Create the SECS/GEM Operation Programming .....</b>	<b>3-6</b>
3-3-1	Starting the Sysmac Studio and Creating a Project.....	3-6
3-3-2	FTP Settings .....	3-7
3-3-3	Creating the SECS/GEM Operation Programming.....	3-7
3-3-4	Restrictions When Defining Link Variables for User-defined Variables .....	3-8
<b>3-4</b>	<b>Debugging.....</b>	<b>3-9</b>

## Section 4 Functions Related to All GEM Services

<b>4-1</b>	<b>Starting the GEM Services.....</b>	<b>4-2</b>
4-1-1	Procedure to Change the GEM Service Status to Run.....	4-2
4-1-2	Conditions That Prevent the GEM Service Status from Entering Run.....	4-2
<b>4-2</b>	<b>Ending the GEM Services .....</b>	<b>4-3</b>
4-2-1	Executing a Shutdown .....	4-3
4-2-2	Operation When Shutdown Processing Is Completed.....	4-3
<b>4-3</b>	<b>GEM Service Status.....</b>	<b>4-4</b>
4-3-1	GEM Service Status .....	4-4
4-3-2	Changes in the GEM Service Status .....	4-5
4-3-3	Checking the GEM Service Status .....	4-6
4-3-4	Relation between GEM Service Status and GEM Instructions.....	4-7

## Section 5 Host Connection Function

<b>5-1</b>	<b>Basic Processing of the Host Connection Function.....</b>	<b>5-3</b>
5-1-1	Starting and Pausing the Host Connection Function.....	5-3
5-1-2	Interlocks .....	5-5
5-1-3	Transaction Processing .....	5-6
5-1-4	Checking the Number of Buffered SECS Messages .....	5-12
<b>5-2</b>	<b>HSMS Communications .....</b>	<b>5-14</b>
5-2-1	Setting HSMS Conditions .....	5-14
5-2-2	HSMS Communications Connection States .....	5-15
5-2-3	Checking the HSMS Communications State .....	5-16
<b>5-3</b>	<b>Item Definitions.....</b>	<b>5-17</b>
<b>5-4</b>	<b>Variable Data Definitions .....</b>	<b>5-21</b>
5-4-1	Types of Variable Data.....	5-21
5-4-2	Link Variables for Variable Data.....	5-21
5-4-3	List Specifications for Variable Data .....	5-22
5-4-4	Standard Variable Data.....	5-24
<b>5-5</b>	<b>GEM Capabilities .....</b>	<b>5-26</b>
5-5-1	Communications State Model.....	5-27
5-5-2	Control State Model.....	5-31
5-5-3	Equipment Processing States.....	5-37
5-5-4	Event Notification.....	5-40
5-5-5	Error Messages .....	5-43
5-5-6	Documentation.....	5-44
5-5-7	Dynamic Event Report Configuration .....	5-45
5-5-8	Variable Data Collection .....	5-48
5-5-9	Trace Data Collection .....	5-49
5-5-10	Status Data Collection .....	5-51
5-5-11	Alarm Management .....	5-53
5-5-12	Host Commands.....	5-56
5-5-13	Enhanced Remote Commands.....	5-60

5-5-14	Equipment Constants.....	5-62
5-5-15	Process Program Management .....	5-66
5-5-16	Material Movement.....	5-87
5-5-17	Equipment Terminal Service .....	5-88
5-5-18	Clock .....	5-91
5-5-19	Limit Monitoring.....	5-93
5-5-20	Spooling .....	5-96
<b>5-6</b>	<b>Message Settings .....</b>	<b>5-102</b>
5-6-1	GEM Standard Messages.....	5-102
5-6-2	User-defined Messages .....	5-104

## Section 6 GEM Service Logs

<b>6-1</b>	<b>GEM Service Logs .....</b>	<b>6-2</b>
6-1-1	Types of GEM Service Logs.....	6-2
6-1-2	Saving Destinations for GEM Service Logs .....	6-2
6-1-3	Restrictions on GEM Service Logs .....	6-2
<b>6-2</b>	<b>Application Procedures for the GEM Service Logs .....</b>	<b>6-4</b>
6-2-1	Setting the Numbers of Records Saved in the GEM Service Logs .....	6-4
6-2-2	Displaying the Contents of the GEM Service Logs .....	6-4
<b>6-3</b>	<b>Log Viewer Operations.....</b>	<b>6-6</b>
6-3-1	Installation of GEM Setting Tools .....	6-6
6-3-2	Starting and Stopping the Log Viewer.....	6-6
6-3-3	Configuration of the Main Window .....	6-7
6-3-4	Procedure to Display a GEM Service Log.....	6-8
6-3-5	Displaying the SECS Message Log .....	6-12
6-3-6	Displaying the HSMS Communications Log .....	6-15
6-3-7	Displaying the Execution Log.....	6-17
6-3-8	Filters .....	6-18
6-3-9	Saving the Current Settings .....	6-18
6-3-10	Outputting Logs to Files .....	6-19
6-3-11	Windows.....	6-22
6-3-12	Help.....	6-22

## Section 7 Functionality Other Than the GEM Services

<b>7-1</b>	<b>SD Memory Cards.....</b>	<b>7-2</b>
7-1-1	Directory Structure of the SD Memory Card .....	7-2
7-1-2	Restrictions When No SD Memory Card Is Inserted.....	7-2
7-1-3	Operation When Data Cannot Be Saved in the SD Memory Card.....	7-2
7-1-4	Operation When the SD Memory Card Is Replaced .....	7-3
<b>7-2</b>	<b>Backup Functions .....</b>	<b>7-5</b>
7-2-1	Data That Is Backed Up.....	7-5
7-2-2	Data That Is Not Backed Up .....	7-5
7-2-3	Backup Functions for GEM Setting Data .....	7-5
7-2-4	Compatibility between CPU Unit Models .....	7-6
7-2-5	Compatibility between Versions of CPU Units .....	7-6
7-2-6	Restrictions for Backup Function Execution.....	7-7

## Section 8 SECS/GEM Configurator

<b>8-1</b>	<b>Installing and Uninstalling the GEM Setting Tools.....</b>	<b>8-3</b>
8-1-1	Installation Precautions.....	8-3
8-1-2	Applicable Operating Systems for the GEM Setting Tools .....	8-3
8-1-3	Installed Application Software .....	8-3
8-1-4	Installation Procedure for the GEM Setting Tools .....	8-4
8-1-5	Uninstallation Procedure for the GEM Setting Tools .....	8-7

<b>8-2</b>	<b>Starting and Exiting the SECS/GEM Configurator .....</b>	<b>8-8</b>
8-2-1	Starting the SECS/GEM Configurator.....	8-8
8-2-2	Exiting the SECS/GEM Configurator .....	8-9
<b>8-3</b>	<b>Configuration of the SECS/GEM Configurator .....</b>	<b>8-10</b>
8-3-1	Window Configuration.....	8-10
8-3-2	Menu Structure .....	8-11
8-3-3	Operating Buttons.....	8-14
<b>8-4</b>	<b>Menu Bar Functions .....</b>	<b>8-15</b>
8-4-1	File .....	8-15
8-4-2	Build.....	8-19
8-4-3	Controller .....	8-21
8-4-4	Tool .....	8-26
8-4-5	Documentation.....	8-30
8-4-6	Window .....	8-34
8-4-7	Help .....	8-35
<b>8-5</b>	<b>Toolbar Configuration .....</b>	<b>8-36</b>
<b>8-6</b>	<b>Basic Operations on the List Menus .....</b>	<b>8-37</b>
8-6-1	List Menu Dialog Boxes .....	8-37
8-6-2	Setting Dialog Boxes .....	8-38
8-6-3	Variable Dialog Boxes.....	8-40
<b>8-7</b>	<b>Configuration .....</b>	<b>8-42</b>
8-7-1	GEM Service Log.....	8-42
<b>8-8</b>	<b>HSMS Settings .....</b>	<b>8-43</b>
8-8-1	HSMS Condition .....	8-43
<b>8-9</b>	<b>Data Definition .....</b>	<b>8-45</b>
8-9-1	Item.....	8-45
8-9-2	Equipment Constant (EC).....	8-47
8-9-3	Status Variable (SV) .....	8-50
8-9-4	Discrete Variable (DV) .....	8-53
8-9-5	List Structure Definitions.....	8-56
<b>8-10</b>	<b>Model Settings .....</b>	<b>8-58</b>
8-10-1	Communications State Model.....	8-58
8-10-2	Control State Model.....	8-59
<b>8-11</b>	<b>GEM Capability Settings .....</b>	<b>8-60</b>
8-11-1	Event Notification.....	8-61
8-11-2	Alarm Management .....	8-69
8-11-3	Host Command.....	8-72
8-11-4	Enhanced Remote Command .....	8-76
8-11-5	Equipment Constants .....	8-80
8-11-6	Process Program Management.....	8-81
8-11-7	Equipment Terminal Service .....	8-90
8-11-8	Limit Monitoring .....	8-92
8-11-9	Spooling.....	8-93
<b>8-12</b>	<b>Message Settings .....</b>	<b>8-95</b>
8-12-1	GEM Standard Messages.....	8-95
8-12-2	User-defined Messages.....	8-96
<b>8-13</b>	<b>Confirm Settings.....</b>	<b>8-101</b>
8-13-1	Item List .....	8-101
8-13-2	Message List.....	8-102
8-13-3	Event List.....	8-102
8-13-4	Report List .....	8-103
8-13-5	Alarm List.....	8-103

## Section 9 Troubleshooting

<b>9-1</b>	<b>Operation for Errors and Error Confirmation Methods.....</b>	<b>9-2</b>
------------	---	------------

<b>9-2</b>	<b>Errors Related to SECS/GEM .....</b>	<b>9-3</b>
9-2-1	Error Table.....	9-3
9-2-2	Error Descriptions .....	9-5

## Appendices

---

<b>A-1</b>	<b>GEM Instructions .....</b>	<b>A-3</b>
A-1-1	Table of GEM Instructions.....	A-3
A-1-2	Common Variables in GEM Instructions .....	A-4
A-1-3	Common Precautions for Correct Use of GEM Instructions.....	A-4
A-1-4	Error Codes That Occur for GEM Instruction Execution .....	A-5
A-1-5	Global Variables Used in the Sample Programming for GEM Instructions .....	A-6
A-1-6	Specifications of Individual GEM Instructions .....	A-9
A-1-7	Events That Occur for GEM Instruction Execution.....	A-187
<b>A-2</b>	<b>System-defined Variables .....</b>	<b>A-211</b>
A-2-1	GEM Service Version .....	A-212
A-2-2	Equipment Information .....	A-212
A-2-3	GEM Service Status.....	A-212
A-2-4	SECS Communications.....	A-213
A-2-5	Interlocks.....	A-215
A-2-6	HSMS Communications .....	A-215
A-2-7	Communications State Model .....	A-218
A-2-8	Equipment Processing State .....	A-218
A-2-9	Control State Model .....	A-218
A-2-10	Remote Control .....	A-219
A-2-11	Equipment Constants.....	A-220
A-2-12	Process Program Management .....	A-220
A-2-13	Equipment Terminal Services.....	A-224
A-2-14	Error Messages.....	A-226
A-2-15	Clock .....	A-227
A-2-16	Spooling .....	A-227
A-2-17	User-defined Messages .....	A-228
<b>A-3</b>	<b>Correspondence between Formats and Data Types .....</b>	<b>A-230</b>
<b>A-4</b>	<b>Designing Tasks to Use the GEM Services .....</b>	<b>A-231</b>
A-4-1	GEM Service Startup Time.....	A-231
A-4-2	Communications Performance of GEM Instructions .....	A-232
A-4-3	Checking the Task Execution Time Ratio .....	A-234
<b>A-5</b>	<b>Basic Specifications, Performance Specifications, and Functional Specifications ...</b>	<b>A-235</b>
<b>A-6</b>	<b>Version Information .....</b>	<b>A-236</b>
A-6-1	Checking Versions .....	A-236
A-6-2	Relationship between Unit Version and GEM Service Version .....	A-236
A-6-3	Relationship between Unit Version and Sysmac Studio Version .....	A-237
A-6-4	Combinations of Versions That Require Attention and How to Deal with Them .....	A-237

## Index

---





# Terms and Conditions Agreement

## Warranty, Limitations of Liability

### Warranties

#### ● Exclusive Warranty

Omron's exclusive warranty is that the Products will be free from defects in materials and workmanship for a period of twelve months from the date of sale by Omron (or such other period expressed in writing by Omron). Omron disclaims all other warranties, express or implied.

#### ● Limitations

OMRON MAKES NO WARRANTY OR REPRESENTATION, EXPRESS OR IMPLIED, ABOUT NON-INFRINGEMENT, MERCHANTABILITY OR FITNESS FOR A PARTICULAR PURPOSE OF THE PRODUCTS. BUYER ACKNOWLEDGES THAT IT ALONE HAS DETERMINED THAT THE PRODUCTS WILL SUITABLY MEET THE REQUIREMENTS OF THEIR INTENDED USE.

Omron further disclaims all warranties and responsibility of any type for claims or expenses based on infringement by the Products or otherwise of any intellectual property right.

#### ● Buyer Remedy

Omron's sole obligation hereunder shall be, at Omron's election, to (i) replace (in the form originally shipped with Buyer responsible for labor charges for removal or replacement thereof) the non-complying Product, (ii) repair the non-complying Product, or (iii) repay or credit Buyer an amount equal to the purchase price of the non-complying Product; provided that in no event shall Omron be responsible for warranty, repair, indemnity or any other claims or expenses regarding the Products unless Omron's analysis confirms that the Products were properly handled, stored, installed and maintained and not subject to contamination, abuse, misuse or inappropriate modification. Return of any Products by Buyer must be approved in writing by Omron before shipment. Omron Companies shall not be liable for the suitability or unsuitability or the results from the use of Products in combination with any electrical or electronic components, circuits, system assemblies or any other materials or substances or environments. Any advice, recommendations or information given orally or in writing, are not to be construed as an amendment or addition to the above warranty.

See <http://www.omron.com/global/> or contact your Omron representative for published information.

### Limitation on Liability; Etc

OMRON COMPANIES SHALL NOT BE LIABLE FOR SPECIAL, INDIRECT, INCIDENTAL, OR CONSEQUENTIAL DAMAGES, LOSS OF PROFITS OR PRODUCTION OR COMMERCIAL LOSS IN ANY WAY CONNECTED WITH THE PRODUCTS, WHETHER SUCH CLAIM IS BASED IN CONTRACT, WARRANTY, NEGLIGENCE OR STRICT LIABILITY.

Further, in no event shall liability of Omron Companies exceed the individual price of the Product on which liability is asserted.

## Application Considerations

### Suitability of Use

---

Omron Companies shall not be responsible for conformity with any standards, codes or regulations which apply to the combination of the Product in the Buyer's application or use of the Product. At Buyer's request, Omron will provide applicable third party certification documents identifying ratings and limitations of use which apply to the Product. This information by itself is not sufficient for a complete determination of the suitability of the Product in combination with the end product, machine, system, or other application or use. Buyer shall be solely responsible for determining appropriateness of the particular Product with respect to Buyer's application, product or system. Buyer shall take application responsibility in all cases.

NEVER USE THE PRODUCT FOR AN APPLICATION INVOLVING SERIOUS RISK TO LIFE OR PROPERTY WITHOUT ENSURING THAT THE SYSTEM AS A WHOLE HAS BEEN DESIGNED TO ADDRESS THE RISKS, AND THAT THE OMRON PRODUCT(S) IS PROPERLY RATED AND INSTALLED FOR THE INTENDED USE WITHIN THE OVERALL EQUIPMENT OR SYSTEM.

### Programmable Products

---

Omron Companies shall not be responsible for the user's programming of a programmable Product, or any consequence thereof.

## Disclaimers

### Performance Data

---

Data presented in Omron Company websites, catalogs and other materials is provided as a guide for the user in determining suitability and does not constitute a warranty. It may represent the result of Omron's test conditions, and the user must correlate it to actual application requirements. Actual performance is subject to the Omron's Warranty and Limitations of Liability.

### Change in Specifications

---

Product specifications and accessories may be changed at any time based on improvements and other reasons. It is our practice to change part numbers when published ratings or features are changed, or when significant construction changes are made. However, some specifications of the Product may be changed without any notice. When in doubt, special part numbers may be assigned to fix or establish key specifications for your application. Please consult with your Omron's representative at any time to confirm actual specifications of purchased Product.

### Errors and Omissions

---

Information presented by Omron Companies has been checked and is believed to be accurate; however, no responsibility is assumed for clerical, typographical or proofreading errors or omissions.

## **Statement of security responsibilities for assumed use cases and against threats**

OMRON SHALL NOT BE RESPONSIBLE AND/OR LIABLE FOR ANY LOSS, DAMAGE, OR EXPENSES DIRECTLY OR INDIRECTLY RESULTING FROM THE INFECTION OF OMRON PRODUCTS, ANY SOFTWARE INSTALLED THEREON OR ANY COMPUTER EQUIPMENT, COMPUTER PROGRAMS, NETWORKS, DATABASES OR OTHER PROPRIETARY MATERIAL CONNECTED THERETO BY DISTRIBUTED DENIAL OF SERVICE ATTACK, COMPUTER VIRUSES, OTHER TECHNOLOGICALLY HARMFUL MATERIAL AND/OR UNAUTHORIZED ACCESS.

It shall be the users sole responsibility to determine and use adequate measures and checkpoints to satisfy the users particular requirements for (i) antivirus protection, (ii) data input and output, (iii) maintaining a means for reconstruction of lost data, (iv) preventing Omron Products and/or software installed thereon from being infected with computer viruses and (v) protecting Omron Products from unauthorized access.



# Safety Precautions

---

Refer to the following manuals for safety precautions.

- NJ-series CPU Unit Hardware User's Manual (Cat No. W500)

# Precautions for Safe Use

---

Refer to the following manuals for precautions for safe use.

- NJ-series CPU Unit Hardware User's Manual (Cat No. W500)

# Precautions for Correct Use

---

Refer to the following manuals for safety precautions.

- NJ-series CPU Unit Hardware User's Manual (Cat No. W500)

## Host Connection Function

---

- Normal communications with the host may not be possible if incorrect settings are made for the host connection function. Also, if you specify an incorrect host address, you may communicate with the wrong host.  
Make all settings carefully when you transfer the GEM setting data to the Controller.
- The host connection function will not operate if the variables assigned to the host connection function do not exist in the Controller. Also, the host connection function may not operate normally if the data types of the variables are not correct.  
Confirm that the variables assigned to the host connection function agree with the variables in the Controller before you transfer the GEM setting data to the controller.
- If you delete a variable used for the host connection function or change a variable name or data type, make the same change in the variable assigned in the host connection function.

## Testing Operation

---

- If you cannot connect to the host, check the value of the `_GEM_HSMSState` (HSMS Communications Status) system-defined variable. If the value of `_GEM_HSMSState` is FALSE, check the Ether-Net/IP settings and cable wiring to see if they are correct.
- If you operate the system while connected to the host, use the Host Simulator to sufficiently check functionality.

## Operation

---

- If there are network problems during operation, the host will be disconnected and message communications will not be performed. Do not replace network devices or disconnect the LAN cable during operation.
- If an SD Memory Card is not inserted, the GEM Service logs and spool data will not be recorded. Also, it will not be possible to upload or download the GEM setting data between the SECS/GEM Configurator and the CPU Unit.  
Inset an SD Memory Card to use the host connection function.
- Stop the GEM Services before you replace the SD Memory Card. Do not upload or download the GEM setting data between the SECS/GEM Configurator and the CPU Unit while you are replacing the SD Memory Card.
- Before you turn OFF the power supply to the Controller, execute the `GEM_Shutdown` instruction and save the GEM Service logs and spool data to the SD Memory Card.  
If you do not execute the `GEM_Shutdown` instruction before you turn OFF the power supply to the Controller, the GEM Service logs and spool data may be corrupted.
- To prevent losing data for unexpected power interruptions, we recommend that you implement countermeasures for power interruptions, such as installing an uninterruptible power supply.

## Unit Replacement

---

- The GEM Service logs and spool data in the SD Memory Card are not backed up. If you replace the CPU Unit, you cannot continue to use the previous GEM Service logs and spool data.



## SD Memory Card Replacement

---

- If the end of the life of the SD Memory Card is detected, a SD Memory Card Life Exceeded event occurs and the value of the SD Memory Card Life Warning Flag `_Card1Deteriorated` changes to TRUE. Save the data that is on the SD Memory Card and replace the SD Memory Card.
- If you replace the SD Memory Card, any existing GEM Service logs and spool data are deleted. If necessary, use the Log Viewer to back up the GEM Service logs to a computer.
- Do not replace the SD Memory Card when the value of the `_GEM_SpoolingState` (Spooling State) system-defined variable is SPOOL ACTIVE. If you do, the sppl data will be deleted.
- We recommend that you use a new SD Memory Card when you replace the SD Memory Card. If you replace the SD Memory Card with one that was previously used, format it to delete any old files.



### Version Information

---

Combination of the CPU Unit version and SD Memory Card determines whether the SD memory card life expiration detection function can be used or not. Refer to *Specifications of Supported SD Memory Cards, Folders, and Files* in the *NJ/NX-series CPU Unit Software User's Manual* (Cat. No. W501) for details.

---

# Regulations and Standards

---

Refer to the following manuals for regulations and standards.

- NJ-series CPU Unit Hardware User's Manual (Cat No. W500)

# Versions

Hardware and software versions are used to manage NJ-series Units. You can check versions on the ID information indications or with the Sysmac Studio.

## Types of Versions

There are two types of versions: the unit version and the GEM Service version. These versions are managed separately, so either version can be updated without updating the other version.

### ● Unit Version

The unit version applies to the hardware and software in the Unit. The unit version is updated each time there is a change in hardware or software specifications. Even when two Units have the same model number, they will have functional or capability differences if they have different unit versions.

### ● GEM Service Version

The GEM Service version gives the version of the GEM Services that are implemented in the SECS/GEM CPU Unit. The GEM Service version is updated when there are changes to the specifications for the GEM Services.

## Checking Versions

You can check versions on the ID information indications or with the Sysmac Studio.

### Checking Versions on ID Information Indications

The version is given on the ID information indication on the side of the product.

The ID information on the NJ-series NJ501-1340 CPU Unit is shown below.

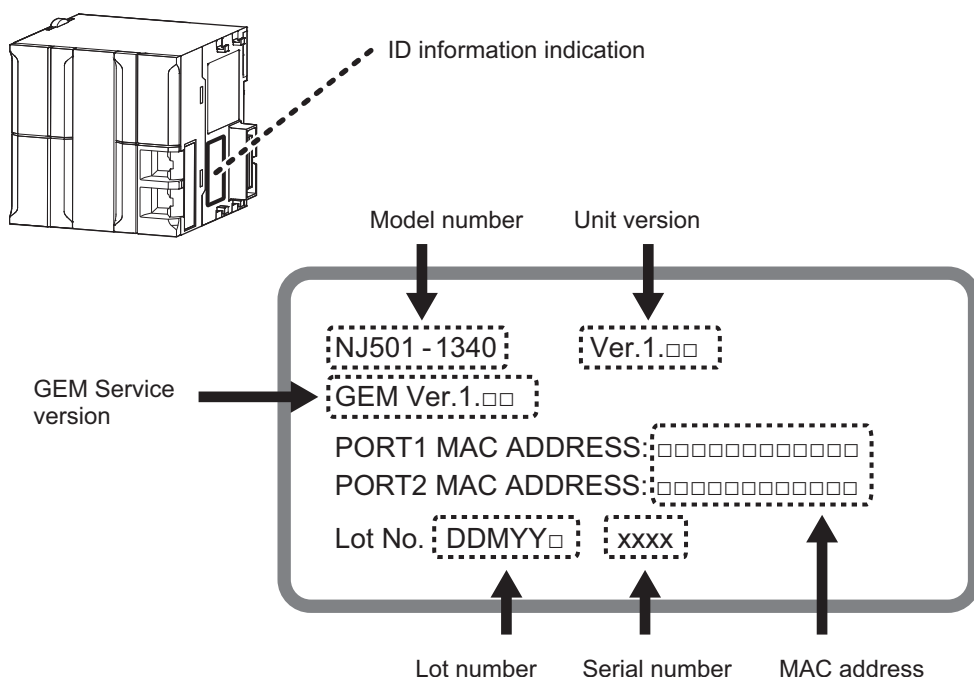

## Confirming Versions with the Sysmac Studio

You can use the Sysmac Studio to check versions.

### ● Checking the Unit Version of a Unit

You can use the Unit Production Information while the Sysmac Studio is online to check the unit version of a Unit. You can do this for the CPU Unit, CJ-series Special I/O Units, and CJ-series CPU Bus Units. You cannot check the unit versions of CJ-series Basic I/O Units with the Sysmac Studio.

Use the following procedure to check the unit version.

- 1 Double-click **CPU/Expansion Racks** under **Configurations and Setup** in the Multiview Explorer. Or, right-click **CPU/Expansion Racks** under **Configurations and Setup** and select Edit from the menu.

The Unit Editor is displayed.

- 2 Right-click any open space in the Unit Editor and select **Production Information**.

The Production Information Dialog Box is displayed.

- 3 Click the **Show Detail** or **Show Outline** Button at the lower right of the Production Information Dialog Box.

The view will change between the production information details and outline.

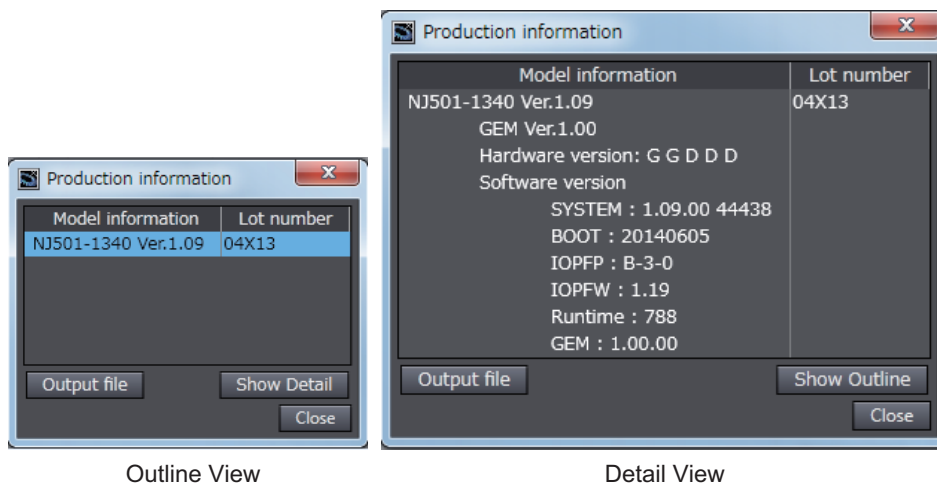

The information that is displayed is different for the Outline View and Detail View. The Detail View displays the unit version and GEM Service version. The Outline View displays only the unit version.

## Unit Versions of CPU Units and Sysmac Studio Versions

The functions that are supported depend on the unit version of the NJ-series CPU Unit. The version of Sysmac Studio that supports the functions that were added for an upgrade is also required to use those functions.

For functions that are shared with the NJ-series CPU Units, refer to the *NJ/NX-series CPU Unit Software User's Manual* (Cat. No. W501) for the relationship between the unit versions of the CPU Units and the Sysmac Studio versions, and for the functions that are supported by each unit version. Refer to *A-6-3 Relationship between Unit Version and Sysmac Studio Version* for the relationship between the unit versions of the SECS/GEM CPU Unit and the Sysmac Studio versions.

# Related Manuals

The followings are the manuals related to this manual. Use these manuals for reference.

Manual name	Cat. No.	Model numbers	Application	Description
NJ-series CPU Unit Hardware User's Manual	W500	NJ501-□□□□ NJ301-□□□□ NJ101-□□□□	Learning the basic specifications of the NJ-series CPU Units, including introductory information, designing, installation, and maintenance. Mainly hardware information is provided.	An introduction to the entire NJ-series system is provided along with the following information on the CPU Unit. <ul style="list-style-type: none"> <li>• Features and system configuration</li> <li>• Introduction</li> <li>• Part names and functions</li> <li>• General specifications</li> <li>• Installation and wiring</li> <li>• Maintenance and inspection</li> </ul>
NJ/NX-series CPU Unit Software User's Manual	W501	NX701-□□□□ NX102-□□□□ NX1P2-□□□□ NJ501-□□□□ NJ301-□□□□ NJ101-□□□□	Learning how to program and set up an NJ/NX-series CPU Unit. Mainly software information is provided.	The following information is provided on a Controller built with an NJ/NX-series CPU Unit. <ul style="list-style-type: none"> <li>• CPU Unit operation</li> <li>• CPU Unit features</li> <li>• Initial settings</li> <li>• Programming based on IEC 61131-3 language specifications</li> </ul>
NJ/NX-series Instructions Reference Manual	W502	NX701-□□□□ NX102-□□□□ NX1P2-□□□□ NJ501-□□□□ NJ301-□□□□ NJ101-□□□□	Learning detailed specifications on the basic instructions of an NJ/NX-series CPU Unit.	The instructions in the instruction set (IEC 61131-3 specifications) are described.
NJ/NX-series CPU Unit Motion Control User's Manual	W507	NX701-□□□□ NX102-□□□□ NX1P2-□□□□ NJ501-□□□□ NJ301-□□□□ NJ101-□□□□	Learning about motion control settings and programming concepts.	The settings and operation of the CPU Unit and programming concepts for motion control are described.
NJ/NX-series Motion Control Instructions Reference Manual	W508	NX701-□□□□ NX102-□□□□ NX1P2-□□□□ NJ501-□□□□ NJ301-□□□□ NJ101-□□□□	Learning about the specifications of the motion control instructions that are provided by OMRON.	The motion control instructions are described.
NJ/NX-series CPU Unit Built-in EtherCAT® Port User's Manual	W505	NX701-□□□□ NX102-□□□□ NX1P2-□□□□ NJ501-□□□□ NJ301-□□□□ NJ101-□□□□	Using the built-in EtherCAT port on an NJ/NX-series CPU Unit.	Information on the built-in EtherCAT port is provided. This manual provides an introduction and provides information on the configuration, features, and setup.
NJ/NX-series CPU Unit Built-in EtherNet/IP™ Port User's Manual	W506	NX701-□□□□ NX102-□□□□ NX1P2-□□□□ NJ501-□□□□ NJ301-□□□□ NJ101-□□□□	Using the built-in EtherNet/IP port on an NJ/NX-series CPU Unit.	Information on the built-in EtherNet/IP port is provided. Information is provided on the basic setup, tag data links, and other features.
NJ/NX-series Database Connection CPU Units User's Manual	W527	NX701-□□□20 NX102-□□□20 NJ501-□□□20 NJ101-□□□20	Using the database connection service with NJ/NX-series Controllers	Describes the database connection service.
NJ-series SECS Connection CPU Units User's Manual	W528	NJ501-1340	Using the GEM Services with NJ-series Controllers	Information is provided on the GEM Services.

Manual name	Cat. No.	Model numbers	Application	Description
NJ/NX-series Troubleshooting Manual	W503	NX701-□□□□ NX102-□□□□ NX1P2-□□□□ NJ501-□□□□ NJ301-□□□□ NJ101-□□□□	Learning about the errors that may be detected in an NJ/NX-series Controller.	Concepts on managing errors that may be detected in an NJ/NX-series Controller and information on individual errors are described.
Sysmac Studio Version 1 Operation Manual	W504	SYSMAC- SE2□□□	Learning about the operating procedures and functions of the Sysmac Studio.	Describes the operating procedures of the Sysmac Studio.

# Terminology

Term	Description
controller variable	A variable that is registered on the SECS/GEM Configurator and can be imported and exported between the SECS/GEM Configurator and the Sysmac Studio.
GEM	An acronym for Generic Equipment Model.
GEM capability	An operation that is executed by the equipment and specified in the GEM. All operations are executed using SECS-II message sequences and scenarios through the communications interface.
GEM instruction	An instruction that is related to the GEM Services. GEM instructions are used in the user program in the same way as other instructions.
GEM Service logs	Functionality to record the operation of the GEM Services. The following logs are recorded: a SECS message log, an HSMS communications log, and an execution log. All of the logs are recorded on an SD Memory Card.
GEM Services	Functionality based on SECS/GEM standard for host communications, GEM capability execution, communications logging, etc.
GEM setting data	Data required for the GEM Services to operate.
GEM Setting Tool	A generic name for Support Software for the SECS/GEM CPU Unit. The Log Viewer and SECS/GEM Configurator are included.
host	A computer that performs communications with SECS-compliant equipment, collects equipment data, and sends equipment commands.  A system consisting of ERP, MES, etc., in a semiconductor manufacturing system. The overall system consists of the host and manufacturing equipment.
host connection function	A function to connect to a host based on SECS/GEM standards.
HSMS	An acronym for High-speed SECS Message Services. This communications protocol uses Ethernet as the physical layer and TCP/IP as the transport layer.
link variable	A variable that is used to pass data between a host connection function item and the user program.
Log Viewer	A Support Software application that is used to view logs recorded in the SECS/GEM CPU Unit on a computer screen.
primary message	A SECS message with an odd-number function code. A primary message is sent at the beginning of a transaction.
secondary message	A SECS message with an even-number function code. A secondary message is sent in response to a primary message.
SECS	An acronym for Semiconductor Equipment Communications Standard. A communications standard that was created for communications between semiconductor manufacturing equipment and a host.
SECS-II	SEMI standard E5. The same as <i>SEMI Equipment Communications Standard 2 Message Content (SECS-II)</i> .  This standard defines the formats and meanings of the messages that are sent between the host and equipment. Messages are organized functionally by streams and assigned codes. Functions are assigned within each stream. The combination of the stream and function identifies a message.
SECS/GEM	An industry standard for communications between a host and manufacturing equipment in a semiconductor manufacturing system.
SECS/GEM Configurator	A Support Software application that is used to set GEM setting data and upload/download data to/from a SECS/GEM CPU Unit.

Term	Description
SEMI	An acronym for Semiconductor Equipment and Materials International. SEMI is an international trade association that provides manufacturing equipment, materials, and related services to the semiconductor, FPD, nanotechnology, MEMS, solar power, and other industries.
stream and function	Identifiers of the contents of messages between host and equipment defined by SECS-II.

Note This manual uses terminology defined in SEMI standards. Refer to the SEMI standards for details on the above terms and for information on terms that are not given above.



# Revision History

---

A manual revision code appears as a suffix to the catalog number on the front and back covers of the manual.

<b>Cat. No.</b>	<b>W528-E1-05</b>
-----------------	-------------------

↑  
Revision code

Revision code	Date	Revised content
01	September 2014	Original production
02	April 2016	<ul style="list-style-type: none"> <li>• Added information on the NX701-□□□□ and NJ101-□□□□.</li> <li>• Added version information.</li> <li>• Corrected mistakes.</li> </ul>
03	July 2021	<ul style="list-style-type: none"> <li>• Added information on the functions supported by unit version 1.25 of the NJ501-□□□□.</li> <li>• Added information of the SD Memory Card.</li> </ul>
04	April 2022	Added information to Terms and Conditions Agreement.
05	June 2022	Corrected mistakes.



# 1

## SECS/GEM CPU Unit Capabilities

A SECS/GEM CPU Unit is an NJ-series Standard CPU Unit that provides GEM Services. This section describes the capabilities that are provided by the GEM Services.

---

<b>1-1</b>	<b>SECS/GEM CPU Unit Features</b>	<b>1-2</b>
<b>1-2</b>	<b>Standard Compliance of the SECS/GEM CPU Unit</b>	<b>1-4</b>
1-2-1	SEMI Standard Compliance	1-4
1-2-2	SECS/GEM Standard Compliance	1-4
1-2-3	Supported SECS Messages	1-5

# 1-1 SECS/GEM CPU Unit Features

The SYSMAC NJ-series Controllers are next-generation machine automation controllers that provide the functionality and high-speed performance that are required for machine control. They provide the safety, reliability, and maintainability that are required of industrial controllers. The NJ-series Controllers provide the functionality of previous OMRON PLCs, and they also provide the functionality that is required for motion control. Synchronized control of I/O devices on high-speed EtherCAT can be applied to safety devices, vision systems, motion equipment, discrete I/O, and more.

OMRON offers the new Sysmac Series of control devices designed with unified communications specifications and user interface specifications. The NJ-series Machine Automation Controllers are part of the Sysmac Series. You can use them together with EtherCAT slaves, other Sysmac products, and the Sysmac Studio Automation Software to achieve optimum functionality and ease of operation. With a system that is created from Sysmac products, you can connect components and operate the system through unified concepts and usability.

In the same way as the NJ-series Standard CPU Units, the SECS/GEM CPU Unit supports the programming languages defined in IEC 61131-3. It also provides GEM Services that can implement streams and functions defined in the SEMI SECS/GEM standard.

## ● Processing Communications between Semiconductor Equipment Control Processes and a Host

The SECS/GEM CPU Unit provides both the functionality of an NJ-series Standard CPU Unit and functionality compliant with the SECS/GEM standard to enable processing communications between semiconductor equipment control processes and a host with just one Controller.

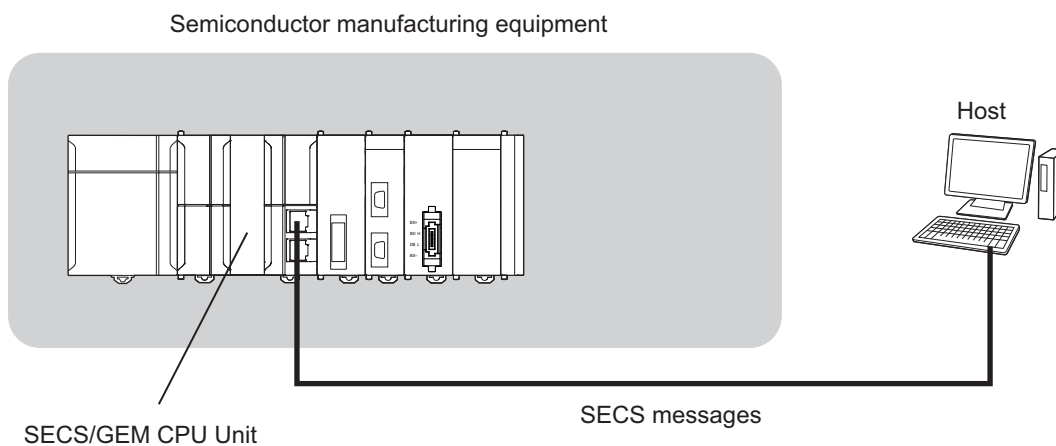

## ● Programming without Worrying about SECS Message Formats

A host connection function handles SECS messages between the host and equipment so you do not have to handle it directly in the user program. The host connection function is one of the GEM Services. It is located between the host and user program and transmits commands sent from the host to the user program and transmits commands from the user program to the host.

Therefore, the user does not need to interpret SECS messages sent from the host or prepare SECS message formats to send to the host.

For example, the following procedure is used to execute a host command using the remote command GEM capability.

- 1** The host sends Host Command Send (S2,F41).
- 2** The host connection function interprets the SECS message and informs the user program that a host command was received.
- 3** The user processes the host command.

- 4 When processing is completed, the user executes the Acknowledge Host Command (GEM\_AckHostCmd) GEM instruction.
- 5 The host connection function returns Host Command Acknowledge (S2,F42).

Commands from the user program to the host connection function are performed with special GEM instructions. Information between the user program and host connection function is passed using special variables called link variables.

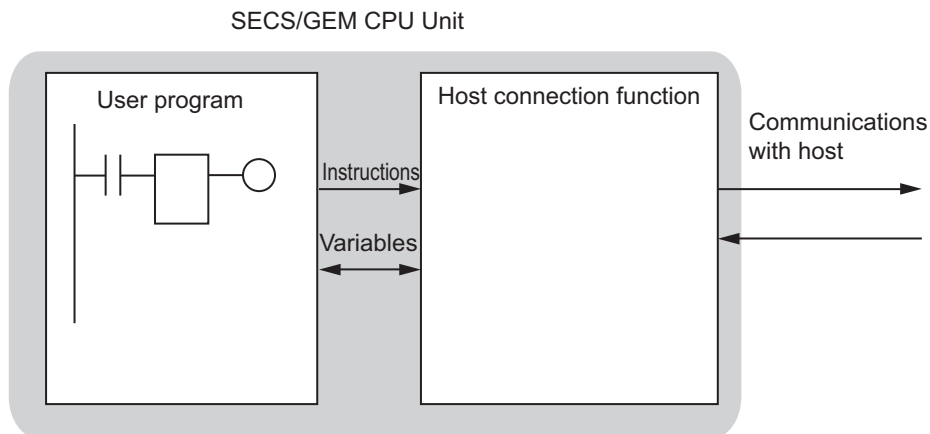

### ● User-defined Messages to Expand GEM Capabilities

In addition to the SECS messages defined in the SECS/GEM standard, the SECS/GEM CPU Unit supports user-defined messages that are uniquely set by the user. This allows you to flexibly implement functions for unique user semiconductor equipment.

### ● Setting GEM Setting Data with the SECS/GEM Configurator

To use a SECS/GEM CPU Unit, you use the standard Sysmac Studio Support Software for NJ-series Controllers, but you also use special Support Software called the SECS/GEM Configurator to make settings related to the GEM. You create the GEM setting data with the SECS/GEM Configurator and then transfer it to the SECS/GEM CPU Unit.

### ● Work Separation for Host Communications Design and Control Sequence Design

To execute an application with a SECS/GEM CPU Unit, you must design communications with the host and you must design the control sequences, including I/O controls. Both of these can be performed in parallel because settings for host communications are performed on the SECS/GEM Configurator and control sequence programming is performed on the Sysmac Studio.

### ● Complete Logging Functions

The SECS/GEM CPU Unit records three different logs on an SD Memory Card. You can check these logs from the Log Viewer or from the user program. Checking the logs simplifies troubleshooting when unintended operation occurs when building or operating the system.

- The SECS message log records the SECS messages sent between the host and equipment.
- The HSMS communications log records HSMS communications executed between the host and equipment.
- The execution log records GEM instruction execution in the user program and the writing of shared variables by the host connection function.

# 1-2 Standard Compliance of the SECS/GEM CPU Unit

The SECS/GEM CPU Unit complies with SEMI and SECS/GEM standards.

## 1-2-1 SEMI Standard Compliance

The SECS/GEM CPU Unit complies with the following SEMI standards.

Standard number	Standard name
E37-0303	High-speed SECS Message Services (HSMS) Generic Services
E37.1-0702	High-speed SECS Message Services Single-session Mode (HSMS-SS or HSMS-SSS)
E5-0707	SEMI Equipment Communications Standard 2 Message Content (SECS-II)
E30-0307	Generic Model for Communications and Control of Manufacturing Equipment (GEM)*1

\*1. E42 recipes, large process programs, and E139 recipes are not supported.

## 1-2-2 SECS/GEM Standard Compliance

The SECS/GEM CPU Unit complies with the following SECS/GEM standards.

GEM compliance		
Fundamental GEM requirement	Implemented	GEM compliant
State models	<input checked="" type="checkbox"/> Yes <input type="checkbox"/> No	<input checked="" type="checkbox"/> Yes <input type="checkbox"/> No
Equipment processing states	<input checked="" type="checkbox"/> Yes <input type="checkbox"/> No	
Host-initiated S1,F13/F14 scenario	<input checked="" type="checkbox"/> Yes <input type="checkbox"/> No	
Event notification	<input checked="" type="checkbox"/> Yes <input type="checkbox"/> No	
On-line identification	<input checked="" type="checkbox"/> Yes <input type="checkbox"/> No	
Error messages	<input checked="" type="checkbox"/> Yes <input type="checkbox"/> No	
Control (operator-initiated)	<input checked="" type="checkbox"/> Yes <input type="checkbox"/> No	
Documentation	<input checked="" type="checkbox"/> Yes <input type="checkbox"/> No	
Additional capabilities	Implemented	GEM compliant
Establish communications	<input checked="" type="checkbox"/> Yes <input type="checkbox"/> No	<input checked="" type="checkbox"/> Yes <input type="checkbox"/> No
Dynamic event report configuration	<input checked="" type="checkbox"/> Yes <input type="checkbox"/> No	<input checked="" type="checkbox"/> Yes <input type="checkbox"/> No
Variable data collection	<input checked="" type="checkbox"/> Yes <input type="checkbox"/> No	<input checked="" type="checkbox"/> Yes <input type="checkbox"/> No
Trace data collection	<input checked="" type="checkbox"/> Yes <input type="checkbox"/> No	<input checked="" type="checkbox"/> Yes <input type="checkbox"/> No
Status data collection	<input checked="" type="checkbox"/> Yes <input type="checkbox"/> No	<input checked="" type="checkbox"/> Yes <input type="checkbox"/> No
Alarm management	<input checked="" type="checkbox"/> Yes <input type="checkbox"/> No	<input checked="" type="checkbox"/> Yes <input type="checkbox"/> No
Remote control	<input checked="" type="checkbox"/> Yes <input type="checkbox"/> No	<input checked="" type="checkbox"/> Yes <input type="checkbox"/> No
Equipment constants	<input checked="" type="checkbox"/> Yes <input type="checkbox"/> No	<input checked="" type="checkbox"/> Yes <input type="checkbox"/> No
Process recipe management	<input checked="" type="checkbox"/> Yes <input type="checkbox"/> No	Process programs <input checked="" type="checkbox"/> Yes <input type="checkbox"/> No E42 recipes <input type="checkbox"/> Yes <input checked="" type="checkbox"/> No E139 recipes <input type="checkbox"/> Yes <input checked="" type="checkbox"/> No
Material movement	<input checked="" type="checkbox"/> Yes <input type="checkbox"/> No	<input checked="" type="checkbox"/> Yes <input type="checkbox"/> No
Equipment terminal services	<input checked="" type="checkbox"/> Yes <input type="checkbox"/> No	<input checked="" type="checkbox"/> Yes <input type="checkbox"/> No
Clock	<input checked="" type="checkbox"/> Yes <input type="checkbox"/> No	<input checked="" type="checkbox"/> Yes <input type="checkbox"/> No
Limits monitoring	<input checked="" type="checkbox"/> Yes <input type="checkbox"/> No	<input checked="" type="checkbox"/> Yes <input type="checkbox"/> No

GEM compliance		
Fundamental GEM requirement	Implemented	GEM compliant
Spooling	■ Yes □ No	■ Yes □ No
Control (host-initiated)	■ Yes □ No	■ Yes □ No

### 1-2-3 Supported SECS Messages

The SECS messages that are supported by the SECS/GEM CPU Unit are listed in the following table. In addition to these SECS messages, the use of user-defined messages is also supported.

Stream	Function	Communications direction H: Host E: Equipment	Function name
Sx	F0	H↔E	Abort Transaction
S1: Equipment Status	F1	H↔E	Are You There Request
	F2	H↔E	On Line Data
	F3	H→E	Selected Equipment Status Request
	F4	H←E	Selected Equipment Status Data
	F11	H→E	Status Variable Namelist Request
	F12	H←E	Status Variable Namelist Reply
	F13	H↔E	Establish Communications Request
	F14	H↔E	Establish Communications Request Acknowledge
	F15	H→E	Request OFF-LINE
	F16	H←E	OFF-LINE Acknowledge
F17	H→E	Request ON-LINE	
F18	H←E	ON-LINE Acknowledge	

Stream	Function	Communications direction H: Host E: Equipment	Function name
S2: Equipment Control and Diagnostics	F13	H→E	Equipment Constant Request
	F14	H←E	Equipment Constant Data
	F15	H→E	New Equipment Constant Send
	F16	H←E	New Equipment Constant Acknowledge
	F17	H↔E	Date and Time Request
	F18	H↔E	Date and Time Data
	F23	H→E	Trace Initialize Send
	F24	H←E	Trace Initialize Acknowledge
	F25	H→E	Loopback Diagnostic Request
	F26	H←E	Loopback Diagnostic Data
	F29	H→E	Equipment Constant Namelist Request
	F30	H←E	Equipment Constant Namelist
	F31	H→E	Date and Time Set Request
	F32	H←E	Date and Time Set Acknowledge
	F33	H→E	Define Report
	F34	H←E	Define Report Acknowledge
	F35	H→E	Link Event Report
	F36	H←E	Link Event Report Acknowledge
	F37	H→E	Enable/Disable Event Report
	F38	H←E	Enable/Disable Event Report Acknowledge
	F39	H→E	Multi-block Inquire
	F40	H←E	Multi-block Grant
	F41	H→E	Host Command Send
	F42	H←E	Host Command Acknowledge
	F43	H→E	Reset Spooling Streams and Functions
	F44	H←E	Reset Spooling Acknowledge
	F45	H→E	Define Variable Limit Attributes
	F46	H←E	Variable Limit Attribute Acknowledge
	F47	H→E	Variable Limit Attribute Request
	F48	H←E	Variable Limit Attributes Send
F49	H→E	Enhanced Remote Command	
F50	H←E	Enhanced Remote Command Acknowledge	
S5: Exception Handling	F1	H←E	Alarm Report Send
	F2	H→E	Alarm Report Acknowledge
	F3	H→E	Enable/Disable Alarm Send
	F4	H←E	Enable/Disable Alarm Acknowledge
	F5	H→E	List Alarms Request
	F6	H←E	List Alarms Data
	F7	H→E	List Enabled Alarm Request
	F8	H←E	List Enabled Alarm Data
S6: Data Collection	F1	H←E	Trace Data Send
	F2	H→E	Trace Data Acknowledge
	F11	H←E	Event Report Send
	F12	H→E	Event Report Acknowledge
	F15	H→E	Event Report Request
	F16	H←E	Event Report Data
	F19	H→E	Individual Report Request
	F20	H←E	Individual Report Data
	F23	H→E	Request Spooled Data
F24	H←E	Request Spooled Data Acknowledgement Send	



Stream	Function	Communica- tions direction H: Host E: Equipment	Function name
S7: Process Program Management	F1	H↔E	Process Program Load Inquire
	F2	H↔E	Process Program Load Grant
	F3	H↔E	Process Program Send
	F4	H↔E	Process Program Acknowledge
	F5	H↔E	Process Program Request
	F6	H↔E	Process Program Data
	F17	H→E	Delete Process Program Send
	F18	H←E	Delete Process Program Acknowledge
	F19	H→E	Current EPPD Request
	F20	H←E	Current EPPD Data
	F23	H↔E	Formatted Process Program Send
	F24	H↔E	Formatted Process Program Acknowledge
	F25	H↔E	Formatted Process Program Request
	F26	H↔E	Formatted Process Program Data
	F27	H←E	Process Program Verification Send
F28	H→E	Process Program Verification Acknowledge	
S9: System Errors	F1	H←E	Unrecognized Device ID
	F3	H←E	Unrecognized Stream Type
	F5	H←E	Unrecognized Function Type
	F7	H←E	Illegal Data
	F9	H←E	Transaction Timer Timeout
	F11	H←E	Data Too Long
	F13	H←E	Conversation Timeout
S10: Terminal Services	F1	H←E	Terminal Request
	F2	H→E	Terminal Request Acknowledge
	F3	H→E	Terminal Display, Single
	F4	H←E	Terminal Display, Single Acknowledge
	F5	H→E	Terminal Display, Multi-block
	F6	H←E	Terminal Display, Multi-block Acknowledge
	F7	H←E	Multi-block Not Allowed



# 2

## System Configuration and Functional Configuration

This section describes the system configuration of an NJ-series Controller in which a SECS/GEM CPU Unit is connected and the functional configuration of the SECS/GEM CPU Unit. It also introduces the GEM Services, which are the most characteristic functional configuration element of the SECS/GEM CPU Unit.

---

<b>2-1</b>	<b>System Configuration</b>	<b>2-2</b>
<b>2-2</b>	<b>Functional Configuration of SECS/GEM CPU Unit</b>	<b>2-5</b>
<b>2-3</b>	<b>Overview of GEM Service Operation</b>	<b>2-7</b>
2-3-1	SECS Messages When Host Sends the Primary Message	2-7
2-3-2	SECS Messages When Equipment Sends the Primary Message	2-11
2-3-3	Link Variables	2-14

## 2-1 System Configuration

The I/O ports of a SECS/GEM CPU Unit are the same as the I/O ports of an NJ-series Standard CPU Unit. Therefore, the connection methods for EtherCAT slaves and HMIs are the same as an NJ-series Controller in which a Standard CPU Unit is connected.

A typical system configuration for an NJ-series Controller in which a SECS/GEM CPU Unit is connected is shown below.

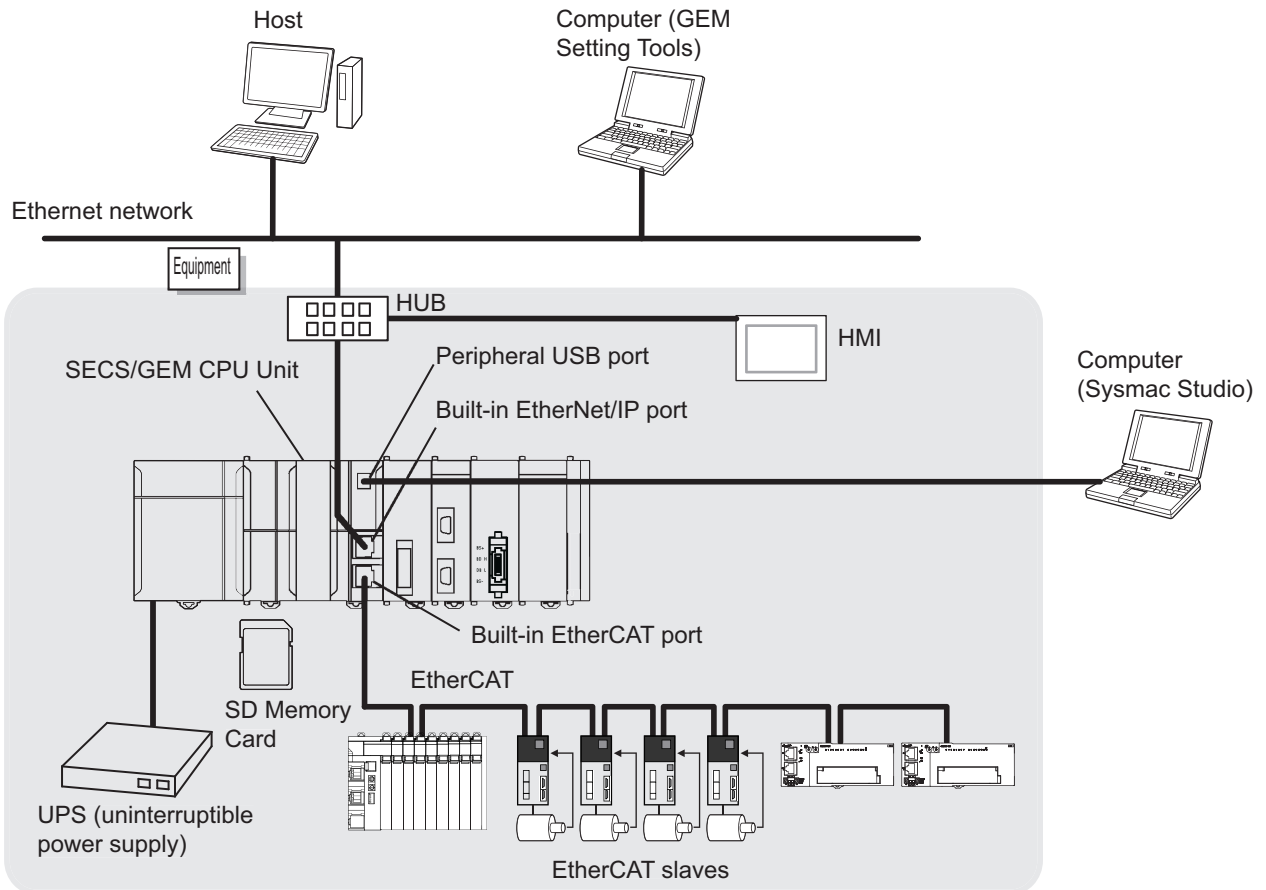

### ● Host

The host computer performs communications with the equipment, collects data from the equipment, and sends commands to the equipment.

### ● Equipment

The equipment manufacturers semiconductors, FPDs, etc. It performs communications with the host. The NJ-series Controller in which a SECS/GEM CPU Unit is connected is mounted in the equipment.

### ● SECS/GEM CPU Unit

The SECS/GEM CPU Unit is an NJ-series NJ501-1300 Standard CPU Unit to which GEM Services were added. The GEM Services provide functionality defined in the SECS/GEM standard. Therefore, the dimensions, power consumption, operating environment, I/O ports, functions, and other capabilities of the SECS/GEM CPU Unit are the same as the NJ501-1300 except for the specifications for the SECS/GEM standard. There is no NJ501-1300 functionality that is not supported by the NJ501-1340.

For NJ501-1300 specifications, refer to the *NJ-series CPU Unit Hardware User's Manual* (Cat. No. W500) and *NJ/NX-series CPU Unit Software User's Manual* (Cat. No. W501).

The unique specifications of the SECS/GEM CPU Unit are introduced below.

Item		Description
Model number		NJ501-1340
Versions		Both a unit version and a GEM Service version are managed.*1
GEM Services		Functionality based on SECS/GEM standard for host communications, GEM Service logging, etc.
SECS message communications	Applicable port	Built-in EtherNet/IP port
	Communications protocol	TCP/IP
	Applicable standards	HSMS-SS
	Number of connected hosts	1
	Maximum message length [Kbytes]	256*2

\*1. Refer to *Versions* on page 21 for the methods to check the versions.

\*2. The maximum length of a SECS message for process program management is 257 Kbytes.

### ● SD Memory Cards

The SECS/GEM CPU Unit supports the same SD Memory Cards as the NJ-series Standard CPU Units. The GEM Service logs and spool data used in the GEM Services are stored on an SD Memory Card. You can insert an SD Memory Card in the SECS/GEM CPU Unit.

### ● Built-in EtherNet/IP Port

The SECS/GEM CPU Unit has the same built-in EtherNet/IP port as on an NJ-series Standard CPU Unit. It is used to perform communications with the host. Host communications for the GEM Services operate as one TCP/IP function of the built-in EtherNet/IP. You can use the other functions of the built-in EtherNet/IP, such as tag data links, at the same time as the GEM Services.



#### Precautions for Correct Use

If you use the Network Configurator with the SECS/GEM CPU Unit, set the CPU Unit model on the Network Configurator to the NJ501-1300.

### ● Built-in EtherCAT Port

The SECS/GEM CPU Unit has the same built-in EtherCAT port as on an NJ-series Standard CPU Unit. It is not directly related to the GEM Services.

### ● GEM Setting Tools

“GEM Setting Tools” is a generic name that includes the SECS/GEM Configurator that you use to create the setting data for the GEM Services and the Log Viewer that you use to display the GEM Service logs. The GEM Setting Tool Support Software is independent of the Sysmac Studio Support Software. The computer in which the GEM Setting Tools are installed is connected to the built-in EtherNet/IP port on the SECS/GEM CPU Unit.

You can install the SECS/GEM Configurator and the Sysmac Studio on the same computer.

The basic specifications of the GEM Setting Tools are given in the following table.

Item	Specification
Name	SECS/GEM Configurator
Model number	WS02-GCTL1

Item	Specification
Connection port on SECS/GEM CPU Unit	Built-in EtherNet/IP port or peripheral USB port
Number of connected Units	1
Communications protocol	TCP/IP
Communications port	Always 9700.
Data transfer method	FTP

The SECS/GEM Configurator provides the following functionality.

- Creating, editing, and saving GEM setting data
- Uploading and downloading GEM setting data
- Importing and exporting controller variables
- Creating SML files



### Precautions for Correct Use

---

The contents of the GEM setting data that is uploaded with the SECS/GEM Configurator is the same as the contents of the GEM setting data that was previously downloaded with the SECS/GEM Configurator. Even if the settings in the downloaded GEM setting data were changed by the user program or host, the changes will not be reflected in the uploaded GEM setting data.

---

The Log Viewer provides the following functionality.

- Uploading GEM Service logs
- Displaying GEM Service logs
- Outputting GEM Service log files

### ● Sysmac Studio

You use the same Sysmac Studio Support Software with the SECS/GEM CPU Unit as you do with an NJ-series Standard CPU Unit. The computer in which the Sysmac Studio is installed is connected to the peripheral USB port or built-in EtherNet/IP port on the SECS/GEM CPU Unit.

The SECS/GEM CPU Unit is supported by Sysmac Studio version 1.10 or higher. The following functionality is enabled if you select the model number of the SECS/GEM CPU Unit (NJ501-1340) in Select Device Area of Project Properties Dialog Box.

- Using system-defined variables related to GEM
- Using GEM instructions
- Adding GEM setting data in the data to back up

### ● UPS

A UPS is an uninterruptible power supply. It provides power to the SECS/GEM CPU Unit during power interruptions until the power supply to the SECS/GEM CPU Unit can be turned OFF safely.

# 2-2 Functional Configuration of SECS/GEM CPU Unit

The functional configuration of the SECS/GEM CPU Unit is shown in the following figure.

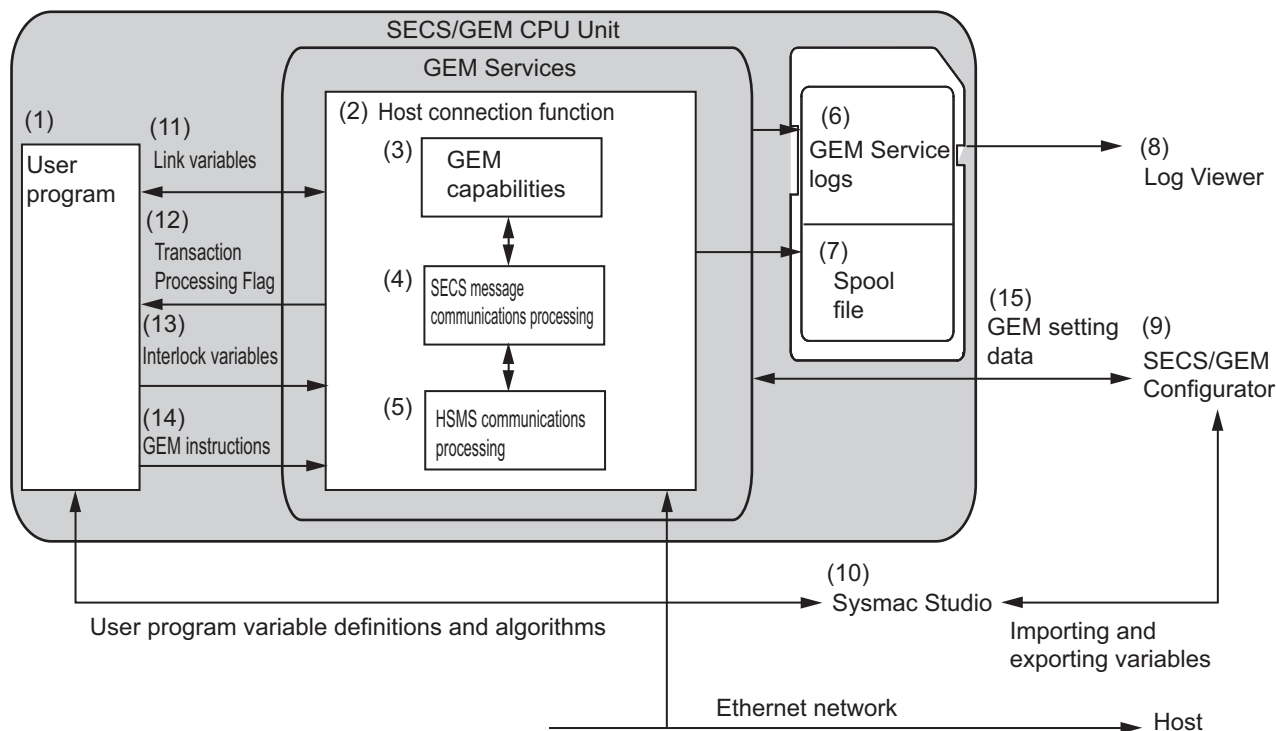

The elements in the above figure are described in the following table. Refer to the reference pages for detailed information on the elements.

No.	Element	Description	Reference
(1)	User program	The user program is the same as for an NJ-series Standard CPU Unit.	---
(2)	Host connection function	This software handles SECS messages with the host and exchanges data with the user program.	5-1 Basic Processing of the Host Connection Function on page 5-3
(3)	GEM capabilities	This software processes the GEM capabilities.	5-5 GEM Capabilities on page 5-26
(4)	SECS message communications processing	This software processes SECS message communications.	---
(5)	HSMS communications processing	This software processes HSMS communications.	5-2 HSMS Communications on page 5-14
(6)	GEM Service logs	This is a generic name for the HSMS communications log, SECS message log, and execution log.	Section 6 GEM Service Logs
(7)	Spool file	The spool file contains SECS messages that were queued for the GEM spooling capability while communications were not being performed between the host and equipment.	5-5-20 Spooling on page 5-96
(8)	Log Viewer	This Support Software displays the contents of the GEM Service logs.	6-3 Log Viewer Operations on page 6-6
(9)	SECS/GEM Configurator	This Support Software is used to set the GEM setting data.	Section 8 SECS/GEM Configurator

No.	Element	Description	Reference
(10)	Sysmac Studio	This Support Software is used to perform settings and programming for NJ-series CPU Units. You can import and export user program variable definitions to share them between the Sysmac Studio and the SECS/GEM Configurator.	---
(11)	Link variables	These variables are used to share information between the user program and host connection function.	<i>2-3-3 Link Variables</i> on page 2-14
(12)	Transaction processing flag	This variable is used by the host connection function to tell the user program that a SECS message was received from the host.	<i>5-1-3 Transaction Processing</i> on page 5-6
(13)	Interlock variables	These variables are used to prohibit execution of commands output to the host connection function from the host.	<i>5-1-4 Checking the Number of Buffered SECS Messages</i> on page 5-12
(14)	GEM instructions	These special instructions are used for the GEM Services.	<i>A-1 GEM Instructions</i> on page A-3
(15)	GEM setting data	This setting data is related to the GEM Services.	---



## 2-3 Overview of GEM Service Operation

The GEM Services perform SECS message communications with the host according to the SECS/GEM standard. There are the following two types of SECS messages exchanged between the host and equipment.

- SECS messages when host sends the primary message
- SECS messages when equipment sends the primary message

From the viewpoint of the processing performed by the equipment, there are the following two types of SECS messages.

- SECS messages processed by the GEM services alone
- SECS messages processed jointly by the GEM services and user program

If processing is performed jointly by the GEM Services and user program, the variables that are used to pass data between the GEM Services and the user program are called link variables.

### 2-3-1 SECS Messages When Host Sends the Primary Message

When the host sends the primary message, the GEM Services receive the message and interpret it. Some SECS messages are processed just by the GEM Services and some are processed jointly by the GEM Services and user program.

#### SECS Messages Processed by the GEM Services Alone

After the GEM Services receive the SECS message from the host, the message is processed automatically without notifying the user program. Therefore, you do not have to perform any processing in the user program.

#### SECS Messages Processed Jointly by the GEM Services and User Program

The processing performed by the GEM Services and user program is as follows:

- 1** The GEM Services receive the primary message from the host.
- 2** The GEM Services use the transaction processing flag to notify the user program that a SECS message was received.
- 3** The user program performs the required processing for the SECS message.
- 4** The user program uses a GEM instruction to notify the GEM Services that it performed the processing.
- 5** The GEM Services return a secondary message.

If an interlock variable is used to prohibit the execution of processing, the GEM Services do not notify the user program. The GEM Services automatically return a secondary message saying that the execution of processing is not permitted.

The primary SECS messages that the host can send are listed in the following table. The table also tells if processing is performed by the GEM Services alone or jointly by the GEM Services and user program, and the table gives any related transaction processing flag and interlock variables. If processing is performed jointly by the GEM Services and user program, the GEM instructions that are executed in the user program are given in the *Processing* column.

Stream	Function	Function name	Processing	Transaction processing flag	Interlock variable
S1: Equipment Status	F1	Are You There Request	GEM Services	---	---
	F2	On Line Data			
	F3	Selected Equipment Status Request	GEM Services	---	---
	F4	Selected Equipment Status Data			
	F11	Status Variable Namelist Request	GEM Services	---	---
	F12	Status Variable Namelist Reply			
	F13	Establish Communications Request	GEM Services	---	---
	F14	Establish Communications Request Acknowledge			
	F15	Request OFF-LINE	GEM Services	---	---
	F16	OFF-LINE Acknowledge			
	F17	Request ON-LINE	GEM Services	---	_GEM _Interlock _ControlState
	F18	ON-LINE Acknowledge			

Stream	Function	Function name	Processing	Transaction processing flag	Interlock variable
S2: Equipment Control and Diagnostics	F13	Equipment Constant Request	GEM Services	---	---
	F14	Equipment Constant Data			
	F15	New Equipment Constant Send	GEM Services	---	---
	F16	New Equipment Constant Acknowledge			
	F17	Date and Time Request	GEM Services	---	_GEM
	F18	Date and Time Data			_Interlock
	F23	Trace Initialize Send	GEM Services	---	---
	F24	Trace Initialize Acknowledge			
	F29	Equipment Constant Namelist Request	GEM Services	---	---
	F30	Equipment Constant Namelist			
	F31	Date and Time Set Request	GEM Services	---	---
	F32	Date and Time Set Acknowledge			
	F33	Define Report	GEM Services	---	---
	F34	Define Report Acknowledge			
	F35	Link Event Report	GEM Services	---	---
	F36	Link Event Report Acknowledge			
	F37	Enable/Disable Event Report	GEM Services	---	---
	F38	Enable/Disable Event Report Acknowledge			
	F39	Multi-block Inquire	GEM Services	---	---
	F40	Multi-block Grant			
	F41	Host Command Send	Jointly: GEM_AckHost- Cmd	_GEM_Busy HostCmd	_GEM
	F42	Host Command Acknowledge			_Interlock
	F43	Reset Spooling Streams and Functions	GEM Services	---	---
	F44	Reset Spooling Acknowledge			
	F45	Define Variable Limit Attributes	GEM Services	---	---
	F46	Variable Limit Attribute Acknowledge			
	F47	Variable Limit Attribute Request	GEM Services	---	---
	F48	Variable Limit Attributes Send			
	F49	Enhanced Remote Command	Jointly: GEM_AckEn- hancedCmd	_GEM_Busy EnhancedRmt Cmd	_GEM
	F50	Enhanced Remote Command Acknowledge			_Interlock_ EnhancedRmt Cmd

Stream	Function	Function name	Processing	Transaction processing flag	Interlock variable
S5: Exception Handling	F3	Enable/Disable Alarm Send	GEM Services	---	---
	F4	Enable/Disable Alarm Acknowledge			
	F5	List Alarms Request	GEM Services	---	---
	F6	List Alarms Data			
	F7	List Enabled Alarm Request	GEM Services	---	---
	F8	List Enabled Alarm Data			
S6: Data Collection	F15	Event Report Request	GEM Services	---	---
	F16	Event Report Data			
	F19	Individual Report Request	GEM Services	---	---
	F20	Individual Report Data			
	F23	Request Spooled Data	GEM Services	---	---
	F24	Request Spooled Data Acknowledgement Send			
S7: Process Program Management	F1	Process Program Load Inquire	GEM Services	---	_GEM _Interlock_PP
	F2	Process Program Load Grant			
	F3	Process Program Send	Jointly: GEM_AckP- PDownload	_GEM_Busy HostPPDownload	_GEM _Interlock_PP
	F4	Process Program Acknowledge			
	F5	Process Program Request	Jointly: GEM_Re- spPPUpload	_GEM_Busy HostPPUpload	_GEM _Interlock_PP
	F6	Process Program Data			
	F17	Delete Process Program Send	Jointly: GEM_AckP- PDelete	_GEM_Busy HostPPDelete	_GEM _Interlock_PP
	F18	Delete Process Program Acknowledge			
	F19	Current EPPD Request	GEM Services	---	---
	F20	Current EPPD Data			
	F23	Formatted Process Program Send	Jointly: GEM_AckFor- mattedP- PDownload	_GEM_Busy HostFormatted PPDownload	_GEM _Interlock_PP
	F24	Formatted Process Program Acknowledge			
	F25	Formatted Process Program Request	Jointly: GEM_RespFor- mattedPPUp- load	_GEM_Busy HostFormatted PPUpload	_GEM _Interlock_PP
	F26	Formatted Process Program Data			
S9: System Errors	F1	Unrecognized Device ID	GEM Services	---	---
	F3	Unrecognized Stream Type	GEM Services	---	---
	F5	Unrecognized Function Type	GEM Services	---	---
	F7	Illegal Data	GEM Services	---	---
	F9	Transaction Timer Timeout	GEM Services	---	---
	F11	Data Too Long	GEM Services	---	---
	F13	Conversation Timeout	GEM Services	---	---

Stream	Function	Function name	Processing	Transaction processing flag	Interlock variable
S10: Terminal Services	F3	Terminal Display, Single	Jointly: GEM_AckTerminalMsgSB	_GEM_Busy HostTerminalMsgSB	---
	F4	Terminal Display, Single Acknowledge			
	F5	Terminal Display, Multi-block	Jointly: GEM_AckTerminalMsgMB	_GEM_Busy HostTerminalMsgMB	---
	F6	Terminal Display, Multi-block Acknowledge			
	F7	Multi-block Not Allowed	GEM Services	---	---

**2-3-2 SECS Messages When Equipment Sends the Primary Message**

When the equipment sends the primary message, the host returns a secondary message. For the secondary SECS message from the host, some messages are processed just by the GEM Services and some are processed jointly by the GEM Services and user program.

**SECS Messages Processed by the GEM Services Alone**

After the GEM Services receive the secondary message from the host, the message is processed automatically without notifying the user program. Therefore, you do not have to perform any processing in the user program.

**SECS Messages Processed Jointly by the GEM Services and User Program**

The processing performed by the GEM Services and user program is as follows:

- 1** The user program executes a GEM instruction to tell the GEM Services to send a primary message to the host.
- 2** The GEM Services send a primary message.
- 3** The GEM Services receive the secondary message from the host.
- 4** The GEM Services use the Transaction Processing Flag to notify the user program that a secondary message was received.
- 5** The user program checks the values of the Transaction Processing Result Variables.
- 6** The user program performs the required processing according to the values of the Transaction Processing Result Variables.

The primary SECS messages that the equipment can send are listed in the following table. The table also tells if processing of the secondary message from the host is performed by the GEM Services alone or jointly by the GEM Services and user program, and the table gives the GEM instructions executed by the user program along with any related transaction processing flags and transaction processing result variables.

Stream	Function	Function name	Processing	GEM instruction	Transaction processing flag	Transaction processing result variable
S1: Equipment Status	F1	Are You There Request	GEM Services	GEM_ChangeControlState	---	---
	F2	On Line Data				
	F13	Establish Communications Request	GEM Services	GEM_ChangeCommState	---	---
	F14	Establish Communications Request Acknowledge				
S2: Equipment Control and Diagnostics	F17	Date and Time Request	Jointly	GEM_RequestChangeTime	_GEM_BusyEquipChangeTime	_GEM_EquipChangeTimeRslt
	F18	Date and Time Data				
S5: Exception Handling	F1	Alarm Report Send	GEM Services	GEM_ReportAlarm	---	---
	F2	Alarm Report Acknowledge				
S6: Data Collection	F1	Trace Data Send	GEM Services	---*1	---	---
	F2	Trace Data Acknowledge				
	F11	Event Report Send	GEM Services	GEM_ReportEvent*2	---	---
	F12	Event Report Acknowledge				
S7: Process Program Management	F1	Process Program Load Inquire	GEM Services	GEM_UploadPP, GEM_UploadFormattedPP	---	---
	F2	Process Program Load Grant				
	F3	Process Program Send	Jointly	GEM_UploadPP	_GEM_BusyEquipPPUpload	_GEM_EquipPPUploadRslt
	F4	Process Program Acknowledge				
	F5	Process Program Request	Jointly	GEM_RequestPPDownload	_GEM_BusyEquipPPDownload	_GEM_EquipPPDownloadRslt
	F6	Process Program Data				
	F23	Formatted Process Program Send	Jointly	GEM_UploadFormattedPP	_GEM_BusyEquipFormattedPPUpload	_GEM_EquipFormattedPPUploadRslt
	F24	Formatted Process Program Acknowledge				
	F25	Formatted Process Program Request	Jointly	GEM_RequestFormattedPPDownload	_GEM_BusyEquipFormattedPPDownload	_GEM_EquipFormattedPPDownloadRslt
	F26	Formatted Process Program Data				

Stream	Function	Function name	Pro- cessing	GEM instruc- tion	Transaction processing flag	Transaction processing result variable
S9: Sys- tem Errors	F1	Unrecognized Device ID	GEM Services	---*3	---	---
	F3	Unrecognized Stream Type	GEM Services	---*3	---	---
	F5	Unrecognized Function Type	GEM Services	---*3	---	---
	F7	Illegal Data	GEM Services	---*3	---	---
	F9	Transaction Timer Timeout	GEM Services	---*3	---	---
	F11	Data Too Long	GEM Services	---*3	---	---
	F13	Conversation Timeout	GEM Services	---*3	---	---
S10: Ter- minal Ser- vices	F1	Terminal Request	Jointly	GEM_Send TerminalMsg	_GEM_Busy EquipTerminal Msg	_GEM_Equip TerminalMsg Rslt
	F2	Terminal Request Acknowledge				
	F7	Multi-block Not Allowed	GEM Services	---*4	---	---

- \*1. After Trace Initialize Send (S2,F23) is received from the host, the GEM Services automatically send Trace Data Send (S6,F1). It is not necessary for the user program to execute a GEM instruction.
- \*2. The GEM\_ChangeControlState instruction or GEM\_ReportAlarm instruction is sometimes executed instead of the GEM\_ReportEvent instruction. The GEM Services sometimes automatically send Event Report Send (S6,F11) depending on the GEM capability.
- \*3. The GEM Services automatically send a SECS message for an illegal primary message from the host. It is not necessary for the user program to execute a GEM instruction.
- \*4. If processing is not permitted for Terminal Display, Multi-block (S10,F5) from the host, the GEM Services automatically send a SECS message. It is not necessary for the user program to execute a GEM instruction.

### 2-3-3 Link Variables

Link variables are used to pass data between the GEM Services and the user program. Link variables include system-defined variables and user-defined variables. User-defined link variables are set on the SECS/GEM Configurator and then transferred to the CPU Unit.

The link variables and their applicable streams, functions, and items are given in the following table.

#### Link Variables for Equipment Constants

The link variables for equipment constants are given in the following table along with the equipment constant names (ECNAMES).

Applicable streams and functions	Link variable	Applicable item	Equipment constant name (ECNAME)	Data type	RW *1	Retain *2
S2F14, S2F15, and S6F11	_GEM_Establish Communications Timeout	EC	Establish Communications Timeout	A-2 System-defined Variables on page A-211		
	_GEM_SpoolParam.EnableSpooling	EC	EnableSpooling			
	_GEM_SpoolParam.MaxSpoolTransmit	EC	MaxSpoolTransmit			
	_GEM_SpoolParam.OverWriteSpool	EC	OverWriteSpool			
	_GEM_TimeFormat	EC	TimeFormat			
	Equipment constants (ECs)	EC	Any	BYTE, BOOL, STRING, SINT, INT, DINT, USINT, UINT, UDINT, REAL, or LREAL	R	Retained

\*1. Gives the R/W attribute of the variable. R: Read only, RW: Read/write.

\*2. Gives the Retain attribute of the variable. Either "Retained" or "Not retained" is given.



## Link Variables for Status Variables

The link variables for status variables are given in the following table along with the status variable names (SVNAMEs).

Applicable streams and functions	Link variable	Applicable item	Status variable name (SVNAME)	Data type	RW *1	Retain *2
S1F4, S6F1, and S6F11	_GEM_ControlState	SV	ControlState	A-2 System-defined Variables on page A-211		
	_GEM_PPExecName	SV	PPExecName			
	_GEM_PPFormat	SV	PPFormat			
	_GEM_ProcessState	SV	ProcessState			
	_GEM_PreviousProcessState	SV	PreviousProcessState			
	_GEM_SpoolCondition.SpoolCountActual	SV	SpoolCountActual			
	_GEM_SpoolCondition.SpoolCountTotal	SV	SpoolCountTotal			
	_GEM_SpoolCondition.SpoolFullTime	SV	SpoolFullTime			
	_GEM_SpoolCondition.SpoolStartTime	SV	SpoolStartTime			
	Status variables (SVs)	SV	Any	BYTE, BOOL, STRING, SINT, INT, DINT, USINT, UINT, UDINT, REAL, or LREAL	R/W	Not retained.

\*1. Gives the R/W attribute of the variable. R: Read only, RW: Read/write.

\*2. Gives the Retain attribute of the variable. Either "Retained" or "Not retained" is given.

## Link Variables for Discrete Variables

The link variables for discrete variables are given in the following table along with the data value names (DVNAMEs).

Applicable streams and functions	Link variable	Applicable item	Data value name (DVNAME)	Data type	RW *1	Retain *2
S6F11	_GEM_OperatorCommnd	DV	OperatorCommnd	A-2 System-defined Variables on page A-211		
	_GEM_PPChange-Info.PPChangeName	DV	PPChangeName			
	_GEM_PPChange-Info.PPChangeStatus	DV	PPChangeStatus			
		Discrete variables (DVs)	DV			

\*1. Gives the R/W attribute of the variable. R: Read only, RW: Read/write.

\*2. Gives the Retain attribute of the variable. Either "Retained" or "Not retained" is given.

## Other Link Variables

The following table lists link variables other than those for equipment constants, status variables, and discrete variables.

Applicable streams and functions	Link variable	Applicable item	Data type	RW *1	Retain *2
S1F2, S1F13, and S1F14	_GEM_EquipInfo.MDLN	MDLN	A-2 System-defined Variables on page A-211		
	_GEM_EquipInfo.SOFT-REV	SOFTREV			
S2F41	S2F41: RCMD	RCMD	STRING	R/W	Not retained.
	S2F41: CPNAME Count	Received CPNAME count	UINT	R/W	Not retained.
	S2F41: CPNAME Table	CPNAME	STRING array	R/W	Not retained.
	S2F41: CPVAL	CPVAL	BYTE, BOOL, STRING, SINT, INT, DINT, USINT, UINT, or UDINT	R/W	Not retained.
S2F42	S2F42: Error CPNAME Table	CPNAME	STRING array	R/W	Not retained.
	S2F42: CPACK Table	CPACK	BYTE array	R/W	Not retained.
S2F49	S2F49: OBJSPEC	OBJSPEC	STRING	R/W	Not retained.
	S2F49: RCMD	RCMD	STRING	R/W	Not retained.
	S2F49: CPNAME Count	Received CPNAME count	UINT	R/W	Not retained.
	S2F49: CPNAME Table	CPNAME	STRING array	R/W	Not retained.
	S2F49: CEPVAL	CEPVAL	BYTE, BOOL, STRING, SINT, INT, DINT, USINT, UINT, or UDINT	R/W	Not retained.
S2F50	S2F50: Error CPNAME Table	CPNAME	STRING array	R/W	Not retained.
	S2F50: CEPACK Table	CEPACK	USINT array	R/W	Not retained.
S7F3	Host-initiated Download, PPID	PPID	STRING	R/W	Not retained.
	Host-initiated Download, LENGTH	PPBODY size	UINT	R/W	Not retained.
	Host-initiated Download, PPBODY	PPBODY	BYTE, STRING, SINT, INT, DINT, USINT, UINT, or UDINT array	R/W	Not retained.
	Equipment-initiated Upload, PPBODY	PPBODY	BYTE, STRING, SINT, INT, DINT, USINT, UINT, or UDINT array	R/W	Not retained.
S7F4	_GEM_EquipPPUploadRslt.RsltCode	ACKC7*3	A-2 System-defined Variables on page A-211		
S7F5	Host-initiated Upload, PPID of Upload Request	PPID	STRING	R/W	Not retained.

Applicable streams and functions	Link variable	Applicable item	Data type	RW *1	Retain *2
S7F6	Equipment-initiated Download, PPID	PPID	STRING	R/W	Not retained.
	Equipment-initiated Download, LENGTH	PPBODY size	UINT	R/W	Not retained.
	Equipment-initiated Download, PPBODY	PPBODY	BYTE, STRING, SINT, INT, DINT, USINT, UINT, or UDINT array	R/W	Not retained.
	Host-initiated Upload, PPBODY	PPBODY	BYTE, STRING, SINT, INT, DINT, USINT, UINT, or UDINT array	R/W	Not retained.
S7F17	Deletion Requested PPID List, PPID Count	PPID element count	UINT	R/W	Not retained.
	Deletion Requested PPID List, PPID Table	PPID	STRING array	R/W	Not retained.
S7F20	PPID Management Table	PPID	STRING array	R/W	Retain
S7F23	Equipment-initiated Formatted Upload, CCODE Table	CCODE table	STRING, INT, DINT, UINT, or UDINT array	R/W	Not retained.
	Equipment-initiated Formatted Upload, PPARAM Table	PPARM table	BOOL, STRING, SINT, INT, DINT, USINT, UINT, UDINT, REAL, or LREAL array	R/W	Not retained.
	Equipment-initiated Formatted Upload, PPARAM Count	Number of PPARAMs sent	UINT	R/W	Not retained.
	Host-initiated Formatted Download, PPID	PPID	STRING	R/W	Not retained.
	Host-initiated Formatted Download, MDLN	MDLN	STRING	R/W	Not retained.
	Host-initiated Formatted Download, SOFTREV	SOFTREV	STRING	R/W	Not retained.
	Host-initiated Formatted Download, CCODE Count	Received CCODE count	UINT	R/W	Not retained.
	Host-initiated Formatted Download, CCODE Table	CCODE table	STRING, INT, DINT, UINT, or UDINT array	R/W	Not retained.
	Host-initiated Formatted Download, PPARAM Table	PPARM table	BOOL, STRING, SINT, INT, DINT, USINT, UINT, UDINT, REAL, or LREAL array	R/W	Not retained.
	Host-initiated Formatted Download, PPARAM Count	Number of PPARAMs sent	UINT	R/W	Not retained.
S7F24	_GEM_EquipFormatted PPUUploadRslt.Rslt	ACKC7*1	A-2 System-defined Variables on page A-211		
S7F25	Host-initiated Formatted Upload, PPID of Upload Request	PPID	BOOL, STRING, SINT, INT, DINT, USINT, UINT, UDINT, REAL, or LREAL array	R/W	Not retained.

Applicable streams and functions	Link variable	Applicable item	Data type	RW *1	Retain *2
S7F26	Host-initiated Formatted Upload, CCODE Table	CCODE table	STRING, INT, DINT, UINT, or UDINT array	R/W	Not retained.
	Host-initiated Formatted Upload, PPARAM Table	PPARM table	BOOL, STRING, SINT, INT, DINT, USINT, UINT, UDINT, REAL, or LREAL array	R/W	Not retained.
	Host-initiated Formatted Upload, PPARAM Count	Number of PPARAMs sent	UINT	R/W	Not retained.
	Equipment-initiated Formatted Download, PPID	PPID	STRING	R/W	Not retained.
	Equipment-initiated Formatted Download, MDLN	MDLN	STRING	R/W	Not retained.
	Equipment-initiated Formatted Download, SOFTREV	SOFTREV	STRING	R/W	Not retained.
	Equipment-initiated Formatted Download, CCODE Count	Received CCODE count	UINT	R/W	Not retained.
	Equipment-initiated Formatted Download, CCODE Table	CCODE table	STRING, INT, DINT, UINT, or UDINT array	R/W	Not retained.
	Equipment-initiated Formatted Download, PPARAM Table	PPARM table	BOOL, STRING, SINT, INT, DINT, USINT, UINT, UDINT, REAL, or LREAL array	R/W	Not retained.
	Equipment-initiated Formatted Download, PPARAM Count	Number of PPARAMs sent	UINT	R/W	Not retained.
S7F27	Verification Result, ACKC7A Table	ACKC7A	BYTE	R/W	Not retained.
	Verification Result, SEQNUM Table	SEQNUM	UINT	R/W	Not retained.
	Verification Result, ERRW7 Table	ERRW7	STRING	R/W	Not retained.
S10F2	_GEM_EquipTerminalMsgRslt.RsltCode	ACKC10	A-2 System-defined Variables on page A-211		
S10F3	Displayed TEXT of single-block terminal messages – Displayed TEXT	TEXT	STRING	R/W	Not retained.
	_GEM_HostTerminalMsgSB_TID	TID	A-2 System-defined Variables on page A-211		
S10F5	Displayed TEXT of multi-block terminal messages – Displayed TEXT Count	Received TEXT count	UINT	R/W	Not retained.
	Displayed TEXT of multi-block terminal messages – Displayed TEXT Table	TEXT	STRING array	R/W	Not retained.
	_GEM_HostTerminalMsgMB_TID	TID	A-2 System-defined Variables on page A-211		

Applicable streams and functions	Link variable	Applicable item	Data type	RW <sup>*1</sup>	Retain <sup>*2</sup>
SxFy	User-defined message send/receive parameter values	Link variable assigned to user-defined message item	---	R/W	Not retained.
	_GEM_HostUserMsgNo	Received message number for host-initiated user-defined message	A-2 System-defined Variables on page A-211		
SxFy+1	User-defined message send/receive parameter values	Link variable assigned to user-defined message item	---	R/W	Not retained.
	_GEM_EquipUserMsgNo	Received message number for equipment-initiated user-defined message	A-2 System-defined Variables on page A-211		

\*1. Gives the R/W attribute of the variable. R: Read only, RW: Read/write.

\*2. Gives the Retain attribute of the variable. Either "Retained" or "Not retained" is given.

\*3. S2F2 PPGNT is included.



# 3

## GEM Service Design Procedure

To use the SECS/GEM CPU Unit, you must design the system to use the GEM Services. This section describes the procedure to design a system to use the GEM Services.

---

<b>3-1</b>	<b>Overview of GEM Service Design Procedure</b>	<b>3-2</b>
<b>3-2</b>	<b>Using the SECS/GEM Configurator to Create the GEM Setting Data</b>	<b>3-4</b>
<b>3-3</b>	<b>Using the Sysmac Studio to Create the SECS/GEM Operation Programming</b>	<b>3-6</b>
3-3-1	Starting the Sysmac Studio and Creating a Project	3-6
3-3-2	FTP Settings	3-7
3-3-3	Creating the SECS/GEM Operation Programming	3-7
3-3-4	Restrictions When Defining Link Variables for User-defined Variables	3-8
<b>3-4</b>	<b>Debugging</b>	<b>3-9</b>

## 3-1 Overview of GEM Service Design Procedure

The following diagram shows how to design a system to use the GEM Services.

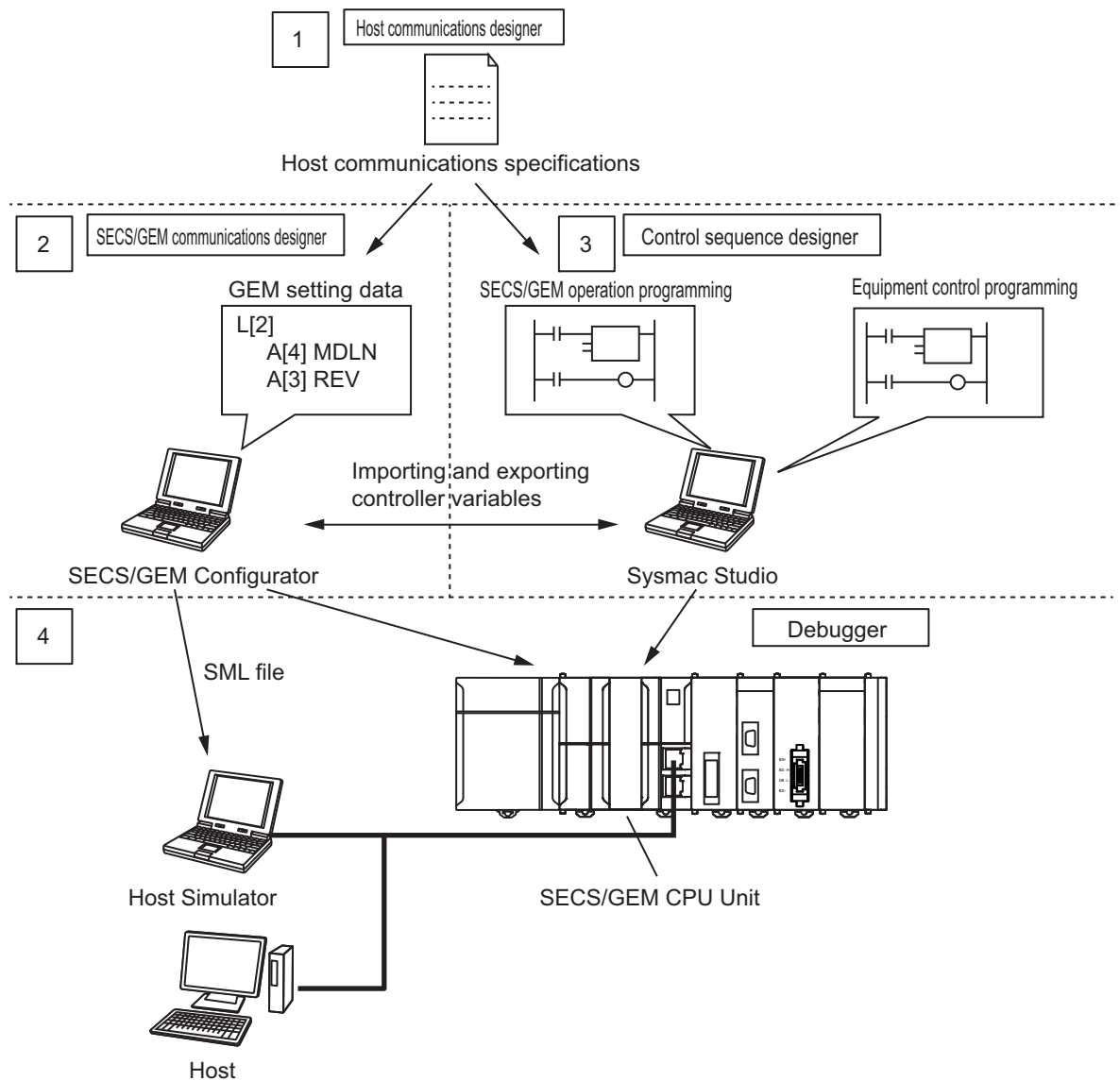

### 1 Creating the Host Communications Specifications

The host communications designer creates the host communications specifications.

### 2 Creating the GEM Setting Data

Based on the host communications specifications, the SECS/GEM communications designer uses the SECS/GEM Configurator to create the GEM setting data.

### 3 Creating the SECS/GEM Operation Programming

Based on the host communications specifications, the control sequence designer uses the Sysmac Studio to create the SECS/GEM operation programming.

### 4 Debugging

The debugger uses the host or a Host Simulator to debug the GEM setting data and SECS/GEM operation programming.



- **SECS/GEM Operation Programming**

The SECS/GEM operation programming is the programming in the user program to perform SECS message communications with the host jointly with the GEM Services. Some SECS messages are processed automatically by the GEM Services and therefore do not require the user program and some SECS messages must be processed jointly by the GEM Services and the user program. Refer to *2-3 Overview of GEM Service Operation* on page 2-7 for details on SECS messages that must be processed jointly by the GEM Services and the user program.

- **Equipment Control Programming**

Equipment control programming is the programming to control the equipment in the user program. The control sequence designer designs the equipment control programming. The procedures and methods for control programming, task design, and wiring are the same as for an NJ-series Standard CPU Unit. Refer to the *NJ/NX-series CPU Unit Software User's Manual* (Cat. No. W501) for detailed operating procedures for an NJ-series Standard CPU Unit.

This section provides details on above steps 2 (creating the GEM setting data), 3 (creating the SECS/GEM operation programming), and 4 (debugging).

## 3-2 Using the SECS/GEM Configurator to Create the GEM Setting Data

You use the SECS/GEM Configurator to create the GEM setting data and transfer it to the Controller. Use the following procedure to create the GEM setting data. The meaning of each setting and reference pages are also given.

Step No.	Setting	Description	Reference
1	Folder Setting	You set the computer folder in which to save the project data.	<i>Folder Settings</i> on page 8-26
2	Project Creation	You create a new project. You set the project name.	<i>Project Creation</i> on page 8-8
3	Importing Controller Variables	You use the Sysmac Studio to import previously defined global variables if you need to use them as controller variables.	<i>Controller Variable</i> on page 8-27
4	HSMS Communications Settings	You set the conditions for HSMS communications.	<i>8-8-1 HSMS Condition</i> on page 8-43
5	Item Definitions	You set the item definitions.	<i>8-9-1 Item</i> on page 8-45
6	Variable Data Definitions	You set the definitions for equipment constants, status variables, and discrete variables.	<i>8-9-2 Equipment Constant (EC)</i> on page 8-47 <i>8-9-3 Status Variable (SV)</i> on page 8-50 <i>8-9-4 Discrete Variable (DV)</i> on page 8-53
7	State Model Settings	You make settings for the communications state model and control state model.	<i>8-10-1 Communications State Model</i> on page 8-58 <i>8-10-2 Control State Model</i> on page 8-59
8	GEM Capability Settings	You make settings for the GEM capabilities.	<i>8-11 GEM Capability Settings</i> on page 8-60
9	Message Settings	You make settings for GEM messages and user-defined messages.	<i>8-12-1 GEM Standard Messages</i> on page 8-95 <i>8-12-2 User-defined Messages</i> on page 8-96
10	GEM Service Log Settings	You set the numbers of records saved in the GEM Service logs.	<i>8-7-1 GEM Service Log</i> on page 8-42
11	Building	You check the set data for errors and create the GEM setting data.	<i>Build</i> on page 8-19
12	Controller Connection Settings	You set the conditions for connections between the host and Controller.	<i>Connection Settings</i> on page 8-21
13	Transferring the GEM Setting Data	You transfer the GEM setting data to the Controller.	<i>Transfer to Controller</i> on page 8-22



## Precautions for Correct Use

---

### Transfer Settings

You must make FTP settings on the Controller to transfer the GEM setting data from the SECS/GEM Configurator to the Controller. Set the FTP settings on the Controller to enable using the FTP server.

Refer to the *NJ/NX-series CPU Unit Software User's Manual* (Cat. No. W501) for the procedure to set the Controller FTP settings from the Sysmac Studio.

### Setting Sequence

The conditions for the GEM capability settings that are related to the items depend on the formats, data sizes, and other item attributes set in the item definitions on the SECS/GEM Configurator. In addition, the link variable data types depend on the item attributes and GEM capability settings. Therefore, make the settings in the following order. If you use any other order, link variables may not be assigned correctly and errors may occur when you build the project.

1. Item definitions → 2. Variable data definitions → 3. GEM capability settings

---

## 3-3 Using the Sysmac Studio to Create the SECS/GEM Operation Programming

You use the Sysmac Studio to create the SECS/GEM programming. Use the following procedure to create the programming.

- 1** Start the Sysmac Studio and create a project.
- 2** Make the FTP settings.
- 3** Create the SECS/GEM operation programming.

Details for each step in the procedure are provided below.

### 3-3-1 Starting the Sysmac Studio and Creating a Project

To start the Sysmac Studio, use the Windows Start Menu or double-click the Sysmac Studio shortcut icon on your desktop.

Enter the project name in the Project Window. Set the device to NJ501-1340 in the Select Device Area. Click the **Create** Button. A new project is created.

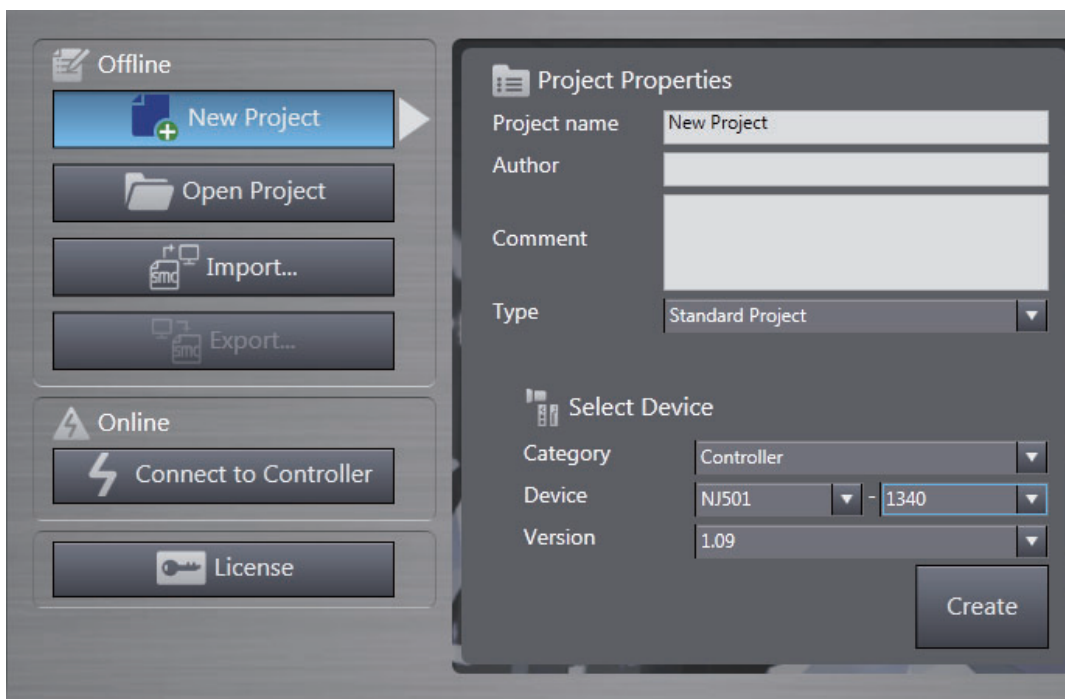

### 3-3-2 FTP Settings

FTP is used to transfer the GEM setting data from the SECS/GEM Configurator to the SECS/GEM CPU Unit. You must therefore make the FTP settings on the Sysmac Studio.

Use the following procedure to make the FTP settings.

- 1 Double-click **Built-in EtherNet/IP Port Settings** under **Configurations and Setup - Controller Setup** in the Multiview Explorer and select **Edit**.
- 2 Make the FTP settings on the Built-in EtherNet/IP Port Setting Tab Page.

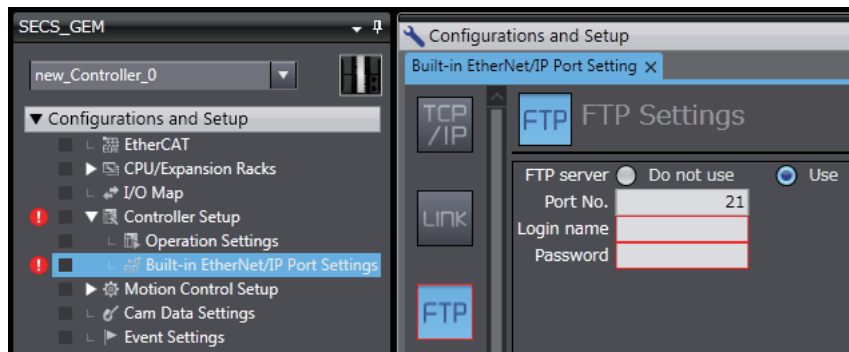

Refer to the *NJ/NX-series CPU Unit Software User's Manual* (Cat. No. W501) for details on the FTP settings on the Sysmac Studio.

### 3-3-3 Creating the SECS/GEM Operation Programming

The basic programming operations performed on the Sysmac Studio are the same as for an NJ-series Standard CPU Unit.

This section describes the processing procedures for SECS/GEM operation programming. Write the user program so that it performs the following processing.

Step No.	Processing	Meaning	Reference
1	Starting the GEM Services	---	4-1 <i>Starting the GEM Services</i> on page 4-2
2	Ending the GEM Services	Executing a shutdown.	4-2 <i>Ending the GEM Services</i> on page 4-3
3	Operation processing of the host connection function	The operation conditions are set for the GEM Services and the host connection function is operated.	5-1-1 <i>Starting and Pausing the Host Connection Function</i> on page 5-3
4	GEM capability processing	Processing is performed for the GEM capabilities.*1	5-5 <i>GEM Capabilities</i> on page 5-26

\*1. When you create the SECS/GEM operation programming and the link variables are already registered on the SECS/GEM Configurator, export the link variables from the SECS/GEM Configurator and import them to the Sysmac Studio.

You use the GEM instructions to create the SECS/GEM programming. For details, refer to the sample programs given in *A-1 GEM Instructions* on page A-3.

The GEM instructions are displayed in the SECS/GEM instruction category in the Toolbox on the Sysmac Studio.

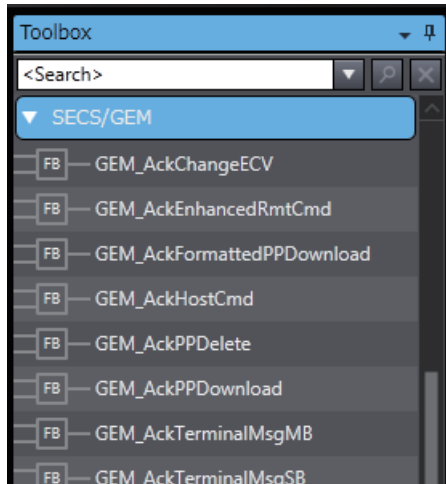

### 3-3-4 Restrictions When Defining Link Variables for User-defined Variables

The following restrictions apply when you define link variables for user-defined variables.

- You cannot use the prohibited characters in the variable names. Refer to the *NJ/NX-series CPU Unit Software User's Manual* (Cat. No. W501) for details on the prohibited characters.
- You cannot use the multi-byte characters in the variable names.
- You cannot use \_ (an underline) as the first character in a variable name.
- The maximum size of a variable name is 127 bytes excluding the NULL character.
- You cannot use the following data types: LINT, ULINT, TIME, DATE, TIME\_OF\_DAY, DATE\_AND\_TIME, structures, unions, and enumerations.
- Refer to 2-3-3 *Link Variables* on page 2-14 for the specified link variable attributes.

## 3-4 Debugging

You connect to the host or a Host Simulator to debug the GEM setting data and SECS/GEM operation programming.

The following debugging is performed when designing and commissioning the system.

Stage	Connection	Description
During design work	Host Simulator	You check to see if the GEM Services respond to test messages correctly according to host communications specifications.
When commissioning the system	Host	You check the event logs, <sup>*1</sup> GEM Service logs, <sup>*2</sup> and status given in system-defined variables <sup>*3</sup> to see if they are correct.

\*1. Refer to *Section 9 Troubleshooting* for details.

\*2. Refer to *Section 6 GEM Service Logs* for details.

\*3. Refer to *A-2 System-defined Variables* on page A-211 for details.



### Precautions for Correct Use

You can use the simulations on the Sysmac Studio to check the operation of the SECS/GEM operation programming. However, the GEM Services will not operate during simulation execution. Therefore, the following precautions apply.

- The system-defined variables that are related to GEM will not change from the default initial values for the data types.
- The user-defined variables that are related to GEM will not change from the initial values set in the variable table.
- If a GEM instruction is executed, only an input variable check is made without any consideration of the GEM Service status of the settings made on the SECS/GEM Configurator. If no problems are found, the instruction will end normally.



### Additional Information

Use the following procedure to use the Host Simulator.

Step No.	Meaning	Reference
1	Output an SML file from the SECS/GEM Configurator.	<i>Create SML File</i> on page 8-18
2	Read the SML file from the Host Simulator.	---
3	Check the operation of the SECS messages on the Host Simulator.	---

Ask where you purchased the Host Simulator for details on the Host Simulator.







# Functions Related to All GEM Services

This section describes functions that are related to all GEM Services, such as starting and stopping the GEM Services and the GEM Service status.

---

<b>4-1 Starting the GEM Services</b> .....	<b>4-2</b>
4-1-1 Procedure to Change the GEM Service Status to Run .....	4-2
4-1-2 Conditions That Prevent the GEM Service Status from Entering Run .....	4-2
<b>4-2 Ending the GEM Services</b> .....	<b>4-3</b>
4-2-1 Executing a Shutdown .....	4-3
4-2-2 Operation When Shutdown Processing Is Completed .....	4-3
<b>4-3 GEM Service Status</b> .....	<b>4-4</b>
4-3-1 GEM Service Status .....	4-4
4-3-2 Changes in the GEM Service Status .....	4-5
4-3-3 Checking the GEM Service Status .....	4-6
4-3-4 Relation between GEM Service Status and GEM Instructions .....	4-7

## 4-1 Starting the GEM Services

To start the GEM Services, you must change the GEM Service status to Run. Refer to 4-3 *GEM Service Status* on page 4-4 for the GEM Service status and the procedure to check the current GEM Service status.

### 4-1-1 Procedure to Change the GEM Service Status to Run

Use the following procedure to change the GEM Service status to Run.

- 1** Turn ON the power supply to the Controller.  
The GEM Service status is Idle.
- 2** Change the operating mode of the CPU Unit to RUN mode.  
The GEM Service status changes to Initializing and then to Run.

When the GEM Services start, the following event is registered.

Event code	Event name	Level
95420000 hex	GEM Service Started	Information

### 4-1-2 Conditions That Prevent the GEM Service Status from Entering Run

The causes, corrections, and registered events when the GEM Service status does not change to Run are given in the following table.

Cause	Correction	Registered event
The GEM setting data is corrupted.*1	9-2 <i>Errors Related to SECS/GEM</i> on page 9-3	Invalid GEM Setting Data (14E00000 hex)
The link variables used by the GEM Services are not registered as global variables for the user program. Or, the registered attributes*2 are not the same.*1	9-2 <i>Errors Related to SECS/GEM</i> on page 9-3	Illegal Variable Allocation (35400000 hex)
The GEM Service status is Stop.	Release Stop from the SECS/GEM Configurator.	No event is registered.
A major fault has occurred.	Use the Troubleshooter to identify the cause and remove the cause.	The registered event depends on the cause of the error.

\*1. The GEM Service status changes to Error.

\*2. The following five attributes are included: variable name, data type, constant, number of array dimensions, and number of array elements.

## 4-2 Ending the GEM Services

If you turn OFF the power supply to the CPU Unit while the GEM Services are in operation, the GEM setting data, GEM Service logs, or spool data may be corrupted. To prevent corruption, you must always end the GEM Services before you turn OFF the power supply to the CPU Unit.

You can use the following two methods to end the GEM Services.

- Execute a shutdown.
- Change the operating mode of the CPU Unit to PROGRAM mode.

### 4-2-1 Executing a Shutdown

You can use the following two ways to execute a shutdown.

- Execute the Shutdown GEM Service (GEM\_Shutdown) instruction.
- Execute a shutdown from the SECS/GEM Configurator.

#### Executing the Shutdown GEM Service (GEM\_Shutdown) Instruction

Use the following procedure to use the GEM\_Shutdown instruction to execute a shutdown.

- 1 Execute the GEM\_Shutdown instruction.
- 2 Confirm that the value of the `_GEM_ServiceStatus.Shutdown` system-defined variable changes to TRUE and then turn OFF the power supply to the CPU Unit.

#### Executing a Shutdown from the SECS/GEM Configurator

Select **GEM Service Operation – Shutdown** from Controller Menu of the SECS/GEM Configurator. Refer to *GEM Service Operation* on page 8-25 for details.



##### Precautions for Correct Use

- When you execute a shutdown, the GEM Service status changes to Shutdown. To change the GEM Service status from Shutdown back to Run, you must cycle the power supply to the CPU Unit.
- We recommend that you use a UPS (uninterruptible power supply) to prevent losing file due to power interruptions. The capacity of the NJ-series NJ-P□3001 Power Supply Unit is not sufficient to maintain the power supply to the CPU Unit from when the power supply is interrupted until the GEM Services are shut down.

### 4-2-2 Operation When Shutdown Processing Is Completed

The following event is registered when shutdown processing is completed after you execute a shutdown.

Event code	Event name	Level
95430000 hex	Shutdown Completed	Information

## 4-3 GEM Service Status

There are different operating status for the GEM Services. The functions that you can use depend on the operating status. Therefore, to use the GEM Services you must be aware of the current operating status.

### 4-3-1 GEM Service Status

The following table describes the GEM Service status. The table gives the definition of each status and the system-defined variables that can be used.

Operating status	Definition	System-defined variables
Idle	The GEM Services are not started. CPU Unit is in PROGRAM mode.	*1
Initializing	The GEM Services are reading the GEM setting data and checking the data.	*1
Run*2	The GEM Services are operating.	---
EQStarting	The GEM Services are started but not yet initialized.	Can be used.
EQInitializing	Initialization of the host connection function, such as homing, is in progress.	Can be used.
EQRun	Host communications are possible.	Can be used.
Stop	The GEM Services are stopped, but not due to an error. This status is used to download the GEM setting data from the SECS/GEM Configurator.	*1
Error	The GEM Services are stopped due to an error.	*1
ShuttingDown	Processing to shut down the GEM Services is in progress.	*1
Shutdown	The GEM Services are shut down. You can turn OFF the power supply to the Controller in this status.	*1

\*1. You can use only the `_GEM_ServiceStatus` system-defined variable. The values of all other GEM system-defined variables are undefined.

\*2. Refer to 5-1-1 *Starting and Pausing the Host Connection Function* on page 5-3 for details on Run.

### 4-3-2 Changes in the GEM Service Status

You can change the GEM Service status with SECS/GEM Configurator operations or with instruction execution. The changes in the GEM Service status are shown in the following diagram.

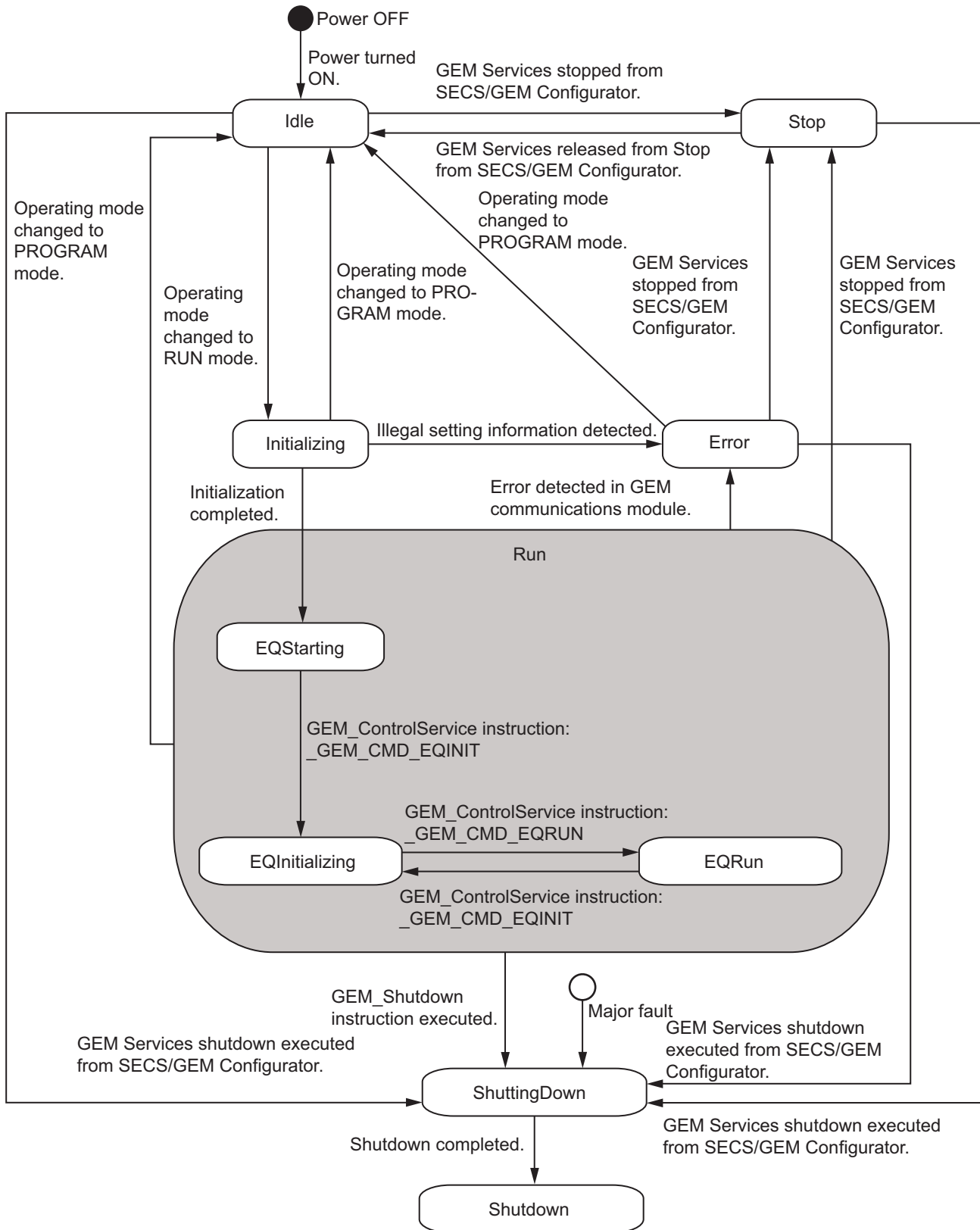

4-3 GEM Service Status

4

4-3-2 Changes in the GEM Service Status

### 4-3-3 Checking the GEM Service Status

There are the following two ways to confirm the current GEM Service status.

- `_GEM_ServiceStatus` system-defined variable
- GEM Service operations from the SECS/GEM Configurator

#### Checking with `_GEM_ServiceStatus`

The `_GEM_ServiceStatus` system-defined variable is a structure with ten members that give the operating status. The members with a value of TRUE indicate the current GEM Service status. The members of `_GEM_ServiceStatus` are given in the following table.

<code>_GEM_ServiceStatus</code> member	Name
Idle	Idle
Initializing	Initializing
Run <sup>*1</sup>	Run
EQStarting	EQStarting
EQInitializing	EQInitializing
EQRun	EQRun
Stop	Stop
Error	Error
ShuttingDown	ShuttingDown
Shutdown	Shutdown

\*1. The value of `_GEM_ServiceStatus.Run` will be TRUE for any of the following status: EQStarting, EQInitializing, or EQRun.

#### Confirming with the SECS/GEM Configurator

Use the GEM Service Operation Menu in the menu bar on the SECS/GEM Configurator. For details on the GEM Service Operation Menu, refer to *GEM Service Operation* on page 8-25.

### 4-3-4 Relation between GEM Service Status and GEM Instructions

The GEM instructions that you can use depend on the GEM Service status. The following table shows the GEM instructions and the GEM Service status in which you can use them.

GEM instruction	GEM Service Status								
	Idle	Initial-izing	Run			Stop	Error	Shut-ting-Down	Shut-down
			EQStart-ing	EQIni-tializ-ing	EQRun				
GEM_Control Service			Usable *1	Usable *2	Usable *1				
GEM_Shutdown			Usable	Usable	Usable	Usable	Usable		
GEM_GetComm Log				Usable	Usable				
GEM_SetHSMS Param				Usable	Usable				
GEM_Change CommState					Usable				
GEM_Change ControlState					Usable				
GEM_InitEvent				Usable					
GEM_Report Event					Usable				
GEM_Report Alarm					Usable				
GEM_AckHost Cmd					Usable				
GEM_Ack EnhancedRmt Cmd					Usable				
GEM_Change ECV				Usable	Usable				
GEM_Ack ChangeECV					Usable				
GEM_AckPP Delete					Usable				
GEM_Resp FormattedPP Upload					Usable				
GEM_RespPP Upload					Usable				
GEM_Upload FormattedPP					Usable				
GEM_UploadPP					Usable				
GEM_Ack FormattedPP Download					Usable				
GEM_AckPP Download					Usable				
GEM_Request FormattedPP Download					Usable				
GEM_RequestPP Download					Usable				

GEM instruction	GEM Service Status								
	Idle	Initial-izing	Run			Stop	Error	Shut-ting-Down	Shut-down
			EQStart-ing	EQIni-tializ-ing	EQRun				
GEM_SendPP Verify					Usable				
GEM_Send TerminalMsg					Usable				
GEM_Ack TerminalMsgSB					Usable				
GEM_Ack TerminalMsgMB					Usable				
GEM_Request ChangeTime					Usable				
GEM_SendEquip UserMsg					Usable				
GEM_RespHos- tUserMsg					Usable				

\*1. Usage is possible if `_GEM_CMD_EQINIT` is specified for the *Cmd* input variable.

\*2. Usage is possible if `_GEM_CMD_EQRUN` is specified for the *Cmd* input variable.



# 5

## Host Connection Function

The host connection function is located between the host and the user program. This software handles SECS messages with the host and exchanges data with the user program. This section provides detailed information on the host connection function.

<b>5-1 Basic Processing of the Host Connection Function</b>	<b>5-3</b>
5-1-1 Starting and Pausing the Host Connection Function	5-3
5-1-2 Interlocks	5-5
5-1-3 Transaction Processing	5-6
5-1-4 Checking the Number of Buffered SECS Messages	5-12
<b>5-2 HSMS Communications</b>	<b>5-14</b>
5-2-1 Setting HSMS Conditions	5-14
5-2-2 HSMS Communications Connection States	5-15
5-2-3 Checking the HSMS Communications State	5-16
<b>5-3 Item Definitions</b>	<b>5-17</b>
<b>5-4 Variable Data Definitions</b>	<b>5-21</b>
5-4-1 Types of Variable Data	5-21
5-4-2 Link Variables for Variable Data	5-21
5-4-3 List Specifications for Variable Data	5-22
5-4-4 Standard Variable Data	5-24
<b>5-5 GEM Capabilities</b>	<b>5-26</b>
5-5-1 Communications State Model	5-27
5-5-2 Control State Model	5-31
5-5-3 Equipment Processing States	5-37
5-5-4 Event Notification	5-40
5-5-5 Error Messages	5-43
5-5-6 Documentation	5-44
5-5-7 Dynamic Event Report Configuration	5-45
5-5-8 Variable Data Collection	5-48
5-5-9 Trace Data Collection	5-49
5-5-10 Status Data Collection	5-51
5-5-11 Alarm Management	5-53
5-5-12 Host Commands	5-56
5-5-13 Enhanced Remote Commands	5-60
5-5-14 Equipment Constants	5-62
5-5-15 Process Program Management	5-66

5-5-16	Material Movement	5-87
5-5-17	Equipment Terminal Service	5-88
5-5-18	Clock	5-91
5-5-19	Limit Monitoring	5-93
5-5-20	Spooling	5-96
<b>5-6</b>	<b>Message Settings</b>	<b>5-102</b>
5-6-1	GEM Standard Messages	5-102
5-6-2	User-defined Messages	5-104

# 5-1 Basic Processing of the Host Connection Function

The host connection function must be started separately from the GEM Services. You can also temporarily stop the host connection function.

The basic processing performed by the host connection function includes the following.

- Interlocks
- Transaction processing
- Checking the number of buffered SECS messages

## 5-1-1 Starting and Pausing the Host Connection Function

You can use the following methods to start and temporarily stop the host connection function.

### Starting the Host Connection Function

The host connection function can be used when the GEM Service status is EQRun. The procedure to start the host connection function is given below.

- 1 Specify EQInitializing and execute the GEM Service Control (GEM\_ControlService) instruction. The GEM Service status changes to EQInitializing.

Non-retained status variables, non-retained discrete variables, and non-retained system-defined variables are set to their default settings.

- 2 Perform initial settings for the following items as required.

Item	Reference
HSMS conditions	5-2 HSMS Communications on page 5-14
Equipment constants	5-4 Variable Data Definitions on page 5-21
Status variables	5-4 Variable Data Definitions on page 5-21
Communications state model	5-5-1 Communications State Model on page 5-27
Control state model	5-5-2 Control State Model on page 5-31
Interlock variables	5-1-2 Interlocks on page 5-5
Initialize event reports that are dynamically set by the host.	GEM_InitEvent on page A-38
Initialize the GEM capabilities.	5-5 GEM Capabilities on page 5-26

- 3 Specify EQRun and execute the GEM\_ControlService instruction. The GEM Service state will change to EQRun.



#### Precautions for Correct Use

The contents of the GEM setting data that is uploaded with the SECS/GEM Configurator is the same as the contents of the GEM setting data that was previously downloaded with the SECS/GEM Configurator. Even if the settings in the downloaded GEM setting data were changed by the user program or host, the changes will not be reflected in the uploaded GEM setting data.

## Pausing the Host Connection Function

---

When the GEM Service status changes from EQRun to EQInitializing, the host connection function is temporarily stopped. The status is as follows while the host connection function is temporarily stopped:

- Communications with the host stop.
- Non-retained status variables and non-retained discrete variables are initialized.

To temporarily stop the host connection function, specify EQInitializing and execute the GEM Service Control (GEM\_ControlService) instruction.

To restart the host connection function, execute steps 2 and 3 in the procedure to start the host connection function.

## 5-1-2 Interlocks

Interlocks prevent the equipment from executing processing requested by the host. An interlock is enabled by changing the value of the interlock variable for the relevant processing to TRUE in the user program. It is disabled when the value is changed to FALSE.

When an interlock is in effect, the host connection function returns a secondary message saying that processing is not possible for the primary message from the host.

The interlock variables and the processing that is performed when an interlock is in effect are given in the following table.

Interlock variable	Processing
_GEM_Interlock_ControlState	Going online is denied even if Request ON-LINE (S1,F17) is received from the host.
_GEM_Interlock_ECV	Changing an equipment constant is denied even if New Equipment Constant Send (S2,F15) is received from the host.
_GEM_Interlock_HostCmd	The host command is denied even if Host Command Send (S2,F41) is received from the host.
_GEM_Interlock_EnhancedRmtCmd	The enhanced host command is denied even if Enhanced Remote Command (S2,F49) is received from the host.
_GEM_Interlock_PP	Processing is denied even if the following SECS messages are received from the host. <ul style="list-style-type: none"> <li>• Process Program Request (S7,F5)</li> <li>• Formatted Process Program Request (S7,F25)</li> <li>• Process Program Load Inquire (S7,F1)</li> <li>• Process Program Send (S7,F3)</li> <li>• Formatted Process Program Send (S7,F23)</li> <li>• Delete Process Program Send (S7,F17)</li> </ul>
_GEM_Interlock_Time	Changing the equipment clock is denied even if Date and Time Set Request (S2,F31) is received from the host.



### Precautions for Correct Use

The requested processing may be performed for processing requests received from the host immediately after the value of the interlock variable changes to TRUE. Set interlock variables as soon as possible.

### 5-1-3 Transaction Processing

The series of processing that is performed by the SECS/GEM CPU Unit for a SECS message is called transaction processing. Some transactions are processed jointly by the host connection function and the user program, and others are processed only by the host connection function. For the transactions that are processed jointly by the host connection function and user program, you can use the following variables in the user program to check the transaction processing state, processing result, and processing result factor. The values of these variables are updated by the host connection function.

Variable type	Meaning	Data type	Meanings of values
Transaction processing flag	Transaction processing state	BOOL	TRUE: Transaction processing is in progress. FALSE: Transaction processing is not in progress.
Transaction processing result variable	Transaction processing result and result factor	Structure	Refer to the following table.

The members of the transaction processing result variable are given in the following table.

Member	Meaning	Data type	Meanings of values	Description
Rslt	Processing result	BOOL	TRUE: Successful FALSE: Failed	
Rslt Code	Processing result factor	WORD	16#0000: Successful	
			16#0100: Transmission error	<ul style="list-style-type: none"> <li>The communications state was DISABLED or NOT COMMUNICATING when the primary message was received.</li> <li>The control state was OFF-LINE when the primary message was received.</li> <li>The spool status was SPOOL ACTIVE when the primary message was received.</li> </ul>
			16#0200: Reception error	<ul style="list-style-type: none"> <li>A T3 timeout occurred while reception of the secondary message is awaited. <sup>*1</sup></li> <li>The communications state changed to DISABLED while reception of the secondary message is awaited.</li> <li>The control status changed to OFF-LINE while the secondary message is awaited.</li> <li>The received secondary message exceeded the maximum size of a SECS message. <sup>*2</sup></li> <li>The message structure of the received secondary message was not correct. <sup>*3</sup></li> </ul>
			16#0300 or higher: Specific errors	This depends on the transaction result processing variable. Refer to <i>A-2 System-defined Variables</i> on page A-211 for details.

\*1. The host connection function sends Transaction Timer Timeout (S9,F9).

\*2. The host connection function sends Data Too Long (S9,F11).

\*3. The host connection function sends Illegal Data (S9,F7).

Transaction processing is different when the host sends the primary message in comparison with when the equipment sends the primary message.

## When Host Sends the Primary Message

Transaction processing is as described below when the host sends the primary message.

- 1** The host sends the primary message.
- 2** The host connection function determines if the received primary message is normal.  
The normal/error results and factors, and the host connection function processing for each, are given in the following table.

Result	Factor	Host connection function processing
Normal	---	Changes the transaction processing flag to TRUE.
Error*1	The message structure of the primary message from the host is nonstandard.	Sends Unrecognized Function Type (S9,F5) to the host.
	The communications state was DISABLED when the primary message was received from the host.	The primary message is discarded.
	The control state was OFF-LINE when the primary message was received from the host.	Sends Abort Transaction (S7,F0) to the host.
	The stream number in the primary message from the host is not supported by the GEM Services.	Sends Unrecognized Stream Type (S9,F3) to the host.
	The function number in the primary message from the host is not supported by the GEM Services.	Sends Unrecognized Function Type (S9,F5) to the host.
	The W bit setting in the primary message from the host is OFF.	Sends Unrecognized Function Type (S9,F5) to the host.
	The primary message from the host was disabled on the SECS/GEM Configurator. *2	Sends Unrecognized Function Type (S9,F5) to the host.
	The message structure or format of the primary message from the host is different from the structure or format set in the SECS/GEM Configurator.	Sends Illegal Data (S9,F7) to the host.
	SECS message-specific factors	Refer to information on individual GEM capabilities.

\*1. The same error determination is executed for all primary messages from the host.

\*2. Settings to enable and disable primary messages are checked for GEM standard messages and user-defined messages.

- 3** The host connection function changes the value of the transaction processing flag for the received primary message.
- 4** The user program detects that the value of the transaction processing flag is TRUE.
- 5** The user program processes the primary message and executes a GEM instruction.
- 6** The host connection function changes the value of the transaction processing flag to FALSE.
- 7** The host connection function returns a secondary message.

The following figure shows a timing chart.

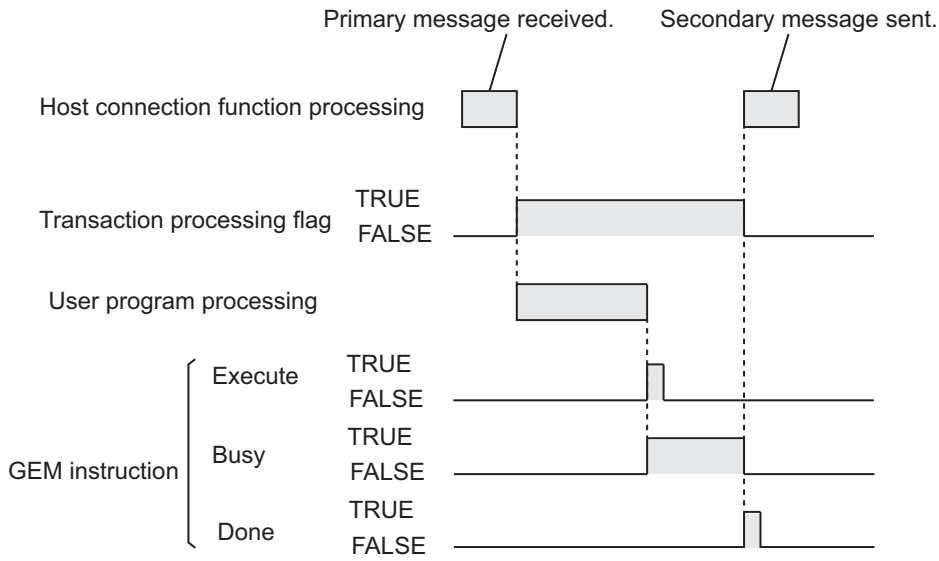

**Precautions for Correct Use**

If the next primary message is received after the equipment receives a primary message but before it returns the secondary message, the user program detects reception of the second primary message only after the secondary message is returned for the first primary message.



The transaction processing flags that are used when the host sends the primary message are given in the following table. Both the SECS messages that change the values of the transaction processing flags to TRUE and the GEM instructions that change the values of the transaction processing flags to FALSE are given.

Transaction Processing Flag		SECS message	GEM instruction
Variable	Name		
_GEM_BusyHost ChangeECV	Host-initiated Equipment Constant Change	New Equipment Constant Send (S2,F15)	GEM_AckChangeECV
_GEM_BusyHostCmd	Host Command	Host Command Send (S2,F41)	GEM_AckHostCmd
_GEM_BusyEnhanced RmtCmd	Enhanced Remote Command	Enhanced Remote Com- mand (S2,F49)	GEM_AckEnhanced RmdCmd
_GEM_BusyHostPP Delete	Host-initiated Process Program Deletion	Delete Process Program Send (S7,F17)	GEM_AckPPDelete
_GEM_BusyHost FormattedPPUpload	Host-initiated Formatted Process Program Upload	Formatted Process Pro- gram Request (S7,F25)	GEM_Resp FormattedPPUpload
_GEM_BusyHostPP Upload	Host-initiated Process Program Upload	Process Program Request (S7,F5)	GEM_RespPPUpload
_GEM_BusyHost FormattedPP Download	Host-initiated Formatted Process Program Download	Formatted Process Pro- gram Send (S7,F23)	GEM_Ack FormattedPP Download
_GEM_BusyHost PPDownload	Host-initiated Process Program Download	Process Program Send (S7,F3)	GEM_AckPP Download
_GEM_BusyHost TerminalMsgSB	Host-initiated Single-block Terminal Message	Terminal Display, Single (S10,F3)	GEM_AckTerminalMsg SB
_GEM_BusyHost TerminalMsgMB	Host-initiated Multi-block Terminal Message	Terminal Display, Multi-block (S10F5)	GEM_AckTerminalMsg MB
_GEM_BusyHostUser Msg	Host-initiated User-defined Message	Host-initiated User-defined Message (Sx,Fy)	GEM_SendHostUser Msg

## When Equipment Sends the Primary Message

Transaction processing is as described below when the equipment sends the primary message.

- 1** A GEM instruction is executed in the user program.
- 2** When execution of the GEM instruction is completed, the GEM Service changes the value of the transaction processing flag for the GEM instruction to TRUE.
- 3** The host connection function sends the primary message.
- 4** The host returns the secondary message.
- 5** The host connection function receives the secondary message.
- 6** The host connection function changes the value of the transaction processing flag to FALSE.
- 7** The user program detects that the value of the transaction processing flag is FALSE.
- 8** The user program uses the transaction processing result variable to check the results of transaction processing.

The following figure shows a timing chart.

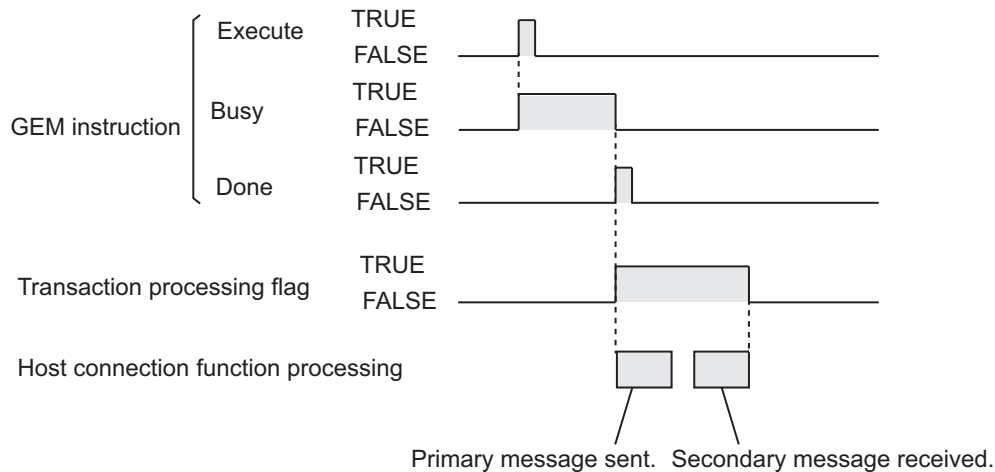

The value of the transaction processing flag changes to FALSE regardless of whether transaction processing ends normally or end in an error.

The transaction processing flags and the transaction processing result variables that are used when the equipment sends the primary message are given in the following table. Both the GEM instructions that change the values of the transaction processing flags to TRUE and the SECS messages that change the values of the transaction processing flags to FALSE are given.

Transaction processing flag		Transaction processing result variable		GEM instruction	SECS message
Variable	Name	Variable	Name		
_GEM_Busy EquipChange Time	Equipment- initiated Time Change	_GEM_Equip ChangeTime RsIt	Equipment- initiated Time Change Results	GEM_Request ChangeTime	Date and Time Data (S2,F18)
_GEM_Busy Equip FormattedPP Upload	Equipment- initiated Formatted Process Program Upload	_GEM_Equip FormattedPP UploadRsIt	Equipment- initiated Formatted Process Program Upload Results	GEM_Upload FormattedPP	Formatted Process Program Acknowl- edge (S7,F24)
_GEM_Busy EquipPP Upload	Equipment- initiated Process Program Upload	_GEM_Equip PPUploadRsIt	Equipment- Initiated Process Program Upload Results	GEM_UploadPP	Process Program Acknowledge (S7,F4)
_GEM_Busy Equip FormattedPP Download	Equipment- initiated Formatted Process Program Download	_GEM_Equip FormattedPP DownloadRsIt	Equipment- initiated Formatted Process Program Download Results	GEM_Request FormattedPP Download	Formatted Process Program Data (S7,F26)
_GEM_Busy EquipPP Download	Equipment- initiated Process Program Download	_GEM_Equip PPDownload RsIt	Equipment- initiated Process Program Download Results	GEM_Request PPDownload	Process Program Data (S7,F6)
_GEM_Busy Equip TerminalMsg	Equipment- initiated Terminal Message	_GEM_Equip TerminalMsg RsIt	Equipment- initiated Terminal Message Results	GEM_Send TerminalMsg	Terminal Request Acknowledge (S10,F2)
_GEM_Busy EquipUser Msg	Equipment- initiated User-defined Message	_GEM_Equip UserMsgRsIt	Send Equipment- initiated User-defined Message Results	GEM_Send EquipUserMsg	Equipment- initiated User-defined Message (Sx,Fy+1)

### 5-1-4 Checking the Number of Buffered SECS Messages

Processing of GEM Services is performed in the system services of the SECS/GEM CPU Unit. The execution priority of the system services is lower than the execution priority of the primary periodic task and priority-16 periodic task. Other than processing for the GEM Services, the system services also provide the USB port service, built-in EtherNet/IP port service, and other services. Therefore, transmission delays will occur if a lot of SECS messages are sent and received. SECS messages for which there are delays are buffered until they are sent.

Refer to the *NJ/NX-series CPU Unit Software User's Manual* (Cat. No. W501) for details on system services and the execution priority of processes.

#### System-defined Variables for Number of Buffered SECS Messages

You can check the number of buffered SECS messages with the following system-defined variables.

Variable	Meaning	Data type	Range of values
_GEM_EquipMsgBuf	Equipment-initiated Message Bufferings	USINT	0 to 32
_GEM_HostMsgBuf	Host-initiated Message Bufferings	USINT	0 to 16

#### Operation When Number of Buffered Messages Exceeds Allowed Value

Operation when the number of buffered equipment-initiated messages exceeds the allowed value is described in the following table.

Item	Operation
Event log	The Send Transaction Queue Overrun (66000000 hex) observation is recorded in the event log.
Instruction execution	The instruction ends in an error with error code 16#381B (Insufficient Transaction Resource).
Sending SECS messages to the host	The messages are not sent.
Receiving SECS messages from the host	The messages are received normally.

Operation when the number of buffered host-initiated messages exceeds the allowed value is described in the following table.

Item	Operation
Event log	The Receive Transaction Queue Overrun (66010000 hex) observation is recorded in the event log.
Instruction execution	The instruction is executed normally.
Receiving SECS messages from the host	After the message is received, Abort Transaction (Sx,F0) is sent in reply.*1
User program notification	The user program is not notified that the allowable number of buffered transactions was exceeded.

\*1. The stream number is the same as the stream number of the SECS message received from the host.

## How to Reduce the Number of Buffered SECS Messages

---

The effective ways to reduce the number of buffered SECS messages are as follows:

- Reduce the frequency of communications with the host.
- Reduce the task execution time ratio.

Refer to *A-4 Designing Tasks to Use the GEM Services* on page A-231 for details on how to adjust the task execution time ratio.

## 5-2 HSMS Communications

---

HSMS communications conforms to SEMI E37.10702 (High-speed SECS Message Service Single Selected-Session Mode) (HSMS-SS or HSMS-SSS).

### 5-2-1 Setting HSMS Conditions

There are the following two modes for establishing a TCP/IP connection between the host and equipment.

- Passive Mode: The host sends a connection request.
- Active Mode: The equipment sends a connection request.

The HSMS condition settings are different for Passive Mode and Active Mode.

You can use either the SECS/GEM Configurator or the Set HSMS Communications Parameters (GEM\_SetHSMSParam) instruction to set the HSMS conditions.

#### Setting with the SECS/GEM Configurator

---

You can set the HSMS conditions with the SECS/GEM Configurator. Refer to *8-8-1 HSMS Condition* on page 8-43 for details on the settings.

#### Executing the GEM\_SetHSMSParam Instruction

---

You can execute the GEM\_SetHSMSParam instruction to set the HSMS conditions. The settings in the instruction are applied when the GEM Service status changes to EQRun. Refer to *A-1 GEM Instructions* on page A-3 for information on the instruction.

### 5-2-2 HSMS Communications Connection States

The HSMS communications connection states operate according to the following HSMS state machine.

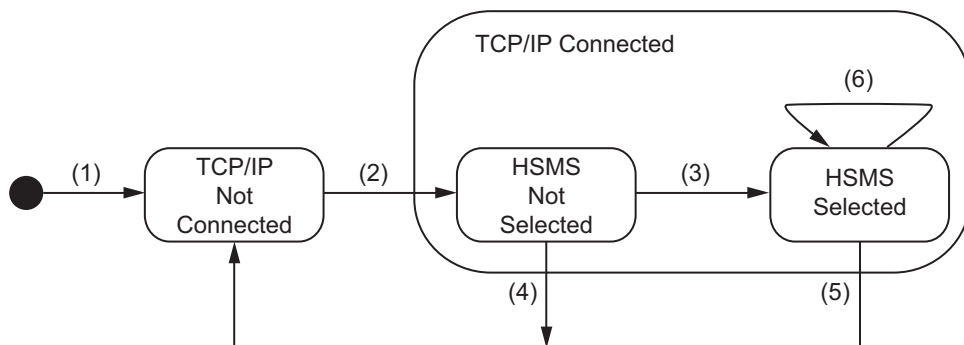

The state transition triggers and equipment operation in Passive Mode are described in the following table. The numbers in the table correspond to the numbers in the figure.

No.	Current state	Trigger	New state	Operation
(1)	---	The GEM Service status changed to EQRun.	TCP/IP NOT CONNECTED	None
(2)	TCP/IP NOT CONNECTED	TCP/IP successfully accepted.	HSMS NOT SELECTED	T7 timeout timer is started.
(3)	HSMS NOT SELECTED	<i>Select.req</i> is received and accepted.	HSMS SELECTED	T7 timeout is canceled and <i>Select.rep</i> with a Selected Status of 0 is sent.
(4)	HSMS NOT SELECTED	HSMS selection failed. The GEM Service status changed to a status other than EQRun.	TCP/IP NOT CONNECTED	The TCP/IP connection is closed.
(5)	HSMS SELECTED	TCP/IP communications end. The GEM Service status changed to a status other than EQRun.	TCP/IP NOT CONNECTED	The TCP/IP connection is closed.
(6)	HSMS SELECTED	T3 timeout occurs.	HSMS SELECTED	<ul style="list-style-type: none"> <li>The data transaction is canceled while the TCP/IP connection is not ended.</li> <li>For a primary message, Transaction Timer Timeout (S9,F9) is sent.</li> </ul>

The state transition triggers and equipment operation in Active Mode are described in the following table.

No.	Current state	Trigger	New state	Operation
(1)	---	Initialization	TCP/IP NOT CONNECTED	None
(2)	TCP/IP NOT CONNECTED	A connection is determined.	HSMS NOT SELECTED	<ul style="list-style-type: none"> <li>• TCP/IP Connect</li> <li>• <i>Select.req</i> is sent.</li> <li>• T6 timeout timer is started.</li> </ul>
(3)	HSMS NOT SELECTED	<i>Select.rep</i> with a Selected Status of 0 is received.	HSMS SELECTED	T6 timeout is canceled.
(4)	HSMS NOT SELECTED	HSMS selection failed. The GEM Service status changed to a status other than EQRun.	TCP/IP NOT CONNECTED	<ul style="list-style-type: none"> <li>• The TCP/IP connection is closed.</li> <li>• T5 timeout timer is started.</li> </ul>
(5)	HSMS SELECTED	TCP/IP communications end. The GEM Service status changed to a status other than EQRun.	TCP/IP NOT CONNECTED	The TCP/IP connection is closed.
(6)	HSMS SELECTED	T3 timeout occurs.	HSMS SELECTED	<ul style="list-style-type: none"> <li>• The data transaction is canceled while the TCP/IP connection is not ended.</li> <li>• For a primary message, Transaction Timer Timeout (S9,F9) is sent.</li> </ul>

To check the connection status in HSMS SELECTED state, the GEM Service periodically sends a link test request control message (*Linktest.req*).

If the GEM Service status is not EQRun, the HSMS communications state is always TCP/IP NOT CONNECTED.

### 5-2-3 Checking the HSMS Communications State

Use the following system-defined variables to check the HSMS communications state. Refer to A-2 *System-defined Variables* on page A-211 for details on system-defined variables.

Variable	Name	Function
_GEM_HSMState	HSMS Communications State	Gives the HSMS communications connection state.
_GEM_HSMSError	HSMS Communications Error	Indicates errors detected by the HSMS.
_GEM_HSMSParam	HSMS Communications Parameters	Gives the active HSMS communications settings.



## 5-3 Item Definitions

An item is a data element in a SECS message. You can check item definitions with **Data Definition - Item Definition** on the Tools Menu of the SECS/GEM Configurator. You can change the format or data size of some of the items on the SECS/GEM Configurator.

The names, meanings, formats, and data sizes of the items are given in the following table along with whether the values can be changed. The data size is given in the *Data size* column only when it is not implicit from the format. Refer to *A-3 Correspondence between Formats and Data Types* on page A-230 for the format codes and meanings, and the corresponding data types handled by the NJ-series CPU Units.

Item name	Meaning	Value changes	Format	Data size [bytes]
ABS	Any binary string	Not allowed.	B	1,024 max.
ACKC5	Acknowledge code	Not allowed.	B	1
ACKC6	Acknowledge code	Not allowed.	B	1
ACKC7	Acknowledge code	Not allowed.	B	1
ACKC7A	Acknowledge code	Not allowed.	U1	1
ACKC10	Acknowledge code	Not allowed.	B	1
ALCD	Alarm code	Not allowed.	B	1
ALED	Alarm enable/disable code	Not allowed.	B	1
ALID	Alarm identification	Allowed.	U1, U2, or U4 <sup>*1</sup>	
ALTX	Alarm text	Allowed.	A	120 max.
CCODE	Command code	Allowed.	A, I2, I4, U2, or U4	4 max. when the format is A
CEED	Collection event or trace enable/disable code	Not allowed.	BOOLEAN	
CEID	Collection event ID	Allowed.	U1, U2, or U4 <sup>*1</sup>	
CEPACK	Command Enhanced Parameter Acknowledge	Not allowed.	U1 <sup>*2</sup>	
CEPVAL	Command Enhanced Parameter Value	Not allowed.	B, BOOLEAN, A, I1, I2, I4, F8, U1, U2, or U4 <sup>*1*2*3*4*5</sup>	
COMMACK	Establish Communications Acknowledge Code	Not allowed.	B	1
CPACK	Command Parameter Acknowledge Code	Not allowed.	B	1
CPNAME	Command Parameter Name	Allowed.	A	60 max.
CPVAL	Command Parameter Value	Not allowed.	B, BOOLEAN, A, I1, I2, I4, U1, U2, or U4 <sup>*1*3*4*5</sup>	
DATAID	Data ID	Allowed.	U1, U2, or U4 <sup>*1</sup>	
DATALLENGTH	Total bytes to be sent	Allowed.	U1, U2, or U4 <sup>*1</sup>	
DRACK	Define Report Acknowledge Code	Not allowed.	B	1
DSPER	Data sample period	Not allowed.	A	6,8
EAC	Equipment acknowledge code	Not allowed.	B	1
ECDEF	Equipment constant default value	Not allowed.	Same as format for target ECV.	
ECID	Equipment constant ID	Not allowed.	Same as format of VID.	

Item name	Meaning	Value changes	Format	Data size [bytes]
ECMAX	Equipment constant maximum value	Not allowed.	Same as format for target ECV.	
ECMIN	Equipment constant minimum value	Not allowed.	Same as format for target ECV.	
ECNAME	Equipment constant name	Allowed.	---	60
ECV	Equipment constant value	Not allowed.	B, BOOLEAN, A, I1, I2, I4, F4, F8, U1, U2, or U4 <sup>*1*3*4*6</sup>	
EDID	Expected data identification	Not allowed.	Same as format of PPID.	
ERACK	Enable/Disable Event Report Acknowledge Code	Not allowed.	B	1
ERRW7	Text string describing error found in process program	Allowed.	A	80
FCNID	Function Identification	Not allowed.	U1	
GRANT	Grant code	Not allowed.	B	1
HCACK	Host Command Parameter Acknowledge Code	Not allowed.	B	1
LENGTH	Length of the service program or process program in bytes	Allowed.	U1, U2, or U4 <sup>*1</sup>	
LIMITACK	Acknowledgement code for variable limit attribute set	Not allowed.	B	1
LIMITID	The identifier of a specific limit in the set of limits for a variable to which the corresponding limit attributes refer	Not allowed.	B	1
LIMITMAX	The maximum allowed value for the limit values of a specific variable	Not allowed.	Same as format for monitoring target SV.	
LIMITMIN	The minimum allowed value for the limit values of a specific variable	Not allowed.	Same as format for monitoring target SV.	
LOWERDB	A variable limit attribute which defines the lower boundary of the deadband of a limit	Not allowed.	Same as format for monitoring target SV.	
LRACK	Link Report Acknowledge code	Not allowed.	B	1
LVACK	Variable limit definition acknowledge code	Not allowed.	B	1
MDLN	Equipment Model Type	Allowed.	---	20
MEXP	Message expected in the from Sxx,Fyy where x is stream and y is function	Not allowed.	A	6
MHEAD	SECS message block header associated with message block in error	Not allowed.	B	10
OBJSPEC	A text string that has an internal format and that is used to point to a specific object instance	Allowed.	A	80
OFLACK	Acknowledge code for OFF-LINE request	Not allowed.	B	1

Item name	Meaning	Value changes	Format	Data size [bytes]
ONLACK	Acknowledge code for ON-LINE request	Not allowed.	B	1
PPARM	Process Parameters	Not allowed.	BOOLEAN, A, I1, I2, I4, F4, F8, U1, U2, or U4 <sup>*1*4*7</sup>	
PPBODY	Process program body	Not allowed.	B, A, I1, I2, I4, U1, U2, or U4 <sup>*1*4*7</sup>	
PPGNT	Process program grant status	Not allowed.	B	1
PPID	Process program ID	Allowed.	A	120
RCMD	Remote command code or string	Allowed.	A	20
REPGSZ	Reporting group size	Allowed.	U1, U2, or U4 <sup>*1</sup>	
RPTID	Report ID	Allowed.	U1, U2, or U4 <sup>*1</sup>	
RSDA	Request Spool Data Acknowledge	Not allowed.	B	1
RSDC	Request Spool Data Code	Not allowed.	U1	
RSPACK	Reset Spooling Acknowledge	Not allowed.	B	1
SEQNUM	The value which indicates the position in the list of processing commands	Not allowed.	U2	
SHEAD	Stored header related to the transaction timer	Not allowed.	B	10
SMPLN	Sample Number	Allowed.	U1, U2, or U4 <sup>*1</sup>	
SOFTREV	Software revision code	Allowed.	A	20
STIME	Sample time	Not allowed.	A	12 or 16
STRACK	Spool Stream Acknowledge	Not allowed.	B	1
STRID	Stream Identification	Not allowed.	U1	
SV	Status variable value	Not allowed.	L, B, BOOLEAN, A, I1, I2, I4, F4, F8, U1, U2, or U4 <sup>*1*3*4*6</sup>	
SVID	Status variable ID	Not allowed.	Same as format of VID.	
SVNAME	Status Variable Name	Allowed.	A	60
TEXT	A single line of characters	Allowed.	A <sup>*1*3</sup>	240
TIAACK	Equipment acknowledgement code	Not allowed.	B	1
TIACK	Time Acknowledge Code	Not allowed.	B	1
TID	Terminal number	Not allowed.	B	1
TIME	Time of day	Not allowed.	A	12 or 16
TOTSMP	Total samples to be made	Allowed.	U1, U2, or U4 <sup>*1</sup>	
TRID	Trace request ID	Allowed.	U1, U2, or U4 <sup>*1</sup>	
UNITS	Unit Identifier	Allowed.	A	20
UPPERDB	A variable limit attribute which defines the upper boundary of the deadband of a limit	Not allowed.	L, B, BOOLEAN, A, I1, I2, I4, F4, F8, U1, U2, or U4	
V	Variable data	Not allowed.	L, B, BOOLEAN, A, I1, I2, I4, F4, F8, U1, U2, or U4 <sup>*1*3*4*6</sup>	
VID	Variable ID	Allowed.	U1, U2, or U4 <sup>*1</sup>	

Item name	Meaning	Value changes	Format	Data size [bytes]
VLAACK	Variable Limit Attribute Acknowledge Code	Not allowed.	B	1

- \*1. The U8 format specified in the SECS/GEM standard is not supported.
- \*2. The list format specified in the SECS/GEM standard is not supported.
- \*3. The JIS-8 format specified in the SECS/GEM standard is not supported.
- \*4. The I8 format specified in the SECS/GEM standard is not supported.
- \*5. With remote control, you can specify a different format for each variable.
- \*6. With the data definitions, you can specify a different format for each variable.
- \*7. With process program management, you can specify a different format for each variable.

## 5-4 Variable Data Definitions

Variable data indicates the settings for the host connection function and the operating status. You can check the contents of variable data with **Data Definition** on the Tools Menu of the SECS/GEM Configurator.

### 5-4-1 Types of Variable Data

The following table lists the three types of variable data.

Variable data	Meaning	Maximum number registered
Equipment constants (EC)	These variables are changed by the host.	512*1
Status variables (SV)	These variables always hold valid information. They cannot be changed from the host.	---*1
Discrete variables (DV)	These variables are valid only when specific events occur.	---*1

\*1. You can register a total of 1,024 equipment constants (EC), status variables (SV), and discrete variables (DV).

There are also two types of variable data depending on who defines the variables: standard variables and user-defined variables.

Definition	Meaning
Standard variables	These variables are defined by the host connection function as standard features.
User-defined variables	You define the formats and data sizes on the SECS/GEM Configurator.

### 5-4-2 Link Variables for Variable Data

Link variables for standard variable data are registered as system-defined variables. You use the SECS/GEM Configurator to assign link variables of the correct data type for the format to user-defined variable data.

The specifications for link variable attributes and initialization are described in the following table.

Variable data		Link variable		
Type	Definition	Attributes		Initialization
		Retain	Constant	
Equipment constants	Standard variables	Yes	Yes	<ul style="list-style-type: none"> <li>The variables are initialized when the GEM Services are started after the variables are transferred from the SECS/GEM Configurator.</li> <li>To initialize the variables while the host connection function is operating, execute the Change Equipment Constant (GEM_ChangeECV) instruction while the GEM Service status is EQinitializing.</li> </ul>
	User-defined variables			
Status variables	Standard variables	No	*1	The system-defined status variables that have a Constant attribute are initialized by the GEM Services. You must initialize the other variables in the user program at startup.
	User-defined variables		No	
Discrete variables	Standard variables	No	No	You must initialize these variables in the user program as required.
	User-defined variables			

\*1. This depends on the variable data.

### 5-4-3 List Specifications for Variable Data

You can define lists in the format for a user-defined status variable or discrete variable. There are two types of lists: lists of fixed length data and lists of length-variable data. Also, you can nest lists. You can nest lists within lists. You can create a total of up to three nesting levels for lists of fixed length data and lists of length-variable data. You cannot nest a list of length-variable data inside a list of length-variable data.

The specifications of list structures are given in the following table.

Item	Specification
Maximum number of list structures that can be defined	64
Maximum number of items registered in one list structure	64
Maximum size of variable data in a list structure [Kbytes]	2

#### Lists of Fixed Length Data

For a list of fixed length data, you set the items for each list. *Number of lists* indicates the number of items in the level that is directly below a list structure level. For example, if the structure of a level that is a list of fixed length data is <L,4>, there are four items in the level that is immediately below it, so the number of lists is given as 4. You can set a different format for each item in a list. The specifications for a list of fixed length data are given in the following table.

Item	Specification
Number of lists	0 to 64

In a list of fixed length data, a link variable is assigned to store the value separately for each item in the list.

The following example shows a variable data structure on the SECS/GEM Configurator for a list of fixed length data with three nesting levels and a link variable assigned for each item.

Variable data structure

L,4

- 1.B Item1
- 2.U1 Item2
- 3.U2 Item3
- 4.L,2
  - 1.B Item4
  - 2.L,2
    - 1.I1 Item5
    - 2.I2 Item6

Structure	Link variable
4	
1.<B Item1>	VIDn_Item1
2.<U1 Item2>	VIDn_Item2
3.<U2 Item3>	VIDn_Item3
4.L,2	
1.<B Item4>	VIDn_Item4
2.L,2	
1.<I1 Item5>	VIDn_Item5
2.<I2 Item6>	VIDn_Item6

Number of lists

Item name

Link variable assigned to item

## Lists of Length-variable Data

For the list of length-variable data, you set items to be changeable. All items in the list have the same format. The specifications for a list of length-variable data are given in the following table.

Item	Specification
Number of lists	1 to 64

For a list of length-variable data, a link variable to store the number of items and a shared array link variable to store the item values are assigned. The number of array elements must be equal to the maximum number of items.

The following example shows an example on the SECS/GEM Configurator for variable data items in a list of length-variable data and link variable assignments. The variable *VIDm\_List1* stores the number of items in the list of length-variable data, and the variable *VIDm\_Item1* stores the values of the items. The data type of *VIDm\_Item1* is *ARRAY[0..4] OF INT*.

The data type is *ARRAY[0..4] OF INT*.

Variable data structure  
 L,n (Max. value of n: 5)  
 1.I2 Item1  
 2.I2 Item2  
 :  
 n.I2 Itemn

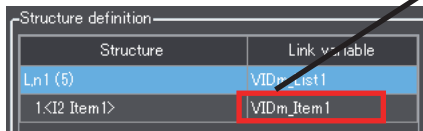

### 5-4-4 Standard Variable Data

The names, meanings, formats, and data sizes of the standard variable data are given in the following tables along with whether the values can be changed.

The data size is given in the *Data size* column only when it is not implicit from the format.

Refer to *A-3 Correspondence between Formats and Data Types* on page A-230 for the format codes and meanings, and the corresponding data types handled by the NJ-series CPU Units.

#### Equipment Constant (EC) Definitions

The names, meanings, and formats of the standard variable data are given in the following table along with whether the values can be changed from the SECS/GEM Configurator.

Equipment constant name	Meaning	Value changes	Format
EnableSpooling	Enable/Disable spooling	Not allowed.	BOOLEAN
EstablishCommunicationsTimeout	The interval between attempts to send S1F13 when establishing communications	Not allowed.	U2
MaxSpoolTransmit	The maximum number of messages to be sent from the spool	Not allowed.	U4
OverWriteSpool	Indicates whether to overwrite data or to stop spooling whenever the spool area limits are exceeded.	Not allowed.	BOOLEAN
TimeFormat	Time format	Allowed.	U1, U2, U4

#### Status Variable (SV) Definitions

The names, meanings, formats, and data sizes of the standard status variable data are given in the following table along with whether the values can be changed from the SECS/GEM Configurator.

Status variable name	Meaning	Value changes	Format	Data size [bytes]
AlarmsEnabled	The list of alarms (ALIDs) enabled for reporting	Not allowed.	Same as format of ALID.	
AlarmsSet	The list of alarms (ALIDs) currently occur	Not allowed.	Same as format of ALID.	
CLOCK	Present clock time	Not allowed.	A	12 or 16 <sup>*1</sup>
ControlState	The current control state of the equipment	Not allowed.	U1	
EventsEnabled	The list of events (CEIDs) enabled for reporting	Not allowed.	Same as format of CEID.	
PPExecName	The PPID(s) of the currently selected Process Program(s).	Not allowed.	Same as format of PPID.	
PPFormat	The type(s) of supported process programs	Not allowed.	U1	
ProcessState	The current processing state of the equipment	Not allowed.	U1	
PreviousProcessState	The previous processing state of the equipment	Not allowed.	U1	
SpoolCountActual	A count of the messages actually contained in the spool area	Allowed.	U1, U2, or U4	



Status variable name	Meaning	Value changes	Format	Data size [bytes]
SpoolCountTotal	The total number of messages that can be saved in the spool area	Allowed.	U1, U2, or U4*2	
SpoolFullTime	The timestamp from the time the spool last became full	Not allowed.	A	12 or 16*1
SpoolStartTime	The timestamp from the time spooling last became active	Not allowed.	A	12 or 16*1

\*1. The data length is determined by the value of the *TimeFormat* equipment constant.

\*2. The total number of messages that can be saved in the spool area depends on the format. If the format is U1, 255 messages can be saved. If the format is U2 or U4, 1,000 messages can be saved.

## Discrete Variable (DV) Definitions

The names, meanings, formats, and data sizes of the standard discrete variable data are given in the following table along with whether the values can be changed from the SECS/GEM Configurator.

Discrete variable name	Meaning	Value changes	Format
AlarmID	The current alarm identification	Not allowed.	Same as format of ALID.
EventLimit	A list of LIMITIDs whose limits are reached or crossed	Not allowed.	Same as format of LIMITID.
LimitVariable	The VID for the variable whose value exceeded limit monitoring zones	Not allowed.	Same as format of VID.
OperatorCommand	A command issued by the operator	Allowed.	U1, U2, or U4
PPChangeName	The PPID which was affected by a creation, editing, or deletion of a Process Program by an operator	Not allowed.	Same as format of PPID.
PPChangeStatus	The action taken on the Process Program	Not allowed.	U1
TransitionType	The direction of the zone transition which has occurred	Not allowed.	B

## 5-5 GEM Capabilities

---

The GEM capabilities achieve functions specified in the SECS/GEM standards. Except for the automatic processing that is performed by the host connection function, you must use GEM instructions to intentionally perform processing to achieve GEM capabilities. Some GEM capabilities require that you set items on the SECS/GEM Configurator.

The following functions are implemented in the SECS/GEM CPU Unit to achieve GEM capabilities.

- Communications State Model
- Control State Model
- Equipment Processing States
- Event Notification
- Error Messages
- Documentation
- Dynamic Event Report Configuration
- Variable Data Collection
- Trace Data Collection
- Status Data Collection
- Alarm Management
- Host Commands
- Enhanced Remote Commands
- Equipment Constants
- Process Program Management
- Material Movement
- Equipment Terminal Services
- Clock
- Limit Monitoring
- Spooling

### 5-5-1 Communications State Model

The communications state model is based on the Host-Initiated S1,F13/F14 Scenario fundamental GEM requirement and on the Establish Communications additional GEM capability.

The design items required to achieve this function are given in the following table along with references.

Item	Requirement	Reference
Settings on the SECS/GEM Configurator	Required.	8-10-1 Communications State Model on page 8-58
Creating the user program on the Sysmac Studio	Required.	This section

### Communications State Model

The GEM Service communications states operate according to the following communications state model. The host connection function manages state transitions in the communications state model. You do not need to manage state transitions for the communications state model.

State transitions in the communications state model occur when the GEM Service status is EQRun. If the GEM Service status is not EQRun, the communications model state is always DISABLED.

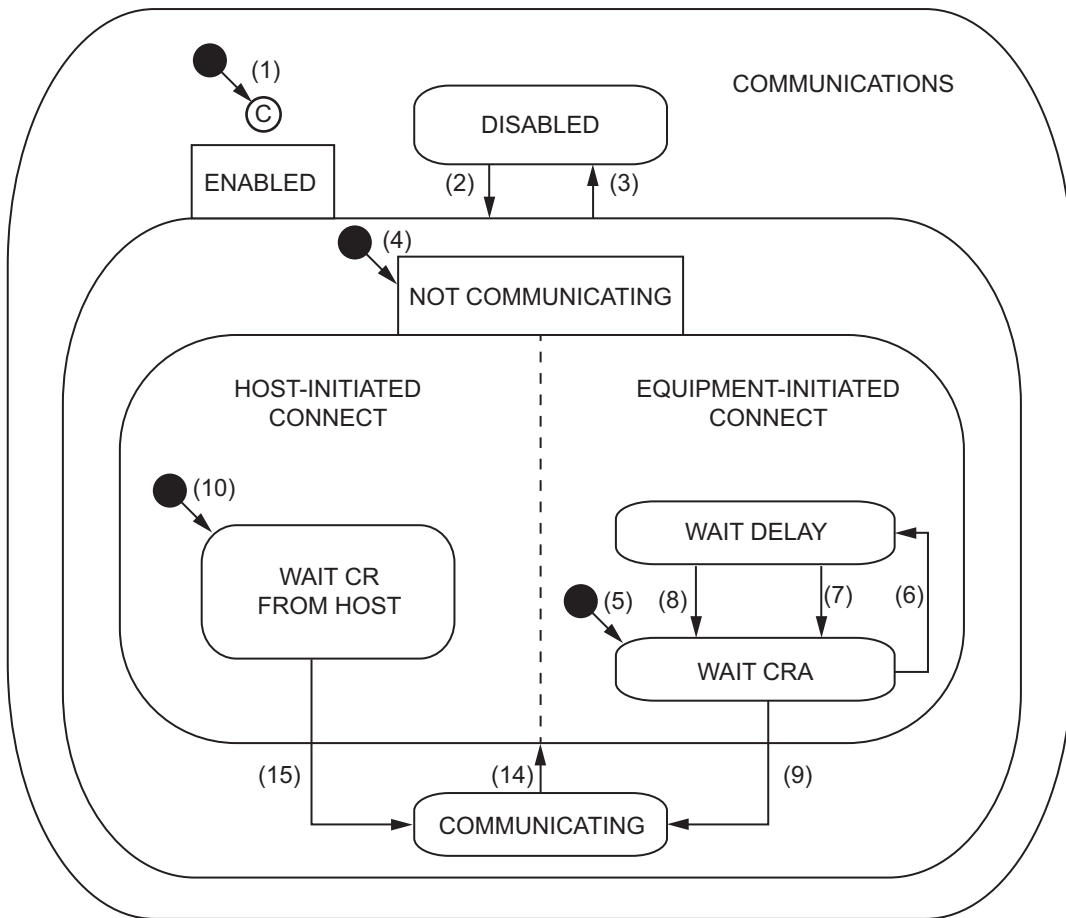

The triggers, resulting equipment operation, and comments for the above transitions are described in the following table. The numbers in the table correspond to the numbers in the figure.

No.	Current state	Trigger	New state	Operation	Comment
(1)	(Entry to COMMUNICATIONS)	The GEM Service state changes to EQRun.	Default*1	None	---
(2)	DISABLED	The Change Communications State (GEM_ChangeCommState) instruction is executed and the communications state changes to ENABLED.	ENABLED	None	SECS-II communications are enabled.
(3)	ENABLED	<ul style="list-style-type: none"> <li>The Change Communications State (GEM_ChangeCommState) instruction is executed and the communications state changes to DISABLED.</li> <li>The GEM Service state changes to a state other than EQRun.</li> </ul>	DISABLED	None	SECS-II communications are prohibited.
(4)	(Entry to ENABLED)	Any entry to ENABLED state.	NOT COMMUNICATING	None	---
(5)	(Entry to EQUIPMENT-INITIATED CONNECT)	Any entry to NOT COMMUNICATING	WAIT CRA	Initialize communications. Set CommDelay timer to expired state. Send Establish Communications Request (S1,F13).	Begin an attempt to establish communications.
(6)	WAIT CRA	Connection transaction failure.	WAIT DELAY	Initialize CommDelay timer. Dequeue all SECS messages that were queued to send.	If appropriate, place dequeued messages in spool buffer in the order they were generated. Wait for timer to expire.
(7)	WAIT DELAY	CommDelay timer expired.	WAIT CRA	Send Establish Communications Request (S1,F13) and wait for Establish Communications Request Acknowledge (S1,F14).	Establish Communications Request (S1,F13) may be received from host.
(8)	WAIT DELAY	A SECS message other than Establish Communications Request (S1,F13) was received.	WAIT CRA	Discard the SECS message. No reply. Set CommDelay timer to expired state. Send Establish Communications Request (S1,F13).	---

No.	Current state	Trigger	New state	Operation	Comment
(9)	WAIT CRA	Establish Communications Request Acknowledge (S1,F14) was received with COMMACK = 0.	COMMUNICATING	None	Communications are established.
(10)	---	Any entry to NOT COMMUNICATING	WAIT CR FROM HOST	None	Wait for Establish Communications Request (S1,F13) from host.
(14)	COMMUNICATING	Communications failure	NOT COMMUNICATING	Dequeue all SECS messages that were queued to send.	Place dequeued SECS messages in spool buffer as appropriate.
(15)	WAIT CR FROM HOST	Establish Communications Request (S1,F13) was received.	COMMUNICATING	Send Establish Communications Request Acknowledge (S1,F14) with COMMACK = 0.	Communications are established.

\*1. The default is controlled by the setting made with **Model Settings - Communications State Model - Default Communications state** from the List Menu of the SECS/GEM Configurator.

## Communications State Model Scenarios

There are the following two Communications State Model scenarios.

- Host Attempts to Establish Communications
- Equipment Attempts to Establish Communications and Host Acknowledges

### ● Host Attempts to Establish Communications

The following procedure is used for the Host Attempts to Establish Communications scenario.

- 1** The host sends Establish Communications Request (S1,F13).
- 2** The host connection function determines if the received primary message is normal.

The normal/error results and factors, and the host connection function processing for each, are given in the following table. The table also tells if the user program is notified.

Result	Factor	Host connection function processing		Notification
		Processing	Value of ACKC5	
Normal	---	Send Establish Communications Request Acknowledge (S1,F14) to the host.	0	None
Error	The communications state model state is not ENABLED.	Common processing	1	
	Common criteria*1	---	---	

\*1. Refer to *When Host Sends the Primary Message* on page 5-7 for the common criteria and applicable processing.

### ● Equipment Attempts to Establish Communications and Host Acknowledges

The following procedure is used for the Equipment Attempts to Establish Communications and Host Acknowledges scenario.

- 1** To change the communications state to ENABLED, the Change Communications State (GEM\_ChangeCommState) instruction is executed in the user program.  
To change the communications state to ENABLED, the value of the *TransitionEvent* input variable to the GEM\_ChangeCommState instruction is set to `_GEM_COMM_ENABLED`.
- 2** The host connection function sends Establish Communications Request (S1,F13).
- 3** The host sends Establish Communications Request Acknowledge (S1,F14).

## Initial Settings for the Communications State Model

Initial settings are necessary for the communications state model. Initial settings can be made from the SECS/GEM Configurator or from the user program.

### ● Initial Settings with the SECS/GEM Configurator

Refer to *8-10-1 Communications State Model* on page 8-58 for the procedures to make the initial settings for the communications state model on the SECS/GEM Configurator.

### ● Initial Settings from the User Program

You can make the initial settings for the communications state model from the user program. The setting methods and update timing for each setting item are given in the following table.

Item	Setting method	Update timing
Establish Communications Timeout	Use the Change Equipment Constant (GEM_ChangeECV) instruction to set the value of the Establish Communications Timeout ( <code>_GEM_EstablishCommunicationsTimeout</code> ) system-defined variable.	When the GEM Service status changes to EQRun
Default Communications State	Set the value of the Default Communications State ( <code>_GEM_DefaultCommunicationState</code> ) system-defined variable.	
Equipment Model Type	Set the value of the Equipment Model Type ( <code>_GEM_EquipInfo.MDLN</code> ) system-defined variable.	
Software Revision Code	Set the value of the Software Revision Code ( <code>_GEM_EquipInfo.SOFTREV</code> ) system-defined variable.	

## Checking the State of the Communications State Model

Use the following system-defined variable to check the state of the communications state model. Refer to *A-2 System-defined Variables* on page A-211 for details on system-defined variables.

System-defined variable	Name
<code>_GEM_CommunicationsState</code>	Communications State

### 5-5-2 Control State Model

The control state model is based on the State Models, On-line Identification, and Control (Operator-Initiated) fundamental GEM requirements. It is also based on the Control (Host-initiated) additional GEM capability.

The design items required to achieve this function are given in the following table along with references.

Item	Requirement	Reference
Settings on the SECS/GEM Configurator	Required.	8-10-2 Control State Model on page 8-59
Creating the user program on the Sysmac Studio	Required.	This section

### Control State Model

The GEM Service control states operate according to the following control state model. The host connection function manages state transitions in the control state model. You do not need to manage state transitions for the control state model.

State transitions in the control state model occur when the GEM Service status is EQRun. If the GEM Service status is not EQRun, the control model state is always EQUIPMENT OFF-LINE.

When the control state changes, the host connection function issues a collection event.

The current control state is given in the Control State (`_GEM_ControlState`) system-defined variable.

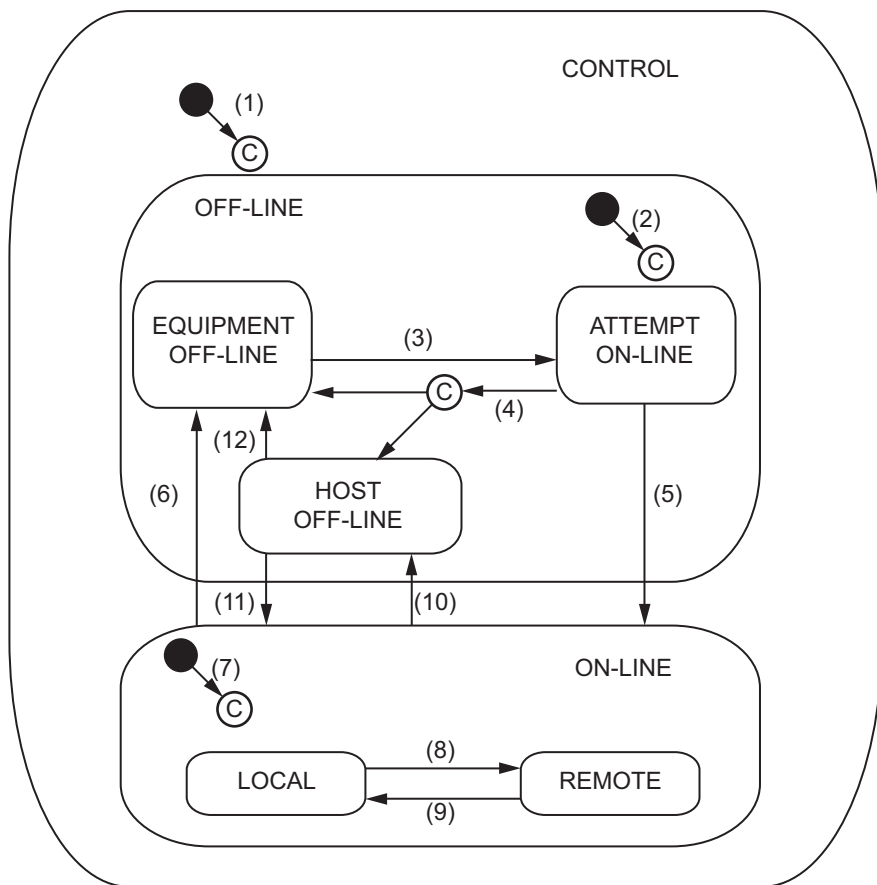

The triggers, resulting equipment operation, and comments for the above transitions are described in the following table. The numbers in the table correspond to the numbers in the figure.

No.	Current state	Trigger	New state	Operation	Comment
(1)	(Undefined)	The GEM Service status changed to EQRun.	CONTROL* <sup>1</sup>	None	---
(2)	(Undefined)	Entry into OFF-LINE state. * <sup>2</sup>	OFF-LINE* <sup>1</sup>	None	---
(3)	EQUIPMENT OFF-LINE	Equipment changed to ON-LINE. The Change Control State (GEM_ChangeControlState) instruction was executed with ON-LINE/LOCAL or ON-LINE/REMOTE specified for the transition request.	ATTEMPT ON-LINE	None	---
(4)	ATTEMPT ON-LINE	<ul style="list-style-type: none"> <li>• Abort Transaction (S1,F0) was received.</li> <li>• Communications timeout occurs.</li> <li>• Communications fail.</li> </ul>	EQUIPMENT OFF-LINE or HOST OFF-LINE* <sup>3</sup>	None	---
(5)	ATTEMPT ON-LINE	On-Line Data (S1,F2) was received from the host.	ON-LINE* <sup>4</sup>	None	---
(6)	ON-LINE	Equipment changed to OFF-LINE. The Change Control State (GEM_ChangeControlState) instruction was executed with OFF-LINE specified for the transition request.	EQUIPMENT OFF-LINE	None	An Equipment OFF-LINE collection event occurs.
(7)	(Undefined)	Entry into ON-LINE state. * <sup>5</sup>	ON-LINE* <sup>6</sup>	None	A Control State LOCAL or Control State REMOTE collection event occurs.
(8)	LOCAL	The operator set the front panel switch to REMOTE. The Change Control State (GEM_ChangeControlState) instruction was executed with ON-LINE/REMOTE specified for the transition request.	REMOTE	None	A Control State REMOTE collection event occurs.
(9)	REMOTE	The operator set the front panel switch to LOCAL. The Change Control State (GEM_ChangeControlState) instruction was executed with ON-LINE/LOCAL specified for the transition request.	LOCAL	None	A Control State LOCAL collection event occurs.
(10)	ON-LINE	Request OFF-LINE (S1,F15) was received from the host.	HOST OFF-LINE	None	An Equipment OFF-LINE collection event occurs.
(11)	HOST OFF-LINE	Request ON-LINE (S1,F17) is received from the host.	ON-LINE* <sup>6</sup>	None	If an interlock is set, ON-LINE Acknowledge (S1,F18) is sent with ONLACK (deny). In that case, the state does not change.



No.	Current state	Trigger	New state	Operation	Comment
(12)	HOST OFF-LINE	Equipment changed to OFF-LINE. The Change Control State (GEM_ChangeControlState) instruction was executed with OFF-LINE specified for the transition request.	EQUIPMENT OFF-LINE	None	An Equipment OFF-LINE collection event occurs.

- \*1. The substate is controlled by the setting made with **Model Settings - Control State Model - Default Control state** from the List Menu of the SECS/GEM Configurator.
- \*2. When the setting made with **Model Settings - Control State Model - Default Control state** from the List Menu of the SECS/GEM Configurator is one of the following: Equipment OFF-LINE, Attempt ON-LINE, or HOST OFF-LINE.
- \*3. The state after the transition is controlled by the setting made with **Model Settings - Control State Model - Failed Online state** from the List Menu of the SECS/GEM Configurator.
- \*4. The substate is controlled by the specification in the Change Control State (GEM\_ChangeControlState) instruction. The state when operation starts is controlled by the setting made with **Model Settings - Control State Model - Default Online substate** from the List Menu of the SECS/GEM Configurator.
- \*5. When the setting made with **Model Settings - Control State Model - Default Control state** from the List Menu of the SECS/GEM Configurator is ON-LINE.
- \*6. The substate is controlled by the setting made with **Model Settings - Control state Model - Default Online substate** from the List Menu of the SECS/GEM Configurator.

## Control State Model Scenarios

There are the following four Control State Model scenarios.

- On-line Identification
- Control (Operator-initiated)
- Control (Host-initiated) - Request ON-LINE
- Control (Host-initiated) - Request OFF-LINE

### ● On-line Identification

The following procedure is used for the On-Line Identification scenario.

**1** The host sends Are You There Request (S1,F1).

**2** The host connection function determines if the received primary message is normal.

The normal/error results and factors, and the host connection function processing for each, are given in the following table. The table also tells if the user program is notified.

Result	Factor	Host connection function processing	Notification
Normal	The control state is ON-LINE.	Sends On-Line Data (S1,F2) to the host.	None
Error	Common criteria*1	Common processing	

\*1. Refer to *When Host Sends the Primary Message* on page 5-7 for the common criteria and applicable processing.

**3** The host connection function returns On-Line Data (S1,F2).

### ● Control (Operator-initiated)

The following procedure is used for the Control (Operator-initiated) scenario.

- 1** To change the equipment control state, execute the GEM Service Control (GEM\_ControlService) instruction in the user program.
- 2** The host connection function changes the control state.  
For an online request, the host connection function sends Are You There Request (S1,F1). In response, the host sends On-Line Data (S1,F2).

### ● Control (Host-initiated) - Request ON-LINE

The following procedure is used for the Control (Host-initiated) - Request ON-LINE scenario.

- 1** The host sends Request ON-LINE (S1,F17).
- 2** The host connection function determines if the received primary message is normal.  
The normal/error results and factors, and the host connection function processing for each, are given in the following table. The table also tells if the user program is notified.

Result	Factor	Host connection function processing		Notification
		Processing	Value of ONLACK	
Normal	---	Sends ON-LINE Acknowledge (S1,F18) to the host.	0	None
Error	<ul style="list-style-type: none"> <li>• The control state is HOST OFF-LINE.</li> <li>• The value of the <code>_GEM_Interlock_ControlState</code> interlock variable is TRUE.</li> </ul>		1	
	The control state is already ON-LINE.		2	
	Common criteria <sup>*1</sup>		Common processing	

\*1. Refer to *When Host Sends the Primary Message* on page 5-7 for the common criteria and applicable processing.

- 3** The host connection function returns ON-LINE Acknowledge (S1,F18).

● **Control (Host-initiated) - Request OFF-LINE**

The following procedure is used for the Control (Host-initiated) - Request OFF-LINE scenario.

- 1** The host sends Request OFF-LINE (S1,F15).
- 2** The host connection function determines if the received primary message is normal.  
The normal/error results and factors, and the host connection function processing for each, are given in the following table. The table also tells if the user program is notified.

Result	Factor	Host connection function processing		Notifica-tion
		Processing	Value of OFLACK	
Normal	---	Sends OFF-LINE Acknowledge (S1,F16) to the host.	0	None
Error	Common criteria*1	Common processing	---	

\*1. Refer to *When Host Sends the Primary Message* on page 5-7 for the common criteria and applicable processing.

- 3** The host connection function returns OFF-LINE Acknowledge (S1,F16).

**\_GEM\_Interlock\_ControlState Interlock Variable**

The \_GEM\_Interlock\_ControlState interlock variable is related to the control state model.

The relationship between the control state model scenarios and the SECS messages that are interlocked is given in the following table.

Scenario	Interlocked SECS message
On-line Identification	None
Control (Operator-initiated)	Request ON-LINE (S1,F17)
Control (Host-initiated)	None

## Initial Settings for the Control State Model

Initial settings are necessary for the control state model. Initial settings can be made from the SECS/GEM Configurator or from the user program.

### ● Initial Settings with the SECS/GEM Configurator

Refer to *8-10-2 Control State Model* on page 8-59 for the procedures to make the initial settings for the control state model on the SECS/GEM Configurator.

### ● Initial Settings from the User Program

You can make the initial settings for the control state model from the user program. The setting method for each setting item is given in the following table.

Item	Setting method
Default Control State	Set the value of the Default Control State ( <code>_GEM_ControlStateParam.DefaultControl</code> ) system-defined variable.
Default ON-LINE Substate	Set the value of the Default Online Substate ( <code>_GEM_ControlStateParam.DefaultOnlineSubState</code> ) system-defined variable.
ON-LINE Failure State	Set the value of the ON-LINE Failure State ( <code>_GEM_ControlStateParam.ChangeOnlineFailed</code> ) system-defined variable.

## Checking the State of the Control State Model

Use the following system-defined variable to check the state of the control state model. Refer to *A-2 System-defined Variables* on page A-211 for details on system-defined variables.

System-defined variable	Name
<code>_GEM_ControlState</code>	Control State

### 5-5-3 Equipment Processing States

The equipment processing states are based on the Equipment Processing States fundamental GEM requirement.

The design items required to achieve this function are given in the following table along with references.

Item	Requirement	Reference
Settings on the SECS/GEM Configurator	Required.	5-5-4 <i>Event Notification</i> on page
Creating the user program on the Sysmac Studio	Required.	5-40

### Equipment Processing States

The equipment-specified processing states are managed in the user program.

When the processing state changes, the equipment must report a collection event to the host. To do so, the CEID of each collection event is specified and the Report Event (GEM\_ReportEvent) instruction is executed in the user program.

The status variables and link variables that are related to collection events are described in the following table. You must set the link variables before you execute the GEM\_ReportEvent instruction.

Collection event	Status variable	Link variable	Meaning
Processing Started	PreviousProcessState	_GEM_PreviousProcessState	The equipment processing state before the most recent change in the equipment processing state
Processing Completed			
Processing Stopped			
Processing State Change	ProcessState	_GEM_ProcessState	The current equipment processing state

### Equipment Processing State Model

The equipment processing state model is determined by the user according to the equipment process and style. A typical equipment processing state model is shown in the following figure.

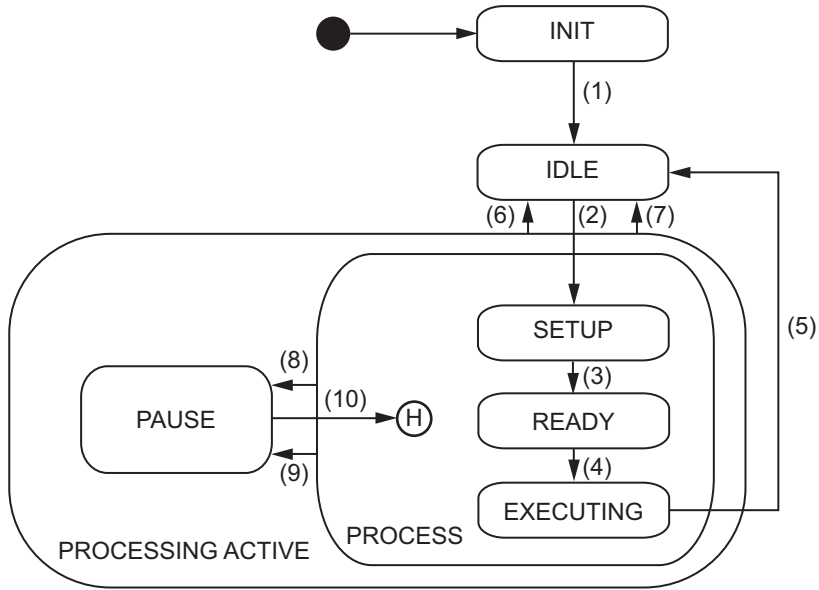

The triggers, resulting equipment operation, and comments for the above transitions are described in the following table. The numbers in the table correspond to the numbers in the figure.

No.	Current state	Trigger	New state	Operation	Comment
(1)	INIT	Initialization is completed.	IDLE	None	A Processing State Change collection event is issued.
(2)	IDLE	Setup command	SETUP	None	A Processing State Change collection event is issued.
(3)	SETUP	Setup is completed.	READY	Depends on the equipment.	A Processing State Change collection event is issued.
(4)	READY	Start command	EXECUTING	Depends on the equipment.	Processing State Change and Processing Started collection events are issued.
(5)	EXECUTING	Task is completed.	IDLE	None	Processing State Change and Processing Completed collection events are issued.
(6)	PROCESSING ACTIVE	Stop command	IDLE	None	A Processing State Change collection event is issued.
(7)	PROCESSING ACTIVE	Abort command	IDLE	Depends on the equipment.	A Processing State Change collection event is issued.
(8)	PROCESS	Pause state	PAUSE	Depends on the equipment.	A Processing State Change collection event is issued.
(9)	PROCESS	Pause command	PAUSE	Depends on the equipment.	Processing State Change and Processing Stopped collection events are issued.
(10)	PAUSE	Resume command	Previous PROCESS substate	Depends on the equipment.	A Processing State Change collection event is issued.

### 5-5-4 Event Notification

Event notification is based on the Event Notification fundamental GEM requirement.

The design items required to achieve this function are given in the following table along with references.

Item	Requirement	Reference
Settings on the SECS/GEM Configurator	Required.	8-11-1 <i>Event Notification</i> on page 8-61
Creating the user program on the Sysmac Studio	Required.	This section

## Event Notification

When an equipment collection event is issued, a collection event can be issued based on the Event Notification fundamental GEM requirement.

For each collection event, the linked report and the report members (equipment constants, status variables, and discrete variables) are set in advance in the event definitions of the SECS/GEM Configurator. If a user-defined variable is used as a report member variable, it is set in the data definitions of the SECS/GEM Configurator.

Collection events include events that are issued with the Report Event (GEM\_ReportEvent) instruction and events that are issued automatically by the host connection function.

The specifications of event notification are given in the following table.

Item	Specification
Maximum number of registered events	256 <sup>*1</sup>
Maximum number of reports linked to events	32
Maximum number of registered reports	128
Maximum number of variables that you can link to reports <sup>*2</sup>	64

\*1. Excluding collection events registered for alarms.

\*2. These variables include equipment constants, status variables, and discrete variables.

Multi-block Data Send Inquire (S6,F5) and Multi-block Grant (S6,F6) are not supported.



## Standard Collection Events

The following collection events are registered as standard features on the SECS/GEM Configurator. The collection event ECIDs, report variable data, and issuing method are given.

Type	Collection event	ECID	Report variable data	Issuing method
Control-related events	Equipment OFF-LINE	1	ControlState, CLOCK	Automatic
	Control State LOCAL	2	ControlState, CLOCK	Automatic
	Control State REMOTE	3	ControlState, CLOCK	Automatic
	Operator Command Issued	4	OperatorCommand	Instruction
Process-ing-related events	Processing Started	5	CLOCK, PreviousProcessState	Instruction
	Processing Completed	6	CLOCK, PreviousProcessState	Instruction
	Processing Stopped	7	CLOCK, PreviousProcessState	Instruction
	Processing State Change	8	CLOCK, ProcessState, PreviousProcessState	Instruction
Equipment constants	Operator Equipment Constant Change* <sup>1</sup>	9	---	Instruction
Alarm management events	Alarm <sub>n</sub> Detected	*2	CLOCK, AlarmID, AlarmSet	Automatic
	Alarm <sub>n</sub> Cleared	*2	CLOCK, AlarmID, AlarmSet	Automatic
Limits monitoring events	Limit Zone Transition	*3	CLOCK, LimitVariable, EventLimit, TransitionType	Automatic
Process program management events	Process Program Change	10	PPChangeName, PPChangeStatus	Instruction
	Process Program Selected	11	PPExecName	Instruction
Material movement events	Material Received	12	CLOCK	Instruction
	Material Removed	13	CLOCK	Instruction
Spooling-related events	Spooling Activated	14	SpoolStartTime	Automatic
	Spooling Deactivated	15	SpoolCountTotal	Automatic
	Spool Transmit Failure	16	CLOCK, SpoolCountActual, Spool-CountTotal	Automatic
Equipment terminal service events	Message Recognition	17	CLOCK	Instruction

\*1. Refer to *8-11-1 Event Notification* on page 8-61 for the setting procedure for the Operator Equipment Constant Change report variable data.

\*2. An alarm management collection event is created for each ALID when an alarm is registered.

\*3. A limit monitoring collection event is created for each status variable when you specify limit monitoring in the status variable definitions.

## Event Notification Scenarios

There are the following two Event Notification scenarios.

- Collection Event Occurs on Equipment
- Host Responds Event Report

### ● Collection Event Occurs on Equipment

The following procedure is used for the Collection Event Occurs on Equipment scenario.

- 1** The host connection function sends Event Report Send (S6,F11).  
To send Event Report Send (S6,F11), execute the Report Event (GEM\_ReportEvent) instruction in the user program.
- 2** The host sends Event Report Acknowledge (S6,F12).



#### Precautions for Correct Use

The Event Report Send (S6,F11) SECS message is not sent if the maximum message length of 256 Kbytes is exceeded. Also, a Too Long SECS Message event (event code 66020000 hex) is registered. The GEM\_ReportEvent instruction, however, ends normally.

### ● Host Responds Event Report

The following procedure is used for the Host Responds Event Report scenario.

- 1** The host sends Event Report Request (S6,F15).
- 2** The host connection function determines if the received primary message is normal.  
The normal/error results and factors, and the host connection function processing for each, are given in the following table. The table also tells if the user program is notified.

Result	Factor	Host connection function processing	Notification
Normal	---	Sends Event Report Data (S6,F16) to the host.	None
Error	Common criteria*1	Common processing	

\*1. Refer to *When Host Sends the Primary Message* on page 5-7 for the common criteria and applicable processing.

- 3** The host connection function returns Event Report Data (S6,F16).



#### Precautions for Correct Use

Only the header of the Event Report Data (S6,F16) SECS message is sent if the maximum message length of 256 Kbytes is exceeded. Also, a Too Long SECS Message event (event code 66020000 hex) is registered.

To prevent exceeding the maximum message length, make sure that the total size of all reports linked to an event is 254 Kbytes or less when you set up event notification on the SECS/GEM Configurator.

## 5-5-5 Error Messages

Error messages are based on the Error Messages fundamental GEM requirement.

The design items required to achieve this function are given in the following table along with references.

Item	Requirement	Reference
Settings on the SECS/GEM Configurator	Not required.	---
Creating the user program on the Sysmac Studio	Not required.	

### Error Messages

The equipment reports information on the causes of errors found in SECS messages and communications with the host based on the Error Messages fundamental GEM requirement.

Errors in SECS messages and communications are detected by the host connection function and it sends an S9 message for the relevant error type to the host. Therefore, it is not necessary to create any user programming.

The contents of the S9 messages are given in the following table.

Stream and function numbers	Function name
S9,F1	Unrecognized Device ID
S9,F3	Unrecognized Stream Type
S9,F5	Unrecognized Function Type
S9,F7	Illegal Data
S9,F9	Transaction Timer Timeout
S9,F11	Data Too Long
S9,F13	Conversation Timeout

The following restrictions exist for errors related to Process Program Load Inquire (S7,F1).

- The value of EDID in Conversation Timeout (S9,F13) is the value of PPID from Process Program Load Inquire (S7,F1) for which an error was detected.
- Monitoring for conversation timeouts is performed until Process Program Load Inquire (S7,F1) or Formatted Process Program Send (S7,F23) is received.
- If the next Process Program Load Inquire (S7,F1) is received while monitoring for conversation timeouts for a previous Process Program Load Inquire (S7,F1), conversation timeout monitoring is canceled for the previous Process Program Load Inquire (S7,F1) and started for the next one.

### Checking for Error Messages

To check for error messages, you can use the S9 Errors (`_GEM_S9Error`) system-defined variable or the SECS message log.

#### ● Checking with the `_GEM_S9Error` System-defined Variable

You can check for the number of each S9 message with `_GEM_S9Error`. Refer to A-2 System-defined Variables on page A-211 for details on `_GEM_S9Error`.

#### ● Checking with the SECS Message Log

You can check S9 messages in the SECS message log. Refer to 6-2-2 Displaying the Contents of the GEM Service Logs on page 6-4 for details on the SEC message log.

### 5-5-6 Documentation

Documentation is based on the Documentation fundamental GEM requirement.

The design items required to achieve this function are given in the following table along with references.

Item	Requirement	Reference
Settings on the SECS/GEM Configurator	Not required.	---
Creating the user program on the Sysmac Studio	Not required.	

### Documentation

You can create lists of the following information required for the Documentation fundamental GEM requirement.

- Items
- Messages
- Collection events
- Reports
- Alarms
- Equipment constants, status variables, and discrete variables

Refer to *8-4-5 Documentation* on page 8-30 for details on documentation.

## 5-5-7 Dynamic Event Report Configuration

The dynamic event report configuration is based on the Dynamic Event Report Configuration additional GEM capability.

The design items required to achieve this function are given in the following table along with references.

Item	Requirement	Reference
Settings on the SECS/GEM Configurator	Not required.	---
Creating the user program on the Sysmac Studio	Not required.	

### Dynamic Event Report Configuration

The host can dynamically correct or change the equipment event report configuration based on the Dynamic Event Report Configuration additional GEM capability.

The host connection function manages the dynamic event report configuration. You do not need to manage the dynamic event report configuration.

### Dynamic Event Report Configuration Scenario

There is the following one Dynamic Event Report Configuration scenario.

- Collection Event Reporting Set-up

The Collection Event Reporting Set-up can be divided into the following four types based on the SEC messages sent by the host.

- Collection Event Reporting Set-up - Define Report (S2,F33)
- Collection Event Reporting Set-up - Link Event Report (S2,F35)
- Collection Event Reporting Set-up - Enable/Disable Event Report (S2,F37)
- Collection Event Reporting Set-up - Multi-Block Inquire (S2,F39)



#### Precautions for Correct Use

When you change the settings for reports linked with Define Report (S2,F33) or Link Event Report (S2,F35), make sure that the total size of all linked reports is 245 Kbytes or less to prevent exceeding the maximum message length.

### ● Collection Event Reporting Set-up - Define Report (S2,F33)

The following procedure is used for the Collection Event Reporting Set-up - Define Report (S2,F33) scenario.

- 1** The host sends Define Report (S2,F33).
- 2** The host connection function determines if the received primary message is normal.

The normal/error results and factors, and the host connection function processing for each, are given in the following table. The table also tells if the user program is notified.

Result	Factor	Host connection function processing		Notification
		Processing	Value of DLACK	
Normal	---	Sends Define Report	0	None
Error	More than 64 VIDs are linked.	Acknowledge (S2,F34) to the host.	1	
	The same RPTID is used twice.		3	
	The VID is not registered.		4	
	Common criteria <sup>*1</sup>		Common processing	

\*1. Refer to *When Host Sends the Primary Message* on page 5-7 for the common criteria and applicable processing.

- 3** The host connection function returns Define Report Acknowledge (S2,F34).

### ● Collection Event Reporting Set-up - Link Event Report (S2,F35)

The following procedure is used for the Collection Event Reporting Set-up - Link Event Report (S2,F35) scenario.

- 1** The host sends Link Event Report (S2,F35).
- 2** The host connection function determines if the received primary message is normal.

The normal/error results and factors, and the host connection function processing for each, are given in the following table. The table also tells if the user program is notified.

Result	Factor	Host connection function processing		Notification
		Processing	Value of LRACK	
Normal	---	Sends Link Event	0	None
Error	More than 32 RPTIDs are linked.	Report Acknowledge (S2,F36) to the host.	1	
	A report was set for an event CEID that was already linked to a report. <sup>*1</sup>		3	
	The CEID is not registered.		4	
	The RPTID is not registered.		5	
	Common criteria <sup>*2</sup>		Common processing	

\*1. An error does not occur if the link event is deleted.

\*2. Refer to *When Host Sends the Primary Message* on page 5-7 for the common criteria and applicable processing.

- 3** The host connection function returns Link Event Report Acknowledge (S2,F36).

● **Collection Event Reporting Set-up - Enable/Disable Event Report (S2,F37)**

The following procedure is used for the Collection Event Reporting Set-up - Enable/Disable Event Report (S2,F37) scenario.

- 1** The host sends Enable/Disable Event Report (S2,F37).
- 2** The host connection function determines if the received primary message is normal.  
The normal/error results and factors, and the host connection function processing for each, are given in the following table. The table also tells if the user program is notified.

Result	Factor	Host connection function processing		Notification
		Processing	Value of ERACK	
Normal	---	Sends Enable/Disable Event Report Acknowledge (S2,F38) to the host.	0	None
Error	The CEID is not registered.		1	
	Common criteria <sup>*1</sup>	Common processing	---	

\*1. Refer to *When Host Sends the Primary Message* on page 5-7 for the common criteria and applicable processing.

- 3** The host connection function returns Enable/Disable Event Report Acknowledge (S2,F38).

● **Collection Event Reporting Set-up - Multi-Block Inquire (S2,F39)**

The following procedure is used for the Collection Event Reporting Set-up - Multi-Block Inquire (S2,F39) scenario.

- 1** The host sends Multi-Block Inquire (S2,F39).
- 2** The host connection function determines if the received primary message is normal.  
The normal/error results and factors, and the host connection function processing for each, are given in the following table. The table also tells if the user program is notified.

Result	Factor	Host connection function processing		Notification
		Processing	Value of GRANT	
Normal	---	Sends Multi-Block Grant (S2,F40) to the host.	0	None
Error	The message length exceeded 256 Kbytes.		2	
	Common criteria <sup>*1</sup>	Common processing	---	

\*1. Refer to *When Host Sends the Primary Message* on page 5-7 for the common criteria and applicable processing.

- 3** The host connection function returns Multi-Block Grant (S2,F40) according to the value of DATALENGTH.

## Dynamic Event Report Configuration Initialization

If the GEM Service status is EQinitializing and the Initialize Event (GEM\_InitEvent) instruction is executed, the dynamic event report configuration is initialized.

## 5-5-8 Variable Data Collection

Variable data collection is based on the Variable Data Collection additional GEM capability.

The design items required to achieve this function are given in the following table along with references.

Item	Requirement	Reference
Settings on the SECS/GEM Configurator	Not required.	---
Creating the user program on the Sysmac Studio	Not required.	

### Variable Data Collection

The host can ask for the values of equipment constants, status variables, and discrete variables based on the Variable Data Collection additional GEM capability.

The host connection function manages variable data collection. Therefore, it is not necessary to create any user programming.

### Variable Data Collection Scenario

The following procedure is used for variable data collection.

- 1** The host sends Individual Report Request (S6,F19).
- 2** The host connection function determines if the received primary message is normal.  
The normal/error results and factors, and the host connection function processing for each, are given in the following table. The table also tells if the user program is notified.

Result	Factor	Host connection function processing	Notifica- tion
Normal	---	Sends Individual Report Data (S6,F20) to the host.	None
Error	Common criteria <sup>*1</sup>	Common processing	

<sup>\*1</sup>. Refer to *When Host Sends the Primary Message* on page 5-7 for the common criteria and applicable processing.

- 3** The host connection function returns Individual Report Data (S6,F20).



## 5-5-9 Trace Data Collection

Trace data collection is based on the Trace Data Collection additional GEM capability.

The design items required to achieve this function are given in the following table along with references.

Item	Requirement	Reference
Settings on the SECS/GEM Configurator	Required.	8-9-3 <i>Status Variable (SV)</i> on page 8-50
Creating the user program on the Sysmac Studio	Not required.	---

### Trace Data Collection

The host can periodically sample the status variables based on the Trace Data Collection additional GEM capability. The host connection function manages trace data collection. You do not need to perform management for trace data collection.

The specifications of trace data collection are given in the following table.

Item	Specification
Maximum number of executable simultaneous traces	5
Maximum number of status variables for one trace	100
Maximum REPGSZ (reporting group size)	100
Data sample period, DSPER [s] <sup>*1</sup>	1 to 65535

\*1. The minimum unit is seconds. If you set the data sample period, DSPER, in milliseconds, all digits below seconds are truncated.

## Trace Data Collection Scenario

The following procedure is used for trace data collection.

- 1** The host sends Trace Initialize Send (S2,F23).
- 2** The host connection function determines if the received primary message is normal.  
The normal/error results and factors, and the host connection function processing for each, are given in the following table. The table also tells if the user program is notified.

Result	Factor	Host connection function processing		Notifi- cation
		Processing	Value of TIAACK	
Normal	---	Sends Trace Initialize Acknowledge (S2,F24) to the host.	0	None
Error	More than 100 status variables were specified.		1	
	Five traces are already being executed simultaneously.		2	
	The value of DSPER was not between 1 and 65,535 s.		3	
	An undefined status variable or a status variable that is not set for tracing was specified.		4	
	<ul style="list-style-type: none"> <li>• The value of REPGSZ was 0 or exceeded 100.</li> <li>• The value of REPGSZ was larger than TOTSMF.</li> </ul>		5	
	Stopping was specified for a TRID that does not exist.		63	
	Common criteria* <sup>1</sup>	Common processing	---	

\*1. Refer to *When Host Sends the Primary Message* on page 5-7 for the common criteria and applicable processing.

- 3** The host connection function returns Trace Initialize Acknowledge (S2,F24).
- 4** For each trace of the REPGSZ number, the host connection function returns Trace Data Send (S6,F1) with the trace data collection results attached.  
Tracing ends when the number of traces reaches TOTSMF.
- 5** The host sends Trace Data Acknowledge (S6,F2).



### Precautions for Correct Use

The Trace Data Send (S6,F1) SECS message is not sent if the maximum message length of 256 Kbytes is exceeded. Also, a Too Long SECS Message event (event code 66020000 hex) is registered. However, Trace Initialize Acknowledge (S2,F24) is sent normally.

To prevent exceeding the maximum message length, make sure that the total size of the status variables specified for tracing with Trace Initialize Send (S2,F23) times REPGSZ does not exceed 225 Kbytes.

## 5-5-10 Status Data Collection

Status data collection is based on the Status Data Collection additional GEM capability.

The design items required to achieve this function are given in the following table along with references.

Item	Requirement	Reference
Settings on the SECS/GEM Configurator	Required.	8-9-3 Status Variable (SV) on page 8-50
Creating the user program on the Sysmac Studio	Not required.	---

### Status Data Collection

The host can ask for the specified status information based on the Status Data Collection additional GEM capability.

The host connection function manages status data collection. You do not need to perform management for status data collection.

### Status Data Collection Scenarios

There are the following two Status Data Collection scenarios.

- Request Equipment Status Report
- Request Equipment Status Variable Namelist

#### ● Request Equipment Status Report

The following procedure is used for the Request Equipment Status Report scenario.

- 1 The host sends Selected Equipment Status Request (S1,F3).
- 2 The host connection function determines if the received primary message is normal.  
The normal/error results and factors, and the host connection function processing for each, are given in the following table. The table also tells if the user program is notified.

Result	Factor	Host connection function processing	Notifi- cation
Normal	---	Sends Selected Equipment Status Data (S1,F4) to the host.	None
Error	Common criteria*1	Common processing	

\*1. Refer to *When Host Sends the Primary Message* on page 5-7 for the common criteria and applicable processing.

- 3 The host connection function returns Selected Equipment Status Data (S1,F4).



#### Precautions for Correct Use

Only the header of the Selected Equipment Status Data (S1,F4) SECS message is sent if the maximum message length of 256 Kbytes is exceeded. Also, a Too Long SECS Message event (event code 66020000 hex) is registered.

To prevent exceeding the maximum message length, make sure that the total size of the status variables specified for reading with Selected Equipment Status Request (S1,F3) does not exceed 250 Kbytes.

### ● Request Equipment Status Variable Namelist

The following procedure is used for the Request Equipment Status Variable Namelist scenario.

- 1** The host sends Status Variable Namelist Request (S1,F11).
- 2** The host connection function determines if the received primary message is normal.  
The normal/error results and factors, and the host connection function processing for each, are given in the following table. The table also tells if the user program is notified.

Result	Factor	Host connection function processing	Notifica- tion
Normal	---	Sends Status Variable Namelist Reply (S1,F12) to the host.	None
Error	Common criteria *1	Common processing	

\*1. Refer to *When Host Sends the Primary Message* on page 5-7 for the common criteria and applicable processing.

- 3** The host connection function returns Status Variable Namelist Reply (S1,F12).

## 5-5-11 Alarm Management

Alarm management is based on the Alarm Management additional GEM capability.

The design items required to achieve this function are given in the following table along with references.

Item	Requirement	Reference
Settings on the SECS/GEM Configurator	Required.	8-11-2 Alarm Management on page 8-69
Creating the user program on the Sysmac Studio	Required.	This section

### Alarm Management

The equipment can notify the host of the alarm status that occurs on the equipment based on the Alarm Management additional GEM capability.

When alarms occur on the equipment and when they are cleared are managed in the user program. The user program executes the Report Alarm (GEM\_ReportAlarm) instruction when an alarm occurs or is cleared.

The main specification of alarm management is given in the following table.

Item	Specification
Maximum number of registered alarms	1024

### Alarm Management Scenarios

There are the following three Alarm Management scenarios.

- Send Alarm Report
- Enable/Disable Alarms
- Send Alarm Information

#### ● Send Alarm Report

The following procedure is used for the Send Alarm Report scenario.

- 1** You execute the Report Alarm (GEM\_ReportAlarm) instruction when an alarm that was defined on the SECS/GEM Configurator occurs or is cleared.
- 2** The host connection function sends Alarm Report Send (S5,F1).
- 3** The host sends Alarm Report Acknowledge (S5,F2).

The host connection function will not send Alarm Report Send (S5,F1) when an alarm for which the ALID is disabled occurs or is cleared. Event Report Send (S6,F11) is sent only for collection events that are sent automatically.

### ● Enable/Disable Alarms

The following procedure is used for the Enable/Disable Alarms scenario.

- 1** The host sends Enable/Disable Alarm Send (S5,F3).
- 2** The host connection function determines if the received primary message is normal.

The normal/error results and factors, and the host connection function processing for each, are given in the following table. The table also tells if the user program is notified.

Result	Factor	Host connection function processing		Notification
		Processing	Value of ACKC5	
Normal	---	<ul style="list-style-type: none"> <li>• Sends Enable/Disable Alarm Acknowledge (S5,F4) to the host.</li> <li>• The alarm enable/disable setting of the specified ALID is changed.</li> </ul>	0	None
Error	The ALID is not registered.	Sends Enable/Disable Alarm Acknowledge (S5,F4) to the host.	63	
	Common criteria <sup>*1</sup>	Common processing	---	

\*1. Refer to *When Host Sends the Primary Message* on page 5-7 for the common criteria and applicable processing.

- 3** The host connection function returns Enable/Disable Alarm Acknowledge (S5,F4).

The default value of the *AlarmsEnabled* status variable is set on the SECS/GEM Configurator.

### ● Send Alarm Information

The following procedure is used for the Send Alarm Information scenario.

- 1** The host sends List Alarms Request (S5,F5).
- 2** The host connection function determines if the received primary message is normal.

The normal/error results and factors, and the host connection function processing for each, are given in the following table. The table also tells if the user program is notified.

Result	Factor	Host connection function processing	Notification
Normal	---	Sends List Alarm Data (S5,F6) to the host.	None
Error	Common criteria <sup>*1</sup>	Common processing	

\*1. Refer to *When Host Sends the Primary Message* on page 5-7 for the common criteria and applicable processing.

- 3** The host connection function returns List Alarm Data (S5,F6).

## Alarm Management State Transitions

The alarm management states operate according to the following state transition diagram. The host connection function issues the state transition SECS messages.

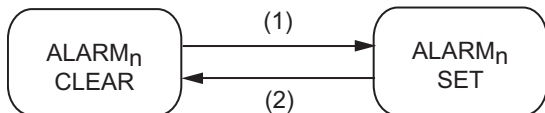

The above state transition triggers and equipment operation are described in the following table. The numbers in the table correspond to the numbers in the figure.

No.	Current state	Trigger	New state	Operation
(1)	ALARM <sub>n</sub> CLEAR	Alarm <sub>n</sub> is detected on the equipment. The Report Alarm (GEM_ReportAlarm) instruction is executed to report the occurrence of the alarm to the host.	ALARM <sub>n</sub> SET	Update <i>AlarmSet</i> and ALCD <sub>n</sub> values. Issue Alarm Report Send (S5,F1) if it is enabled. If a collection event is set to be issued when the alarm occurs, issue Event Report Send (S6,F11).
(2)	ALARM <sub>n</sub> SET	Alarm <sub>n</sub> is no longer detected on the equipment. The Report Alarm (GEM_ReportAlarm) instruction is executed to report the clearing of the alarm to the host.	ALARM <sub>n</sub> CLEAR	Update <i>AlarmSet</i> and ALCD <sub>n</sub> values. Issue Alarm Report Send (S5,F1) if it is enabled. If a collection event is set to be issued when the alarm is cleared, issue Event Report Send (S6,F11).

## 5-5-12 Host Commands

Host commands are based on the Remote Control additional GEM capability.

The design items required to achieve this function are given in the following table along with references.

Item	Requirement	Reference
Setting with the SECS/GEM Configurator	Required.	8-11-3 <i>Host Command</i> on page 8-72
Creating the user program on the Sysmac Studio	Required.	This section

### Host Commands

The host can control overall equipment operation in stages (remote/local) based on the Remote Control additional GEM capability.

The commands to use are set under **Remote Control - Host Command** on the List Menu of the SECS/GEM Configurator.

The main specifications of the host commands are given in the following table.

Item	Specification
Maximum number of registered host commands	32
Maximum number of CPNAMEs registered in one host command	32

### Host Command Structure

A host command consists of command parameters.

A command parameter consists of CPNAME, which gives a command parameter name, and CPVAL, which gives a command parameter value.

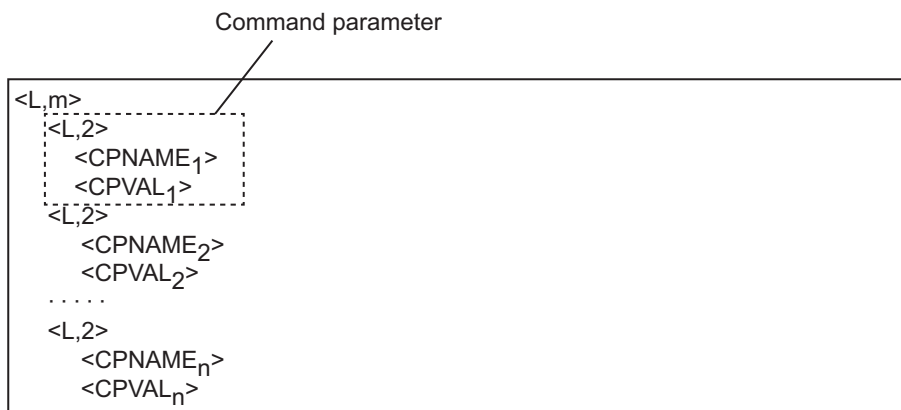



## Relationship between Message Structure and Link Variables

The relationship between the message structure and link variables for Host Command Send (S2,F41) and Host Command Acknowledge (S2,F42) is described below using the START host command as an example.

The START host command has the following three command parameters.

CPNAME	CPVAL	
	Format	Data size [bytes]
PPID	A*1	80*1
LOTID	A	16
MID	A	16

\*1. Set the same format and data size as the *PPID* that was defined in the item definitions.

### ● Host Command Send (S2,F41) Message Structure and Link Variables

This section describes the relationship between the message structure and link variables for Host Command Send (S2,F41).

Link variables are assigned to the items of Host Command Send (S2,F41). You use the SECS/GEM Configurator to assign the link variables.

First, select **GEM Capability Settings - Remote Control - Host Command**, and assign link variables to *Link variable for S2F41: RCMD* and *Link variable for S2F41:CPNAME list* on the Operation settings Tab Page. The meanings of the link variables are described in the following figure.

Variable to store RCMD received from host

The data type is STRING[21].

STRING[21] has the same format and data size as the *RCMD* that was defined in the item definitions.

In this example,  
S2F41\_RCMD = 'START'.

Variable to store number of CPNAMEs received from host

In this example,  
S2F41:CPNAME\_NUMBER = 3.

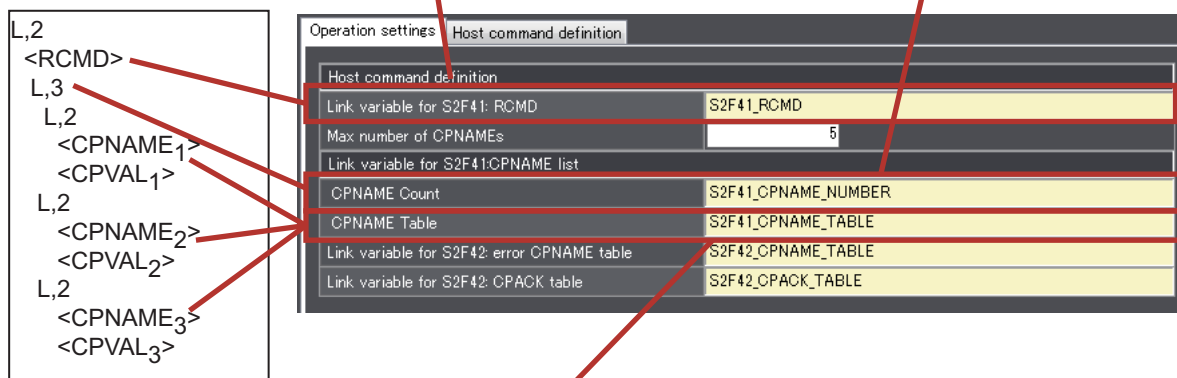

Array to store the CPNAMEs received from host

The data type is ARRAY[0..4] OF STRING[21].

STRING[21] has the same format and data size as the *CPNAME* that was defined in the item definitions.

In this example,  
S2F41\_CPNAME\_TABLE[0] = 'PPID',  
S2F41\_CPNAME\_TABLE[1] = 'LOTID', and  
S2F41\_CPNAME\_TABLE[2] = 'MID'.

Next, you assign the link variables to the CPVALs on the *Host command definition* Tab Page. The meanings of the link variables are described in the following figure.

Variable to store RCMD received from host  
The data type is STRING[80].

STRING[80] has the same format and data size as the *PPID* that was defined in the item definitions.

L,2  
<RCMD>  
L,3  
L,2  
  <CPNAME<sub>1</sub>>  
  <CPVAL<sub>1</sub>>  
L,2  
  <CPNAME<sub>2</sub>>  
  <CPVAL<sub>2</sub>>  
L,2  
  <CPNAME<sub>3</sub>>  
  <CPVAL<sub>3</sub>>

CPNAME		CPVAL			
Name	Omission	Order fixed	Format	Data size	Link variable
PPID	<input type="checkbox"/>	<input type="checkbox"/>	A	80	S2F41_CPVAL_START_PPID
LOTID	<input type="checkbox"/>	<input type="checkbox"/>	A	16	S2F41_CPVAL_START_LOTID
MID	<input type="checkbox"/>	<input type="checkbox"/>	A	16	S2F41_CPVAL_START_MID

● **Host Command Acknowledge (S2,F42) Message Structure and Link Variables**

This section describes the relationship between the message structure and link variables for Host Command Acknowledge (S2,F42).

Link variables are assigned to the items of Host Command Acknowledge (S2,F42). You use the SECS/GEM Configurator to assign the link variables.

You select **GEM Capability Settings - Remote Control - Host Command**, and assign link variables to *Link variable for S2F42: error CPNAME table* and *Link variable for S2F42: CPACK table* on the Operation settings Tab Page. The meanings of the link variables are described in the following figure.

In this example, the results of verifying the host command in the user program show that *LOTID* and *MID* are not correct.

In the following figure, the values of HCACK and the number of command parameter errors *CPErrrorNum* are specified as input variables to the Acknowledge Host Command (GEM\_AckHostCmd) instruction. In this example, the value of *CPErrrorNum* is 2.

Array to store CPNAMEs determined to be in error  
The data type is ARRAY[0..4] OF STRING[21].

STRING[21] has the same format and data size as the *CPNAME* that was defined in the item definitions.

In this example,  
S2F42\_CPNAME\_TABLE[0] = 'LOTID' and  
S2F42\_CPNAME\_TABLE[1] = 'MID'.

L,2  
<HCACK>  
L,2  
L,2  
  <CPNAME<sub>1</sub>>  
  <CPACK<sub>1</sub>>  
L,2  
  <CPNAME<sub>2</sub>>  
  <CPACK<sub>2</sub>>

Link variable for S2F41: RCMD	S2F41_RCMD
Max number of CPNAMEs	5
Link variable for S2F41:CPNAME list	
CPNAME Count	S2F41_CPNAME_NUMBER
CPNAME Table	S2F41_CPNAME_TABLE
Link variable for S2F42: error CPNAME table	S2F42_CPNAME_TABLE
Link variable for S2F42: CPACK table	S2F42_CPACK_TABLE

Array to store CPACKs determined to be in error  
The data type is ARRAY[0..4] OF BYTE.

In this example,  
S2F42\_CPACK\_TABLE[0] = 16#03 and  
S2F42\_CPACK\_TABLE[1] = 16#03.

## **\_GEM\_Interlock\_HostCmd Interlock Variable**

The `_GEM_Interlock_HostCmd` interlock variable is related to host commands.

The relationship between the Host Commands scenario and the SECS messages that are interlocked is given in the following table.

Scenario	Interlocked SECS message
Host Command	Host Command Send (S2,F41)

## **Host Command Scenario**

The following procedure is used for the Host Commands scenario.

- 1** The host sends Host Command Send (S2,F41).
- 2** The host connection function determines if the received primary message is normal.  
The normal/error results and factors, and the host connection function processing for each, are given in the following table. The table also tells if the user program is notified.

Result	Factor	Host connection function processing		Notifi- cation
		Processing	Value of HCACK	
Normal	---	Changes the value of <code>_GEM_BusyHostCmd</code> (Host Command Transaction Processing Flag) to TRUE.	---	Yes
Error	The RCMD is not registered.	Sends Host Command Acknowledge (S2,F42) to the host.	1	None
	The value of the <code>_GEM_Interlock_HostCmd</code> interlock variable is TRUE.		2	
	An incorrect parameter was received. Details are given below.		3	
	The Host Command GEM capability is disabled.		60	
	Common criteria <sup>*1*1</sup>		Common processing	

\*1. Refer to *When Host Sends the Primary Message* on page 5-7 for the common criteria and applicable processing.

The following table gives detailed factors for “An incorrect parameter was received” in the above table and the values of CPACK returned to the host.

Detailed error factor	Value of CPACK
The CPNAME is not registered.	1
A CPNAME that was not omitted was not received.	---
CPNAMEs with a fixed reception order were not in the set order.	1
The same CPNAME is used twice.	63
The format of CPVAL is different from the setting.	3

- 3** Perform processing in the user program for RCMD, CPNAME, and CPVAL.
- 4** The host connection function returns Host Command Acknowledge (S2,F42).  
To return Host Command Acknowledge (S2,F42), execute the Acknowledge Host Command (`GEM_AckHostCmd`) instruction in the user program.

### 5-5-13 Enhanced Remote Commands

Enhanced remote commands are based on the Remote Control additional GEM capability.

The design items required to achieve this function are given in the following table along with references.

Item	Requirement	Reference
Setting with the SECS/GEM Configurator	Required.	8-11-4 Enhanced Remote Command on page 8-76
Creating the user program on the Sysmac Studio	Required.	This section

#### Enhanced Remote Command

The host can control overall equipment operation in stages (remote/local) based on the Remote Control additional GEM capability.

The main specifications of the enhanced host commands are given in the following table.

Item	Specification
Maximum number of registered enhanced remote commands	32
Maximum number of CPNAMEs registered in one enhanced remote command	32

You cannot use a list data structure for CEPVAL in the primary message. Therefore, the data structure must use CPNAME and CPVAL in pairs as shown below.

```

L,4
1.<DATAID>
2.<OBJSPEC>
3.<RCMD>
4.L,m
  1.L,2
    1.<CPNAME1>
    2.<CEPVAL1>
  2.L,2
    1.<CPNAME2>
    2.<CEPVAL2>
  .
  .
m.L,2
  1.<CPNAMEm>
  2.<CEPVALm>

```

#### \_GEM\_Interlock\_EnhancedRmtCmd Interlock Variable

The \_GEM\_Interlock\_EnhancedRmtCmd interlock variable is related to enhanced remote commands. The relationship between the Enhanced Remote Command scenario and the SECS messages that are interlocked is given in the following table.

Scenario	Interlocked SECS message
Enhanced Remote Command	Enhanced Remote Command (S2,F49)

## Enhanced Remote Command Scenario

The following procedure is used for the Enhanced Remote Command scenario.

- 1** The host sends Enhanced Remote Command (S2,F49).
- 2** The host connection function determines if the received primary message is normal.  
The normal/error results and factors, and the host connection function processing for each, are given in the following table. The table also tells if the user program is notified.

Result	Factor	Host connection function processing		Notifi- cation
		Processing	Value of HACK	
Normal	---	Changes the value of <i>_GEM_BusyEnhancedRmtCmd</i> (Enhanced Remote Command Transaction Processing Flag) to TRUE.	---	Yes
Error	The RCMD is not registered.	Sends Enhanced Remote Command Acknowledge (S2,F50) to the host.	1	None
	The value of the <i>_GEM_Interlock_EnhancedRmtCmd</i> interlock variable is TRUE.		2	
	An incorrect parameter was received. Details are given below.		3	
	The Enhanced Remote Command GEM capability is disabled.		60	
	Common criteria <sup>*1*1</sup>		---	
	Common processing	---		

\*1. Refer to *When Host Sends the Primary Message* on page 5-7 for the common criteria and applicable processing.

The following table gives detailed factors for “An incorrect parameter was received” in the above table and the values of CEPACK returned to the host.

Detailed error factor	Value of CEPACK
The CPNAME is not registered.	1
A CPNAME that was not omitted was not received.	---
CPNAMEs with a fixed reception order were not in the set order.	1
The same CPNAME is used twice.	63
The format of CEPVAL is different from the setting.	3

- 3** Perform processing in the user program for RCMD, CPNAME, and CEPVAL.
- 4** The host connection function returns Enhanced Remote Command Acknowledge (S2,F50).  
To return Enhanced Remote Command Acknowledge (S2,F50), execute the Acknowledge Enhanced Remote Command (*GEM\_AckEnhancedRmtCmd*) instruction in the user program.

## 5-5-14 Equipment Constants

The equipment constants are based on the Equipment Constants additional GEM capability.

The design items required to achieve this function are given in the following table along with references.

Item	Requirement	Reference
Setting with the SECS/GEM Configurator	Required.	8-9-2 <i>Equipment Constant (EC)</i> on page 8-47 8-11-5 <i>Equipment Constants</i> on page 8-80
Creating the user program on the Sysmac Studio	Required.	This section

### Equipment Constants

The host can read the specified equipment constants in the equipment and change the values of specified equipment constants in the equipment based on the Equipment Constants additional GEM capability.

The main specification of equipment constants is given in the following table.

Item	Specification
Maximum number of equipment constants for which changes can be requested by the host at the same time	100



#### Precautions for Correct Use

- The host connection function checks the upper and lower limits of the values of equipment constants. However, if the format of the equipment constant is not a number, the upper/lower limit check is not performed. The following values are used for the upper and lower limits for equipment constants.

Upper/lower limit	Value used for check
Upper limit	ECMAX set on the SECS/GEM Configurator
Lower limit	ECMIN set on the SECS/GEM Configurator

- The value of retained variables is lost if the power supply to the Controller is turned OFF when a battery is not mounted or the battery voltage is low. Therefore, the values of equipment constants are lost. The next time the power supply to the Controller is turned ON, the values of equipment constants will be the ECDEF values set on the SECS/GEM Configurator.

## Equipment Constant Scenarios

---

There are the following three Equipment Constant scenarios.

- Operator Changes Equipment Constant
- Host Sends Equipment Constants
- Host Equipment Constant Namelist Request

### ● Operator Changes Equipment Constant

The following procedure is used for the Operator Changes Equipment Constant scenario.

- 1** The user executes the Change Equipment Constant (GEM\_ChangeECV) instruction.
- 2** The user executes the Report Event (GEM\_ReportEvent) instruction to report an Operator Equipment Constant Change collection event.

Refer to *8-11-1 Event Notification* on page 8-61 for the setting procedure for the Operator Equipment Constant Change collection event.



### Precautions for Correct Use

---

#### Changing Equipment Constants

Link variables for equipment constants have a Constant attribute, so their values cannot be changed with value assignments. Use the Change Equipment Constant (GEM\_ChangeECV) instruction to change the values of equipment constants. The values of the link variables of the relevant equipment constants change when execution of the GEM\_ChangeECV instruction is completed normally.

#### Changing Multiple Equipment Constants

Use the following steps to change more than one equipment constant.

- (1)Execute the GEM\_ChangeECV instruction for each of the equipment constants to change.
  - (2)Specify an array containing all of the ECIDs to change and execute the GEM\_ReportEvent instruction once.
-

## ● Host Sends Equipment Constants

The following procedure is used for the Host Sends Equipment Constants scenario.

### 1 The host sends New Equipment Constant Send (S2,F15).

To return Host Command Acknowledge (S2,F42), execute the Acknowledge Host Command (GEM\_AckHostCmd) instruction in the user program.

### 2 The host connection function determines if the received primary message is normal.

The normal/error results and factors, and the host connection function processing for each, are given in the following table. The table also tells if the user program is notified.

Result	Factor	Host connection function processing		Notification
		Processing	Value of EAC	
Normal	---	Changes the value of <code>_GEM_BusyHostChangeECV</code> (Change Equipment Constant Transaction Processing Flag) to TRUE.	---	Yes
Error	The ECID is not registered.	Sends New Equipment Constant Acknowledge (S2,F16) to the host.	1	None
	The value of the <code>_GEM_Interlock_ECV</code> interlock variable is TRUE.		2	
	The value of ECV is out of range.		3	
	The Equipment Constants GEM capability is disabled.		60	
	The number of ECs for which changes are requested exceeds the maximum value that is set.		63	
	Common criteria* <sup>1</sup>	Common processing	---	

\*1. Refer to *When Host Sends the Primary Message* on page 5-7 for the common criteria and applicable processing.

### 3 The host connection function returns New Equipment Constant Acknowledge (S2,F16).

To return New Equipment Constant Acknowledge (S2,F16), execute the Acknowledge Equipment Constant Change (GEM\_AckChangeECV) instruction in the user program.



● **Host Equipment Constant Namelist Request**

The following procedure is used for the Host Equipment Constant Namelist Request scenario.

- 1** The host sends Equipment Constant Namelist Request (S2,F29).
- 2** The host connection function determines if the received primary message is normal.  
The normal/error results and factors, and the host connection function processing for each, are given in the following table. The table also tells if the user program is notified.

Result	Factor	Host connection function processing	Notifi- cation
Normal	---	Sends Equipment Constant Namelist (S2,F30) to the host.	None
Error	Common criteria *1	Common processing	

\*1. Refer to *When Host Sends the Primary Message* on page 5-7 for the common criteria and applicable processing.

- 3** The host connection function returns Equipment Constant Namelist (S2,F30).

**\_GEM\_Interlock\_ECV Interlock Variable**

The *\_GEM\_Interlock\_ECV* interlock variable is related to equipment constants.

The relationship between the Equipment Constant scenarios and the SECS messages that are interlocked is given in the following table.

Scenario	Interlocked SECS message
Operator Changes Equipment Constant	None
Host Sends Equipment Constants	New Equipment Constant Send (S2,F15)
Host Equipment Constant Namelist Request	None

## 5-5-15 Process Program Management

Process program management is based on the Process Program Management additional GEM capability.

The design items required to achieve this function are given in the following table along with references.

Item	Requirement	Reference
Setting with the SECS/GEM Configurator	Required.	8-11-6 <i>Process Program Management</i> on page 8-81
Creating the user program on the Sysmac Studio	Required.	This section

### Process Program Management

The process programs can be managed between the host and equipment based on the Process Program Management additional GEM capability.

However, E42 recipes, E139 recipes, and large process programs are not supported.

The main specifications of process programs are given in the following table.

Item	Specification
Maximum size of process program [Kbytes] <sup>*1*2</sup>	1 to 257
Maximum number of saved process programs	40

\*1. This is the size without a header for Process Program Send (S7,F3) and Formatted Process Program Send (S7,F23).

\*2. The maximum size of a process program is set on the SECS/GEM Configurator as *Permissible message LENGTH*.

The scenarios that are supported for process program management and the applicable process program types are given in the following table.

Scenario	Unformatted process programs	Formatted process programs
Creation, Editing, or Deletion of Process Program by Operator	Applicable	Applicable
Process Program Deletion by Host	Applicable	Applicable
Process Program Directory Request	Applicable	Applicable
Equipment-initiated Process Program Upload	Applicable	
Host-initiated Process Program Upload	Applicable	
Equipment-initiated Process Program Download	Applicable	
Host-initiated Process Program Download	Applicable	
Equipment-initiated Formatted Process Program Upload		Applicable
Host-initiated Formatted Process Program Upload		Applicable
Equipment-initiated Formatted Process Program Download		Applicable
Host-initiated Formatted Process Program Download		Applicable

## Types of Process Programs

There are the following types of process programs.

- Unformatted process programs
- Formatted process programs

Hereafter, unless otherwise specified, “process program” refers to an unformatted process program.

### ● Process Program Specifications

A process program consists of one PPBODY item that is not structured. The message structure for a process program is given below.

```
<PPBODY>
```

The maximum size and data size setting range for a process program depends on the format, as shown in the following table.

Format	Maximum size [bytes]	Data size setting range
B	65,535	1 to 65,535
A	1,985	1 to 1,985
I1	65,535	1 to 65,535
I2	131,070	1 to 65,535
I4	262,140	1 to 65,535
U1	65,535	1 to 65,535
U2	131,070	1 to 65,535
U4	262,140	1 to 65,535

● **Formatted Process Program Specifications**

A formatted process program is expressed with commands. A command consists of the command code CCODE and the parameter PPARM that corresponds to the CCODE.

The formats of the CCODEs and PPARMs are defined on the SECS/GEM Configurator.

The main specifications of formatted process programs are given in the following table.

Item	Specification
Maximum number of registered CCODEs	50
Maximum number of PPARMs registered for one CCODE	20

- A PPARM is defined as a list of length-variable data.
- All of the PPARMs for a CCODE have the same format.
- The commands can be in any order in the message structure.

An example of a message structure for a formatted process program is given below.

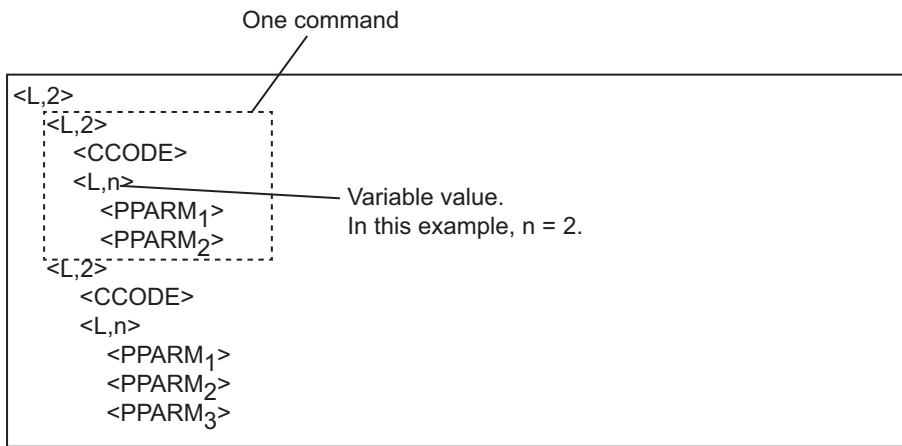

## PPID Management Table

A PPID Management Table is required on the equipment to manage process programs and formatted process programs. The PPIDs of process programs and formatted process programs are registered in the PPID Management Table. Only the user program can update the PPID Management Table. The host connection function can only access the PPID Management Table. It cannot update it.

The processing and corresponding scenarios for the PPID Management Table when a process program or formatted process program is created, edited, or deleted are given in the following table.

Item	Step No.	Processing	Scenario
Creation	1	Save the process program or formatted process program.	<ul style="list-style-type: none"> <li>• Creation in the Creation, Editing, or Deletion of Process Program by Operator scenario</li> <li>• Equipment-initiated Process Program Download scenario<sup>*1</sup></li> <li>• Host-initiated Process Program Download scenario<sup>*1</sup></li> <li>• Equipment-initiated Formatted Process Program Download scenario<sup>*1</sup></li> <li>• Host-initiated Formatted Process Program Download scenario<sup>*1</sup></li> </ul>
	2	Add the PPID to the PPID Management Table.	
Editing	1	Delete the PPID of the process program to edit from the PPID Management Table. <sup>*2</sup>	<ul style="list-style-type: none"> <li>• Editing in the Creation, Editing, or Deletion of Process Program by Operator scenario</li> <li>• Equipment-initiated Process Program Download scenario<sup>*3</sup></li> <li>• Host-initiated Process Program Download scenario<sup>*3</sup></li> <li>• Equipment-initiated Formatted Process Program Download scenario<sup>*3</sup></li> <li>• Host-initiated Formatted Process Program Download scenario<sup>*3</sup></li> </ul>
	2	Edit the process program or formatted process program.	
	3	Add the PPID of the process program that was edited to the PPID Management Table. <sup>*2</sup>	
Deletion	1	Delete the PPID of the process program to delete from the PPID Management Table.	<ul style="list-style-type: none"> <li>• Deletion in the Creation, Editing, or Deletion of Process Program by Operator scenario</li> </ul>
	2	Delete the process program or formatted process program.	

\*1. This scenario is used when a process program or formatted process program that is not in the equipment is downloaded.

\*2. This processing is not necessary if the PPID of the process program to edit is included in EPPD.

\*3. This scenario is used when a process program or formatted process program that is already in the equipment is edited.



### Precautions for Correct Use

- If you use a link variable for the PPID Management Table, set the variable attributes as follows: Retain attribute and no Constant attribute.
- It is assumed that a PPID is not registered for any element that is NULL in the link variable for the PPID Management Table.

## Retaining Process Programs and Formatted Process Programs for Power Interruptions

It is necessary to retain process programs and formatted process programs in memory when the power supply to the CPU Unit is turned OFF.

There are the following two ways to retain the process programs and formatted process programs.

### ● Storage in a User-defined Variable with a Retain Attribute

You can store a process program or formatted process program in a user-defined variable with a Retain attribute. If you use this method, the process programs and formatted process programs will be backed up along with the other backup data.

### ● Storage in Files on SD Memory Cards

You can use the FileWriteVar instruction or another SD Memory Card instruction to save process programs and formatted process programs as files on SD Memory Cards. If you use this method, you can manage the process programs and formatted process programs as files on a computer and edit them on the computer.

## Link Variables for Uploading and Downloading

Link variables are used between the user program and host connection function when process programs and formatted process programs are uploaded/downloaded between the host and equipment. The processing is divided into the following eight types.

The link variables that are used for each process are specified in the following table.

Process programs/formatted process programs	Processing	Link variables
Process programs	Host-initiated upload	PPBODY* <sup>1</sup>
	Equipment-initiated upload	PPBODY* <sup>1</sup>
	Host-initiated download	PPBODY and LENGTH
	Equipment-initiated download	PPBODY and LENGTH
Formatted process programs	Host-initiated upload	CCODE table, PPARAM count, and PPARAM table* <sup>2</sup>
	Equipment-initiated upload	CCODE table, PPARAM count, and PPARAM table
	Host-initiated download	CCODE count, CCODE table, PPARAM count, and PPARAM table
	Equipment-initiated download	CCODE count, CCODE table, PPARAM count, and PPARAM table

\*1. LENGTH is specified in an input variable to the GEM instruction.

\*2. The CCODE count is specified in an input variable to the GEM instruction.

The relationship between the user program, host connection function, and link variables is shown in the following figure.

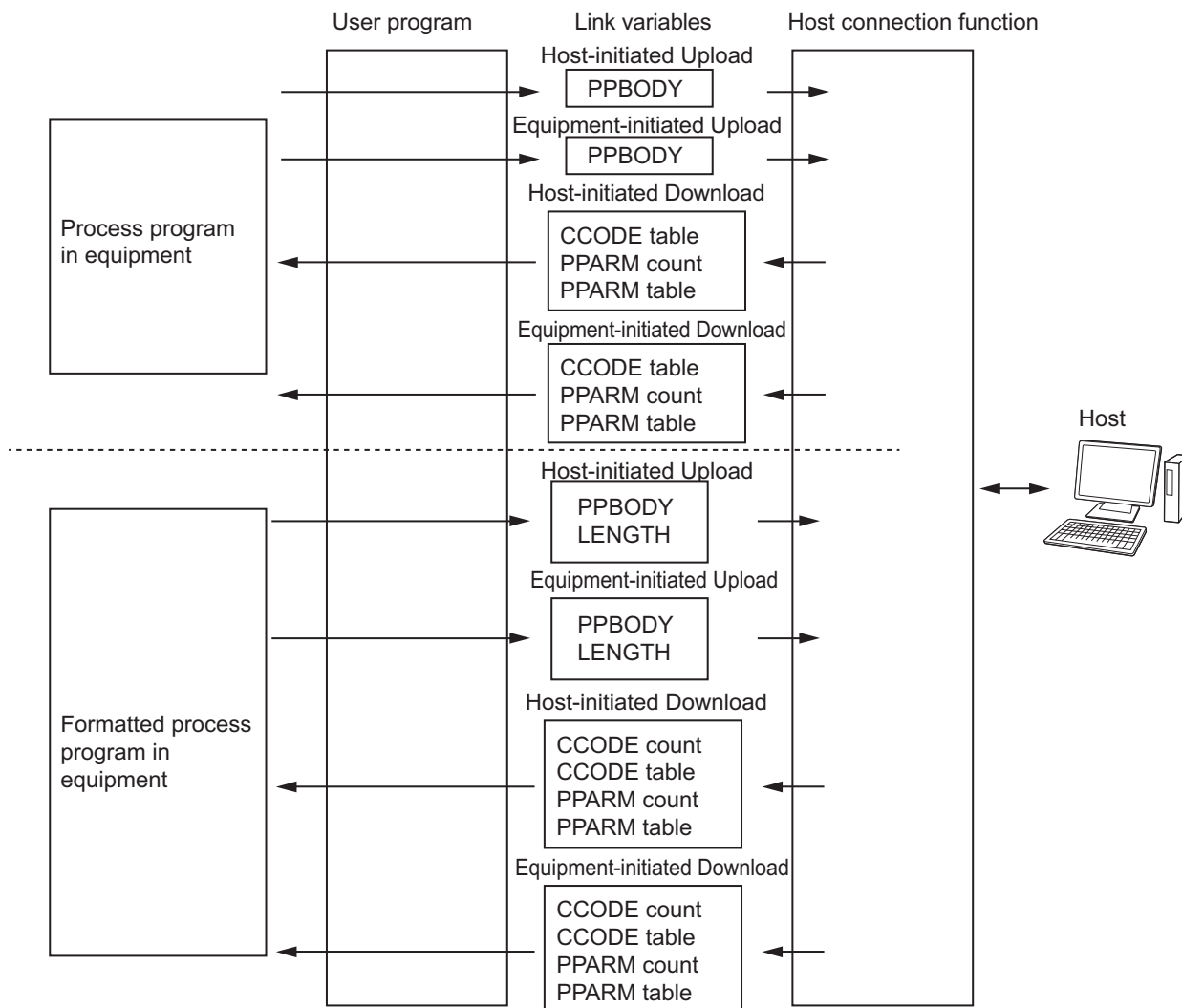

The difference in processing for an upload and a download is described in the following table.

Upload/download	Processing
Upload	The user program updates the link variable and the host connection function accesses the link variable.
Download	The host connection function updates the link variable and the user program accesses the link variable.

## Relationship between Message Structure and Link Variables

This section describes the relationship between the message structure for process programs and formatted process programs and the link variables. Refer to *8-11-6 Process Program Management* on page 8-81 for details on setting process programs on the SECS/GEM Configurator.

### ● Message Structure of Process Programs and Link Variables

This section describes the relationship between the message structure for process programs and the link variables, using an equipment-initiated download as an example.

The message structure for a process program is shown in the following figure.

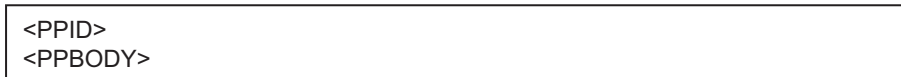

The meanings of the link variables are given in the following figure.

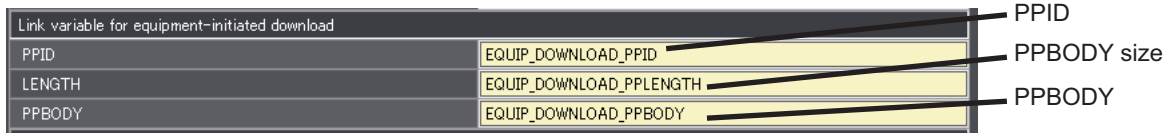

### ● Message Structure of Formatted Process Programs and Link Variables

This section describes the relationship between the message structure for formatted process programs and the link variables, using an equipment-initiated download as an example. An example of a message structure for a formatted process program is given in the following figure.

In this example, the formatted process program consists of CCODEs 1 and 2.

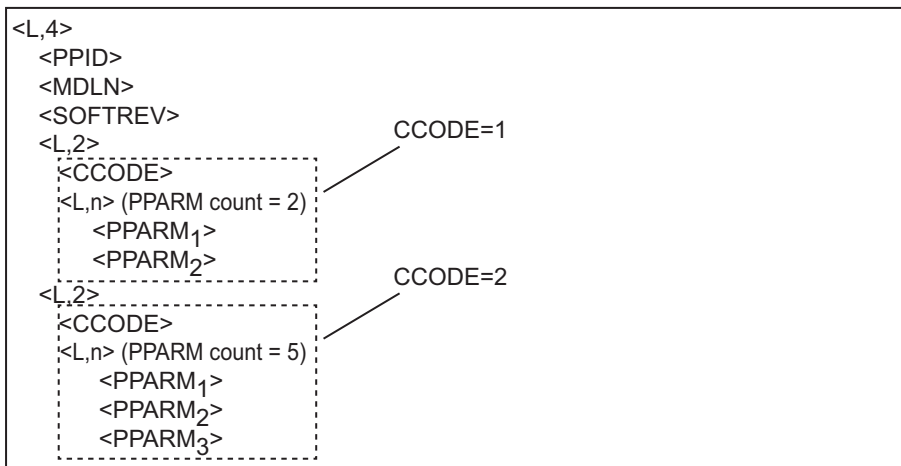



First, for each CCODE, link variables are assigned for the PPARAM table and PPARAM count. The definition of CCODE 1 and the meanings of the link variables are given below.

Definition of CCODE 1

```

<L,4>
<PPID>
<MDLN>
<SOFTREV>
<L,2>
  <CCODE>
  <L,n> (PPARM count = 2)
    <PPARM1>
    <PPARM2>
  <L,2>
  <CCODE>
  <L,n> (PPARM count = 5)
    <PPARM1>
    <PPARM2>
    <PPARM3>
        
```

CCODE/PPARM definition			
No.	1	CCODE	1
Description		sample1	
PPARM	Format	U1	Element count
Link variable for PPARAM			
Use	PPARM table	PPARM count	
Equipment-initiated upload	EQUIP_UPLOAD_FPP_PPARM1_TABLE	EQUIP_UPLOAD_FPP_PPARM1_NUMBER	
Equipment-initiated download	EQUIP_DOWNLOAD_FPP_PPARM1_TABLE	EQUIP_DOWNLOAD_FPP_PPARM1_NUMB...	
Host-initiated download	HOST_UPLOAD_FPP_PPARM1_TABLE	HOST_UPLOAD_FPP_PPARM1_NUMBER	
Host-initiated upload	HOST_DOWNLOAD_FPP_PPARM1_TABLE	HOST_DOWNLOAD_FPP_PPARM1_NUMBE...	

Array to store the values for PPARM<sub>1</sub> and PPARM<sub>2</sub>

Variable to store PPARM count  
In this example, PPARM count = 2.

Next, the link variables for the CCODEs are assigned. The meanings of the link variables are given in the following figure.

```

<L,4>
<PPID>
<MDLN>
<SOFTREV>
<L,2>
  <CCODE>
  <L,n> (PPARM count = 2)
    <PPARM1>
    <PPARM2>
  <L,2>
  <CCODE>
  <L,n> (PPARM count = 5)
    <PPARM1>
    <PPARM2>
    <PPARM3>
        
```

Link variable for equipment-initiated download	
PPID	EQUIP_DOWNLOAD_FPP_PPID
MDLN	EQUIP_DOWNLOAD_FPP_MDLN
SOFTREV	EQUIP_DOWNLOAD_FPP_SOFTREV
CCODE count	EQUIP_DOWNLOAD_FPP_CCODE_NUMBER
CCODE table	EQUIP_DOWNLOAD_FPP_CCODE_TABLE

CCODE count  
In this example, CCODE count = 2.

Array to store the values of the CCODEs  
In this example,  
EQUIP\_DOWNLOAD\_FPP\_CCODE\_NUMBER[0] = 1 and  
EQUIP\_DOWNLOAD\_FPP\_CCODE\_NUMBER[1] = 2.

## **\_GEM\_Interlock\_PP Interlock Variable**

The *\_GEM\_Interlock\_PP* interlock variable is related to the process programs and formatted process programs.

The relationship between the process program and formatted process program scenarios and the SECS messages that are interlocked is given in the following table.

<b>Scenario</b>	<b>Interlocked SECS message</b>
Creation, Editing, or Deletion of Process Program by Operator	None
Process Program Deletion by Host	Delete Process Program Send (S7,F17)
Process Program Directory Request	None
Equipment-initiated Process Program Upload	None
Host-initiated Process Program Upload	Process Program Request (S7,F5)
Equipment-initiated Process Program Download	None
Host-initiated Process Program Download	<ul style="list-style-type: none"> <li>• Process Program Load Inquire (S7,F1)</li> <li>• Process Program Send (S7,F3)</li> </ul>
Equipment-initiated Formatted Process Program Upload	None
Host-initiated Formatted Process Program Upload	Formatted Process Program Request (S7,F25)
Equipment-initiated Formatted Process Program Download	None
Host-initiated Formatted Process Program Download	<ul style="list-style-type: none"> <li>• Process Program Load Inquire (S7,F1)</li> <li>• Formatted Process Program Send (S7,F23)</li> </ul>

## Programming Procedure

Use the following programming procedure on the Sysmac Studio to use process programs and formatted process programs.

### 1 Setting the Initial Values of Link Variables

Set the initial values of the following link variables. Set the initial values when the GEM Service status is EQinitializing. Refer to *5-1-1 Starting and Pausing the Host Connection Function* on page 5-3 for information on the initial value settings of link variables.

Variable	Link variable name	Setting
PPFormat status variable	_GEM_PPFormat	Support for process programs/formatted process programs 0: Neither is supported. 1: Only process programs are supported. 2: Only formatted process programs are supported. 3: Both are supported.
PPID Management Table	User-set variable name	To record process programs and formatted process programs in the equipment, the PPIDs are registered in the PPID Management Table.

### 2 Creating the User Program According to the Scenarios

Create the user program according to the scenarios. Details on the processing for the process program and formatted process program scenarios are given later. Also, refer to the descriptions of the GEM instructions that are used for scenario processing. Refer to *A-1 GEM Instructions* on page A-3 for information on the GEM instructions.

### 3 Process Program Selection

When you select a process program in the user program, you must notify the host of the PPID using a collection event. To do so, the CEID of the Process Program Selected collection event is specified and the Report Event (GEM\_ReportEvent) instruction is executed in the user program.

You also set a discrete link variable for the Process Program Selected collection event.

Discrete variable	Link variable	Description
PPExecName	_GEM_PPExecName	PPID of currently selected process program

## Scenario Processing

This section describes the processing for the process program and formatted process program scenarios. There are the following eleven scenarios.

- Creation, Editing, or Deletion of Process Program by Operator
- Process Program Deletion by Host
- Process Program Directory Request
- Equipment-initiated Process Program Upload
- Host-initiated Process Program Upload
- Equipment-initiated Process Program Download
- Host-initiated Process Program Download
- Equipment-initiated Formatted Process Program Upload
- Host-initiated Formatted Process Program Upload
- Equipment-initiated Formatted Process Program Download
- Host-initiated Formatted Process Program Download

### ● Creation, Editing, or Deletion of Process Program by Operator

After the operator creates, edits, or deletes a process program and formatted process program, the host is notified with a Process Program Change collection event.

The following procedure is used.

- 1** The equipment changes the process program or formatted process program and the PID Management Table according to the creation, edition or deletion contents of process programs or formatted process programs.
- 2** The host connection function sends the collection event.

To send the collection event, the CEID of the Process Program Change collection event is specified and the GEM\_ReportEvent instruction is executed in the user program.

At the time, the following values are set in the discrete variable assigned to the Process Program Change collection event.

Discrete variable	Link variable	Description
PPChange Name	_GEM_PPChangeInfo.PPChangeName	PPID of the process program or formatted process program that was created, edited, or deleted by the operator.
PPChange Status	_GEM_PPChange-Info.PPChangeStatus	Processing type for process program or formatted process program 1: Created 2: Edited 3: Deleted

● **Process Program Deletion by Host**

The following procedure is used for the Host-initiated Process Program Deletion scenario or the Host-initiated Formatted Process Program Deletion scenario.

- 1** Delete Process Program Send (S7,F17) is received from the host.
- 2** The host connection function determines if the received primary message is normal.  
The normal/error results and factors, and the host connection function processing for each, are given in the following table. The table also tells if the user program is notified.

Result	Factor	Host connection function processing		Notifi- cation
		Processing	Value of ACKC7	
Normal	---	Changes the value of <code>_GEM_BusyHostPPDelete</code> (Host-initiated Process Program Deletion Transaction Processing Flag) to TRUE.	---	Yes
Error	The PPID is not saved in the PPID Management Table.	Sends Delete Process Program Acknowledge (S7,F18) to the host.	1	None
	The value of PPID is NULL.		4	
	The value of the <code>_GEM_Interlock_PP</code> interlock variable is TRUE.		5	
	The Process Program Management GEM capability is disabled.		60	
	The same PPID is used twice.		63	
	Common criteria <sup>*1</sup> <sup>*1</sup>		Common processing	

\*1. Refer to *When Host Sends the Primary Message* on page 5-7 for the common criteria and applicable processing.

The data received for Delete Process Program Send (S7,F17) is stored in *PPID count* and *PPID table* in the link variables for the deletion requested PPID list.

- 3** The user program deletes the PPID of the process program or formatted process program for which there was a deletion request from the PPID Management Table. Also, the process program/formatted process program for which there was a deletion request is deleted.  
If the PPID count for the deletion request is 0, all of the process programs and formatted process programs are deleted.
- 4** The host connection function returns Delete Process Program Acknowledge (S7,F18).  
To return Delete Process Program Acknowledge (S7,F18), execute the Acknowledge Process Program Deletion (`GEM_AckPPDelete`) instruction in the user program.

### ● Process Program Directory Request

The following procedure is used for the Process Program Directory Request scenario. The host connection function handles all of the processing for the process program directory request. No processing is required in the user program.

- 1** Current EPPD Request (S7,F19) is received from the host.
- 2** The host connection function determines if the received primary message is normal.

The normal/error results and factors, and the host connection function processing for each, are given in the following table. The table also tells if the user program is notified.

Result	Factor	Host connection function processing	Notification
Normal	---	Sends Current EPPD Data (S7,F20) to the host.	None
Error	Common criteria <sup>*1*1</sup>	Common processing	

\*1. Refer to *When Host Sends the Primary Message* on page 5-7 for the common criteria and applicable processing.

- 3** The host connection function returns Current EPPD Data (S7,F20).

### ● Equipment-initiated Process Program Upload

The following procedure is used for the Equipment-initiated Process Program Upload scenario.

- 1** The host connection function sends Process Program Load Inquire (S7,F1).  
To send Process Program Load Inquire (S7,F1), execute the Upload Process Program (GEM\_UploadPP) instruction in the user program.
- 2** Process Program Load Grant (S7,F2) is received from the host.

- 3** The host connection function determines if the received secondary message is normal.

The normal/error results and factors, and the host connection function processing for each, are given in the following table. The table also tells if the user program is notified.

Result	Factor	Host connection function processing	Notification
Normal	---	Sends Process Program Request (S7,F5) to the host.	None
Error	The value of PPGNT is not 0.	<ul style="list-style-type: none"> <li>• Changes the value of <i>_GEM_BusyEquipPPUpload</i> (Equipment-initiated Process Program Upload Transaction Processing Flag) to FALSE.</li> <li>• Stores the error information in <i>_GEM_EquipPPUploadRslt</i> (Equipment-initiated Process Program Upload Result).</li> </ul>	Yes

- 4** If the message is normal, the host connection function sends Process Program Request (S7,F5).

- 5** Process Program Data (S7,F6) is received from the host.

The value of *\_GEM\_BusyEquipPPUpload* (Equipment-initiated Process Program Upload Transaction Processing Flag) changes to FALSE.

The transaction processing result is stored in *\_GEM\_EquipPPUploadRslt* as the equipment-initiated process program upload result.

If the process program data can be received, the data received with Process Program Data (S7,F6) is stored in the PPBODY link variable for equipment-initiated upload.

● **Host-initiated Process Program Upload**

The following procedure is used for the Host-initiated Process Program Upload scenario.

- 1** Process Program Request (S7,F5) is received from the host.
- 2** The host connection function determines if the received primary message is normal.  
The normal/error results and factors, and the host connection function processing for each, are given in the following table. The table also tells if the user program is notified.

Result	Factor	Host connection function processing	Notifi- cation
Normal	---	Changes the value of <i>_GEM_BusyHostPPUpload</i> (Host-initiated Process Program Upload Transaction Processing Flag) to TRUE.	Yes
Error	The value of PPID is NULL.	Sends L,0 to the host with Process Program Data (S7,F6).	None
	The value of the <i>_GEM_Interlock_PP</i> interlock variable is TRUE.		
	Process programs in the Process Program Management GEM capability are disabled.		
	Common criteria*1	Common processing	

\*1. Refer to *When Host Sends the Primary Message* on page 5-7 for the common criteria and applicable processing.

The data received with Process Program Request (S7,F5) is stored in the *PPID of upload request* link variable for host-initiated upload.

- 3** The host connection function returns Process Program Data (S7,F6).  
To return Process Program Data (S7,F6), execute the Respond to Process Program Upload (GEM\_RespPPUpload) instruction in the user program. When you execute the instruction, store the send data for Process Program Data (S7,F6) in the PPBODY link variable for host-initiated upload.

● **Equipment-initiated Process Program Download**

The following procedure is used for the Equipment-initiated Process Program Download scenario.

- 1** The host connection function sends Process Program Request (S7,F5).  
To send Process Program Request (S7,F5), execute the Request Process Program Download (GEM\_RequestPPDownload) instruction in the user program.
- 2** Process Program Data (S7,F6) is received from the host.  
The value of *\_GEM\_BusyEquipPPDownload* (Equipment-initiated Process Program Download Transaction Processing Flag) changes to FALSE.  
The transaction processing result is stored in *\_GEM\_EquipPPDownloadRslt* as the equipment-initiated process program download result.  
The data received with Process Program Data (S7,F6) is stored in the PPID, LENGTH, and PPBODY link variables for equipment-initiated download.
- 3** The user program updates the PPID Management Table and process program.

### ● Host-initiated Process Program Download

The following procedure is used for the Host-initiated Process Program Download scenario.

- 1** Process Program Load Inquire (S7,F1) is received from the host.
- 2** The host connection function determines if the received primary message is normal.

The normal/error results and factors, and the host connection function processing for each, are given in the following table. The table also tells if the user program is notified.

Result	Factor	Host connection function processing		Notifi- cation
		Processing	Value of PPGNT	
Normal	---	Sends Process Program Load Grant (S7,F2) to the host.	0	None
Error	The PPID Management Table is full.		2	
	The value of PPID is NULL.		3	
	The value of the <i>_GEM_Interlock_PP</i> interlock variable is TRUE.		4	
	The value of LENGTH exceeds the permissible message length set on the SECS/GEM Configurator.		5	
	Process programs in the Process Program Management GEM capability are disabled.		60	
	Common criteria <sup>*1</sup>		Common processing	

\*1. Refer to *When Host Sends the Primary Message* on page 5-7 for the common criteria and applicable processing.

- 3** The host connection function returns Process Program Load Grant (S7,F2).
- 4** Process Program Send (S7,F3) is received from the host.



**5** The host connection function determines if the process program can be accepted. The accept/reject results and factors, and the host connection function processing for each, are given in the following table. The table also tells if the user program is notified.

Result	Factor	Host connection function processing		Notifi- cation
		Processing	Value of ACKC7	
Can be accepted	---	Changes the value of <code>_GEM_BusyHostPPDownload</code> (Host-initiated Process Program Download Transaction Processing Flag) to TRUE.	---	Yes
Cannot be accepted	The PPID Management Table is full.	Sends Process Program Acknowledge (S7,F4) to the host.	3	None
	The value of PPID is NULL.		4	
	The value of the <code>_GEM_Interlock_PP</code> interlock variable is TRUE.		5	
	Process programs in the Process Program Management GEM capability are disabled.		60	
	Common criteria <sup>*1</sup>		---	
	Common processing			

\*1. Refer to *When Host Sends the Primary Message* on page 5-7 for the common criteria and applicable processing.

The data received with Process Program Send (S7,F3) is stored in the PPID, LENGTH, and PPBODY link variables for host-initiated download.

**6** The user program updates the PPID Management Table and process program.

**7** The host connection function returns Process Program Acknowledge (S7,F4).

To send Process Program Acknowledge (S7,F4), execute the Acknowledge Process Program Download (`GEM_AckPPDownload`) instruction in the user program.

## ● Equipment-initiated Formatted Process Program Upload

The following procedure is used for the Equipment-initiated Formatted Process Program Upload scenario.

- 1** The host connection function sends Process Program Load Inquire (S7,F1).  
To send Process Program Load Inquire (S7,F1), execute the Upload Formatted Process Program (GEM\_UploadFormattedPP) instruction in the user program.
- 2** Process Program Load Grant (S7,F2) is received from the host.
- 3** The host connection function determines if the received secondary message is normal.  
The normal/error results and factors, and the host connection function processing for each, are given in the following table. The table also tells if the user program is notified.

Result	Factor	Host connection function processing	Notification
Normal	---	Sends Process Program Request (S7,F5) to the host.	None
Error	The value of PPGNT is not 0.	<ul style="list-style-type: none"> <li>• Changes the value of <code>_GEM_BusyEquipFormattedPPUpload</code> (Equipment-initiated Formatted Process Program Upload Transaction Processing Flag) to FALSE.</li> <li>• Stores the error information from the result of the equipment-initiated formatted process program upload in <code>_GEM_EquipFormattedPPUploadRslt</code>.</li> </ul>	Yes

- 4** If the message is normal, the host connection function sends Formatted Process Program Request (S7,F25).
- 5** Formatted Process Program Data (S7,F26) is received from the host.  
The value of `_GEM_BusyFormattedEquipPPUpload` (Formatted Process Program Upload Transaction Processing Flag) is changed to FALSE.  
The transaction processing result is stored in `_GEM_EquipPPUploadRslt` as the equipment-initiated formatted process program upload result.

If the formatted process program data can be received, the data received with Formatted Process Program Data (S7,F26) is stored in the *CCODE table* link variable for equipment-initiated formatted process program upload.

● **Host-initiated Formatted Process Program Upload**

The following procedure is used for the Host-initiated Formatted Process Program Upload scenario.

- 1** Formatted Process Program Request (S7,F25) is received from the host.
- 2** The host connection function determines if the received primary message is normal.

The normal/error results and factors, and the host connection function processing for each, are given in the following table. The table also tells if the user program is notified.

Result	Factor	Host connection function processing	Notifi- cation
Normal	---	Changes the value of <i>_GEM_BusyHostFormattedPPUpload</i> (Host-initiated Formatted Process Program Upload Transaction Processing Flag) to TRUE.	Yes
Error	The value of PPID is NULL.	Sends L,0 to the host with Formatted Process Program Data (S7,F26).	None
	The value of the <i>_GEM_Interlock_PP</i> interlock variable is TRUE.		
	Formatted process programs in the Process Program Management GEM capability are disabled.		
	Common criteria*1	Common processing	

\*1. Refer to *When Host Sends the Primary Message* on page 5-7 for the common criteria and applicable processing.

The data received with Formatted Process Program Request (S7,F25) is stored in the *PPID of upload request* link variable for host-initiated formatted process program upload.

- 3** The host connection function returns Formatted Process Program Data (S7,F26).

To return Formatted Process Program Data (S7,F26), execute the Respond to Formatted Process Program Upload (*GEM\_RespFormattedPPUpload*) instruction in the user program.

When you execute the instruction, store the send data for Formatted Process Program Data (S7,F26) in the *CCODE table* link variable for host-initiated formatted process program upload.

## ● Equipment-initiated Formatted Process Program Download

The following procedure is used for the Equipment-initiated Formatted Process Program Download scenario.

- 1** The host connection function sends Formatted Process Program Request (S7,F25).  
To send Formatted Process Program Request (S7,F25), execute the Request Formatted Process Program Download (GEM\_RequestFormattedPPDownload) instruction in the user program.
- 2** Formatted Process Program Data (S7,F26) is received from the host.  
The value of *\_GEM\_BusyEquipFormattedPPDownload* (Formatted Process Program Download Transaction Processing Flag) is changed to FALSE.  
The transaction processing result is stored in *\_GEM\_EquipFormattedPPDownloadRslt* as the equipment-initiated formatted process program download result.  
The data received with Formatted Process Program Data (S7,F26) is stored in the following link variables for equipment-initiated formatted process program download.
  - PPID
  - MDLN
  - SOFTREV
  - CCODE count
  - CCODE table
- 3** The user program updates the PPID Management Table and process program.
- 4** The host connection function sends Process Program Verification Send (S7,F27).  
To send Process Program Verification Send (S7,F27), execute the Send Process Program Verification Result (GEM\_SendPPVerify) instruction in the user program.  
When you execute the instruction, store the send data for Process Program Verification Send (S7,F27) in the *ACKC7A table*, *SEQNUM table*, and *ERRW7 table* link variables for verification check results.
- 5** Process Program Verification Acknowledge (S7,F28) is received from the host.

● **Host-initiated Formatted Process Program Download**

The following procedure is used for the Host-initiated Formatted Process Program Download scenario.

- 1** Process Program Load Inquire (S7,F1) is received from the host.
- 2** The host connection function determines if the received primary message is normal.  
The normal/error results and factors, and the host connection function processing for each, are given in the following table. The table also tells if the user program is notified.

Result	Factor	Host connection function processing		Notifi- cation
		Processing	Value of PPGNT	
Normal	---	Sends Process Program Load Grant (S7,F2) to the host.	0	None
Error	The PPID Management Table is full.		2	
	The value of PPID is NULL.		3	
	The value of the <i>_GEM_Interlock_PP</i> interlock variable is TRUE.		4	
	The value of LENGTH exceeds the permissible message length set on the SECS/GEM Configurator.		5	
	Formatted process programs in the Process Program Management GEM capability are disabled.		60	
	Common criteria <sup>*1</sup>		Common processing	

\*1. Refer to *When Host Sends the Primary Message* on page 5-7 for the common criteria and applicable processing.

- 3** If the message is normal, the host returns Process Program Load Grant (S7,F2).
- 4** Formatted Process Program Send (S7,F23) is received from the host.
- 5** The host connection function determines if the formatted process program can be accepted.  
If possible, the data received with Formatted Process Program Send (S7,F23) is stored in the following link variables for host-initiated formatted process program download.
  - PPID
  - MDLN
  - SOFTREV
  - CCODE count
  - CCODE table

The accept/reject results and factors, and the host connection function processing for each, are given in the following table. The table also tells if the user program is notified.

Result	Factor	Host connection function processing		Notification
		Processing	Value of ACKC7	
Can be accepted	---	Changes the value of <i>_GEM_BusyHostFormattedPPDownload</i> (Host-initiated Formatted Process Program Download Transaction Processing Flag) to TRUE.	---	Yes
Cannot be accepted	<ul style="list-style-type: none"> <li>The CCODE is not registered.</li> <li>The format of PPARM does not agree with the definition.</li> <li>The value of PPARM is 0.</li> <li>The number of PPARMs is larger than the maximum value of PPARM.</li> </ul>	Sends Formatted Process Program Acknowledge (S7,F24) to the host.	1	None
	The PPID Management Table is full.		3	
	The value of PPID is NULL.		4	
	The value of the <i>_GEM_Interlock_PP</i> interlock variable is TRUE.		5	
	Formatted process programs in the Process Program Management GEM capability are disabled.		60	
	Common criteria*1		Common processing	

\*1. Refer to *When Host Sends the Primary Message* on page 5-7 for the common criteria and applicable processing.

- 6** The user program updates the PPID Management Table and process program.
- 7** The host connection function returns Formatted Process Program Acknowledge (S7,F24).  
To return Formatted Process Program Acknowledge (S7,F24), execute the Acknowledge Formatted Process Program Download (GEM\_AckFormattedPPDownload) instruction in the user program.
- 8** The host connection function sends Process Program Verification Send (S7,F27).  
To send Process Program Verification Send (S7,F27), execute the Send Process Program Verification Result (GEM\_SendPPVerify) instruction in the user program.  
When you execute the instruction, store the send data for Process Program Verification Send (S7,F27) in the *ACKC7A table*, *SEQNUM table*, and *ERRW7 table* link variables for verification check results.
- 9** Process Program Verification Acknowledge (S7,F28) is received from the host.

## 5-5-16 Material Movement

Material movement is based on the Material Movement additional GEM capability.

The design items required to achieve this function are given in the following table along with references.

Item	Requirement	Reference
Setting with the SECS/GEM Configurator	Required.	5-5-4 Event Notification on page 5-40
Creating the user program on the Sysmac Studio	Required.	

### Material Movement

Collective events can be issued for material movement and the user program can manage receiving and removing materials based on the Material Movement additional GEM capability.

Receiving and removing materials from the equipment port are detected and Material Removed and Material Received collection events are issued to notify the host.

To issue a collection event, the CEID of the Material Removed or Material Received collection event is specified and the GEM\_ReportEvent instruction is executed in the user program.

### 5-5-17 Equipment Terminal Service

The equipment terminal service is based on the Equipment Terminal Service additional GEM capability.

The design items required to achieve this function are given in the following table along with references.

Item	Requirement	Reference
Settings on the SECS/GEM Configurator	Required.	8-11-7 <i>Equipment Terminal Service</i> on page 8-90
Creating the user program on the Sysmac Studio	Required.	This section

### Equipment Terminal Service

The host can collect information that is displayed on equipment displays based on the Equipment Terminal Service additional GEM capability. The equipment can also send information to the host. You can set TID to 0 to specify the main terminal and to 1 to specify an additional terminal as the equipment terminal. An additional terminal does not need to be used.

The main specifications of the equipment terminal service are given in the following table.

Item	Specification
Maximum size of terminal message [bytes] <sup>*1</sup>	240

\*1. The terminal message size is set as the data size of TEXT in the item definitions.



## Equipment Terminal Service Scenarios

There are the following two Equipment Terminal Service scenarios.

- Host Sends Information to Equipment Display Device
- Operator Sends Information to Host

### ● Host Sends Information to Equipment Display Device, Single Block

The following procedure is used for the Host Sends Information to Equipment Display Device, Single Block scenario.

- 1** The host sends Terminal Display, Single (S10,F3).
- 2** The host connection function determines if the received primary message is normal.

The normal/error results and factors, and the host connection function processing for each, are given in the following table. The table also tells if the user program is notified.

Result	Factor	Host connection function processing		Notification
		Processing	Value of ACKC10	
Normal	---	Changes the value of <code>_GEM_BusyHostTerminalMsgSB</code> (Host-initiated Single-block Terminal Message Transaction Processing Flag) to TRUE.	---	Yes
Error	The value of TID is incorrect.	Sends Terminal Display, Single Acknowledge (S10,F4) to the host.	2	None
	Common criteria <sup>*1</sup>	Common processing	---	

\*1. Refer to *When Host Sends the Primary Message* on page 5-7 for the common criteria and applicable processing.

- 3** The host connection function returns Terminal Display, Single Acknowledge (S10,F4).  
To send Terminal Display, Single Acknowledge (S10,F4), execute the Acknowledge Single-block Equipment Terminal Message (`GEM_AckTerminalMsgSB`) instruction in the user program.
- 4** The user displays the information on the specified terminal.  
If a Message Recognition collection event is issued when the operator checks the terminal message, the Report Event (`GEM_ReportEvent`) instruction is executed in the user program.

### ● Host Sends Information to Equipment Display Device, Multi-block

The following procedure is used for the Host Sends Information to Equipment Display Device, Multi-block scenario.

- 1** The host sends Terminal Display, Multi-block (S10,F5).
- 2** The host connection function determines if the received primary message is normal.

The normal/error results and factors, and the host connection function processing for each, are given in the following table. The table also tells if the user program is notified.

Result	Factor	Host connection function processing		Notification
		Processing	Value of ACKC10	
Normal	---	Changes the value of <code>_GEM_BusyHostTerminalMsgMB</code> (Host-initiated Multi-block Terminal Message Transaction Processing Flag) to TRUE.	---	Yes
Error	The value of TID is incorrect.	Sends Terminal Display, Multi-block (S10,F5) to the host.	2	None
	The TEXT count exceeds the set number of terminal messages displayed on a terminal.	<ul style="list-style-type: none"> <li>• Sends Terminal Display, Multi-block (S10,F5) to the host.</li> <li>• Sends Multi-block Not Allowed (S10,F7) to the host.</li> </ul>	63	
	Common criteria <sup>*1</sup>	Common processing	---	

\*1. Refer to *When Host Sends the Primary Message* on page 5-7 for the common criteria and applicable processing.

- 3** The host connection function returns Terminal Display, Multi-block Acknowledge (S10,F6).  
To send Terminal Display, Multi-block Acknowledge (S10,F6), execute the Acknowledge Multi-block Equipment Terminal Message (`GEM_AckTerminalMsgMB`) instruction in the user program.
- 4** The user displays the the information on the specified terminal.  
If a Message Recognition collection event is issued when the operator checks the terminal message, the Report Event (`GEM_ReportEvent`) instruction is executed in the user program.

### ● Operator Sends Information to Host

The following procedure is used for the Operator Sends Information to Host scenario.

- 1** The user executes the Send Equipment Terminal Message (`GEM_SendTerminalMsg`) instruction.
- 2** The host connection function sends Terminal Request (S10,F1).
- 3** The host sends Terminal Request Acknowledge (S10,F2).

## 5-5-18 Clock

The clock is based on the Clock additional GEM capability.

The design items required to achieve this function are given in the following table along with references.

Item	Requirement	Reference
Setting with the SECS/GEM Configurator	Not required.	---
Creating the user program on the Sysmac Studio	Required.	This section

### Clock

The equipment can request clock information from the host based on the Clock additional GEM capability. Also, the host can set the clock in the Controller.

### Clock Scenarios

There are the following two Clock scenarios.

- Equipment Requests Time
- Host Instructs Equipment to Set Time

#### ● Equipment Requests Time

The following procedure is used for the Equipment Requests Time scenario.

- 1** The user executes the Request Time Change (GEM\_RequestChangeTime) instruction.
- 2** The host connection function sends Date and Time Request (S2,F17).
- 3** The host sends Date and Time Data (S2,F18).
- 4** The date and time are set in the equipment.
- 5** The equipment-initiated time change result is set in *\_GEM\_EquipChangeTimeRslt*.

If TIME in Date and Time Data (S2,F18) is not a 12-byte or 16-byte text string, the date and time in the equipment are not changed.

## ● Host Instructs Equipment to Set Time

The following procedure is used for the Host Instructs Equipment to Set Time scenario. The host connection function performs all of the processing for the Host Instructs Equipment to Set Time scenario. Reception of the primary message is not reported to the user program.

- 1** The host sends Date and Time Set Request (S2,F31).
- 2** The host connection function determines if the received primary message is normal.

The normal/error results and factors, and the host connection function processing for each, are given in the following table. The table also tells if the user program is notified.

Result	Factor	Host connection function processing		Notification
		Processing	Value of TIACK	
Normal	---	<ul style="list-style-type: none"> <li>• Sends Date and Time Acknowledge (S2,F32) to the host.</li> <li>• Sets the date and time in the equipment.</li> </ul>	0	None
Error	The value of TIME is not a date and time.	Sends Date and Time Acknowledge (S2,F32) to the host.	1	
	The value of the <code>_GEM_Interlock_Time</code> interlock variable is TRUE.		63	
	Common criteria <sup>*2*3</sup>	Common processing	---	

\*1. Regardless of the value of the *TimeFormat* equipment constant, the value of a 12-byte or 16-byte TIME is accepted.

\*2. Refer to *When Host Sends the Primary Message* on page 5-7 for the common criteria and applicable processing.

\*3. If TIME is not a 12-byte or 16-byte text string, Illegal Data (S9,F7) is returned to the host.

- 3** The host connection function returns Date and Time Acknowledge (S2,F32).

## **\_GEM\_Interlock\_Time** Interlock Variable

The `_GEM_Interlock_Time` interlock variable is related to the clock.

The relationship between the Clock scenarios and the SECS messages that are interlocked is given in the following table.

Scenario	Interlocked SECS message
Equipment Requests Time	None
Host Instructs Equipment to Set Time	Date and Time Set Request (S2,F31)

## 5-5-19 Limit Monitoring

Limit monitoring is based on the Limits Monitoring additional GEM capability.

The design items required to achieve this function are given in the following table along with references.

Item	Requirement	Reference
Settings on the SECS/GEM Configurator	Required.	8-9-3 <i>Status Variable (SV)</i> on page 8-50 8-11-8 <i>Limit Monitoring</i> on page 8-92
Creating the user program on the Sysmac Studio	Not required.	---

### Limit Monitoring

The host can monitor the values of status variables based on the Limits Monitoring additional GEM capability. The host connection function manages state transitions for limit monitoring. You do not need to manage state transitions for limit monitoring.

The main specifications of limit monitoring are given in the following table.

Item	Specification
Maximum number of status variables for limit monitoring	5
Maximum number of limit settings registered for one status variable	7
Sampling period [s]	1 to 360

You cannot specify the following formats for limit monitoring.

- List (L)
- ASCII (A)
- Binary (B)
- Numeric formats with more than one element (U1, U2, U4, F4, F8, I1, I2, and I4)

### Limit Monitoring Scenarios

There are the following three Limit Monitoring scenarios.

- Zone Transition Event Occurs in Equipment
- Host Defines Limit Attribute
- Host Queries Equipment for Current Limits

#### ● Zone Transition Event Occurs in Equipment

When a status variable that is specified for limit monitoring moves between monitoring zones, a Limit Zone Transition collection event is sent to the host.

### ● Host Defines Limit Attribute

The following procedure is used for the Host Defines Limit Attribute scenario.

- 1** The host sends Define Variable Limit Attributes (S2,F45).
- 2** The host connection function determines if the received primary message is normal.

The normal/error results and factors, and the host connection function processing for each, are given in the following table. The table also tells if the user program is notified.

Result	Factor	Host connection function processing		Notification
		Processing	Value of VLAACK	
Normal	---	Sends Date and Time	0	None
Error	There is an error in a limit attribute. *1	Set Acknowledge (S2,F32) to the host.	1	
	More than five status variables are specified for limit monitoring at the same time.		2	
	Common criteria *2	Common processing	---	

\*1. A limit attribute error is reflected in the values of LVACK and LIMITACK. Refer to the following tables for details on determining limit attribute errors.

\*2. Refer to *When Host Sends the Primary Message* on page 5-7 for the common criteria and applicable processing.

A limit attribute error is reflected in the values of LVACK and LIMITACK. The meanings of the values of LVACK and LIMITACK are given in the following tables..

Value of LVACK	Meaning
1	VID is not registered.
2	VID is not a target for limit monitoring.
3	The same VID was used twice.
4	The value of LIMITID, UPPERDB, or LOWERDB is not correct.
63	The same VID is used more than seven times in the limit settings.

Value of LIMITACK	Meaning
2	The value of UPPERDB is greater than the value of LIMITMAX.
3	The value of LOWERDB is smaller than the value of LIMITMIN.
4	The value of UPPERDB is smaller than the value of LOWERDB.
7	The same LIMITID is used twice.

- 3** The host connection function returns Variable Limit Attribute Acknowledge (S2,F46).

### ● Host Queries Equipment for Current Limits

The following procedure is used for the Host Queries Equipment for Current Limits scenario.

- 1** The host sends Variable Limit Attribute Request (S2,F47).
- 2** The host connection function returns Variable Limit Attributes Send (S2,F48).

## Limit State Model

The variables for which limits are monitored operate according to the following limit state model.

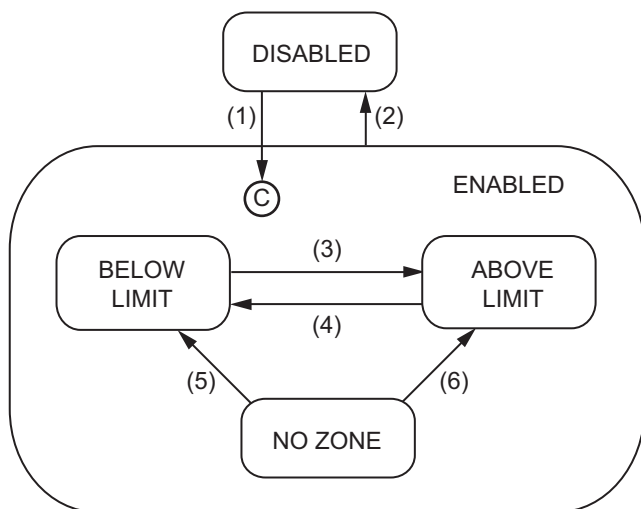

The triggers, resulting equipment operation, and comments for the above transitions are described in the following table. The numbers in the table correspond to the numbers in the figure.

No.	Current state	Trigger	New state	Operation	Comment
(1)	DISABLED	Limit attribute defined with Define Variable Limit Attributes (S2,F45)	ENABLED	None	The substate of ENABLED is determined by the value of the monitored variable.
(2)	ENABLED	Limit attribute undefined with Define Variable Limit Attributes (S2,F45)	DISABLED	None	---
(3)	BELOW LIMIT	Variable increased to be $\geq$ UPPERDB (upper boundary of the deadband)	ABOVE LIMIT	None	A Limit Zone Transition collection event is issued.
(4)	ABOVE LIMIT	Variable decreased to be $\leq$ LOWERDB (lower boundary of the deadband)	BELOW LIMIT	None	A Limit Zone Transition collection event is issued.
(5)	NO ZONE	Variable decreased to be $\leq$ LOWERDB (lower boundary of the deadband)	BELOW LIMIT	None	---
(6)	NO ZONE	Variable increased to be $\geq$ UPPERDB (upper boundary of the deadband)	ABOVE LIMIT	None	---

## 5-5-20 Spooling

Spooling is based on the Spooling additional GEM capability.

The design items required to achieve this function are given in the following table along with references.

Item	Requirement	Reference
Setting with the SECS/GEM Configurator	Required.	8-11-9 Spooling on page 8-93
Creating the user program on the Sysmac Studio	Not required.	---

### Spooling

While communications are cut off between the host and equipment, the SECS messages to send from the equipment to the host can be queued based on the Spooling additional GEM capability. Then, when communications recover, the queued SECS messages can be sent from the equipment to the host.

The host connection function manages state transitions for spooling. You do not need to manage state transitions for spooling.

You can spool the SECS messages only for the primary messages in the user-specified streams.

The main specifications of the spooling are given in the following table.

Item	Specification
Maximum number of messages that can be spooled	1000

The spooled SECS messages are saved in the SD Memory Card. The saved SECS messages are discarded in the following cases.

- Request Spooled Data (S6,F23) is received from the host with RSDC set to 1.
- The spooling settings are changed from the SECS/GEM Configurator.
- Restoring backup data is performed for the Controller
- An SD Memory Card was inserted when the GEM Service status is Run.
- The SD Memory Card is initialized with a Sysmac Studio operation.
- An error occurs in the spooled data stored on the SD Memory Card.





### Precautions for Correct Use

- When the equipment sends queued primary messages to the host with spooling, the transaction processing is not performed for the secondary message from the host.
- If spooling is enabled for the following SECS messages, transaction processing will end in a send error when the message is spooled. When a send error occurs, the value of the *Rslt-Code* member of the system-defined variable for the processing result will be 16#0100.
  - Process Program Load Inquire (S7,F1)
  - Process Program Send (S7,F3)
  - Process Program Request (S7,F5)
  - Formatted Process Program Send (S7,F23)
  - Formatted Process Program Request (S7,F25)
  - Process Program Verification Send (S7,F27)
  - Terminal Request (S10,F1)
- If you set spooling for user-defined messages, the user program is not notified when the secondary message is received from the host.
- Immediately after communications are interrupted, e.g., by a disconnected cable, the SECS message sent from the equipment to the host may not be spooled.

## Spooling Scenarios

There are the following two Spooling scenarios.

- Define Set of Messages to Spool
- Request or Delete Spooled Data

### ● Define Set of Messages to Spool

The following procedure is used for the Define Set of Messages to Spool scenario.

- 1** The host sends Reset Spooling Streams and Functions (S2,F43).
- 2** The host connection function determines if the received primary message is normal.

The normal/error results and factors, and the host connection function processing for each, are given in the following table. The table also tells if the user program is notified.

Result	Factor	Host connection function processing		Notification
		Processing	Value of RSPACK	
Normal	---	Sends Reset Spooling Acknowledge (S2,F44) to the host.	0	None
Error	The spooling state is SPOOL ACTIVE.		1	
	The spool data is not saved.		2	
	Common criteria*1	Common processing	---	

\*1. Refer to *When Host Sends the Primary Message* on page 5-7 for the common criteria and applicable processing.

- 3** The host connection function returns Reset Spooling Acknowledge (S2,F44).

### ● Request or Delete Spooled Data

The following procedure is used for the Request or Delete Spooled Data scenario.

- 1** The host sends Request Spooled Data (S6,F23).
- 2** The host connection function determines if the received primary message is normal.

The normal/error results and factors, and the host connection function processing for each, are given in the following table. The table also tells if the user program is notified.

Result	Factor	Host connection function processing		Notification
		Processing	Value of RSDA	
Normal	---	Sends Request Spooled Data Acknowledgement Send (S6,F24) to the host.	0	None
Error	The host sent Request Spooled Data (S6,F23) during spooled data transfer.	Sends Request Spooled Data Acknowledgement Send (S6,F24) to the host.	1	
	There is no spooled data.		2	
	The value of RSDC is not correct.		63	
	Common criteria <sup>*1</sup>		Common processing	

\*1. Refer to *When Host Sends the Primary Message* on page 5-7 for the common criteria and applicable processing.

- 3** The host connection function performs the following processing according to the value of RSDC if the received primary message is normal.

Value of RSDC	Host connection function processing
0	Sends a spool message to the host.
1	Discards the spooled data.

- 4** The host connection function returns Request Spooled Data Acknowledgement Send (S6,F24).

## Spooling State Model

State transitions for spooling are performed according to the following spooling state model. If the GEM Service status is not EQRun, the spooling state is always FUNCTION OFF.

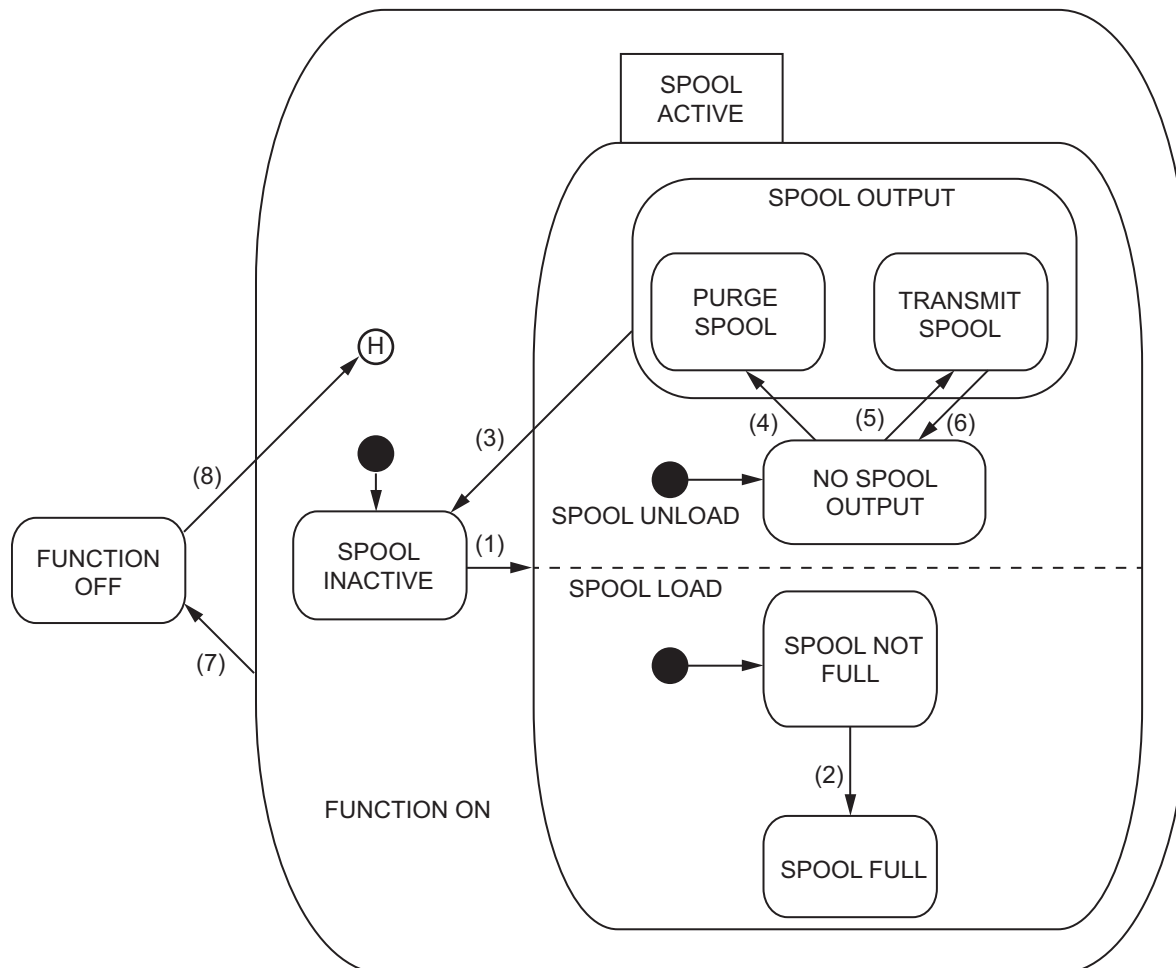

The triggers, resulting equipment operation, and comments for the above transitions are described in the following table. The numbers in the table correspond to the numbers in the figure.

No.	Current state	Trigger	New state	Operation	Comment
(1)	SPOOL INACTIVE	The communications state changes from COMMUNICATING to NOT COMMUNICATIONS or from WAIT CRA to WAIT DELAY and <i>EnableSpool</i> is TRUE.	SPOOL ACTIVE	<i>SpoolCountActual</i> and <i>SpoolCountTotal</i> are initialized to zero. Any open transactions with the host are aborted. <i>SpoolStartTime</i> is set to the current time.	A Spooling Activated collection event is issued.
(2)	SPOOL NOT FULL	Message generated does not fit into spool area.	SPOOL FULL	<i>SpoolFullTime</i> is set to the current time.	---
(3)	SPOOL OUTPUT	<ul style="list-style-type: none"> <li>Spool area became empty.</li> <li>The SD Memory Card was removed.</li> </ul>	SPOOL INACTIVE	Spooling processing is disabled.	A Spooling Deactivated collection event is issued.
(4)	NO SPOOL OUTPUT	Request Spooled Data (S6,F23) was received with RSDC set to 1.	PURGE SPOOL	None	Purging is started.
(5)	NO SPOOL OUTPUT	Request Spooled Data (S6,F23) was received with RSDC set to 0.	TRANSMIT SPOOL	None	Sending SECS messages from the spool is started.
(6)	TRANSMIT SPOOL	Communications failed or <i>MaxSpoolTransmit</i> was reached.	NO SPOOL OUTPUT	Spool transmission processing is suspended.	If communications fail, a Spool Transmit Failure collection event is issued.
(7)	FUNCTION ON	The GEM Service status changed to a status other than EQRun.	FUNCTION OFF	None	The spooling context is saved in non-volatile memory.
(8)	FUNCTION OFF	The GEM Service status changed to EQRun.	FUNCTION ON	The spooling context is restored from non-volatile memory.	If spooling was active before the power supply was turned OFF, the active state is continued. Transition 6 occurs if the state TRANSMIT SPOOL was active when power went down.

## Spooling Settings

Some spooling settings are made from the SECS/GEM Configurator and others are made from the user program.

- **Settings Made from the SECS/GEM Configurator**

The number of spooled messages and the messages to spool are set with the SECS/GEM Configurator. Refer to *8-11-9 Spooling* on page 8-93 for details.

- **Settings Made with the User Program**

The Change Equipment Constant (GEM\_ChangeECV) instruction is used to set the values of equipment constants related to spooling.

## System-defined Variables Related to Spooling

The following system-defined variables are related to spooling. Refer to *A-2 System-defined Variables* on page A-211 for details on system-defined variables.

System-defined variable	Name
_GEM_SpoolParam	Spooling Parameters
_GEM_SpoolCondition	Spool Information
_GEM_SpoolingState	Spooling State

## 5-6 Message Settings

You can make message settings for the following two types of SECS messages.

- GEM Standard Messages: These are the SECS messages that are supported as standard features by the GEM Services.
- User-defined Messages: These are SECS messages that are defined by the user.

### 5-6-1 GEM Standard Messages

The following settings are made from the SECS/GEM Configurator for the SECS messages that are supported as standard features by the GEM Services.

Item	Set value	Meaning
Setting to enable/disable primary messages from the host to the equipment	Enabled	Primary messages from the host to the equipment are enabled.
	Disabled	Primary messages from the host to the equipment are disabled.
W-bit setting for primary messages sent from the equipment to the host	ON	Indicates a primary message that requires a response from the host to the equipment.
	OFF	Indicates a primary message that does not require a response from the host to the equipment.

Refer to *8-12-1 GEM Standard Messages* on page 8-95 for the procedures to make the settings for GEM standard messages on the SECS/GEM Configurator.

## Processing Differences Based on the Settings

The processing performed by the equipment when it receives a SECS message from the host depends on the primary message enable/disable setting and the W-bit setting for GEM standard messages.

The processing performed by the equipment also depends on whether the SECS message is processed just by the GEM Services or it is processed jointly by the GEM Services and user program.

### ● Host Sends Primary Message to Equipment

When the host sends a primary message to the equipment, the following reception processing is performed by the equipment according to the setting.

Enable/disable setting	Host connection function processing	User program processing
Enabled	Depends on the SECS message. *1	
Disabled	Sends Unrecognized Function Type (S9,F5) to the host.	Processing is performed only by the host connection function.

\*1. Refer to 2-3-1 *SECS Messages When Host Sends the Primary Message* on page 2-7 for details.



### Precautions for Correct Use

If the W bit in a primary message from the host is OFF, the equipment sends Unrecognized Function Type (S9,F5) regardless of the primary message enable/disable setting.

### ● Equipment Sends Primary Message to Host

When the equipment sends a primary message to the host and the host sends a secondary message to the equipment, the following reception processing is performed by the equipment according to the setting.

W-bit setting	Host connection function processing	User program processing
ON	Depends on the SECS message. *1	
OFF	Sends Unrecognized Function Type (S9,F5) to the host.	Processing is performed only by the host connection function.

\*1. Refer to 2-3-2 *SECS Messages When Equipment Sends the Primary Message* on page 2-11 for details.

## 5-6-2 User-defined Messages

In addition to the SECS messages defined in the SECS/GEM standard, the user can define any SECS messages that are compliant with SECS. These are called user-defined messages.

The specifications for user-defined messages are given in the following table.

Item	Specification
Maximum number of registered user-defined messages	128
Maximum number of registered SECS messages with the same function number and stream number	20
Maximum size of SECS message [Kbytes]	256
Maximum number of items registered in one SECS message	160

User-defined messages are defined in pairs. Each pair consists of a primary message and a secondary message. The stream and function numbers for a primary message and secondary message pair are in the form  $SxFy$  and  $SxFy+1$ . Here,  $y$  is an odd number. However, if the  $W$  bit for a primary message is set to OFF, a secondary message is not required for it.

Refer to *8-12-2 User-defined Messages* on page 8-96 for the procedures to make the settings for user-defined messages on the SECS/GEM Configurator.



### Precautions for Correct Use

- You cannot define a SECS message that has the same stream and function numbers as a SECS standard message.
- It is not necessary to register the  $Sx,F0$  message. If the control state is EQUIPMENT OFF-LINE, the GEM services will return the  $Sx,F0$  message.
- If you define more than one SECS message with the same message structure, the SECS message with the smaller message number takes priority.

## Message Structure and Link Variables

The item and list formats that you can use in user-defined messages are given in the following table.

Item	Format
Items	B, BOOLEAN, A, I1, I2, I4, F4, F8, U1, U2, and U4
Lists	Lists of fixed length data and lists of length-variable data

You use the SECS/GEM Configurator to assign a link variable to each message item. The data type of a link variable depends on the item format and message list structure.



## List Specifications for User-defined Messages

There are two types of lists: lists of fixed length data and lists of length-variable data. Also, you can nest lists. You can nest lists within lists. You can create a total of up to six nesting levels for lists of fixed length data and lists of length-variable data. You cannot nest a list of length-variable data inside a list of length-variable data.

### List of Fixed Length Data

For the list of fixed length data, you set the items for each list. You can set a different format for each item in a list. The specifications for a list of fixed length data are given in the following table.

Item	Specification
Number of lists	0 to 128

In a list of fixed length data, a link variable is assigned to store the value separately for each item in the list.

The following example shows a message structure on the SECS/GEM Configurator for a list of fixed length data with three nesting levels and link variables assigned for each item.

Number of lists    Item name    Link variable assigned to item

Message structure

```

L,4
  1.B Item1
  2.U1 Item2
  3.U2 Item3
  4.L,2
    1.B Item4
    2.L,2
      1.I1 Item5
      2.I2 Item6
  
```

Structure	Link variable
1.<E Item1>	SxFy_00001_Item1
2.<U1 Item2>	SxFy_00001_Item2
3.<U2 Item3>	SxFy_00001_Item3
4.L,2	
1.<B Item4>	SxFy_00001_Item4
2.L,2	
1.<I1 Item5>	S1F100_00001_Item5
2.<I2 Item6>	SxFy_00001_Item6

### List of Length-variable Data

For the list of length-variable data, you set items to be changeable. All items in the list have the same format. The specifications for a list of length-variable data are given in the following table.

Item	Specification
Number of lists	1 to 128

For a list of length-variable data, a link variable to store the number of items and a shared array link variable to store the item values are assigned. The number of array elements must be equal to the maximum number of items.

The following example shows a message structure on the SECS/GEM Configurator for an item in the list of length-variable data and link variables assignments. The variable *SxFy\_00002\_List1* stores the number of items in the list of length-variable data, and the variable *SxFy\_00002\_Item1* stores the values of the items. The data type of *SxFy\_00002\_Item1* is *ARRAY[0..4] OF INT*.

The data type is *ARRAY[0..4] OF INT.*

Message structure  
L,n (Max. value of n: 5)  
1.I2 Item1  
2.I2 Item2  
:  
n.I2 Itemn

Structure	Link variable
Ln1 (5)	SxFy_00002_List1
1.<I2 Item1>	SxFy_00002_Item1

## User-defined Message Processing

Processing of user-defined messages is different depending on whether the host sends the primary message to the equipment or the equipment sends the primary message to the host.

### ● Host Sends Primary Message to Equipment

The following procedure is used when the host sends the primary message to the equipment.

- 1 The host sends the primary message to the equipment.
- 2 The host connection function determines if the received primary message is normal.

The normal/error results and factors, and the host connection function processing for each, are given in the following table. The table also tells if the user program is notified.

Result	Factor	Host connection function processing	Notification
Normal	---	Changes the value of <code>_GEM_BusyHostUserMsg</code> (Host-initiated User-defined Message Transaction Processing Flag) to TRUE.	Yes
Error	Common criteria*1	Common processing	None

\*1. Refer to *When Host Sends the Primary Message* on page 5-7 for the common criteria and applicable processing.

- 3 The user executes the Respond to Host-initiated User-defined Message (`GEM_RespHostUserMsg`) instruction in the user program.

The message number that is specified in the `GEM_RespHostUseMsg` instruction depends on the W-bit setting in the primary message as described in the following table.

Primary message W-bit setting	Message number
ON	Message number defined for <code>SxFy+1</code> in response to a primary message with stream and function numbers of <code>SxFy</code> .
OFF	0

- 4 The equipment returns the secondary message to the host.

## ● Equipment Sends Primary Message to Host

The following procedure is used when the equipment sends the primary message to the host.

Refer to *System-defined Variables* on page A-211 for details on the system-defined variables that are given. Refer to *GEM\_SendEquipUserMsg* on page A-175 for details on the *GEM\_SendEquipUserMsg* instruction.

- 1** The user executes the Send Equipment-initiated User-defined Message (*GEM\_SendEquipUserMsg*) instruction in the user program.
- 2** The equipment sends the primary message to the host.
- 3** The host sends the secondary message to the equipment.
- 4** The host connection function determines if the received secondary message is normal. If there is an error, it changes the value of *\_GEM\_BusyEquipUserMsg* (Equipment-initiated User-defined Message Transaction Processing Flag) to FALSE. It also stores the transaction processing result in *\_GEM\_EquipUserMsgRslt* as the equipment-initiated user-defined message result.

The secondary message error criteria and the host connection function processing for each are given in the following table. The table also tells if the user program is notified of reception of the secondary message.

Error criteria	Host connection function processing	Notification
A secondary message with normal stream and function numbers was received, but the message structure of the received message is different from the structure set on the SECS/GEM Configurator.	An error is given for the transaction processing result.	Yes <sup>*1</sup>
A secondary message with stream and function numbers that are not correct was received, and the message structure of the received message is different from the structure set on the SECS/GEM Configurator.	<ul style="list-style-type: none"> <li>• The secondary message is discarded.</li> <li>• Illegal Data (S9,F7) is sent to the host.</li> </ul>	None
The W-bit setting in the primary message is ON but a secondary message was not sent.	<p>The following processing is performed after a T3 timeout.</p> <ul style="list-style-type: none"> <li>• An error is given for the transaction processing result.</li> <li>• Transaction Timer Timeout (S9,F9) is sent to the host.</li> </ul>	Yes <sup>*1</sup>

\*1. You can check to see if a secondary message was received with the value of *\_GEM\_BusyEquipUserMsg*.

If the W-bit setting in the primary message is OFF, the value of *\_GEM\_BusyEquipUserMsg* changes to FALSE before the secondary message is received from the host.

# 6

## GEM Service Logs

The GEM Service logs record the operations that were performed by the GEM Services. You use the Log Viewer in the GEM Setting Tools to view the contents of the logs. This section provides details on the GEM Service logs and the operating procedures for the Log Viewer.

---

<b>6-1</b>	<b>GEM Service Logs</b>	<b>6-2</b>
6-1-1	Types of GEM Service Logs	6-2
6-1-2	Saving Destinations for GEM Service Logs	6-2
6-1-3	Restrictions on GEM Service Logs	6-2
<b>6-2</b>	<b>Application Procedures for the GEM Service Logs</b>	<b>6-4</b>
6-2-1	Setting the Numbers of Records Saved in the GEM Service Logs	6-4
6-2-2	Displaying the Contents of the GEM Service Logs	6-4
<b>6-3</b>	<b>Log Viewer Operations</b>	<b>6-6</b>
6-3-1	Installation of GEM Setting Tools	6-6
6-3-2	Starting and Stopping the Log Viewer	6-6
6-3-3	Configuration of the Main Window	6-7
6-3-4	Procedure to Display a GEM Service Log	6-8
6-3-5	Displaying the SECS Message Log	6-12
6-3-6	Displaying the HSMS Communications Log	6-15
6-3-7	Displaying the Execution Log	6-17
6-3-8	Filters	6-18
6-3-9	Saving the Current Settings	6-18
6-3-10	Outputting Logs to Files	6-19
6-3-11	Windows	6-22
6-3-12	Help	6-22

## 6-1 GEM Service Logs

The GEM Service logs record the operations that were performed by the GEM Services. This section describes the types of GEM Service logs, where they are saved, and the restrictions that apply to them.

### 6-1-1 Types of GEM Service Logs

There are the following three types of GEM Service logs. The log contents, application methods, and numbers of saved records for the GEM Service logs are given in the following table. You can set the numbers of records that are saved with **Configuration – GEM Service Log** on the List Menu of the SECS/GEM Configurator.

Types of GEM Service Logs	Recorded contents	Application methods	Number of saved records*1
SECS message log	SECS messages sent between the host and equipment	<ul style="list-style-type: none"> <li>• Debugging communications between the host and equipment</li> <li>• Evidence that the equipment to which the SECS/GEM CPU Unit is mounted complies with GEM capability definitions</li> </ul>	0-1,000,000
HSMS communications log	Operating status for HSMS communications	Troubleshooting errors that occur in the physical layer	0-100,000
Execution log	GEM instruction execution and transaction processing values	Evidence that the GEM Services are operating	0-100,000

\*1. You can make the settings in increments of 100 records. Records are not recorded in the logs if you set 0.

### 6-1-2 Saving Destinations for GEM Service Logs

The GEM Service logs are saved on the SD Memory Card. The logs are saved in the following directories.

GEM Service log	Directory name
SECS message log	/packages/GEM/log/secs
HSMS communications log	/packages/GEM/log/hsms
Execution log	/packages/GEM/log/execution

### 6-1-3 Restrictions on GEM Service Logs

The following restrictions apply to the GEM Service logs.

#### Conditions Under Which Records Cannot Be Logged in GEM Service Logs

Records cannot be logged in the GEM Service logs in the following cases.

- There is no SD Memory Card inserted in the CPU Unit.
- The SD Memory Card does not have enough available space.
- The SECS/GEM Configurator was used to disable saving to the GEM Service logs.
- The SD Memory Card is write protected.
- Writing to the SD Memory Card is not possible, e.g., the SD Memory Card is faulty.

## Conditions Under Which GEM Service Log Files Are Deleted

---

The GEM Service log files are deleted in the following cases.

- Any of the settings of the numbers of records saved in the GEM Service logs was changed from the SECS/GEM Configurator.
- The SD Memory Card was initialized from the Sysmac Studio.
- The log file contents that was set with the SECS/GEM Configurator does not agree with the actual contents of the SD Memory Card.

## 6-2 Application Procedures for the GEM Service Logs

The following two processes are used for the GEM Service logs.

- The numbers of records to save in the GEM Service logs are set before the Controller is operated.
- The contents of the GEM Service logs is checked after the Controller is operated.

### 6-2-1 Setting the Numbers of Records Saved in the GEM Service Logs

You set the numbers of records to save in the GEM Service logs with **Configuration – GEM Service Log** on the List Menu of the SECS/GEM Configurator. Refer to *8-7-1 GEM Service Log* on page 8-42 for a detailed setting procedure.

### 6-2-2 Displaying the Contents of the GEM Service Logs

You can check the contents of the GEM Service logs with any of the following methods: Log Viewer GUI displays, Log Viewer file output, and Get SECS Communications Log (GEM\_GetCommLog) instruction execution.

#### Log Viewer GUI Displays

You can view the contents of the GEM Service logs on the Log Viewer GUI. Refer to *6-3-4 Procedure to Display a GEM Service Log* on page 6-8 for a detailed GUI procedure.

#### Log Viewer File Output

You can output the contents of the GEM Service logs to files from the Log Viewer. Refer to *6-3-10 Outputting Logs to Files* on page 6-19 for a detailed file output procedure.

#### Get SECS Communications Log (GEM\_GetCommLog) Instruction Execution

Of the GEM Service logs, you can get the contents of the SECS message log with the Get SECS Communications Log (GEM\_GetCommLog) instruction. You can get up to 100 records with each execution of this instruction. Use the following procedure.

- 1** Execute the GEM\_GetCommLog instruction.

The most recent records from the SECS message log are stored in the `_GEM_CommLog[100]` (SECS Communications Log) system-defined variable. The most recent SECS message log record is stored in `_GEM_CommLog[0]`. Other records are stored in chronological order in `_GEM_CommLog[1]` and on. The number of SECS message log records that were read is stored in `_GEM_CommLogCnt`.

- 2** Display the contents of `_GEM_CommLog`, e.g., on an HMI.





### Additional Information

To display the SECS message log on an NS/NA-series PT, you must assign the `_GEM_CommLog` (SECS Communications Log) system-defined variable to a functional object on the CX-Designer. To do that, you must register `_GEM_CommLog` in the variable table on the CX-Designer.

You can create a variable table for `_GEM_CommLog` with Microsoft Excel and copy it to the CX-Designer.

Use the following format to create the variable table in a Microsoft Excel spreadsheet. You must use the same number and arrangement of columns and the same variable names and types as in the following format. Do not omit any columns even if they are empty, like the *Address type/address* and *I/O comment* columns that are shown below.

Copy the shaded portion shown below and paste it into the variable table on the CX-Designer.

Host	Variable	Type	Address type/address	I/O comment	Tag
HOST3	<code>_GEM_CommLogCnt</code>	UINT			TRUE
HOST3	<code>_GEM_CommLog[0].LogNo</code>	UDINT			TRUE
HOST3	<code>_GEM_CommLog[0].LogDate</code>	DATE_AND_TIME			TRUE
HOST3	<code>_GEM_CommLog[0].SndRcv</code>	USINT			TRUE
HOST3	<code>_GEM_CommLog[0].StreamCode</code>	USINT			TRUE
HOST3	<code>_GEM_CommLog[0].FunctionCode</code>	USINT			TRUE
HOST3	<code>_GEM_CommLog[0].MsgPtn</code>	USINT			TRUE
HOST3	<code>_GEM_CommLog[0].OutType</code>	USINT			TRUE
HOST3	<code>_GEM_CommLog[0].Rslt</code>	USINT			TRUE

Refer to the *NJ/NX-series CPU Unit Software User's Manual* (Cat. No. W501) for information on how to register variables in the variable table on the CX-Designer.

## 6-3 Log Viewer Operations

This section describes the operating methods of the Log Viewer up to displaying the GEM Service logs.

### 6-3-1 Installation of GEM Setting Tools

Install the GEM Setting Tools on the computer on which to use the Log Viewer. After you install the GEM Setting Tools, you can use the following two tools: Log Viewer and SECS/GEM Configurator.

Refer to *8-1 Installing and Uninstalling the GEM Setting Tools* on page 8-3 for details on installing the GEM Setting Tools.

### 6-3-2 Starting and Stopping the Log Viewer

To start the Log Viewer, use the Windows Start Menu or double-click the Log Viewer shortcut icon on your desktop. When the Log Viewer starts, the Main Window is displayed.

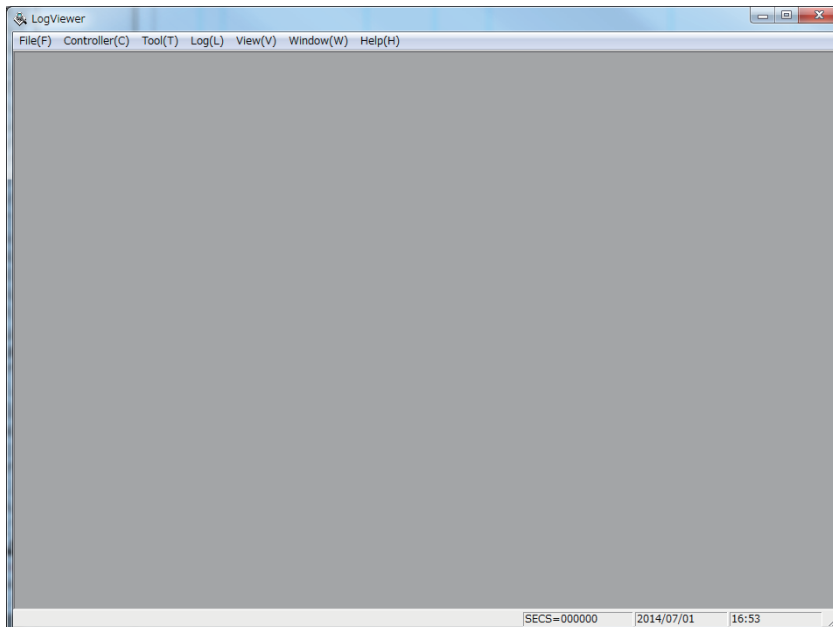

To exit the Log Viewer, select **Exit** from the File Menu. Or, click the **Close** Button in the upper right corner of the Main Window.

### 6-3-3 Configuration of the Main Window

The Main Window consists of the following elements.

- Menus
- Display area
- Status bar

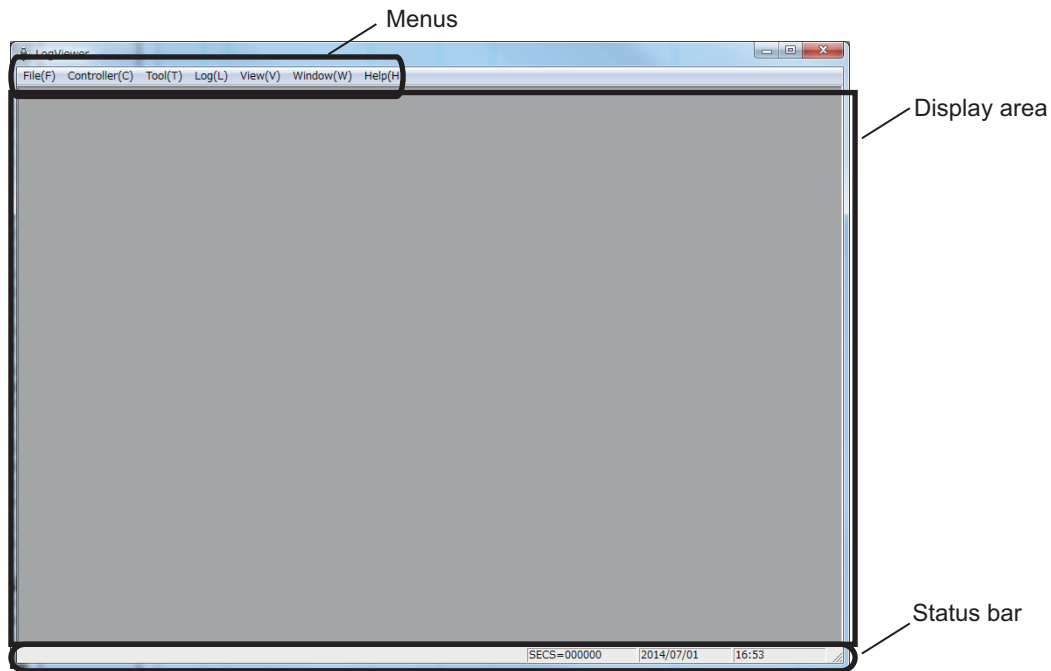

#### ● Menus

The menus are used to operate the Log Viewer. The menu configuration and functions are described in the following table.

Level 1	Level 2	Function
File	Select Log	Selects the GEM Service log file to display.
	Output Log	Outputs the GEM Service logs to files.
	Exit	Exits the Log Viewer.
Controller	Connection Settings	Used to make settings for connection to the Controller.
	Upload	Uploads the GEM Service logs from the Controller.
Tool	Folder Setting	Used to set the folders in which to save the GEM Service logs.
Log	SECS Message log	Displays the SECS message log.
	HSMS communication log	Displays the HSMS communications log.
	Execution log	Displays the execution log.
View	Enable Filter	Enables/disables the filters.
	Filter Settings	Sets the period for displaying log records.
	SECS Log Summary	Displays up to five lines of the contents of each SECS message body.
	Save Current Setting	Saves the current settings of the Log Viewer.
Window	Cascade	Cascades the windows for more than one GEM Service log.
	Tile	Tiles the GEM Service log windows horizontally.
	Arrange Icons	Arranges the minimized windows.
Help	About the Software	Displays version information for the Log Viewer.

- **Display Area**

The GEM Service log is displayed in this area.

- **Status Bar**

The current time and date are displayed.

### 6-3-4 Procedure to Display a GEM Service Log

Use the following procedure to display a GEM Service log.

- 1** Set the saving destination for the GEM Service logs.
- 2** Make the settings for connection to the Controller.
- 3** Upload the GEM Service logs from the Controller.
- 4** Display the GEM Service log.

Operations on the Log Viewer are described according to the above procedure.

## Setting the Saving Destination for GEM Service Logs

Set the folder in which to save the uploaded GEM Service logs. Use the following procedure.

- 1** Select **Folder Setting** from the Tool Menu.  
The Folder Setting Dialog Box is displayed.

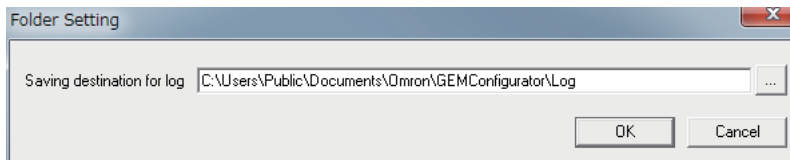

- 2** Select the folder in which to save the files and click the **OK** Button.

The error messages that are sometimes displayed for this menu command are described in the following table.

Error message	Cause	Correction
The folder specified as the saving destination for log does not exist.	The specified log does not exist on the computer that is running the Log Viewer.	Set a folder that exists on the computer or create the specified folder.
The path name includes invalid character(s). The following characters cannot be used: · * ? " < >	As given in the error message.	Set a folder name that does not contain the invalid characters.
A path name cannot exceed 128 characters.	As given in the error message.	Specify a folder name including the path with no more than 128 characters.

## Controller Connection Settings

Make the settings to connect the Log Viewer to the Controller. Use the following procedure.

- 1 Select **Connection Settings** from the Controller Menu.

The Connection Settings Dialog Box is displayed.

- 2 Enter the items and then click the **OK** Button.

Make the same settings here as those made in the connection settings for the SECS/GEM Configurator. The meaning of each item is given in the following table.

Item	Meaning
Connection type	The method used to connect to the Controller.
IP address	The IP address of the Controller.
Configuration port No.	The port number to use to connect to the Controller.
FTP settings	The FTP settings for the Controller.
Port No.	The port number to use for FTP communications with the Controller.
Login name	The login name to use for FTP communications.
Password	The password to use for FTP communications.

## Uploading GEM Service Logs

You must upload the GEM Service logs from the Controller. Use the following procedure.

- 1 Select **Upload** from the Controller Menu.

The Upload Dialog Box is displayed.

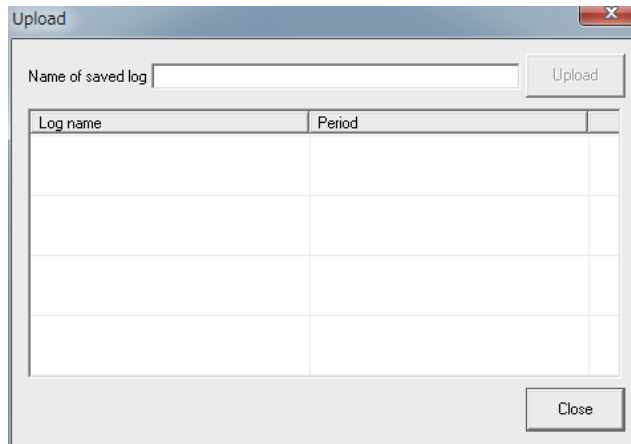

- 2 Enter the save log name and click the **Upload** Button.  
Uploading the GEM Service logs starts.
- 3 When the upload is completed, the save log name is displayed in the Upload Dialog Box.

The error messages that are sometimes displayed for this menu command are described in the following table.

Error message	Cause	Correction
The entered name is already used.	As given in the error message.	Change the save log name.
Cannot connect to the controller.	There is a problem in connecting to the Controller.	Check the following. <ul style="list-style-type: none"> <li>• Are the connection settings correct?</li> <li>• Has an error occurred in the Controller?</li> <li>• Is the Ethernet cable or USB cable disconnected?</li> </ul>
Cannot access the SD Memory Card.	As given in the error message.	Make sure that an SD Memory Card is inserted and that an error has not occurred for it.
Failed to transfer.	The GEM Service logs were not uploaded normally.	Check the following. <ul style="list-style-type: none"> <li>• Are the connection settings correct?</li> <li>• Has an error occurred in the Controller or SD Memory Card?</li> <li>• Is the Ethernet cable or USB cable disconnected?</li> </ul>
Log does not exist.	As given in the error message.	Nothing has happened that resulted in logging a record on the Controller.

## Displaying GEM Service Logs

You can display a GEM Service log in the display area. Use the following procedure.

- 1 Select **Select Log** from the File Menu.  
The Select Log Dialog Box is displayed.

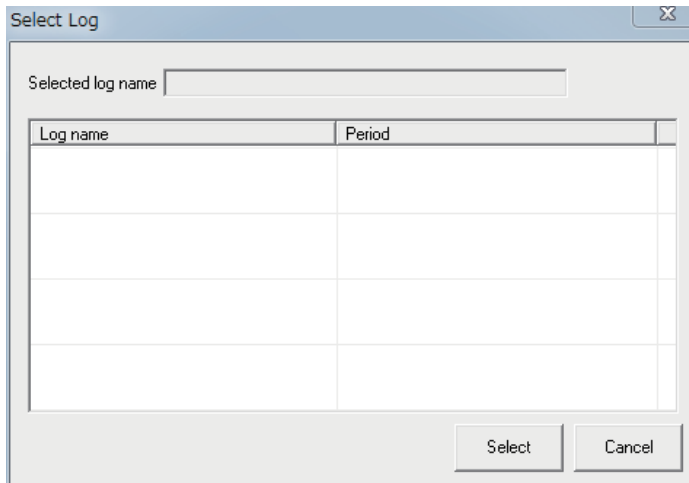

- 2 Select the GEM Service log to display and click the **Select** Button.
- 3 Execute one of the following menu commands depending on the GEM Service log to display.

GEM Service log	Menu command
SECS message log	<b>Log – SECS Message log</b>
HSMS communications log	<b>Log – HSMS Communication log</b>
Execution log	<b>Log – Execution log</b>

### 6-3-5 Displaying the SECS Message Log

There are the following three ways to display the SECS message log.

SECS message log display method	Description
List view	The information from the SECS message log is displayed with each record on a separate line.
Summary view	In addition to the list display of the SECS message log, up to five lines of the contents of each SECS message body are displayed.
Detail view	In addition to the list display of the SECS message log, detailed SECS message information is displayed.

The operating methods for each view and the displayed contents are described next.

#### List View of SECS Message Log

The information from the SECS message log is displayed with each record on a separate line. To display the list view of the SECS message log, select **SECS Message log** from the Log Menu.

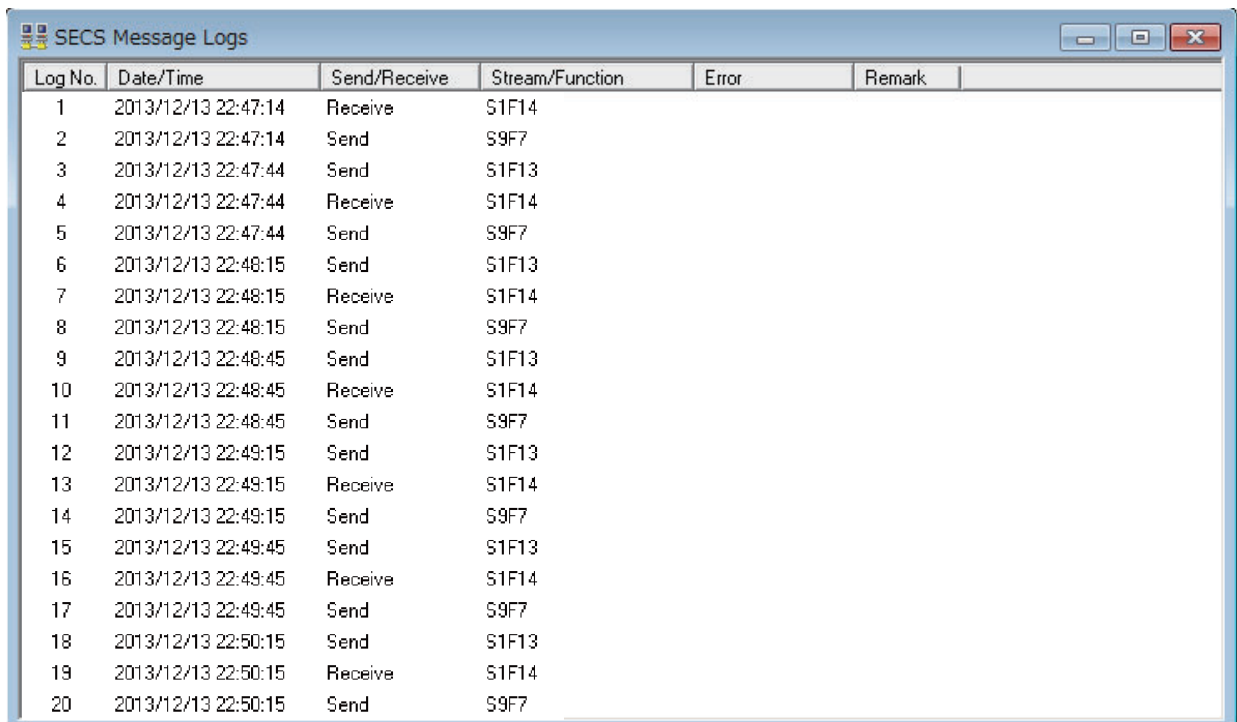

The screenshot shows a window titled "SECS Message Logs" with a table of log entries. The table has columns for Log No., Date/Time, Send/Receive, Stream/Function, Error, and Remark. The entries are as follows:

Log No.	Date/Time	Send/Receive	Stream/Function	Error	Remark
1	2013/12/13 22:47:14	Receive	S1F14		
2	2013/12/13 22:47:14	Send	S9F7		
3	2013/12/13 22:47:44	Send	S1F13		
4	2013/12/13 22:47:44	Receive	S1F14		
5	2013/12/13 22:47:44	Send	S9F7		
6	2013/12/13 22:48:15	Send	S1F13		
7	2013/12/13 22:48:15	Receive	S1F14		
8	2013/12/13 22:48:15	Send	S9F7		
9	2013/12/13 22:48:45	Send	S1F13		
10	2013/12/13 22:48:45	Receive	S1F14		
11	2013/12/13 22:48:45	Send	S9F7		
12	2013/12/13 22:49:15	Send	S1F13		
13	2013/12/13 22:49:15	Receive	S1F14		
14	2013/12/13 22:49:15	Send	S9F7		
15	2013/12/13 22:49:45	Send	S1F13		
16	2013/12/13 22:49:45	Receive	S1F14		
17	2013/12/13 22:49:45	Send	S9F7		
18	2013/12/13 22:50:15	Send	S1F13		
19	2013/12/13 22:50:15	Receive	S1F14		
20	2013/12/13 22:50:15	Send	S9F7		



The following items are displayed.

Item	Meaning
Log No. *1	Number that gives the order of the record in the log. Serial numbers from 1 to the maximum number of records are used. If the maximum number of records is exceeded, the log returns to log number 1.
Date/Time	The date and time when the record was recorded.
Send/Receive	Tells whether the message was sent or received. Send: The SECS message was sent. Receive: The SECS message was received.
Stream/Function	The stream and function of the SECS message that was sent or received.
Error	The error if an error occurred when the SECS message was sent or received. T3: T3 timeout T5: T5 timeout T6: T6 timeout NotConnected: A SECS message for which sending failed because communications were not connected.
Remark	SPOOL is displayed if the SECS message was sent by the spool.

\*1. Even if the records that are displayed are changed by applying a filter, the log numbers are not reassigned so the relationship between the records and log numbers does not change.

## Summary View of SECS Message Log

In addition to the list display of the SECS message log, up to five lines of the contents of each SECS message body are displayed. To display the summary view, select **SECS Log Summary** from the View Menu. A maximum of 10,000 records can be displayed in the summary view. If there are more than 10,000 records in the log, use a filter to reduce the number of displayed records to 10,000 or less.

Log No.	Date/Time	Send/Receive	Stream/Function	Error	Remark
9	2013/12/14 00:03:47	Send	S1F13 <L[2] <A[6]"NJ_GEM" <A[6]"V0.0.1" >		
10	2013/12/14 00:04:49	Send	S1F13 <L[2] <A[6]"NJ_GEM" <A[6]"V0.0.1" >		
11	2013/12/14 00:04:49	Receive	S1F14 <L[2] <B[1]0x00> <L[0]> >		
12	2013/12/14 00:04:52	Send	S1F1		
13	2013/12/14 00:04:52	Receive	S1F2 <L[0]>		
14	2013/12/14 00:04:52	Send	S6F11 <L[3]		

## Detail View of SECS Message Log

In addition to the list display of the SECS message log, detailed SECS message information is displayed. Double-click any line in the list view of the SECS message log. Detailed information on that SECS message will be displayed in a separate window. You can open more than one detail information window at the same time.

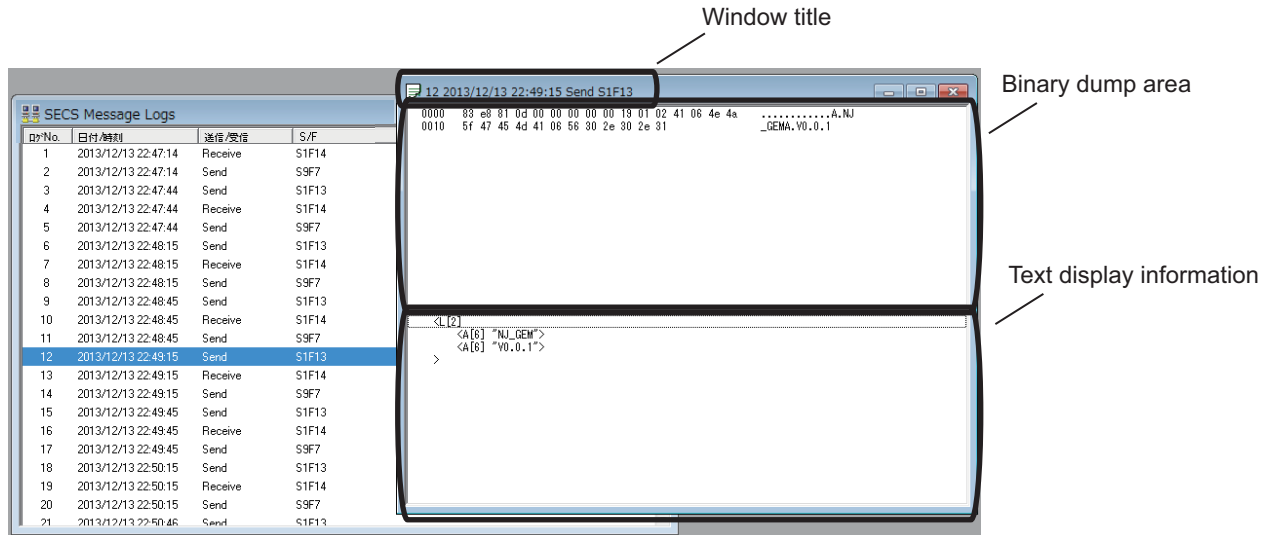

The following items are displayed.

Item	Meaning
Window title	The outline of the SECS message that is displayed in the list view.
Binary dump area	A binary dump of the SECS message.
Byte offsets	The byte position in the SECS message from the first byte in the line is displayed in hexadecimal.
Binary data	The binary data of the SECS message is displayed in 16 bytes per line. Each byte is displayed as two hexadecimal digits.
ASCII display	The binary data for the line is displayed in ASCII characters. Periods are displayed when the actual characters cannot be displayed.
Text display information	The text contents of the SECS message body is displayed with the notation methods for the SECS-II message structure.

## 6-3-6 Displaying the HSMS Communications Log

The information from the HSMS communications log is displayed with each record on a separate line. To display the list view of the HSMS communications log, select **HSMS Communication log** from the Log Menu.

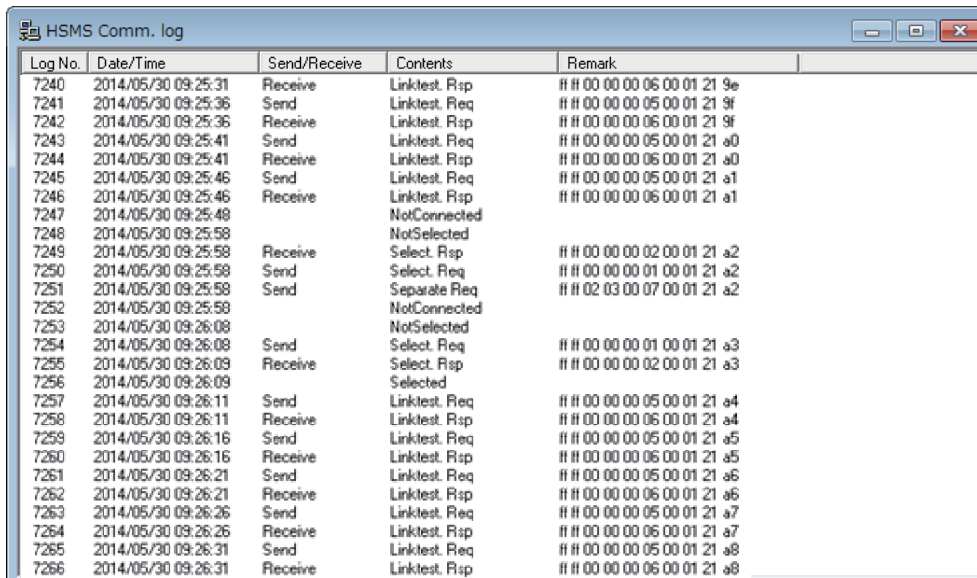

Log No.	Date/Time	Send/Receive	Contents	Remark
7240	2014/05/30 09:25:31	Receive	Linktest. Rsp	## 00 00 00 06 00 01 21 9e
7241	2014/05/30 09:25:36	Send	Linktest. Req	## 00 00 00 05 00 01 21 9f
7242	2014/05/30 09:25:36	Receive	Linktest. Rsp	## 00 00 00 06 00 01 21 9f
7243	2014/05/30 09:25:41	Send	Linktest. Req	## 00 00 00 05 00 01 21 a0
7244	2014/05/30 09:25:41	Receive	Linktest. Rsp	## 00 00 00 06 00 01 21 a0
7245	2014/05/30 09:25:46	Send	Linktest. Req	## 00 00 00 05 00 01 21 a1
7246	2014/05/30 09:25:46	Receive	Linktest. Rsp	## 00 00 00 06 00 01 21 a1
7247	2014/05/30 09:25:48		NotConnected	
7248	2014/05/30 09:25:58		NotSelected	
7249	2014/05/30 09:25:58	Receive	Select. Rsp	## 00 00 00 02 00 01 21 a2
7250	2014/05/30 09:25:58	Send	Select. Req	## 00 00 00 01 00 01 21 a2
7251	2014/05/30 09:25:58	Send	Separate Req	## 02 03 00 07 00 01 21 a2
7252	2014/05/30 09:25:58		NotConnected	
7253	2014/05/30 09:26:08		NotSelected	
7254	2014/05/30 09:26:08	Send	Select. Req	## 00 00 00 01 00 01 21 a3
7255	2014/05/30 09:26:09	Receive	Select. Rsp	## 00 00 00 02 00 01 21 a3
7256	2014/05/30 09:26:09		Selected	
7257	2014/05/30 09:26:11	Send	Linktest. Req	## 00 00 00 05 00 01 21 a4
7258	2014/05/30 09:26:11	Receive	Linktest. Rsp	## 00 00 00 06 00 01 21 a4
7259	2014/05/30 09:26:16	Send	Linktest. Req	## 00 00 00 05 00 01 21 a5
7260	2014/05/30 09:26:16	Receive	Linktest. Rsp	## 00 00 00 06 00 01 21 a5
7261	2014/05/30 09:26:21	Send	Linktest. Req	## 00 00 00 05 00 01 21 a6
7262	2014/05/30 09:26:21	Receive	Linktest. Rsp	## 00 00 00 06 00 01 21 a6
7263	2014/05/30 09:26:26	Send	Linktest. Req	## 00 00 00 05 00 01 21 a7
7264	2014/05/30 09:26:26	Receive	Linktest. Rsp	## 00 00 00 06 00 01 21 a7
7265	2014/05/30 09:26:31	Send	Linktest. Req	## 00 00 00 05 00 01 21 a8
7266	2014/05/30 09:26:31	Receive	Linktest. Rsp	## 00 00 00 06 00 01 21 a8

The following items are displayed.

Item	Meaning
Log No. *1	Number that gives the order of the record in the log. Serial numbers from 1 to the maximum number of records are used. If the maximum number of records is exceeded, the log returns to log number 1.
Date/Time	The date and time when the record was recorded.
Send/Receive	Gives the send/receive classification of the HSMS procedural message and the connection status. Blank: HSMS status Send: The message was sent. Receive: The message was received.
Contents	The HSMS status or the procedural message type. See below for details.
Remark	Displays a binary dump of the HSMS message.

\*1. Even if the records that are displayed are changed by applying a filter, the log numbers are not reassigned so the relationship between the records and log numbers does not change.

The meanings of the connection status given in the *Contents* column and the meanings of the procedural messages are given in the following tables.

HSMS status	Meaning
NOT CONNECTED	Preparations for TCP/IP connections have been completed, but no connections have been established. Or, all previously established TCP/IP connections have been ended.
NOT SELECTED	No HSMS sessions have been established. Or, all previously established HSMS sessions have been ended.
SELECTED	At least one HSMS session has been established. This is the normal operating status for HSMS. Data messages can be exchanged.

Procedural message	Meaning
Select.req	The request message for a selection procedure.
Select.rsp	The response message for a selection procedure. The connection status changes to SELECTED.
Linktest.req	The request message for a link test procedure.
Linktest.rsp	The response message for a link test procedure.
Separate.req	The request message for a separation procedure. There is no response to a separation procedure request. The connection status changes to NOT SELECTED.
Reject.req	The request message for a reject procedure. There is no response to a reject procedure request.

## 6-3-7 Displaying the Execution Log

The information from the execution log is displayed with each record on a separate line. To display the list view of the execution log, select **Execution log** from the Log Menu.

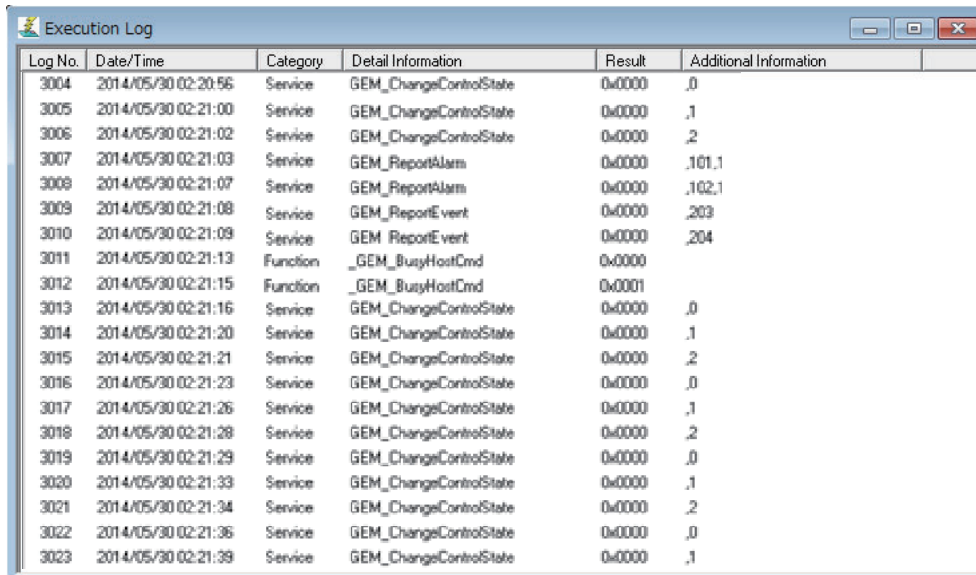

Log No.	Date/Time	Category	Detail Information	Result	Additional Information
3004	2014/05/30 02:20:56	Service	GEM_ChangeControlState	0x0000	.0
3005	2014/05/30 02:21:00	Service	GEM_ChangeControlState	0x0000	.1
3006	2014/05/30 02:21:02	Service	GEM_ChangeControlState	0x0000	.2
3007	2014/05/30 02:21:03	Service	GEM_ReportAlarm	0x0000	.101.1
3008	2014/05/30 02:21:07	Service	GEM_ReportAlarm	0x0000	.102.1
3009	2014/05/30 02:21:08	Service	GEM_ReportEvent	0x0000	.203
3010	2014/05/30 02:21:09	Service	GEM_ReportEvent	0x0000	.204
3011	2014/05/30 02:21:13	Function	_GEM_BusyHostCmd	0x0000	
3012	2014/05/30 02:21:15	Function	_GEM_BusyHostCmd	0x0001	
3013	2014/05/30 02:21:16	Service	GEM_ChangeControlState	0x0000	.0
3014	2014/05/30 02:21:20	Service	GEM_ChangeControlState	0x0000	.1
3015	2014/05/30 02:21:21	Service	GEM_ChangeControlState	0x0000	.2
3016	2014/05/30 02:21:23	Service	GEM_ChangeControlState	0x0000	.0
3017	2014/05/30 02:21:26	Service	GEM_ChangeControlState	0x0000	.1
3018	2014/05/30 02:21:28	Service	GEM_ChangeControlState	0x0000	.2
3019	2014/05/30 02:21:29	Service	GEM_ChangeControlState	0x0000	.0
3020	2014/05/30 02:21:33	Service	GEM_ChangeControlState	0x0000	.1
3021	2014/05/30 02:21:34	Service	GEM_ChangeControlState	0x0000	.2
3022	2014/05/30 02:21:36	Service	GEM_ChangeControlState	0x0000	.0
3023	2014/05/30 02:21:39	Service	GEM_ChangeControlState	0x0000	.1

The following items are displayed.

Item		Meaning
Log No. *1		Number that gives the order of the record in the log. Serial numbers from 1 to the maximum number of records are used. If the maximum number of records is exceeded, the log returns to log number 1.
Date/Time		The date and time when the record was recorded.
Category		The execution log category. Function: Instruction execution Variable: Transaction processing flag or interlock variable
Detail Information	When category is <i>Function</i>	Executed instruction
	When category is <i>Variable</i>	The transaction processing flag or interlock variable for the SECS message that was received.
Result	When category is <i>Function</i>	Result of instruction execution 0x0000: Successful Not 0x0000: Failed (The values are the same as the error IDs of the executed instruction.)
	When category is <i>Variable</i>	0x0000: Transaction processing flag written successfully. 0x0001: Interlock
Additional Information	When category is <i>Function</i>	The values of the input variables to the instruction.
	When category is <i>Variable</i>	When <i>Variable</i> is a transaction processing flag, the value of the transaction processing flag. When <i>Variable</i> is an interlock variable, nothing is recorded.

\*1. Even if the records that are displayed are changed by applying a filter, the log numbers are not reassigned so the relationship between the records and log numbers does not change.

## 6-3-8 Filters

Filters are used when you display the GEM Service logs to prevent unnecessary information from being displayed by restricting the period for which to display records. There are two menu commands related to the filters: **Filter Settings** and **Enable Filter**.

### Filter Settings

You use the filter settings to set the period for displaying log records. You can set different display periods for the SECS message log, HSMS communications log, and execution log. Use the following procedure.

- 1 Select **Filter Settings** from the View Menu.

The Filter Setting Dialog Box is displayed.

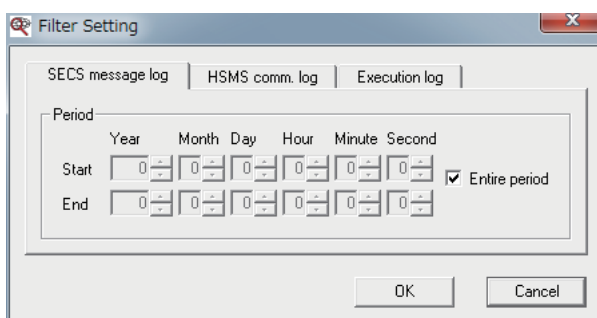

- 2 Click the tab for the SECS message log, HSMS communications log, or execution log.
- 3 Set the start date and time and the end date and time of the display period. You can select the *Entire period* Check Box to specify displaying records for the entire period.
- 4 Click the **OK** Button.

### Enabling the Filters

To enable the filters, select **Enable Filter** from the View Menu.

## 6-3-9 Saving the Current Settings

You can select **Save Current Setting** from the View Menu to save the current values for the following Log Viewer settings. If you save the current settings, they will be used the next time you start the Log Viewer.

- The column that was used to sort the lines when each log was displayed
- The column widths when each of the logs was displayed
- The filter settings
- The summary view settings for the SECS message log

## 6-3-10 Outputting Logs to Files

You can output the contents of the GEM Service logs to files. You can output the following four files.

- SECS message log (list)
- SECS message log (detail)
- HSMS communications log
- Execution log

Use the following procedure.

- 1 Select **Output Log** from the File Menu.  
The Output Log Dialog Box is displayed.

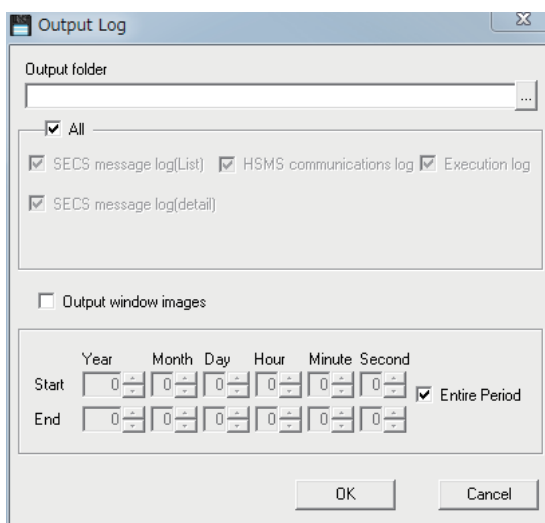

- 2 Enter the items and then click the **OK** Button.  
The meaning of each item is given in the following table.

Item	Meaning
Output folder	Specify the full path of the folder in which to save the output files.
Logs	Select the logs to output to files. You can select any of the following: SECS message log (list), SECS message log (detail), HSMS communications log, and execution log. If you select the <i>All</i> Check Box, all four of the above logs are output.
Period to output	Specify the period of the log records to output to the files. If you select the <i>Output window images</i> Check Box, the information that is displayed in the windows will be output. *1 If you select the <i>Entire period</i> Check Box, all of the records for the entire period are output.

\*1. If the filters are enabled, the records for the periods set for the filters are output. The log line sort conditions in the output files are the same as the line sort conditions for the logs displayed in the windows. Even if a log is displayed, it will not be output unless you select it in the file output settings. The filter conditions and line sort conditions for the SECS message log (detail) are the same as those for the SECS message log (list).

## Output File for SECS Message Log (List)

The SECS message log (list) is output to a CSV file called CommLog.csv.

The format of the output file for the SECS message log (list) depends on whether the list view is displayed or the summary is displayed.

### ● Format of Output File for SECS Message Log (List)

The format of the output file for the SECS message log (list) is shown below. The output contents are the same as the contents that are displayed in the window.

1,	2014/05/22 12:57:42,	Send,S1F13,,,			
2,	2014/05/22 12:57:42,	Receive,S1F14,,,			
3,	2014/05/22 12:59:15,	Send,S1F13,NotConnected,,			
4,	2014/05/22 13:00:15,	Send,S1F13,,,			
5,	2014/05/22 13:00:15,	Receive,S1F14,,,			

Log No. Date/Time Send/ Stream/ Error Remark  
Receive Function

### ● Format of Output File for Summary of SECS Message Log (List)

The format of the output file for the summary of the SECS message log (list) is shown below. The output contents are the same as the contents that are displayed in the window.

1,	2014/05/22 12:57:42,	Send,S1F13,,,			
		<L[2],,,			
		<A[4] "MDLN">,,,			
		<A[3] "REV">,,,			
		>,,,			
2,	2014/05/22 12:57:42,	Receive,S1F14,,,			
		<L[2],,,			
		<B[1] 0x00>,,,			
		<L[0]>,,,			
		>,,,			

Log No. Date/Time Send/ Stream/ Error Remark  
Receive Function

Message body



## Output File for SECS Message Log (Detail)

The SECS message log (detail) is output to a text file called CommLogDetail.txt.

The format of the output file for the SECS message log (detail) is shown below. The output contents are the same as the contents that are displayed in the window.

The screenshot shows a window titled "1 2014/05/22 12:57:42 Send S1F13". It contains two message entries. The first entry shows a binary dump: "0000 80 00 81 0d 00 00 00 00 01 01 02 41 04 4d 44 ..... A . MD" and "0010 4c 4e 41 03 52 45 56 LNA.REV". Below the dump is a text representation: "<L[2]<br><A[4] 'MDLN'><br><A[3] 'REV'><br>>". The second entry is titled "2 2014/05/22 12:57:42 Receive S1F14" and shows a binary dump: "0000 00 00 01 0e 00 00 00 00 01 01 02 21 01 00 01 ....." and "0010 00". Its text representation is: "<L[2]<br><B[1] 0x00><br><L[0]><br>>".

## Output File for HSMS Communications Log

The HSMS communications log is output to a CSV file called HsmsLog.csv. The format of the output file for the HSMS communications log is shown below. The output contents are the same as the contents that are displayed in the window.

10256,2014/05/30 09:26:09,,DeSelect. Req,
10257,2014/05/30 09:26:11,Send,,ff ff 00 00 00 05 00 01 21 a4
10258,2014/05/30 09:26:11,Receive,,ff ff 00 00 00 06 00 01 21 a4
10259,2014/05/30 09:26:16,Send,,ff ff 00 00 00 05 00 01 21 a5

Log No.	Date/Time	Send/Receive	Contents	Remark
---------	-----------	--------------	----------	--------

## Output File for Execution Log

The execution log is output to a CSV file called ExeLog.csv. The format of the execution log output file is shown below. The output contents are the same as the contents that are displayed in the window.

9,2014/05/30 02:21:15,2,_GEM_BusyHostCmd,0x0001,,
10,2014/05/30 02:21:16,1,GEM_ChangeControlState,0x0000,"0",
11,2014/05/30 02:21:20,1,GEM_ChangeControlState,0x0000,"1",

Log No.	Date/Time	Category	Detail Information	Result	Additional Information
---------	-----------	----------	--------------------	--------	------------------------

### 6-3-11 Windows

You can rearrange the windows that display the logs to make them easier to see. You can rearrange the windows in the following three ways.

- Cascade  
You can cascade the windows. Select **Cascade** from the Windows Menu.
- Tile  
You can tile the windows. Select **Tile** from the Windows Menu.
- Arrange Icons  
You can arrange the minimized windows. Select **Arrange Icons** from the Windows Menu.

### 6-3-12 Help

Select **About the Software** from the Help Menu to display version information on the Log Viewer as shown below.

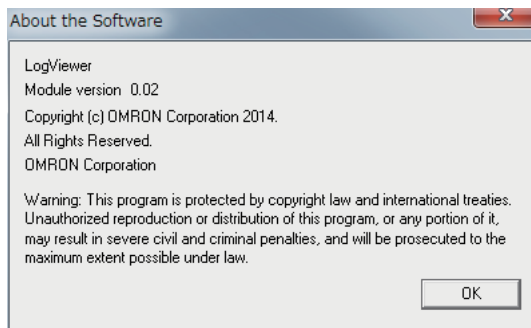



# Functionality Other Than the GEM Services

The SECS/GEM CPU Unit provides functionality that is not directly related to the SECS/GEM standards. This section describes that functionality.

---

<b>7-1 SD Memory Cards</b>	<b>7-2</b>
7-1-1 Directory Structure of the SD Memory Card	7-2
7-1-2 Restrictions When No SD Memory Card Is Inserted	7-2
7-1-3 Operation When Data Cannot Be Saved in the SD Memory Card	7-2
7-1-4 Operation When the SD Memory Card Is Replaced	7-3
<b>7-2 Backup Functions</b>	<b>7-5</b>
7-2-1 Data That Is Backed Up	7-5
7-2-2 Data That Is Not Backed Up	7-5
7-2-3 Backup Functions for GEM Setting Data	7-5
7-2-4 Compatibility between CPU Unit Models	7-6
7-2-5 Compatibility between Versions of CPU Units	7-6
7-2-6 Restrictions for Backup Function Execution	7-7

## 7-1 SD Memory Cards

When you use the GEM Services, insert an SD Memory Card into the CPU Unit. The SD Memory Card is used to store the GEM Service logs and spooled data. Also, the SD Memory Card is temporarily used for data storage during processing when GEM setting data or the project is uploaded or downloaded.

The SECS/GEM CPU Unit supports the same SD Memory Cards as the NJ-series Standard CPU Units.

### 7-1-1 Directory Structure of the SD Memory Card

The directory structure of the SD Memory Card and the usage of each directory are described in the following table.

Directory	Usage
/packages/GEM/log	Stores the GEM Service logs.
/packages/GEM/spool	Stores the spool data.

### 7-1-2 Restrictions When No SD Memory Card Is Inserted

Restrictions When No SD Memory Card Is Inserted

- The GEM Service logs are not recorded.
- The spooled data is not saved.
- You cannot transfer the GEM setting data from or to the SECS/GEM Configurator.

Communications with the host are possible even if an SD Memory Card is not inserted into the CPU Unit.

### 7-1-3 Operation When Data Cannot Be Saved in the SD Memory Card

Data cannot be saved in the SD Memory Card in the following cases.

- There is no SD Memory Card inserted in the CPU Unit.
- The SD Memory Card does not have enough available space.
- The SD Memory Card is write protected.
- The SD Memory Card is faulty.

The following events are registered depending on the data that cannot be saved in the SD Memory Card.

Data	Event code	Event name	Level
GEM Service log	14E100000 hex	GEM Service Log Save Failed	Observation
Spooled data	14E300000 hex	Spool Save Failed	Minor fault

## 7-1-4 Operation When the SD Memory Card Is Replaced

The operation when the SD Memory Card is replaced depends on whether it is replaced after the power supply to the Controller is turned OFF or it is replaced while the equipment is operating.

### Replacement After Turning OFF the Power Supply to the Controller

The operation of the GEM Service logs and spooling and the events that are created when the SD Memory Card is replaced after the power supply to the Controller is turned OFF are described in the following table. These depend on the operation that is performed by the user.

User operation	Operation of GEM Service logs	Operation of spooling	Event
The user turns ON the power supply without inserting an SD Memory Card.	Records are not saved.	Spool data is not saved.	Invalid SD Memory Card (14E40000 hex)
The user inserts an SD Memory Card that cannot be written to and then turns ON the power supply. *1			
The user inserts an SD Memory Card on which no GEM Service logs or spooled data is saved and turns ON the power supply.	Records are saved.	Spool data is saved.	Valid SD Memory Card (95450000 hex)
The user inserts an SD Memory Card that contains GEM Service logs or spooled data and turns ON the power supply.	<ul style="list-style-type: none"> <li>If the GEM Service logs that are saved are normal, records are saved at the ends of the existing files.</li> <li>If the GEM Service logs that are saved are not correct, those files are deleted and the records are saved to new files.</li> </ul>	<ul style="list-style-type: none"> <li>If the spool data that is saved is normal, spooled data continues to be saved to the same file.</li> <li>If the spool data that is saved is not correct, that file is deleted and the spooled data is saved to a new file.</li> </ul>	

\*1. This is an SD Memory Card that is write protected or faulty.

## Replacement during Equipment Operation

The operation of the GEM Service logs and spooling and the events that are created when the SD Memory Card is replaced during equipment operation are described in the following table. These depend on the operation that is performed by the user.

User operation	Operation of GEM Service logs	Operation of spooling	Event
The user removes the SD Memory Card.	Records are not saved.	Spooled data is not saved.	Invalid SD Memory Card (14E40000 hex)
The user inserts an SD Memory Card that cannot be written to.*1			
The user inserts an SD Memory Card on which no GEM Service logs or spooled data is saved.	Records are saved.	Spooled data is saved.	Valid SD Memory Card (95450000 hex)
The user inserts an SD Memory Card that contains GEM Service logs or spooled data.	<ul style="list-style-type: none"> <li>If the GEM Service logs that are saved are normal, records are saved at the ends of the existing files.</li> <li>If the GEM Service logs that are saved are not correct, those files are deleted and the records are saved to new files.</li> </ul>	<ul style="list-style-type: none"> <li>The saved spool data is deleted and the spooled data is saved to a new file.</li> </ul>	

\*1. This is an SD Memory Card that is write protected or faulty.



### Precautions for Correct Use

Perform one of the following operations to prevent errors and data corruption when you remove the SD Memory Card.

- Execute a shutdown and then turn OFF the power supply to the Controller.
- Change the operating mode of the CPU Unit to PROGRAM mode and press the SD Memory Card power supply switch.

## 7-2 Backup Functions

You can back up, restore, and compare the data in the CPU Unit. This functionality is useful in the event that the CPU Unit fails. The functions used to back up, restore, and compare data are collectively called the backup functions.

### 7-2-1 Data That Is Backed Up

The backup functions of the SECS/GEM CPU Unit apply to the following data.

Data	Description
Standard backup data	This backup data is the same as the backup data for an NJ-series Standard CPU Unit.*1
GEM setting data	This setting data is specific to the GEM Services.
Event logs*2	These event logs are the same as the event logs for an NJ-series Standard CPU Unit.*3

\*1. Refer to the *NJ/NX-series CPU Unit Software User's Manual* (Cat. No. W501) for information on the backup data of an NJ-series Standard CPU Unit.

\*2. The event logs are only backed up. You cannot restore or compare them.

\*3. Refer to the *NJ/NX-series CPU Unit Software User's Manual* (Cat. No. W501) for information on the event logs of an NJ-series Standard CPU Unit.

System-defined variables that are specific to the SECS/GEM CPU Unit are backed up only if they have a Retain attribute. They are not backed up if they do not have a Retain attribute. Refer to *A-2 System-defined Variables* on page A-211 for the system-defined variables that are specific to the SECS/GEM CPU Unit and for the attributes of those variables.

### 7-2-2 Data That Is Not Backed Up

The following data is not backed up. This data is saved in the SD Memory Card, so you can save it on your computer or other device.

- GEM Service logs
- Spooled data



#### Precautions for Correct Use

If you replace the CPU Unit and insert the SD Memory Card that was used in the old CPU Unit into the new CPU Unit, the GEM Service log and spool data files are deleted. Save the data in advance on your computer or other device.

### 7-2-3 Backup Functions for GEM Setting Data

Of the backup functions that you can use on the SECS/GEM CPU Unit, the following backup functions apply to the GEM setting data.

- SD Memory Card backups
- Automatic transfers from SD Memory Cards
- Sysmac Studio Controller backups

**Precautions for Correct Use**

The Sysmac Studio backup file import/export functions and the Sysmac Studio variable/memory backup functions do not apply to the GEM setting data. If you use these functions to back up and restore data, the GEM setting data from before data restoration will remain.

**7-2-4 Compatibility between CPU Unit Models**

The following table shows the compatibility of the backup functions when the CPU Unit model where the data was backed up from is different from the CPU Unit model where the data is being restored.

CPU Unit model where data was backed up	CPU Unit model to restore to	
	NJ501-1340	NJ-series CPU Unit other than NJ501-1340
NJ501-1340	Compatible	Not compatible
NJ-series CPU Unit other than NJ501-1340	Not compatible	*1

\*1. Refer to the *NJ/NX-series CPU Unit Software User's Manual* (Cat. No. W501) for information on the compatibility of two NJ-series CPU Units that are not NJ501-1340 CPU Units.

**7-2-5 Compatibility between Versions of CPU Units**

There are two types of versions for the CPU Unit: the unit version and the GEM Service version.

The following table shows the compatibility of the backup functions when the combination of CPU Unit versions where the data was backed up from are different from the combination of CPU Unit versions where the data is being restored.

Refer to *Versions* on page 21 for the methods to check the CPU Unit version and the GEM Service version.

Unit version	GEM Service version	
	Backup source $\leq$ Restore destination	Backup source $>$ Restore destination
Backup source $\leq$ Restore destination	Compatible*1	Not compatible
Backup source $>$ Restore destination	Not compatible	Not compatible

\*1. If the GEM Service version of the backup source is lower than the version of the restore destination, you must convert the GEM setting data. Use the following procedure to convert the data.

- (1) Restore the data.
- (2) Upload the GEM setting data to the SECS/GEM Configurator.
- (3) Convert the GEM setting data so that it agrees with the version of the GEM Services.
- (4) Download the GEM setting data to the Controller.



## 7-2-6 Restrictions for Backup Function Execution

The following restrictions apply when you execute backup functions during operation of the GEM Services.

Backup function	CPU Unit operating mode	Restriction
Backup	PROGRAM mode	If you download the GEM setting data during a backup, the expected operation may not be performed.
	RUN mode	If the GEM Service status is Run, the GEM setting data that was changed from the host may not be backed up correctly. Back up the data after changing the GEM Service status to Idle.
Restoring	PROGRAM mode	If you restore data, the spool data file is deleted.
	RUN mode	You cannot restore data in RUN mode.
Comparison	PROGRAM mode	The GEM setting data that was dynamically changed by the host after the data was backed up may be detected as unmatched data.
	RUN mode	



# 8

## SECS/GEM Configurator

The SECS/GEM Configurator is a different software application from the Sysmac Studio or Log Viewer. You use it to create, edit, and save the GEM setting data. This section describes the functions and operating procedures of the SECS/GEM Configurator.

<b>8-1</b>	<b>Installing and Uninstalling the GEM Setting Tools</b>	<b>8-3</b>
8-1-1	Installation Precautions	8-3
8-1-2	Applicable Operating Systems for the GEM Setting Tools	8-3
8-1-3	Installed Application Software	8-3
8-1-4	Installation Procedure for the GEM Setting Tools	8-4
8-1-5	Uninstallation Procedure for the GEM Setting Tools	8-7
<b>8-2</b>	<b>Starting and Exiting the SECS/GEM Configurator</b>	<b>8-8</b>
8-2-1	Starting the SECS/GEM Configurator	8-8
8-2-2	Exiting the SECS/GEM Configurator	8-9
<b>8-3</b>	<b>Configuration of the SECS/GEM Configurator</b>	<b>8-10</b>
8-3-1	Window Configuration	8-10
8-3-2	Menu Structure	8-11
8-3-3	Operating Buttons	8-14
<b>8-4</b>	<b>Menu Bar Functions</b>	<b>8-15</b>
8-4-1	File	8-15
8-4-2	Build	8-19
8-4-3	Controller	8-21
8-4-4	Tool	8-26
8-4-5	Documentation	8-30
8-4-6	Window	8-34
8-4-7	Help	8-35
<b>8-5</b>	<b>Toolbar Configuration</b>	<b>8-36</b>
<b>8-6</b>	<b>Basic Operations on the List Menus</b>	<b>8-37</b>
8-6-1	List Menu Dialog Boxes	8-37
8-6-2	Setting Dialog Boxes	8-38
8-6-3	Variable Dialog Boxes	8-40
<b>8-7</b>	<b>Configuration</b>	<b>8-42</b>
8-7-1	GEM Service Log	8-42

<b>8-8 HSMS Settings</b> .....	<b>8-43</b>
8-8-1 HSMS Condition .....	8-43
<b>8-9 Data Definition</b> .....	<b>8-45</b>
8-9-1 Item .....	8-45
8-9-2 Equipment Constant (EC) .....	8-47
8-9-3 Status Variable (SV) .....	8-50
8-9-4 Discrete Variable (DV) .....	8-53
8-9-5 List Structure Definitions .....	8-56
<b>8-10 Model Settings</b> .....	<b>8-58</b>
8-10-1 Communications State Model .....	8-58
8-10-2 Control State Model .....	8-59
<b>8-11 GEM Capability Settings</b> .....	<b>8-60</b>
8-11-1 Event Notification .....	8-61
8-11-2 Alarm Management .....	8-69
8-11-3 Host Command .....	8-72
8-11-4 Enhanced Remote Command .....	8-76
8-11-5 Equipment Constants .....	8-80
8-11-6 Process Program Management .....	8-81
8-11-7 Equipment Terminal Service .....	8-90
8-11-8 Limit Monitoring .....	8-92
8-11-9 Spooling .....	8-93
<b>8-12 Message Settings</b> .....	<b>8-95</b>
8-12-1 GEM Standard Messages .....	8-95
8-12-2 User-defined Messages .....	8-96
<b>8-13 Confirm Settings</b> .....	<b>8-101</b>
8-13-1 Item List .....	8-101
8-13-2 Message List .....	8-102
8-13-3 Event List .....	8-102
8-13-4 Report List .....	8-103
8-13-5 Alarm List .....	8-103

# 8-1 Installing and Uninstalling the GEM Setting Tools

Install the GEM Setting Tools on the computer on which to use the SECS/GEM Configurator. After you install the GEM Setting Tools, you can use the following two tools: Log Viewer and SECS/GEM Configurator.

## 8-1-1 Installation Precautions

Observe the following precautions when you install the GEM Setting Tools.

- You must log onto Windows as the administrator or as a user with administrator rights.
- You must exit all applications that are running on Windows.
- Do not turn OFF the power to the computer or reset the computer while the installation is in progress.

## 8-1-2 Applicable Operating Systems for the GEM Setting Tools

The GEM Setting Tools will run on the following operating systems.

- Windows XP with SP3 (excluding 64-bit edition)
- Windows Vista (excluding 64-bit edition)
- Windows 7 (32-bit or 64-bit edition)

## 8-1-3 Installed Application Software

After you install the GEM Setting Tools, you can use the following applications.

- SECS/GEM Configurator
- Log Viewer
- Communications Middleware

## 8-1-4 Installation Procedure for the GEM Setting Tools

Use the following procedure to install the GEM Setting Tools.

- 1 Set the GEM Setting Tools installation disk into the DVD-ROM drive in the computer. The Select Language Dialog Box is displayed.

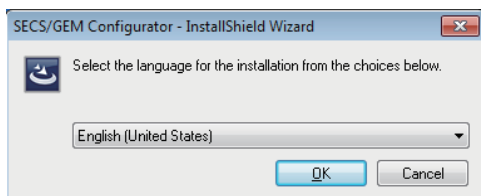

- 2 Select the language to use, and then click the **OK** Button. The following dialog box is displayed.

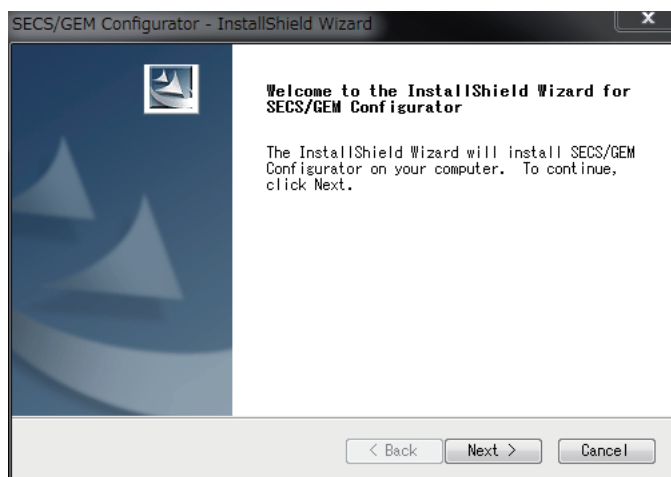

If the GEM Setting Tools were previously installed, the above dialog box is not displayed. A warning message is displayed, and the installation is canceled.

- 3 Click the **Next** Button. The License Agreement Dialog Box is displayed.

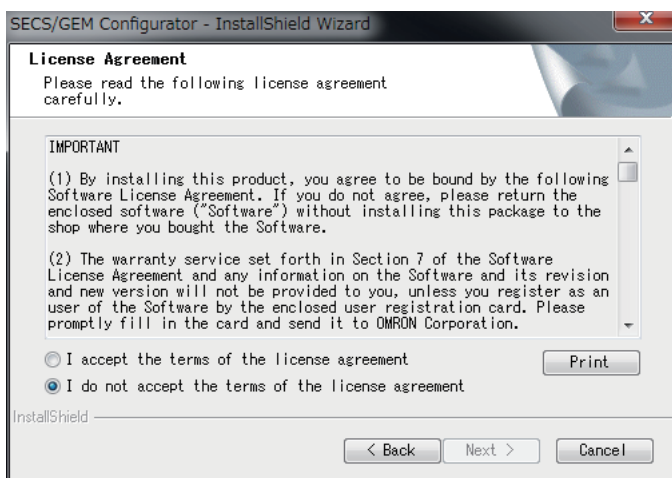

- 4 If you agree to all of the conditions in the License Agreement, select the *I accept the terms of the license agreement* Option, and then click the **Next** Button.

The User Information Dialog Box is displayed.

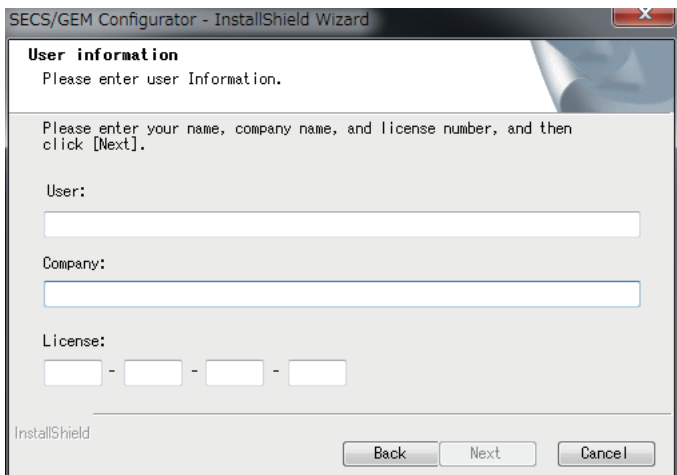

- 5 Enter the user name, company name, and license number, and then click the **Next** Button.

The Choose Destination Location Dialog Box is displayed.

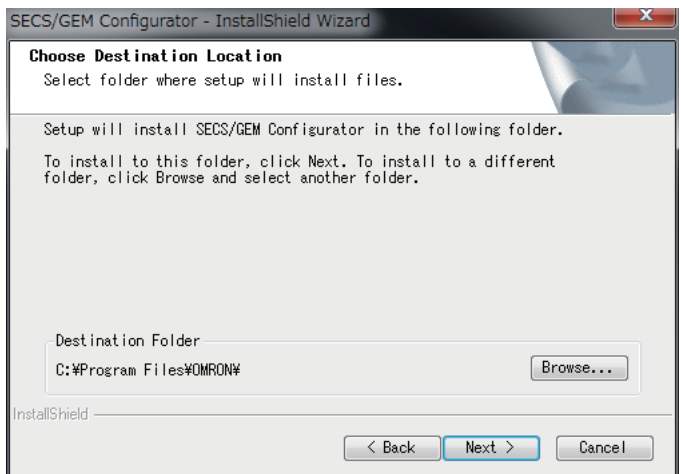

- 6** Specify the installation destination folder, and then click the **Next** Button.  
The Ready to Install the Program Dialog Box is displayed.

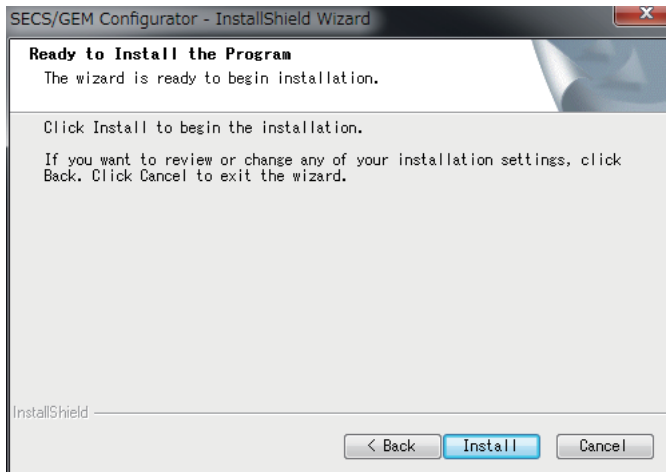

The default installation folder is C:\Program Files\OMRON\.

- 7** Click the **Install** Button.

The software is installed.

When the installation is completed, an Installation Completed Dialog Box is displayed.

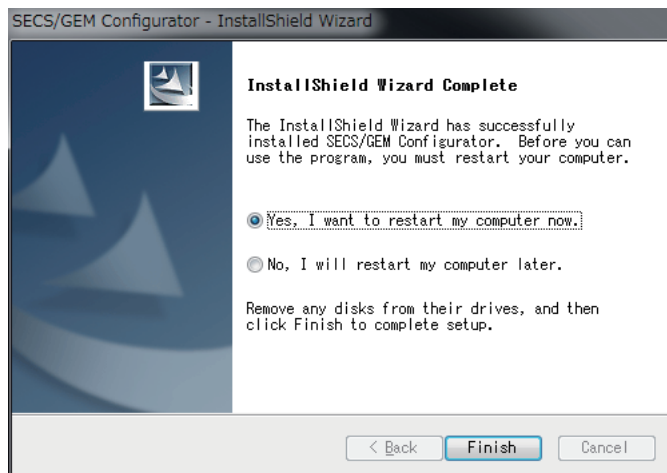

- 8** Select the *Yes, I want to restart my computer now* Option, and then click the **Finish** Button.  
The computer is restarted.



## 8-1-5 Uninstallation Procedure for the GEM Setting Tools

Use the following procedure to uninstall the GEM Setting Tools.

- 1 Open the Control Panel from the Windows Start Menu and then select **Programs and Features**.

The Uninstall or Change a Program Dialog Box is displayed.

- 2 Select the SECS/GEM Configurator and click the **Uninstall** Button.  
A Delete File Confirmation Dialog Box is displayed.

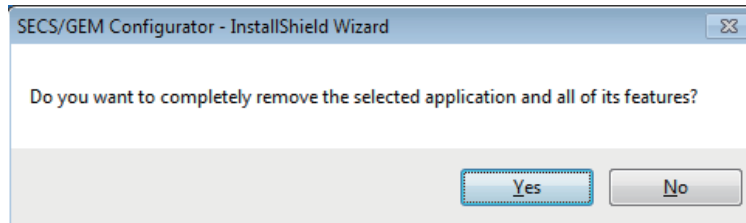

- 3 Click the **Yes** Button.

The software is uninstalled.

When the software has been uninstalled, an Uninstallation Completed Dialog Box is displayed.

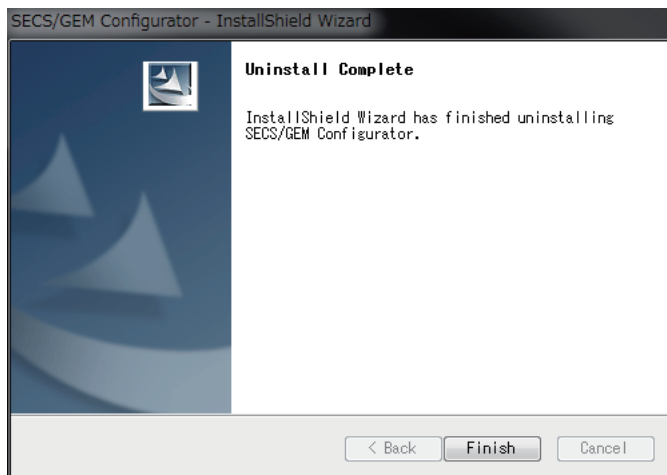

- 4 Click the **Finish** Button.

## 8-2 Starting and Exiting the SECS/GEM Configurator

This section describes how to start and exit the SECS/GEM Configurator.

### 8-2-1 Starting the SECS/GEM Configurator

To start the SECS/GEM Configurator, use the Windows Start Menu or double-click the shortcut icon on your desktop.

When the SECS/GEM Configurator starts, the Project Window is displayed.

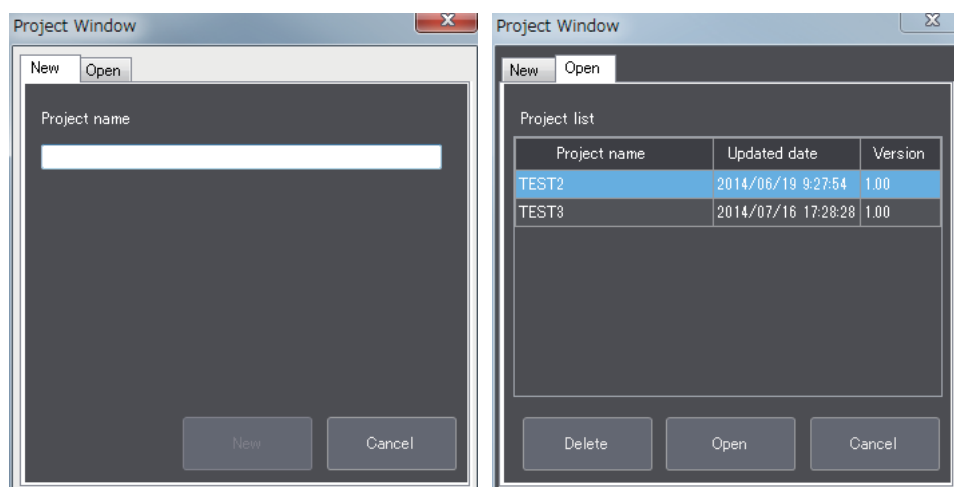

### Project Creation

Use the following procedure to create a project.

- 1** Click the **New** Tab in the Project Window.
- 2** Enter the project name.
- 3** Click the **New** Button.

The Main Window is displayed and the project name that you entered is displayed as the project name.

The project name must not be more than 160 characters long, including the file path that is specified with **Folder Settings** under the Tool Menu.

The project file is created in the folder that is specified with **Folder Settings** under the Tool Menu.

The error messages that may be displayed for this menu command are described in the following table.

Error message	Cause	Correction
The entered name is already used.	As given in the error message.	Change the project name.
You cannot use following characters for a project name: \\ / * ? " < >	As given in the error message.	Set a project name that does not contain invalid characters.

## Opening an Existing Project

---

Use the following procedure to open an exiting project.

- 1** Click the **Open** Tab in the Project Window.  
A list of the existing project names is displayed.  
You can sort the list in ascending or descending order by clicking the *Project name* or *Updated date* column title.
- 2** Select the name of the project to open.
- 3** Click the **Open** Button.  
The Main Window is displayed and the specified project is opened.



### Additional Information

---

There is no command available to change the project name. To change a project name, save the project under a different name and then delete the original project.

---

## 8-2-2 Exiting the SECS/GEM Configurator

To exit the SECS/GEM Configurator, select **Exit** from the File Menu. Or, click the **Close** Button in the upper right corner of the Main Window.

## 8-3 Configuration of the SECS/GEM Configurator

This section describes the window configuration, the menu structure, and the meanings of the operating buttons of the SECS/GEM Configurator.

### 8-3-1 Window Configuration

The SECS/GEM Configurator window consists of the following elements.

- Title bar  
The project name and version of the SECS/GEM Configurator are displayed.
- Menu bar  
The menu bar provides the menu commands that you use to connect to the Controller, make file settings, make operation environment settings, and perform other operations.
- Toolbar  
The toolbar provides icons to create projects, open projects, and save projects. You can access commands on the File Menu to achieve the same things.
- Project name display area  
This area displays the name of the project that you are currently editing.
- List menus  
These menus are used to access settings for the GEM Services.
- Editing area  
You use this area to edit the settings for the GEM Services. When you select an item on a list menu, a setting pane for the relevant data is displayed in the editing area.

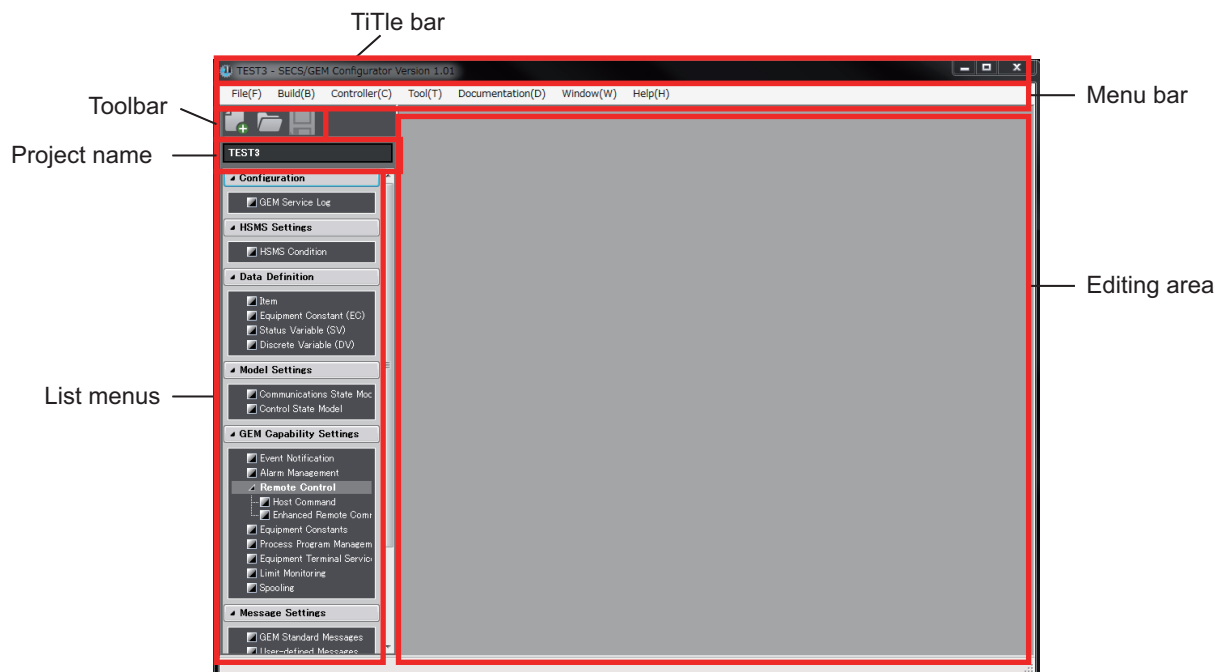

## 8-3-2 Menu Structure

This section describes the menu structure. There are three ways to access commands for the SECS/GEM Configurator: the menu bar, the toolbar, and the list menus.

### Menu Bar Configuration

The following table shows the configuration of the menus on the menu bar, describes the functions of the commands, and provides reference pages.

Menu	Command	Function	Reference
File	New	Creates a project.	<i>New</i> on page 8-16
	Open	Opens an existing project.	<i>Open</i> on page 8-17
	Close	Closes the project that you are editing.	<i>Close</i> on page 8-17
	Save	Overwrites the project that you are editing with the current file name.	<i>Save</i> on page 8-17
	Save As	Saves the project that you are editing under a new file name.	<i>Save As</i> on page 8-18
	Create SML File	Creates an SML file for use with the Host Simulator.	<i>Create SML File</i> on page 8-18
	Exit	Exits the SECS/GEM Configurator.	<i>Exit</i> on page 8-19
Build	Build	Checks the settings. This command also creates the GEM setting data to transfer to the Controller.	<i>Build</i> on page 8-19
Controller	Connection Settings	Sets the conditions for connecting the SECS/GEM Configurator to the Controller.	<i>Connection Settings</i> on page 8-21
	Transfer to Controller	Transfers the GEM setting data from the computer to the Controller.	<i>Transfer to Controller</i> on page 8-22
	Transfer from Controller	Transfers the GEM setting data from the Controller to the computer.	<i>Transfer from Controller</i> on page 8-23
	GEM Service Operation	Changes the GEM Service status in the SECS/GEM CPU Unit.	<i>GEM Service Operation</i> on page 8-25
Tool	Folder Settings	Sets the folder in which to save projects.	<i>Folder Settings</i> on page 8-26
	Controller Variable	Used to display Controller variable lists, edit Controller variables, and import/export Controller variables.	<i>Controller Variable</i> on page 8-27
Documentation	Documentation	Outputs CSV files of information that is required for equipment documentation.	<i>8-4-5 Documentation</i> on page 8-30
Window	Cascade	Cascades the dialog boxes that are displayed in the editing area.	<i>Cascade</i> on page 8-34
	Close All	Closes all of the dialog boxes that are displayed in the editing area.	<i>Close All</i> on page 8-34
Help	About Software	Displays version information on the SECS/GEM Configurator.	<i>About Software</i> on page 8-35

## Toolbar Configuration

The following three icons are displayed in the toolbar.

- **New** Icon
- **Open** Icon
- **Save** Icon

Refer to *8-5 Toolbar Configuration* on page 8-36 for more information on the toolbar.

## List Menu Structure

The following table shows the configuration of the list menus, describes the functions of the commands, and provides reference pages.

Menu	Command	Function	Reference
Configuration	GEM Service Log	Makes settings for saving the GEM Service logs.	<i>8-7-1 GEM Service Log</i> on page 8-42
HSMS Settings	HSMS Condition	Makes settings for HSMS communications, such as the host IP address and timeout values.	<i>8-8-1 HSMS Condition</i> on page 8-43
Data Definition	Item	Used to define items.	<i>8-9-1 Item</i> on page 8-45
	Equipment Constant (EC)	Used to define equipment constants and set link variables.	<i>8-9-2 Equipment Constant (EC)</i> on page 8-47
	Status Variable (SV)	Used to define status variables and set link variables.	<i>8-9-3 Status Variable (SV)</i> on page 8-50
	Discrete Variable (DV)	Used to define discrete variables and set link variables.	<i>8-9-4 Discrete Variable (DV)</i> on page 8-53
Model Settings	Communications State Model	Sets the default communications state, the equipment model type, and the software revision.	<i>8-10-1 Communications State Model</i> on page 8-58
	Control State Model	Sets the default control state and other settings.	<i>8-10-2 Control State Model</i> on page 8-59

Menu	Command	Function	Reference
GEM Capability Settings	Event Notification	Makes settings related to event definitions and report definitions.	<i>8-11-1 Event Notification</i> on page 8-61
	Alarm Management	Makes settings related to alarm definitions.	<i>8-11-2 Alarm Management</i> on page 8-69
	Remote Control – Host Command	Makes settings for remote control host commands.	<i>8-11-3 Host Command</i> on page 8-72
	Remote Control – Enhanced Remote Command	Makes settings for enhanced remote commands for remote control.	<i>8-11-4 Enhanced Remote Command</i> on page 8-76
	Equipment Constants	Makes settings related to equipment constants.	<i>8-11-5 Equipment Constants</i> on page 8-80
	Process Program Management	Makes settings related to process programs.	<i>8-11-6 Process Program Management</i> on page 8-81
	Equipment Terminal Service	Makes settings related to the equipment terminal service.	<i>8-11-7 Equipment Terminal Service</i> on page 8-90
	Limit Monitoring	Makes settings related to limit monitoring.	<i>8-11-8 Limit Monitoring</i> on page 8-92
	Spooling	Makes settings related to spooling.	<i>8-11-9 Spooling</i> on page 8-93
Message Settings	GEM Standard Messages	Makes settings to enable or disable GEM standard messages and settings for W bits.	<i>8-12-1 GEM Standard Messages</i> on page 8-95
	User-defined Messages	Makes settings related to user-defined messages.	<i>8-12-2 User-defined Messages</i> on page 8-96
Confirm Settings	Item List	Displays an item list.	<i>8-13-1 Item List</i> on page 8-101
	Message List	Displays a message list.	<i>8-13-2 Message List</i> on page 8-102
	Event List	Displays an event list.	<i>8-13-3 Event List</i> on page 8-102
	Report List	Displays a report list.	<i>8-13-4 Report List</i> on page 8-103
	Alarm List	Displays an alarm list.	<i>8-13-5 Alarm List</i> on page 8-103

### 8-3-3 Operating Buttons

The following tables list the operating buttons that are the same in the dialog boxes for different menu commands and describes their functions.

Button	Function
Apply	Enables the settings in the currently displayed dialog box. If you close a dialog box or change the tab page without clicking the <b>Apply</b> Button, the settings that were made on the relevant dialog box are discarded.
Edit	Enables editing the selected item.
Add	Adds a new row to an item list.
Delete	Deletes the selected row from an item list.
Copy	Adds a row with the same contents as the selected row to an item list. Use this button to create a new item by changing only some of the settings of an existing item.
Cancel	Discards the settings.
Close	Closes the currently displayed dialog box.



## 8-4 Menu Bar Functions

The menu bar provides the menu commands that you use to connect to the Controller, make file settings, make operation environment settings, and perform other operations. The following seven menus are provided at the top level of the menu structure.

- File
- Build
- Controller
- Tool
- Documentation
- Window
- Help

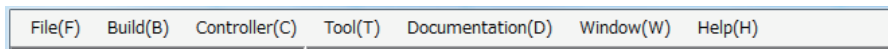

### 8-4-1 File

The File Menu is mainly used to make settings related to project files. This menu provides the following seven commands/menus.

- New
- Open
- Close
- Save
- Save As
- Create SML File
- Exit

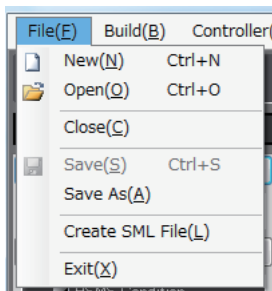

## New

The **New** command creates a project.

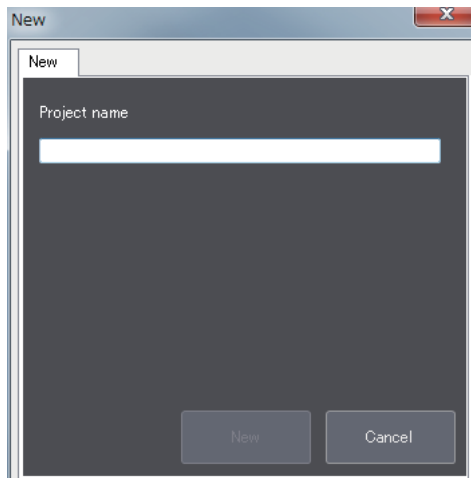

If you enter the project name and click the **New** Button, a project with the entered project name is created.

The error messages that may be displayed for this menu command are described in the following table.

Error message	Cause	Correction
The entered name is already used.	As given in the error message.	Change the project name.
You cannot use following characters for a project name: \\ / * ? " < >	As given in the error message.	Set a project name that does not contain invalid characters.

You can also create a project with the  icon in the toolbar.

## Open

The **Open** command opens an existing project. You can also delete an existing project file by clicking the **Delete** Button.

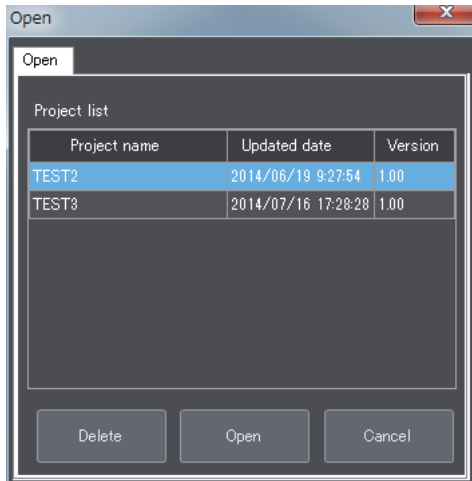

Double-click the project to open in the list of existing project names. Or, you can select the name of the project to open and click the **Open** Button to open the selected project.

The error messages that may be displayed for this menu command are described in the following table.

Error message	Cause	Correction
The project was created with a newer version of the SECS/GEM Configurator. It cannot be opened.	As given in the error message.	Check the project versions that are supported by your SECS/GEM Configurator.

You can also open an existing project by clicking the  icon in the toolbar.

## Close

The **Close** command closes the project that you are currently editing.

## Save

The **Save** command overwrites the existing project file with the edited project.

You can also save the file by clicking the  icon in the toolbar.

## Save As

The **Save As** command saves the edited project under a new file name. The file is saved in the folder that is specified with **Folder Settings** under the Tool Menu.

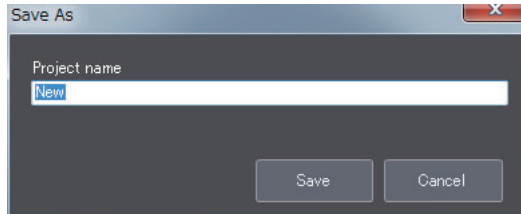

If you enter the project name and click the **Save** Button, the edited project is saved under the project name that you entered.

The error messages that may be displayed for this menu command are described in the following table.

Error message	Cause	Correction
The entered name is already used.	As given in the error message.	Change the project name.
You cannot use following characters for a project name: \\ / * ? " < >	As given in the error message.	Set a project name that does not contain invalid characters.

## Create SML File

The **Create SML File** command outputs an SML file that you can import to the Host Simulator to simulate standard GEM scenarios.

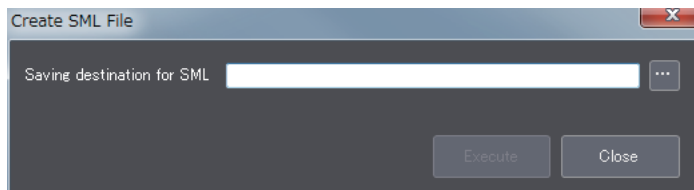

If you enter the name of the folder in which to save the SML file and click the **Execute** Button, the SML file is saved in the specified folder. The file name is *project\_name.sml*.

The error messages that may be displayed for this menu command are described in the following table.

Error message	Cause	Correction
The folder specified as the saving destination for SML file does not exist.	As given in the error message.	Set a folder that exists on the computer or create the specified folder.
The path name includes invalid character(s). The following characters cannot be used: \\ / * ? " < >	As given in the error message.	Set a folder name that does not contain invalid characters.
The path name for saving SML files cannot exceed 128 characters.	As given in the error message.	Specify the path name for saving SML files with 128 characters or less.
The Project has not been built.	As given in the error message.	Build the project first and then create the SML file.



**Precautions for Correct Use**

- The **Create SML File** command cannot be used unless a project is open. Open the project file first and then create the SML file.
- SML files cannot be used with some Host Simulators. Ask where you purchased the Host Simulator for details on the Host Simulator.

**Exit**

The **Exit** command closes the SECS/GEM Configurator.

**8-4-2 Build**

The Build Menu is used to check the settings made on the SECS/GEM Configurator and create the GEM setting data to transfer to the Controller. This menu provides the following command.

- Build

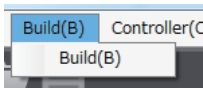

**Build**

Use the following procedure for the **Build** command.

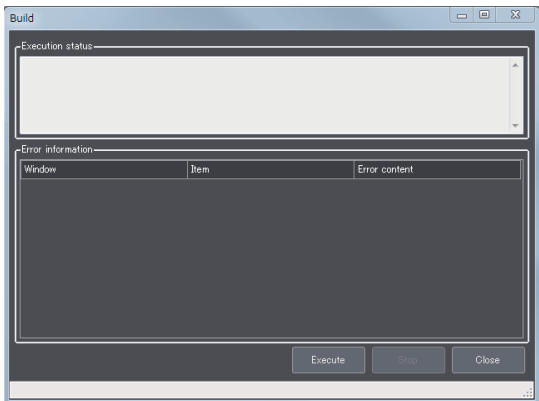

The meanings of the items that are displayed in the Build Dialog Box are described in the following table.

Item	Meaning
Execution status	Displays step numbers to show the progress of the building operation.
Error information	Any errors that are detected up to a maximum of 120 errors are displayed.
Total number of errors	The total number of errors that were detected is displayed in the status bar.

The error messages that are displayed in the Build Dialog Box when the GEM setting data is not created normally are listed in the following table.

Error message	Cause	Correction <sup>*1</sup>
No link variable is assigned.	<ul style="list-style-type: none"> <li>• A link variable is not registered.</li> <li>• Variable that was registered as the link variable was deleted or changed.</li> </ul>	Set a link variable.
The value set for the item (zzzz) is out of the setting range.	<ul style="list-style-type: none"> <li>• The setting of the zzzz item is outside of the range of values that can be specified for the numeric format that was set in the item definition.</li> <li>• The item definition was changed after the item setting was registered.</li> </ul>	Change the item definition or item setting.
The value set for the item (zzzz) is over the valid input range.	<ul style="list-style-type: none"> <li>• The setting of the zzzz item exceeds the data size of the ASCII format that was set in the item definition.</li> <li>• The item definition was changed after the item setting was registered.</li> </ul>	Change the item definition or item setting.
The primary message (Sxx,Fyy) that corresponds to a secondary message is not defined.	As given in the error message.	Define a primary message.
The second message (Sxx,Fyy) that corresponds to a primary message is not defined.	As given in the error message.	Define a secondary message.
Different W-bit settings exist for an identical primary message (Sxx,Fyy).	As given in the error message.	Change the W-bit setting.

\*1. You can identify the setting in which the error was detected from the information displayed in the Window and Items columns of the Build Dialog Box.

### 8-4-3 Controller

The Controller Menu is used to make settings related to the Controller. This menu provides the following four commands.

- Connection Settings
- Transfer to Controller
- Transfer from Controller
- GEM Service Operation

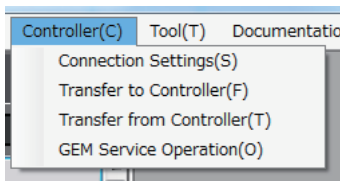

#### Connection Settings

The **Connection Settings** command is used to make settings to connect the SECS/GEM Configurator to the Controller.

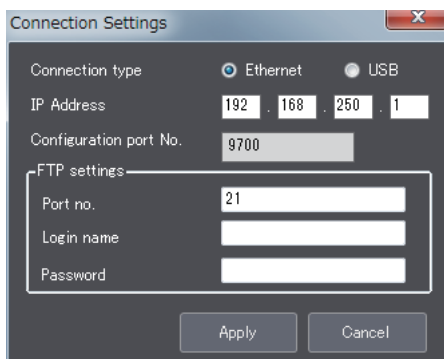

The meanings of the items that are displayed in the Connection Settings Dialog Box are described in the following table.

Item	Meaning
Connection type	The connection method between the SECS/GEM Configurator and Controller.
IP address	The IP address of the Controller.*1
Configuration port No.	The port number to use to connect to the Controller.
FTP settings	The FTP settings for the Controller.
Port No.	The port number to use for FTP communications with the Controller.*2
Login name	The login name to use for FTP communications.
Password	The password to use for FTP communications.

\*1. This setting is not required if the connection type is set to USB.

\*2. Use the same port number as the FTP port number of the Controller.



#### Precautions for Correct Use

Use the same FTP settings as on the Controller. If any of the settings are different, normal communications are not possible.

The error messages that may be displayed for this menu command are described in the following table.

Error message	Cause	Correction
The set IP address is invalid.	As given in the error message.	Check the IP address.
The entered value is out of the specified range. [Range: xxxxx to xxxxx]	As given in the error message.	Change the value of the FTP port number.

## Transfer to Controller

The **Transfer to Controller** command is used to transfer the GEM setting data from the SECS/GEM Configurator to the Controller.

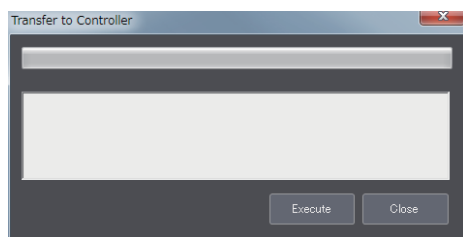

When you click the **Execute** Button, the GEM Service status of the SECS/GEM CPU Unit changes to Stop and the GEM setting data is transferred from the SECS/GEM Configurator to the Controller.

The error messages that may be displayed for this menu command are described in the following table.

Error message	Cause	Correction
The Project has not been built.	As given in the error message.	Build the project first and then transfer the GEM setting data.
There are some changes that were not saved yet.	As given in the error message.	Save the project settings before you transfer the GEM setting data.
Cannot connect to the controller.	An error occurred in the connection with the Controller.	Check the following. <ul style="list-style-type: none"> <li>• Are the settings made with <b>Connection Settings</b> under the Controller Menu correct?</li> <li>• Has an error occurred in the Controller?</li> <li>• Is the Ethernet cable or USB cable connected correctly?</li> <li>• Is the SECS/GEM CPU Unit GEM Service status ShuttingDown or Shutdown?</li> <li>• When the Packet Filter function is used in the SECS/GEM CPU Unit, are the packets used by the SECS/GEM Configurator allowed? Refer to <i>Packet Filter</i> in the <i>NJ/NX-series CPU Unit Built-in EtherNet/IP User's Manual</i> (Cat. No. W506) for details.</li> </ul>
Cannot access the SD Memory Card.	As given in the error message.	Check the following. <ul style="list-style-type: none"> <li>• Is there a SD Memory Card inserted in the CPU Unit?</li> <li>• Is the SD Memory Card write protected?</li> <li>• Is there an error in the SD Memory Card?</li> </ul>
Cannot transfer in the current GEM Service status.	The GEM Service status of the SECS/GEM CPU Unit is EQStarting. Therefore, moving to Stop status is not possible.	Transfer the GEM setting data when the GEM Service status of the SECS/GEM CPU Unit is any status other than EQStarting. Or, change the GEM Service status to Stop before transferring the data.



Error message	Cause	Correction
Failed to change to STOP.	As given in the error message.	Check the following. <ul style="list-style-type: none"> <li>• Has an error occurred in the Controller?</li> <li>• Is the Ethernet cable or USB cable connected correctly?</li> </ul>
Failed to transfer.	It was not possible to transfer the GEM setting data correctly.	Check the following. <ul style="list-style-type: none"> <li>• Are the settings made with <b>Connection Settings</b> under the Controller Menu correct?</li> <li>• Has an error occurred in the Controller?</li> <li>• Is there an error in the SD Memory Card?</li> <li>• Is the Ethernet cable or USB cable connected correctly?</li> </ul>
Failed to change to Release from stop.	As given in the error message.	Check the following. <ul style="list-style-type: none"> <li>• Has an error occurred in the Controller?</li> <li>• Is the Ethernet cable or USB cable connected correctly?</li> </ul>
The version of the connected Controller is not supported.	As given in the error message.	Check the SECS/GEM Configurator project versions that are supported by your Controller.

## Transfer from Controller

The **Transfer from Controller** command is used to transfer the GEM setting data from the Controller to the SECS/GEM Configurator.

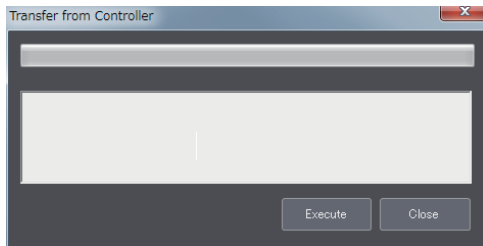

If this command is executed when a project is already open, the project settings are overwritten with the GEM setting data transferred from the Controller.

If a project is not open and this command is executed, the GEM setting data is transferred after you enter a new project name.



### Precautions for Correct Use

The contents of the GEM setting data that was transferred with **Transfer from Controller** is the same as the contents of the GEM setting data that was previously transferred with **Transfer to Controller**. Even if the settings in the GEM setting data were changed by the user program or host after the GEM setting data was transferred to the computer, the changes will not be reflected in the GEM setting data transferred to the Controller.

The error messages that may be displayed for this menu command are described in the following table.

Error message	Cause	Correction
Cannot connect to the controller.	An error occurred in the connection with the Controller.	Check the following. <ul style="list-style-type: none"> <li>• Are the settings made with <b>Connection Settings</b> under the Controller Menu correct?</li> <li>• Has an error occurred in the Controller?</li> <li>• Is the Ethernet cable or USB cable connected correctly?</li> <li>• Is the SECS/GEM Configurator GEM Service status ShuttingDown or Shutdown?</li> <li>• When the Packet Filter function is used in the SECS/GEM CPU Unit, are the packets used by the SECS/GEM Configurator allowed? Refer to <i>Packet Filter</i> in the <i>NJ/NX-series CPU Unit Built-in EtherNet/IP User's Manual</i> (Cat. No. W506) for details.</li> </ul>
Cannot access the SD Memory Card.	As given in the error message.	Check the following. <ul style="list-style-type: none"> <li>• Is there a SD Memory Card inserted in the CPU Unit?</li> <li>• Is the SD Memory Card write protected?</li> <li>• Is there an error in the SD Memory Card?</li> </ul>
Failed to transfer.	As given in the error message.	Check the following. <ul style="list-style-type: none"> <li>• Are the settings made with <b>Connection Settings</b> under the Controller Menu correct?</li> <li>• Has an error occurred in the Controller?</li> <li>• Is there an error in the SD Memory Card?</li> <li>• Is the Ethernet cable or USB cable connected correctly?</li> </ul>
The version of the connected Controller is not supported.	As given in the error message.	Check the project versions that are supported by your SECS/GEM Configurator.

## GEM Service Operation

The **GEM Service Operation** command is used to check or change the GEM Service status of the SECS/GEM CPU Unit.

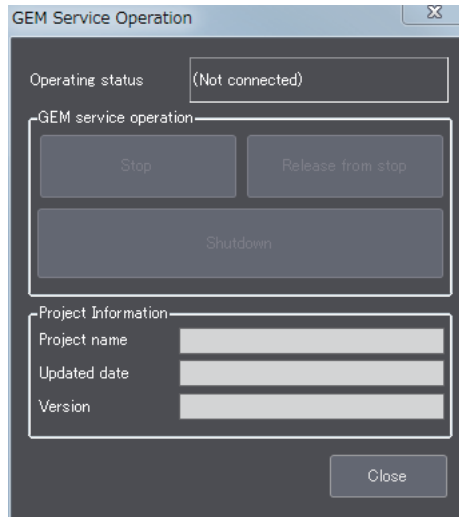

The meanings of the items that are displayed in the GEM Service Operation Dialog Box are described in the following table.

Item	Meaning
Operating status	The GEM Service status of the connected SECS/GEM CPU Unit. If a SECS/GEM CPU Unit is not connected, <i>Not connected</i> is displayed.
GEM Service operation	The buttons that you can use for the GEM Service status of the connected SECS/GEM CPU Unit are enabled. There are three buttons: <b>Stop</b> , <b>Release from stop</b> , and <b>Shutdown</b> .
Project Information	
Project name	The name of the project transferred to the Controller.
Updated date	The most recent date when the project was transferred to the Controller.
Version	The version of the project that was transferred to the Controller.

When you click any of the GEM Service status buttons, the GEM Service status changes as given in the following table.

Button	New GEM Service status
Stop	Stop
Release from stop	Idle
Shutdown	Shutdown

The error messages that may be displayed for this menu command are described in the following table.

Error message	Cause	Correction
Failed to change to STOP.	As given in the error message.	Check the following. <ul style="list-style-type: none"> <li>• Are the settings made with <b>Connection Settings</b> under the Controller Menu correct?</li> <li>• Has an error occurred in the Controller?</li> <li>• Is there an error in the SD Memory Card?</li> <li>• Is the Ethernet cable or USB cable connected correctly?</li> </ul>
Failed to change to Release from stop.	As given in the error message.	
Failed to shutdown.	As given in the error message.	

## 8-4-4 Tool

The Tool Menu is used to set the folder in which to save projects and to import/export Controller variables. This menu provides the following two commands.

- Folder Settings
- Controller Variable

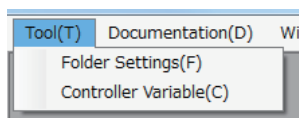

### Folder Settings

The **Folder Settings** command is used to set the folder in which to save projects.

The default folder in which to save the data depends on the operating system of the computer, as shown in the following table.

OS	Default folder
Windows 7 or Windows Vista	C:\Users\Public\Documents\Omron\GEMConfigurator\Project
WindowsXP	C:\Documents and Settings\All Users\Documents\Omron\GEMConfigurator\Project

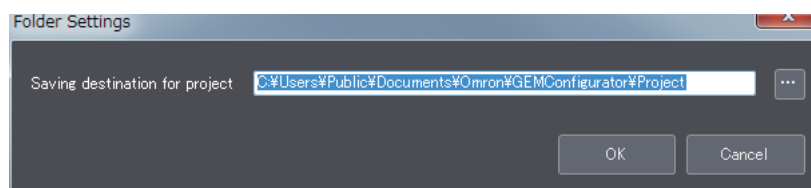

If you enter the saving destination for projects and then click the **OK** Button, the specified folder is set as the saving destination for projects.

The error messages that may be displayed for this menu command are described in the following table.

Error message	Cause	Correction
The folder specified as the saving destination for projects does not exist.	As given in the error message.	Set a folder that exists on the computer or create the specified folder.
The path name includes invalid character(s). The following characters cannot be used: \\ / * ? " < >	As given in the error message.	Set a folder name that does not contain invalid characters.
The path name for saving projects cannot exceed 128 characters.	As given in the error message.	Specify the folder name with 128 characters or less.

## Controller Variable

The **Controller Variable** command is used to import and export Controller variables.

Controller variables are registered on the SECS/GEM Configurator and can be imported and exported between the SECS/GEM Configurator and the Sysmac Studio. You select from the Controller variables to set link variables.

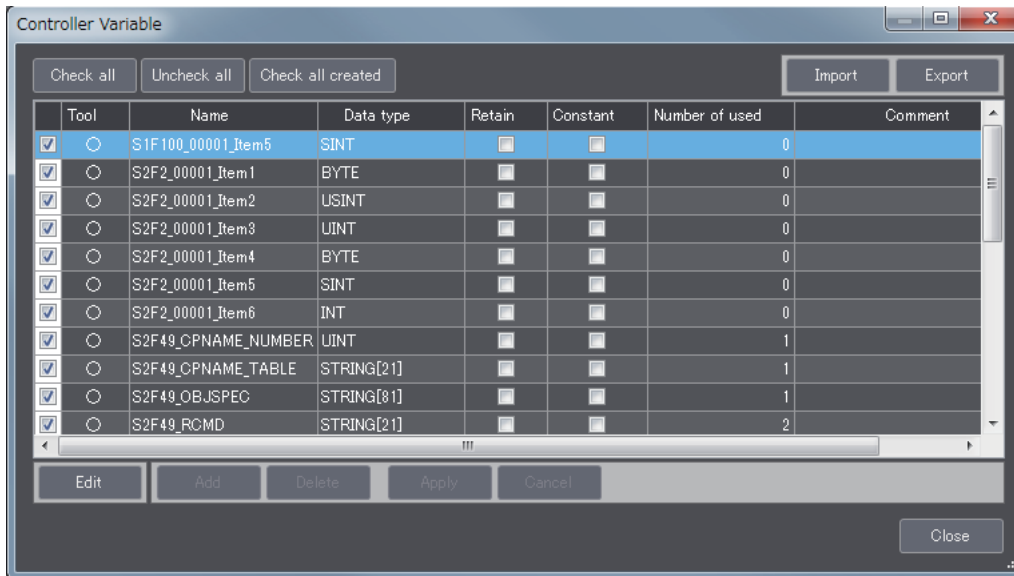

The following table gives the meanings of the attributes of the Controller variables.

Attribute	Meaning
Tool	Displays O for Controller variables that were created on the SECS/GEM Configurator.
Name	The name of the Controller variable.
Data Type	The data type of the Controller variable.
Retain	The Retain attribute of the Controller variable.*1
Constant	The Constant attribute of the Controller variable.*1
Number of used	The number of settings as a link variable.
Comment	The user can enter a description of the Controller variable.

\*1. You can edit this attribute if the number of used attribute is 0.

The meanings of the buttons are described in the following table.

Button	Meaning
Check all	Selects the check boxes for all of the Controller variables.
Uncheck all	Clears the check boxes for all of the Controller variables.
Check all created	Selects the check boxes for all of the Controller variables that were created on the SECS/GEM Configurator.
Edit	Enables editing the attributes of the selected Controller variable. The <b>Add</b> , <b>Delete</b> , <b>Apply</b> , and <b>Cancel</b> Buttons are enabled.
Add	Adds a row to the Controller variable list.
Delete	Deletes the selected Controller variable.
Apply	Applies the changes made in editing.
Cancel	Discards the changes made in editing.
Close	Closes the Controller variable dialog box.

## ● Exporting Controller Variables

Use the following procedure to export the Controller variables.

- 1** If you click the **Export** Button, the Controller variables are saved to the clipboard.
- 2** Import the Controller variables on the clipboard to the global variable table on the Sysmac Studio.

## ● Importing Controller Variables

If you click the **Import** Button, the Controller variables that were saved on the clipboard are imported to the SECS/GEM Configurator.

If the names of any of the Controller variables on the clipboard are already registered in the SECS/GEM Configurator but the data type, Retain attribute, or Constant attribute is different, the Controller variables are input with “\_Copy” added to the end of the variable names.



### **Precautions for Correct Use**

---

The following Controller variables cannot be imported. Even if there are Controller variables that cannot be imported, an error message is not displayed and the Controller variables that can be imported are imported.

- Controller variables with more than 127 characters in the variable name
  - Controller variables with prohibited characters in the variable name
  - Controller variables with data types that cannot be used in the Controller variable definitions
  - A Controller variable with a text string that is neither TRUE nor FALSE for the Retain attribute
  - A Controller variable with a text string that is neither TRUE nor FALSE for the Constant attribute
  - Controller variables with more than 127 characters in the comment
-

The error messages that may be displayed for this menu command are described in the following table.

Error message	Cause	Correction
The name is empty.	As given in the error message.	Enter a name for the Controller variable.
The data type is empty.	As given in the error message.	Enter a data type for the Controller variable.
A string starting with underscore cannot be used.	As given in the error message.	Change the name of the Controller variable.
A string starting with numerical value (0 to 9) cannot be used.	As given in the error message.	Change the name of the Controller variable.
The string includes a character that cannot be used. <Usable characters> 0 to 9, A to Z, a to z, _ (underscore)	As given in the error message.	Change the name of the Controller variable.
The data type name has an invalid value.	As given in the error message.	Change the data type name for the Controller variable. You cannot use spaces or two-byte characters.
The link variable name is duplicated.	As given in the error message.	Change the name of the Controller variable.
The string format is invalid.	As given in the error message.	Change the text string format for the data type of the Controller variable.
The element numbers should be specified in the order from lower to higher values.	As given in the error message.	Change the first and last element numbers of the array in the data type of the Controller variable.
The array length has an invalid format. Examples: ARRAY[0..10] OF BOOL ARRAY[0..10,0..10] OF BOOL ARRAY[0..10,0..10,0..10] OF BOOL	As given in the error message.	Change the array length format for the data type of the Controller variable.
The string format is invalid. Specify an integer between 1 and 1986.	As given in the error message.	Change the text string length for the data type of the Controller variable.
The array length is out of range. Specify a value so that the total array size does not exceed 65536.	As given in the error message.	Change the total size of the array for the data type of the Controller variable.
The set name is used for other data type.	As given in the error message.	Change the name of the Controller variable.
The specified array element is invalid. The first element must be 0.	As given in the error message.	Set the first element number of the array to 0 in the data type of the Controller variable.
A string having two or more underscores in series cannot be used.	As given in the error message.	Change the name of the Controller variable.
A string ending with underscore cannot be used	As given in the error message.	Change the name of the Controller variable.
A string starting with P_ cannot be used.	As given in the error message.	Change the name of the Controller variable.

## 8-4-5 Documentation

The Documentation Menu is used to output information on the GEM Services. This menu provides the following command.

- Documentation

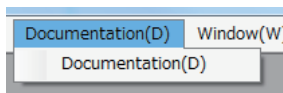

### Documentation

The **Documentation** command can be used to output the following eight types of information.

- Items
- Messages
- Equipment constants (ECVs)
- Status variables (SVs)
- Discrete variables (DVs)
- Events
- Reports
- Alarms

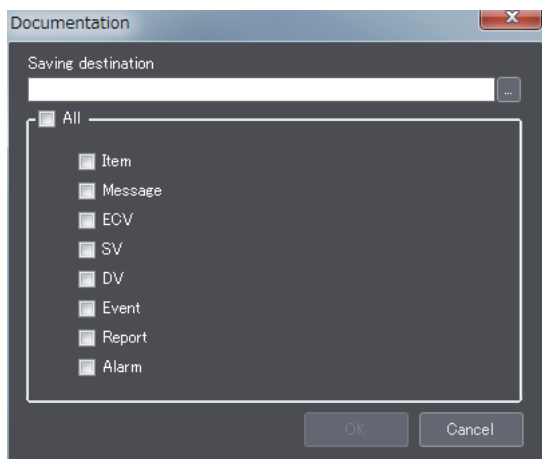

The file names and file formats for the various output files are described next.

#### ● Items

The items that are displayed in the Item Definition Dialog Box are output to the item file.

The file name is Document\_Item.txt.

The file format is given below.

Data name	<TAB>	Description	<TAB>	Format	<TAB>	Data size	<TAB>	Fixed length
ACKC5	<TAB>	Acknowledge code	<TAB>	10	<TAB>	1	<TAB>	N/A
ACKC6	<TAB>	Acknowledge code	<TAB>	10	<TAB>	1	<TAB>	N/A
		:						
		:						



## ● Messages

The items that are displayed in the GEM Standard Messages Dialog Box and User-defined Messages Dialog Box are output to the message file. The branch numbers of user-defined messages are displayed after the function code and separated from it with a hyphen.

The file name is Document\_Message.txt.

The file format is given below.

```
SF <TAB> Message name <TAB> Direction <TAB> Enable/disable <TAB> W-bit setting

S1,F1 <TAB> Are You There Request(R) <TAB> H←→E <TAB> Enable <TAB> ON
S1,F2 <TAB> On-Line Data <TAB> H←→E <TAB> Enable <TAB> OFF
S65,F65-1 <TAB> User-defined Message <TAB> H→E <TAB> ON
:
:
```

## ● Equipment Constants (ECVs)

The items that are displayed in the Equipment Constant Definition Dialog Box are output to the equipment constant (ECV) file.

The file name is Document\_ECV.txt.

The file format is given below.

```
ECID <TAB> ECNAME <TAB> Format <TAB> Data size <TAB> Link variable <TAB> Description <TAB>
ECMAX <TAB> ECMIN <TAB> ECDEF <TAB> UNITS <TAB> Fixed length

1 <TAB> EstablishCommunicationsTimeout <TAB> 52 <TAB> 1 <TAB>
_GEM_EstblishCommunicationsTimeout <TAB> Used to initialize between attempt to resend <TAB> 256
<TAB> 1 <TAB> 60 <TAB> s <TAB> N/A
:
:
```

## ● Status Variables (SVs)

The items that are displayed in the Status Variable Definition Dialog Box are output to the status variable (SV) file.

The file name is Document\_SV.txt.

The file format is given below.

```
SVID <TAB> SVNAME <TAB> Format <TAB> Data size <TAB> Link variable <TAB> Description <TAB>
UNITS <TAB> Fixed length <TAB> Trace target <TAB> Limit monitoring target <TAB> LIMIT MIN <TAB>
LIMITMAX <TAB> CEID

102 <TAB> CLOCK <TAB> 20 <TAB> 16 <TAB> N/A <TAB> This status variable contains the code which
identifies the current control state of the equipment
<TAB> N/A <TAB> Enable <TAB> OFF <TAB> N/A <TAB> N/A <TAB> N/A
:
:
```

### ● Discrete Variables (DVs)

The items that are displayed in the Discrete Variable Definition Dialog Box are output to the discrete variable (DV) file.

The file name is Document\_DV.txt.

The file format is given below.

```
DVID <TAB> DVNAME <TAB> Format <TAB> Link variable <TAB> Description <TAB> Data size <TAB>
Description <TAB> Fixed length

304 <TAB> PPChangeName <TAB> 20 <TAB> 80 <TAB> _GEM_PPChangeInfo.PPChangeName <TAB>
N/A <TAB> The PPID which was affected upon the event of the creation, editing, or deletion of a Process
Program local to the equipment <TAB>Disable

      :
      :
```

### ● Events

The items that are displayed in the Event Definition Dialog Box are output to the event file.

The file name is Document\_Event.txt.

The file format is given below.

```
CEID <TAB> Event name <TAB> Linked RPTID*1 <TAB> Enable/disableCEID

1 <TAB> Equipment Off-Line <TAB> 1<TAB>Enable

      :
      :
```

\*1. If there is more than one linked RPTID registered, they are given and separated by commas. Example: 1,2

### ● Reports

The items that are displayed in the Report Definition Dialog Box are output to the report file.

The file name is Document\_Report.txt.

The file format is given below.

```
RPTID <TAB> Report name <TAB> Structure

1 <TAB> Control State Change Report <TAB> "L,2<CR>1.<ControlState><CR>2<Clock>" <TAB>

      :
      :
```

### ● Alarms

The items that are displayed in the Alarm Definition Dialog Box are output to the alarm file.

The file name is Document\_Alarm.txt.

The file format is given below.

```
ALID <TAB> ALCD <TAB> ALTX<TAB> CEID on Alarm Set <TAB> CEID on Alarm Clear

1 <TAB> 0 <TAB> Unit 1 exhaust pressure error <TAB> 1001 <TAB> 1002

      :
      :
```

The error messages that may be displayed for this menu command are described in the following table.

Error message	Cause	Correction
The folder specified as the saving destination does not exist.	As given in the error message.	Specify a folder that exists on the computer or create the specified folder before you apply the setting.
The path name includes invalid character(s). The following characters cannot be used: ex. * ? " < >	As given in the error message.	Change the path name.
The path name for saving destination cannot exceed 128 characters.	As given in the error message.	Correct the saving destination.

## 8-4-6 Window

The Window Menu is used to arrange the dialog boxes that are displayed in the editing area. This menu provides the following two commands.

- Cascade
- Close All

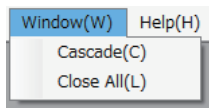

### Cascade

The **Cascade** command is used to cascade the dialog boxes in the editing area. When you execute this command, the dialog boxes are displayed as shown below.

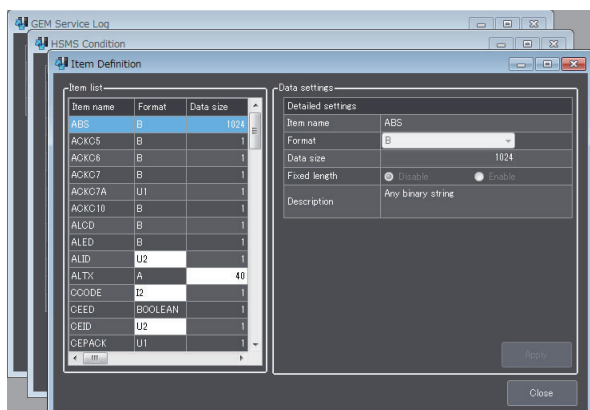

### Close All

The **Close All** command is used to close all of the dialog boxes in the editing area.

## 8-4-7 Help

The Help Menu is used to display version information. This menu provides the following command.

- About Software

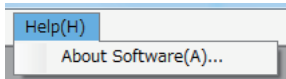

### About Software

The **About Software** command displays version information on the SECS/GEM Configurator. The following version information is displayed.

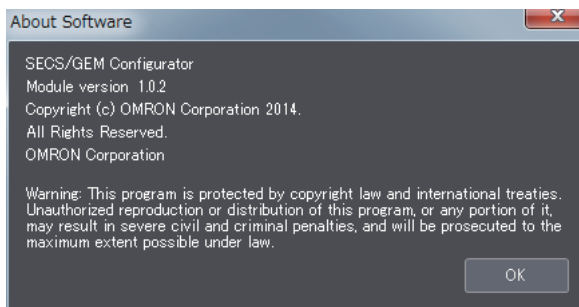

## 8-5 Toolbar Configuration

---

The toolbar displays icons for the following menu bar commands: **New**, **Open**, and **Save**. The following icons are used for these three commands.

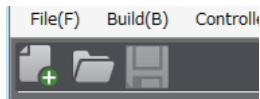

### ● New Icon

The following icon is used for the **New** command.



The function of the New Icon is the same as the New command on the File Menu. Refer to *New* on page 8-16 for details.

### ● Open Icon

The following icon is used for the **Open** command.



The function of the Open Icon is the same as the Open command on the File Menu. Refer to *Open* on page 8-17 for details.

### ● Save Icon

The following icon is used for the **Save** command.



The function of the Save Icon is the same as the Save command on the File Menu. Refer to *Save* on page 8-17 for details.

## 8-6 Basic Operations on the List Menus

The list menus are used to make settings for GEM Services. The following seven menus are provided at the top level of the menu structure.

- Configuration
- HSMS Settings
- Data Definition
- Model Settings
- GEM Capability Settings
- Message Settings
- Confirm Settings

Before we describe the individual items on the list menus, we will describe the dialog box configuration and operating methods that are the same for all of the list menus.

### 8-6-1 List Menu Dialog Boxes

There are the following two types of List Menu Dialog Boxes.

- Setting Dialog Boxes  
A setting dialog box is displayed in the editing area if you select a top-level list menu. You can select the tab pages and make settings other than those for Controller variables.
- Variable Dialog Boxes  
If you click a variable name box in any of the setting dialog boxes, a variable dialog box is displayed. These dialog boxes are used to create Controller variables or link them to other variables.

## 8-6-2 Setting Dialog Boxes

The configuration of the setting dialog boxes is shown below.

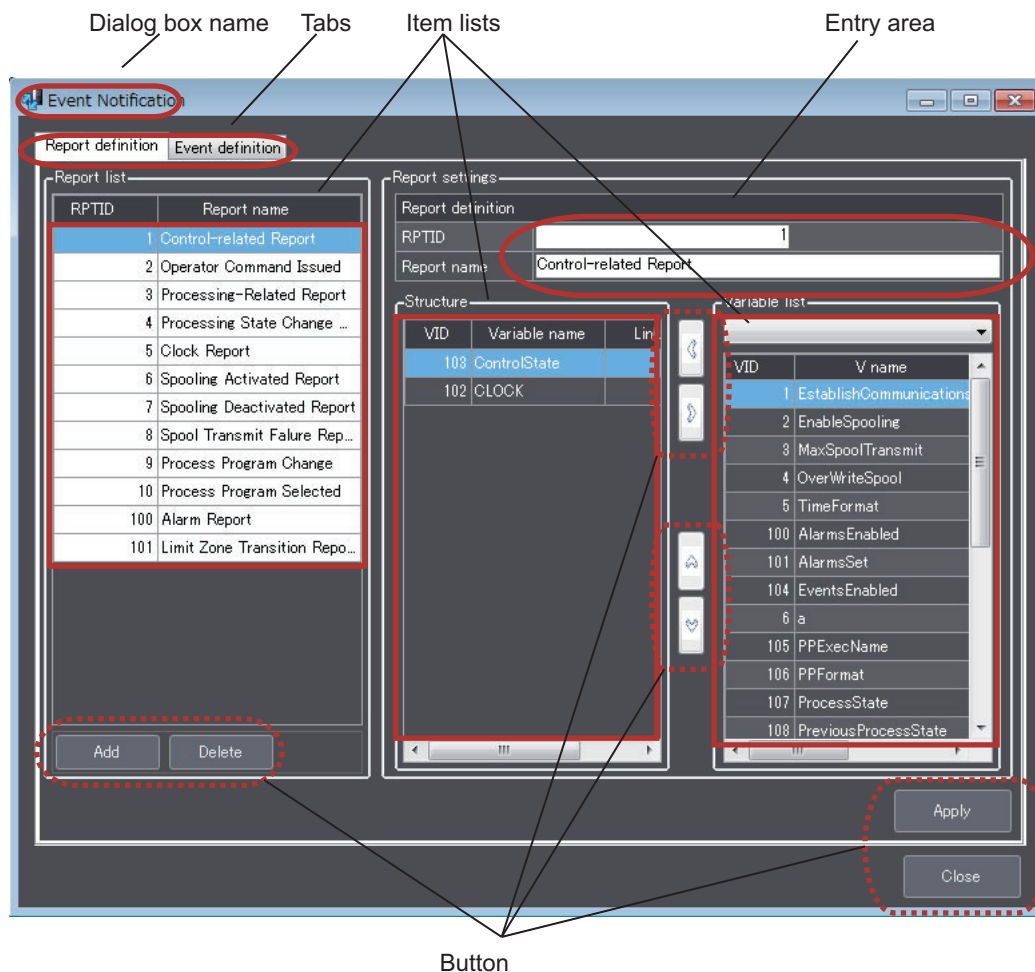

### ● Dialog Box Name

The name of the setting dialog box. The dialog box name is the same as the top-level list menu name.

### ● Tabs

If there is more than one type of item that can be set on the setting dialog box, you can select a tab to change the display. Not all setting dialog boxes have tabs.

### ● Item Lists

Items such as report names and event names are displayed in lists. You can click the column titles to sort the rows in ascending or descending order. The highlighted item in a list is the item that is currently selected.

### ● Entry Area

In this area, you can click into the boxes to directly enter numbers or text strings.



## ● Button

The buttons are used to perform various operations. The buttons that are displayed are shown in the following table.

Button	Function
Apply	Enables the settings in the currently displayed dialog box. If you close a dialog box or change the tab page without clicking the <b>Apply</b> Button, the settings that were made on the relevant dialog box are discarded.
Add	Adds a new row to an item list.
Delete	Deletes the selected row from an item list.
Copy	Adds a row with the same contents as the selected row to an item list. Use this button to create a new item by changing only some of the settings of an existing item.
Close	Closes the currently displayed dialog box.
< and >	These buttons are used to move items between two lists that are displayed side by side.
^ and v	These buttons are used to move the selected item up and down in the list.

### 8-6-3 Variable Dialog Boxes

The variable dialog boxes are displayed when link variable names are clicked in the setting dialog boxes. These dialog boxes are used to link previously created Controller variables to other variables.

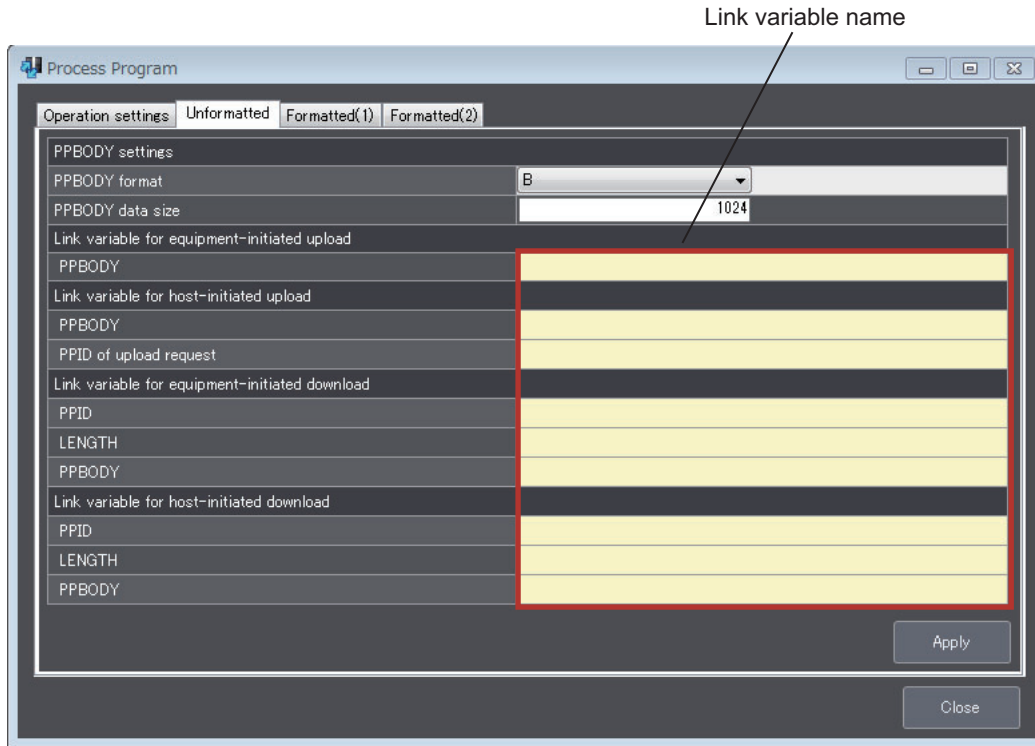

The configuration of the variable dialog boxes is shown below.

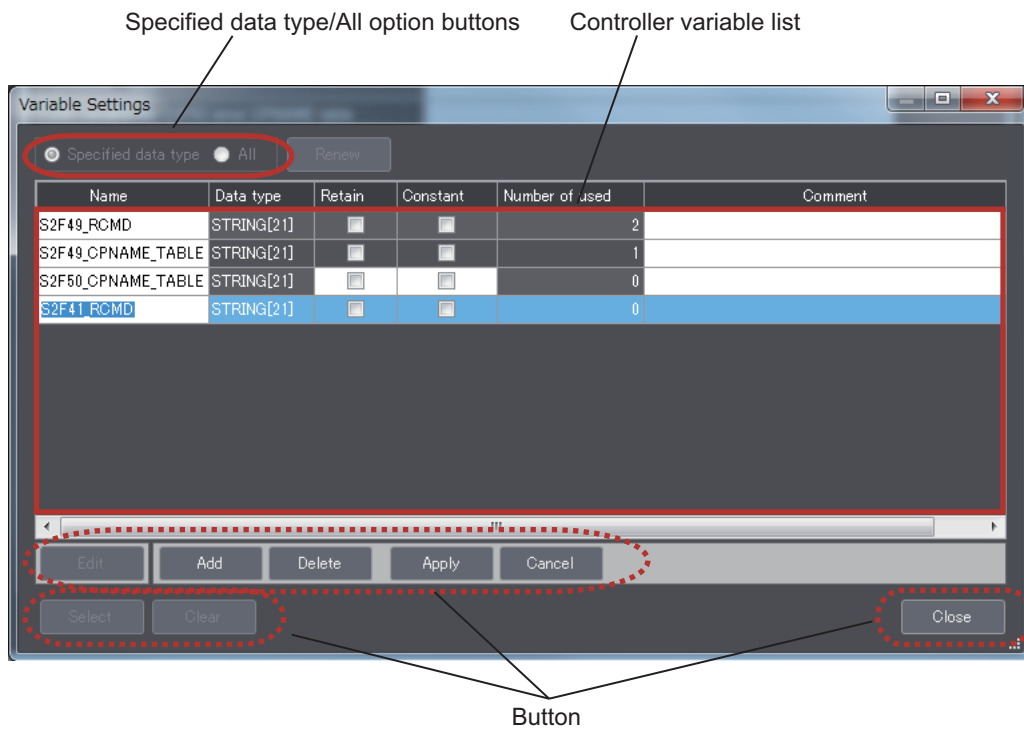

## ● Specified Data Type/All Option Buttons

The option that is selected determines the items that are displayed in the Controller variable list. Select an option and click the **Renew** Button to change the display.

Button	Controller variable list display
Specified data type	Of the Controller variables that are registered in the project, only the Controller variables that have the same data types, Constant attributes, and Retain attributes as the linked variables are displayed.* <sup>1</sup>
All	All of the Controller variables that are registered in the project are displayed.

\*1. Refer to 2-3-3 *Link Variables* on page 2-14 for information on the Constant attribute and Retain attribute of link variables.

## ● Controller Variable List

The Controller variables are displayed. You can click the column titles of the Controller variable attributes to sort the rows in ascending or descending order. The highlighted item in a Controller variable list is the Controller variable that is currently being selected.

The following table gives the meanings of the attributes of the Controller variables.

Attribute	Meaning
Name	The name of the Controller variable.
Data type	The data type of the Controller variable.
Retain	The Retain attribute of the Controller variable.
Constant	The Constant attribute of the Controller variable.
Number of used	The number of registrations as a link variable.
Comment	The user can enter a description of the Controller variable.



### Precautions for Correct Use

If a Controller variable is set for more than one link variable, the number of used attributes is set to 2 or higher. An error will not occur in the user program, but the intended operation may not be achieved. Always keep the number of used attributes at 0 or 1.

## ● Button

The buttons are used to perform various operations. The buttons that are displayed are shown in the following table.

Button	Function
Edit	Enables editing the attributes of the selected Controller variable. When you click the <b>Edit</b> Button, the <b>Add</b> , <b>Delete</b> , <b>Apply</b> , and <b>Cancel</b> Buttons are enabled.
Add	Adds a row to the Controller variable list.
Delete	Deletes the selected row from a Controller variable list.
Apply	Enables the settings in the currently displayed dialog box. If you close a dialog box without clicking the <b>Apply</b> Button, the settings that were made on the relevant dialog box are discarded.
Cancel	Discards the changes made in editing.
Select	Links the selected Controller variable to a variable.
Close	Closes the dialog box.



### Precautions for Correct Use

If you delete a Controller variable that is linked to another variable, the link to the other variable is also deleted. If you change the attributes of a Controller variable that is linked to another variable, the link to the other variable may also be deleted.

## 8-7 Configuration

The Configuration Menu is used to make settings for the GEM Service logs. This menu provides the following command.

- GEM Service Log

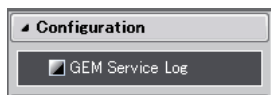

### 8-7-1 GEM Service Log

The **GEM Service Log** command is used to set the numbers of records in the HSMS communications log, SECS message log, and execution log.

For details on the GEM Service logs, refer to *Section 6 GEM Service Logs*.

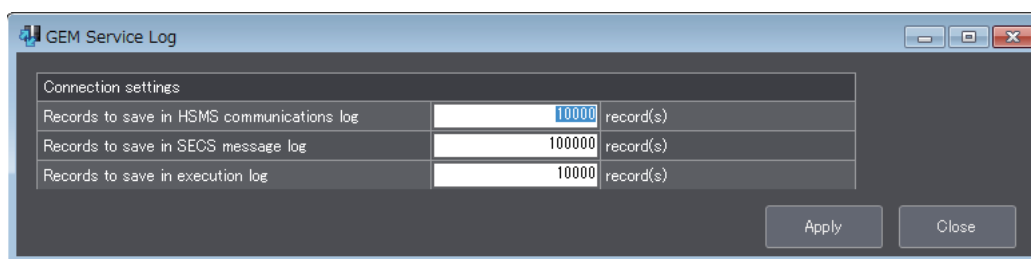

The items that are displayed in the GEM Service Log Dialog Box are described in the following table along with the meanings and value ranges of the items.

Item	Meaning	Range of values
Connection settings		
Records to save in HSMS communications log	Sets the maximum number of records to save in the HSMS communications log in increments of 100 records.* <sup>1</sup>	0-100,000
Records to save in SECS message log	Sets the maximum number of records to save in the SECS message log in increments of 100 records.* <sup>1</sup>	0-1,000,000
Records to save in execution log	Sets the maximum number of records to save in the execution log in increments of 100 records.* <sup>1</sup>	0-100,000

\*1. Records are not saved in the logs if you set 0.

The error messages that may be displayed for this menu command are described in the following table.

Error message	Cause	Correction
An entry is empty.	As given in the error message.	Set all of the items.
The entered value is out of the specified range.	As given in the error message.	Set a value within the valid setting range.
Set it in units of 100.	As given in the error message.	Set the value to a multiple of 100.

# 8-8 HSMS Settings

The HSMS Settings Menu is used to set the conditions for HSMS communications between the host and CPU Unit. This menu provides the following command.

- HSMS Condition



## 8-8-1 HSMS Condition

The **HSMS Condition** command is used to set the conditions for HSMS communications between the host and CPU Unit.

Refer to 5-2 *HSMS Communications* on page 5-14 for details on HSMS communications.

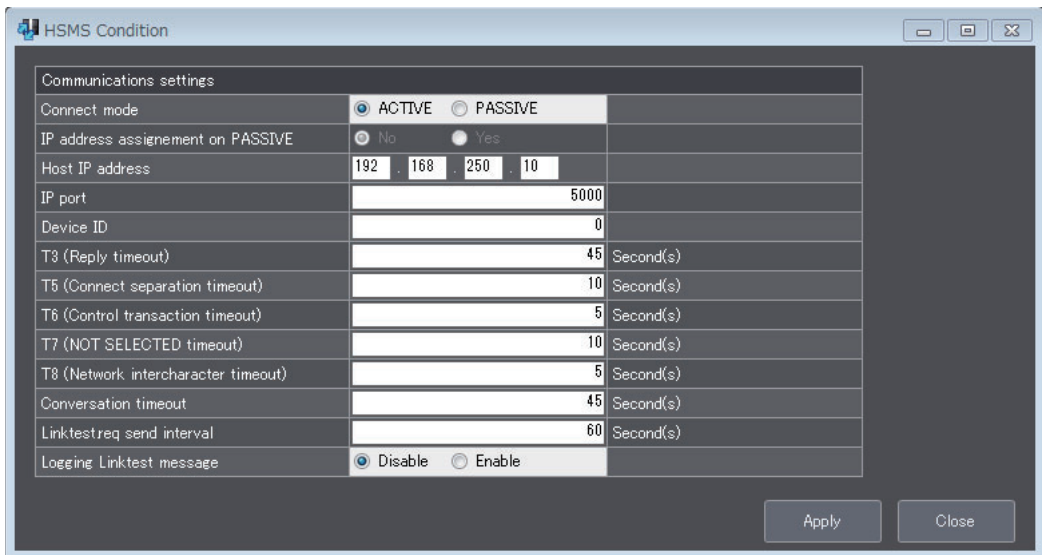

The items that are displayed in the HSMS Condition Dialog Box are described in the following table along with the meanings and value ranges of the items.

Item	Meaning	Range of values
Communications settings		
Connect mode	The connect mode that is used to open HSMS communications.	Active/ Passive
IP address assignment on PASSIVE	Specifies whether to set a Controller IP address when the connect mode is set to passive.	No/Yes
Host IP address	The IP address of the host. If the TCP/IP connect mode is set to active, this is the IP address of the host to which to send connection requests. If the TCP/IP connect mode is set to passive and specifying an IP address for passive connections has been set, this is the IP address of the host from which to accept connection requests.	Any value except for 0.0.0.0 and 255.255.255.255
IP port	If the TCP/IP connect mode is set to active, this is the host TCP port number. If the TCP/IP connect mode is set to passive, this is the Controller TCP port number.*1	1-65535
Device ID	The device ID that is attached to the header of SECS-II messages.	0-65535
T3 (Reply timeout)	T3 (reply timeout) [s].	1-120
T5 (Connect separation timeout)	T5 (connect separation timeout) [s]. This is the minimum time interval for an entity to cancel a TCP/IP connection.	1-240
T6 (Control transaction timeout)	T6 (control transaction timeout) [s]. The maximum time that an HSMS control connection can remain open until it is assumed that a communications error occurred.	1-240
T7 (NOT SELECTED timeout)	T7 (NOT SELECTED timeout) [s]. The time after a TCP/IP connection is established until it is assumed that a communications error occurred.	1-240
T8 (Network intercharacter timeout)	T8 (network intercharacter timeout) [s]. The maximum time until it is assumed that a communications error occurred. This is the time between receiving consecutive bytes of one complete HSMS message.	1-240
Conversation timeout	This is the timeout value in seconds until the expected transaction is received for specific transactions.	1-240
Linktest.req send interval	The send interval for Linktest messages [s].	0-65535
Logging Linktest message	Specifies whether to record Linktest records in the HSMS communications log.	Enabled/disabled

\*1. You cannot specify port numbers that are reserved by the system. Refer to the *NJ/NX-series CPU Unit Built-in EtherNet/IP User's Manual* (Cat. No. W506) for details.

The error messages that may be displayed for this menu command are described in the following table.

Error message	Cause	Correction
An entry is empty.	As given in the error message.	Set all of the items.
The entered value is out of the specified range.	As given in the error message.	Set a value within the valid setting range.
The set IP address is invalid.	As given in the error message.	Change the IP address.
The set IP port is reserved for the xxxx.	The set IP port is reserved for another application.*1	Change the port number of the IP port.

\*1. Refer to the *NJ/NX-series Built-in EtherNet/IP User's Manual* (Cat. No. W506) for details.

# 8-9 Data Definition

The Data Definition Menu is used to define items, equipment constants (ECs), status variables (SVs), and discrete variables (DVs). This menu provides the following four commands.

- Item
- Equipment Constant (EC)
- Status Variable (SV)
- Discrete Variable (DV)

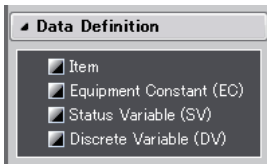

## 8-9-1 Item

The **Item** command is used to define items.

Refer to *5-3 Item Definitions* on page 5-17 for details on item definitions.

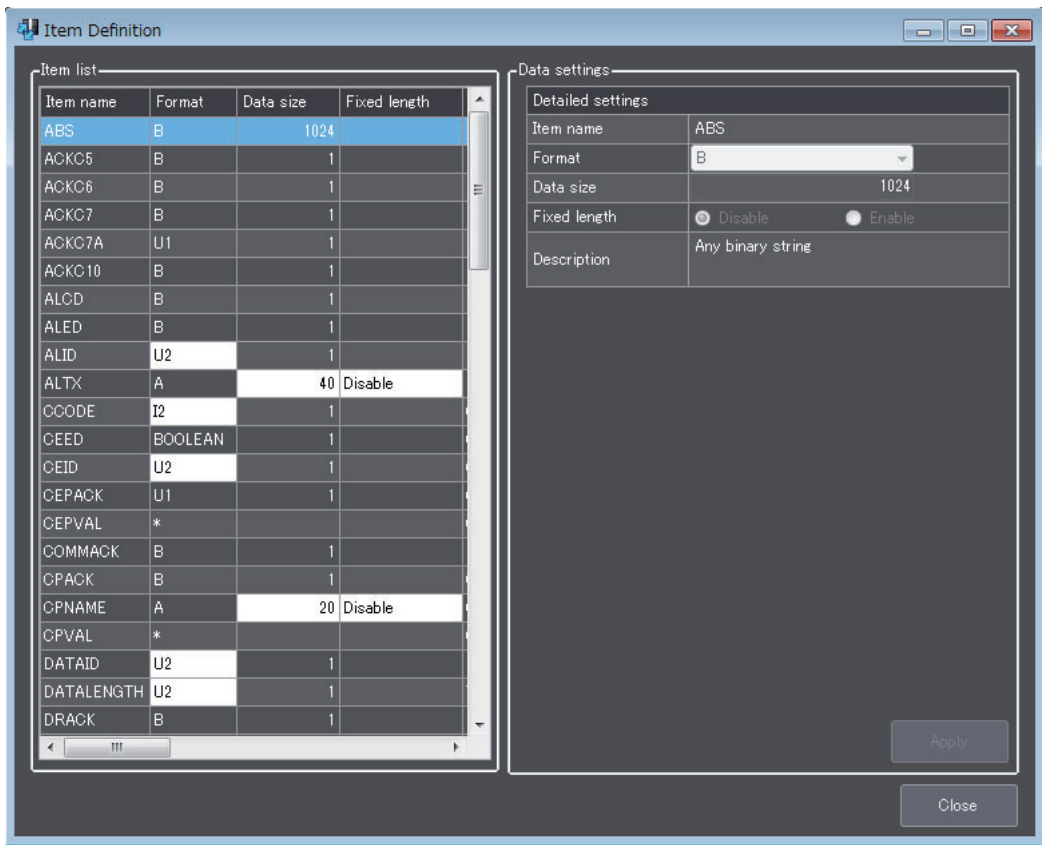

The data settings that are displayed in the Item Definition Dialog Box are described in the following table along with the meanings and value ranges of the settings.

Item	Meaning	Range of values
Detailed settings		
Item name	The name of the item.	---
Format	The format of the item. The format cannot be changed for items that have only one format specified in the SECS/GEM standards.	Depends on the item setting range.
Data size	The size of the data in bytes. The data size cannot be changed for items that have only one data size specified in the SECS/GEM standards.	Depends on the item setting range.
Fixed length	Specifies whether to use a fixed data size or a variable data size for format A. Enable: Fixed length* <sup>1</sup> Disable: Variable length	Enable/disable
Description	A description of the item that is entered by the user.	Single-byte characters: 128 characters max. Double-byte characters: 64 characters max.

\*1. If a fixed length is specified, spaces are added for items that are smaller than the data size.

You can click an item name to sort the list by that item.

The error messages that may be displayed for this menu command are described in the following table.

Error message	Cause	Correction
An entry is empty.	As given in the error message.	Set all of the items.
The entered value is out of the specified range. [Range: xxxx to yyyy]	As given in the error message.	Set a value within the valid setting range.



### 8-9-2 Equipment Constant (EC)

The **Equipment Constant (EC)** command is used to define equipment constants (ECs). You can edit, add, or delete equipment constants.

Refer to *5-4 Variable Data Definitions* on page 5-21 for details on equipment constant (EC) definitions.

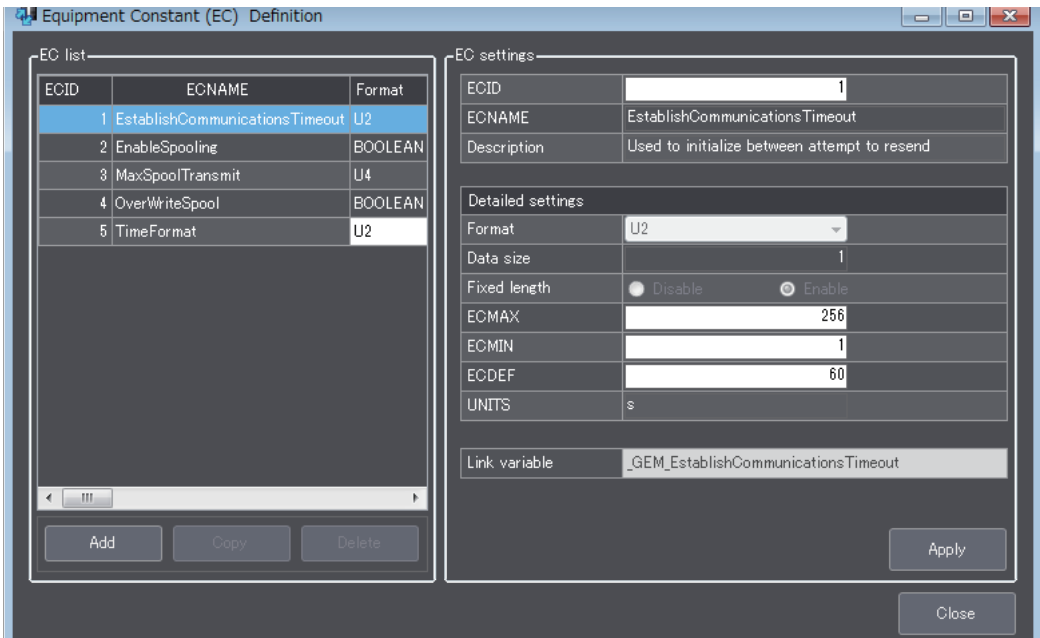

The EC settings that are displayed in the Equipment Constants (EC) Definition Dialog Box are described in the following table along with the meanings and value ranges of the settings.

Item	Meaning	Range of values
ECID	The equipment constant ID.	Depends on the format that is set for the VID in the item definitions. You cannot set the ECID to 0.
ECNAME	The equipment constant name. You cannot change equipment constants that are defined in the SECS/GEM standards.	Alphanumerics The maximum data size is the data size specified for the ECNAME in the item definitions.
Description	A description of the equipment constant that is entered by the user. You cannot change equipment constants that are defined in the SECS/GEM standards.	Single-byte characters: 128 characters max. Double-byte characters: 64 characters max.
Detailed settings		
Format	The format of the equipment constant. The format cannot be changed for equipment constants that have only one format specified in the SECS/GEM standards.	B, BOOLEAN, A, I1, I2, I4, F4, F8, U1, U2, or U4
Data size	The data size in bytes for format B or A. The data size cannot be changed for equipment constants that have only one data size specified in the SECS/GEM standards.	1-120
Fixed length	Specifies whether to use a fixed data size or a variable data size for format A. Enable: Fixed length <sup>*1</sup> Disable: Variable length	Enable/disable
ECMAX	The maximum value that can be set.	Depends on the format. This is the upper limit for verifying the value for New Equipment Constant Send (S2,F15). <sup>*2</sup>
ECCMIN	The minimum value that can be set.	Depends on the format. This is the lower limit for verifying the value for New Equipment Constant Send (S2,F15). <sup>*3</sup>
ECDEF	The default value when the system is started.	Depends on the format, EXMAX, and ECCMIN.
UNITS	The unit of the value. You cannot change equipment constants that are defined in the SECS/GEM standards.	The maximum value is the data size set for UNITS in the item definitions.
Link variable	The variable that is linked to the equipment constant. You cannot change equipment constants that are defined in the SECS/GEM standards.	---

\*1. If a fixed length is specified, spaces are added for equipment constants that are smaller than the data size.

\*2. This value is not used for verifying the value for New Equipment Constant Send (S2,F15) for format B or A. Only the value of the ECGMAX item is used for Equipment Constant Namelist (S2,F30). For format B, enter the limit with one byte.

\*3. This value is not used for verifying the value for New Equipment Constant Send (S2,F15) for format B or A. Only the value of the ECCMIN item is used for Equipment Constant Namelist (S2,F30). For format B, enter the limit with one byte.

You can click an item name to sort the list by that item.

The error messages that may be displayed for this menu command are described in the following table.

Error message	Cause	Correction
An entry is empty.	As given in the error message.	Set all of the items.
The entered value is out of the specified range. [Range: xxxx to yyyy]	As given in the error message.	Set a value within the valid setting range.
An ECID is duplicated.	As given in the error message.	Change the value of the ECID.
An entry may be over the valid input range. [Valid input range: xx characters or less]	As given in the error message.	Make the setting within the maximum number of characters.
An ECNAME includes a character that cannot be used. <Usable characters> 0 to 9, A to Z, a to z, _ (underscore), - (hyphen)	As given in the error message.	Change the setting of ECNAME.
An ECNAME is duplicated.	As given in the error message.	Change the setting of ECNAME.
The input value in the binary (B) format is not a hexadecimal character. <Hexadecimal characters> Any combination of characters among 0 to 9, a to f, and A to F in units of two characters.	As given in the error message.	Enter a hexadecimal number.
The input value in binary (B) format does not agree with the data size.	As given in the error message.	Specify a hexadecimal number that is twice the data size.
The value includes a character that cannot be used for integer type (I and U). 0 to 9, - (hyphen) [for U only]	As given in the error message.	Set only usable characters.
The value includes a character that cannot be used for floating-point type. Or, the entered value exceeds the valid range. <Usable characters> 0 to 9, - (hyphen), . (decimal point)	As given in the error message.	Set only usable characters.
A link variable is not specified	As given in the error message.	Specify a link variable.
The value specified to the minimum value is bigger than the maximum value.	As given in the error message.	Set a minimum value that is smaller than the maximum value.
The link variable is already used for other variable data (EC, SV or DV).	As given in the error message.	Change the link variable.

### 8-9-3 Status Variable (SV)

The **Status Variable (SV)** command is used to define status variables (SVs). You can edit, add, or delete status variables.

Refer to *5-4 Variable Data Definitions* on page 5-21 for details on status variable (SV) definitions.

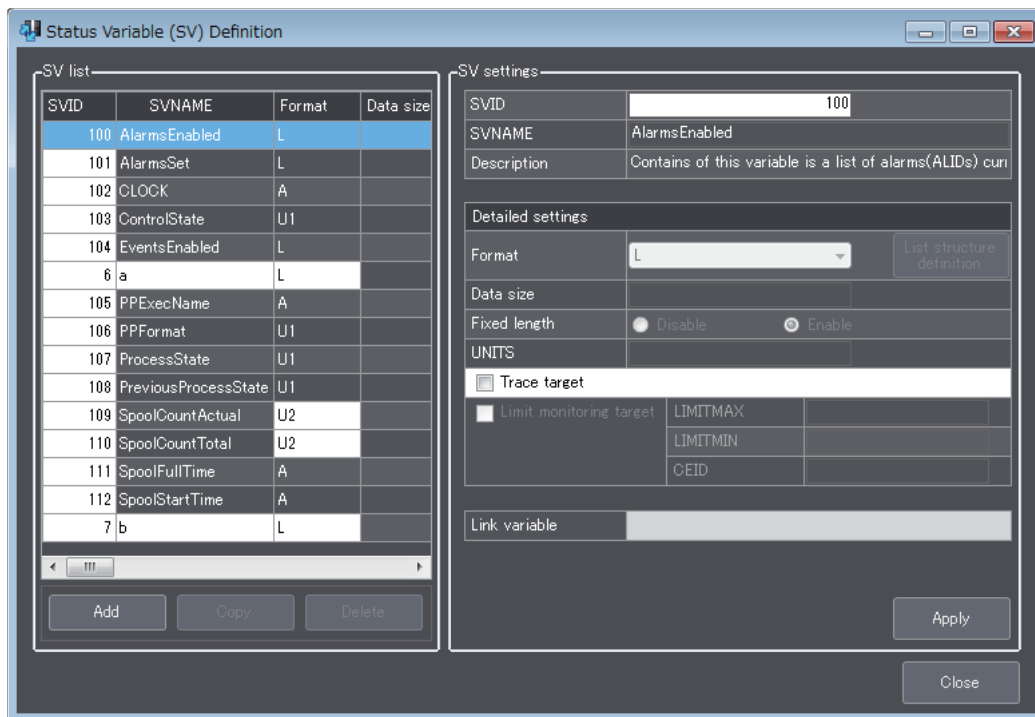

The SV settings that are displayed in the Status Variable (SV) Definition Dialog Box are described in the following table along with the meanings and value ranges of the settings.

Item	Meaning	Range of values
SVID	The status variable ID.	Depends on the format that is set for the VID in the item definitions. You cannot set the SVID to 0.
SVNAME	The status variable name. You cannot change status variables that are defined in the SECS/GEM standards.	Alphanumerics The maximum data size is the data size specified for the SVNAME in the item definitions.
Description	A description of the status variable that is entered by the user. You cannot change status variables that are defined in the SECS/GEM standards.	Single-byte characters: 128 characters max. Double-byte characters: 64 characters max.
Detailed settings		
Format	The format of the status variable. The format cannot be changed for status variables that have only one format specified in GEM. Set a list structure definition for format L.* <sup>1</sup> The maximum number of lists is 64. The maximum number of nesting levels is 3.	L, B, BOOLEAN, A, I1, I2, I4, F4, F8, U1, U2, or U4
Data size	Data size [bytes] For format A or B, specify the data length. For formats other than A and B, specify the number of elements. The data size cannot be changed for status variables that have only one data size specified in the SECS/GEM standards.	Format A or B: 1 to 120 bytes Formats other than A and B: 1 to 32 items
Fixed length	Specifies whether to use a fixed data size or a variable data size for format A. Enable: Fixed length* <sup>2</sup> Disable: Variable length	Enable/disable
UNITS	The unit of the value. You cannot change status variables that are defined in the SECS/GEM standards.	The maximum value is the data size set for UNITS in the item definitions.
Trace target	Specifies targets for trace data collection.	Target or not a target.
Limit monitoring target	Specifies targets for limit monitoring. Specifying a limit monitoring target is not possible for status variables with formats L, A, or B or for status variables with numeric formats with multiple elements.	Target or not a target.
LIMITMAX	The maximum value of the status variable when it is specified as a limit monitoring target.	Depends on the format of the monitored SV.
LIMITMIN	The minimum value of the status variable when it is specified as a limit monitoring target.	Depends on the format of the monitored SV.
CEID	The CEID of the Limit Zone Transition event.	Depends on the format of CEID. You cannot set the CEID to 0.
Link variable	The variable that is linked to the status variable. You cannot change status variables that are defined in the SECS/GEM standards.	---

\*1. Refer to 5-4 *Variable Data Definitions* on page 5-21 for the setting methods for list structure definitions.

\*2. If a fixed length is specified, spaces are added for status variables that are smaller than the data size.

The error messages that may be displayed for this menu command are described in the following table.

Error message	Cause	Correction
An entry is empty.	As given in the error message.	Set all of the items.
The entered value is out of the specified range. [Range: xxxx to yyyy]	As given in the error message.	Set a value within the valid setting range.
A SVID is duplicated.	As given in the error message.	Change the value of the SVID.
An entry may be over the valid input range. [Valid input range: xx characters or less]	As given in the error message.	Make the setting within the maximum number of characters.
A SVNAME includes a character that cannot be used. <Usable characters> 0 to 9, A to Z, a to z, _ (underscore), - (hyphen)	As given in the error message.	Change the setting of SVNAME.
A SVNAME is duplicated.	As given in the error message.	Change the setting of SVNAME.
A link variable is not specified	As given in the error message.	Specify a link variable.
The CEID xxxx for the Limit monitoring is duplicated.	As given in the error message.	Change the value of the CEID for limit monitoring.
The number of collection events exceeds the maximum.	As given in the error message.	Change the number of registered collection events.
The link variable is already used for other variable data (EC, SV or DV).	As given in the error message.	Change the link variable.
The list structure is not defined.	As given in the error message.	Define the list structure.
Specify the link variable of the list structure.	The list structure link variable is not registered.	Set the list structure.
The number of defined list structures exceeds the maximum.	There are more than 64 variables with list structures.	Change the list structure.



#### Precautions for Correct Use

If you delete a status variable that is registered in a report structure, the status variable is also deleted from the report structure.

### 8-9-4 Discrete Variable (DV)

The **Discrete Variable (DV)** command is used to define discrete variables (DVs). You can edit, add, or delete discrete variables.

Refer to *5-4 Variable Data Definitions* on page 5-21 for details on discrete variable (DV) definitions.

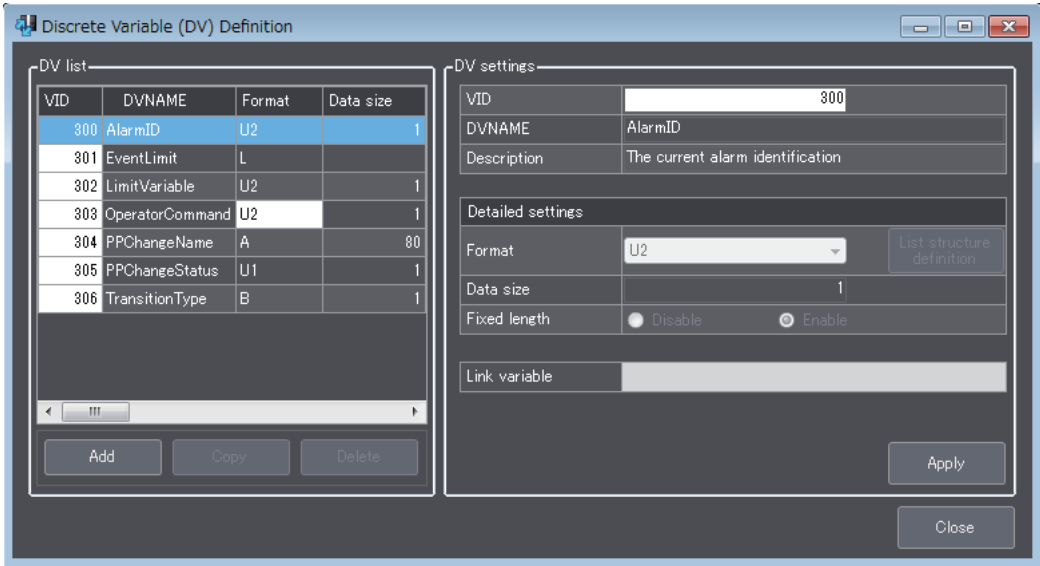

The DV settings that are displayed in the Discrete Variable (DV) Definition Dialog Box are described in the following table along with the meanings and value ranges of the settings.

Item	Meaning	Range of values
VID	The discrete variable ID.	Depends on the format that is set for the VID in the item definitions. You cannot set the VID to 0.
DVNAME	The discrete variable name. You cannot change discrete variables that are defined in the SECS/GEM standards.	Alphanumerics The maximum data size is the data size specified for the SVNAME in the item definitions.
Description	A description of the discrete variable that is entered by the user. You cannot change discrete variables that are defined in the SECS/GEM standards.	Single-byte characters: 128 characters max. Double-byte characters: 64 characters max.
Detailed settings		
Format	The format of the discrete variable. The format cannot be changed for discrete variables that have only one format specified in the SECS/GEM standards. Set a list structure definition for format L. *1 The maximum number of lists is 64. The maximum number of nesting levels is 3.	L, B, BOOLEAN, A, I1, I2, I4, F4, F8, U1, U2, or U4
Data size	Data size [bytes] For format A or B, specify the data length. For formats other than A and B, specify the number of elements. The data size cannot be changed for discrete variables that have only one data size specified in the SECS/GEM standards.	Format A or B: 1 to 120 bytes Formats other than A and B: 1 to 32 items
Fixed length	Specifies whether to use a fixed data size or a variable data size for format A. Enable: Fixed length *2 Disable: Variable length	Enable/disable
Link variable	The variable that is linked to the discrete variable. You cannot change discrete variables that are defined in the SECS/GEM standards.	---

\*1. Refer to 5-4 *Variable Data Definitions* on page 5-21 for the setting methods for list structure definitions.

\*2. If a fixed length is specified, spaces are added for discrete variables that are smaller than the data size.



The error messages that may be displayed for this menu command are described in the following table.

Error message	Cause	Correction
An entry is empty.	As given in the error message.	Set all of the items.
The entered value is out of the specified range. [Range: xxxx to yyyy]	As given in the error message.	Set a value within the valid setting range.
A VID is duplicated.	As given in the error message.	Change the value of the VID.
An entry may be over the valid input range. [Valid input range: xx characters or less]	As given in the error message.	Make the setting within the maximum number of characters.
A DVNAME includes a character that cannot be used. <Usable characters> 0 to 9, A to Z, a to z, _ (underscore), - (hyphen)	As given in the error message.	Change the setting of DVNAME.
A DVNAME is duplicated.	As given in the error message.	Change the setting of DVNAME.
A link variable is not specified	As given in the error message.	Specify a link variable.
The link variable is already used for other variable data (EC, SV or DV).	As given in the error message.	Change the link variable.
The number of defined list structures exceeds the maximum.	There are more than 64 variables with list structures.	Change the list structure.



#### Precautions for Correct Use

If you delete a discrete variable that is registered in a report structure, the discrete variable is also deleted from the report structure.

## 8-9-5 List Structure Definitions

The **List Structure Definition** command is used to define data item list structures for format L in the status variable definitions or discrete variable definitions. You can edit, add, or delete data items.

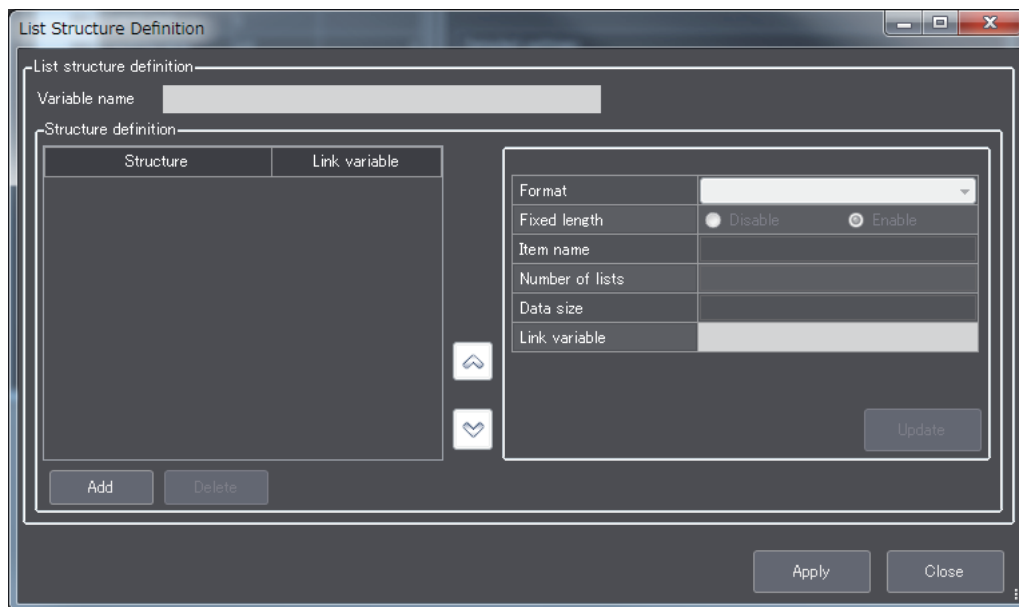

The structure settings that are displayed in the List Structure Definition Dialog Box are described in the following table along with the meanings and value ranges of the settings.

Item	Meaning	Range of values
Format	The format for each data item set in the list structure.	List of fixed length data, List of length-variable data, B, BOOLEAN, A, I1, I2, I4, F4, F8, U1, U2, or U4
Fixed length	Specifies whether to use a fixed data size or a variable data size for format A. Enable: Fixed length <sup>*1</sup> Disable: Variable length	Enable/disable
Item name	The name of the message item except for the following formats: List of fixed length data or list of length-variable data.	A to Z, a to z, and 0 to 9 20 characters max.
Number of lists	The number of lists in a list of fixed length data. The maximum number of lists in a list of length-variable data.	List of fixed length data: 0 to 64 List of length-variable data: 1 to 64
Data size	For format A or B, specify the data length. For formats other than A and B, specify the number of elements.	1-120
Link variable	The variable that is linked to the list of length-variable data or the item. There are the following two variables. <ul style="list-style-type: none"> <li>List element count<sup>*2</sup></li> <li>List element table<sup>*3</sup></li> </ul>	---

\*1. If a fixed length is specified, spaces are added for data items that are smaller than the data size.

\*2. This is the link variable for a list of length-variable data.

\*3. It is an array variable. The array element data type must agree with the format of the data items. The number of array elements must be equal to or greater than the maximum number of lists for the data items.

The items that you can set in a list structure depend on the formats of the data items. The following table shows the relationship between the data item formats and the settings in the List Structure Definition Dialog Box.

Format	Item				
	Item name	Fixed length	Number of lists	Data size	Link variable
L, fixed length			Can be set.		
L, variable length	*1		Can be set.		Can be set.
B	Can be set.			Can be set.	Can be set.
BOOLEAN	Can be set.			Can be set.	Can be set.
A	Can be set.	Can be set.		Can be set.	Can be set.
I1	Can be set.			Can be set.	Can be set.
I2	Can be set.			Can be set.	Can be set.
I4	Can be set.			Can be set.	Can be set.
F4	Can be set.			Can be set.	Can be set.
F8	Can be set.			Can be set.	Can be set.
U1	Can be set.			Can be set.	Can be set.
U2	Can be set.			Can be set.	Can be set.
U4	Can be set.			Can be set.	Can be set.

\*1. Structures of lists of length-variable data are displayed as follows: L,n (*maximum\_number\_of\_lists*).

The error messages that may be displayed for this menu command are described in the following table.

Error message	Cause	Correction
An entry is empty.	As given in the error message.	Set all of the items.
The entered value is out of the specified range. [Range: xxxx to yyyy]	As given in the error message.	Set a value within the valid setting range.
An item includes a character that cannot be used. <Usable characters> A to Z, a to z, 0 to 9	As given in the error message.	Change the data item setting.
The message structure is invalid.	As given in the error message.	Change the message structure.
The data type of the link variable is invalid.	As given in the error message.	Change the link variable or the item structure.
Plural items are specified without list structure definition.	As given in the error message.	Define the list structure.
Message levels exceed the specified nest levels.	As given in the error message.	Do not use more than three nesting levels for a message list.
The length-variable list is nested.	As given in the error message.	Do not nest lists of length-variable data.
A link variable is not specified	As given in the error message.	Specify a link variable.

## 8-10 Model Settings

The Model Setting Menu is used to define the communications state model and control state model. This menu provides the following two commands.

- Communications State Model
- Control State Model

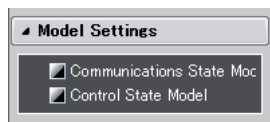

### 8-10-1 Communications State Model

The **Communications State Model** command is used to define the default communications state, the equipment model type, and the equipment software revision code in the communications state model.

Refer to *5-5-1 Communications State Model* on page 5-27 for details on the communications state model.

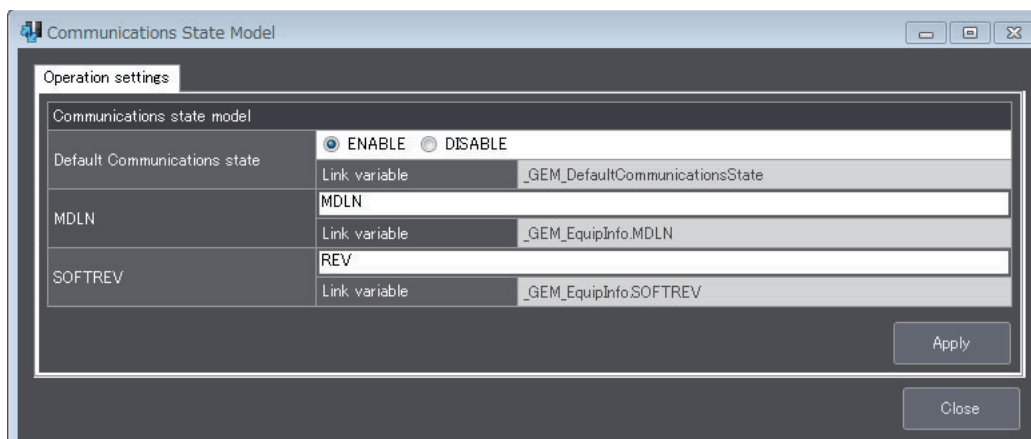

The items that are displayed in the Communications State Model Dialog Box are described in the following table along with the meanings and value ranges of the items.

Item	Meaning	Range of values
Communications State Model		
Default Communications state	The default communications state when the system is started.	ENABLE/ DISABLE
MDLN	The equipment model type.	Depends on the format of MDLN.
SOFTREV	The equipment software revision code.	Depends on the format of SOFTREV.

The error messages that may be displayed for this menu command are described in the following table.

Error message	Cause	Correction
An entry may be over the valid input range. [Valid input range: xx characters or less]	As given in the error message.	Make the setting within the maximum number of characters.

## 8-10-2 Control State Model

The **Control State Model** Menu is used to define states in the control state model.

Refer to 5-5-2 *Control State Model* on page 5-31 for details on the control state model.

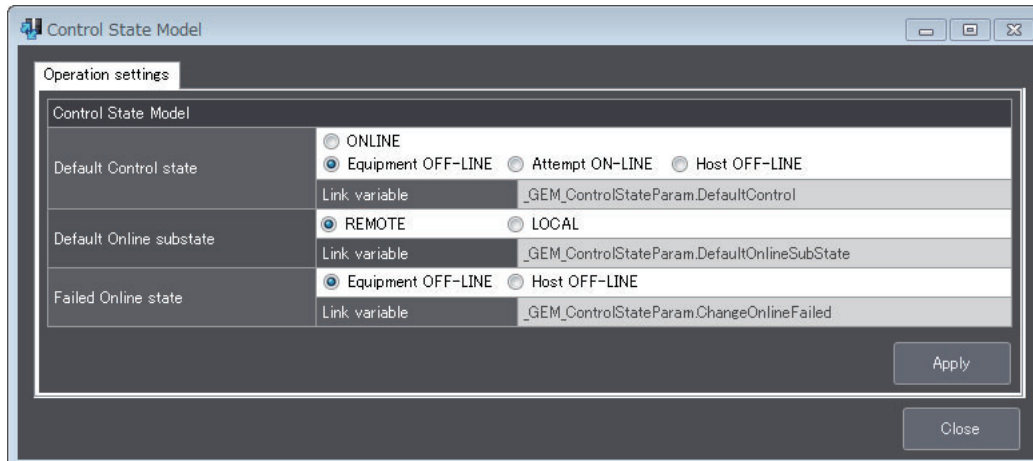

The items that are displayed in the Control State Model Dialog Box are described in the following table along with the meanings and value ranges of the items.

Item	Meaning	Range of values
Control State Model		
Default Control state	The default control state when the system is started.	ONLINE, Equipment OFF-LINE, Attempt ON-LINE, or Host OFF-LINE
Default Online substate	The substate when changing to ON-LINE when the system is started or for Request ON-LINE (S1,F17).	REMOTE or LOCAL
Failed Online state	The default state for failures to go ON-LINE.	Equipment OFF-LINE or Host OFF-LINE

## 8-11 GEM Capability Settings

---

The GEM Capability Settings Menu is used to make settings for the GEM capabilities. This menu provides the following eight commands/menus.

- Event Notification
- Alarm Management
- Remote Control
- Equipment Constants
- Process Program Management
- Equipment Terminal Service
- Limit Monitoring
- Spooling

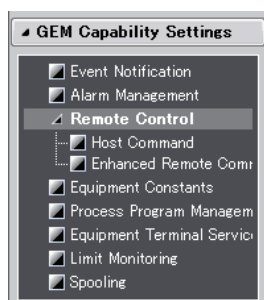

The Remote Control Menu provides the following two commands.

- Host Command
- Enhanced Remote Command

**8-11-1 Event Notification**

The **Event Notification** command is used to define the reports to link to events and the variables to include in reports when collection events occur.

Refer to 5-5-4 *Event Notification* on page 5-40 for details on event notification.

The Event Notification Dialog Box has a Report definition Tab Page to define the variables in reports and an Event definition Tab Page to define the reports to link to events.

**Report Definition Tab Page**

The Report definition Tab Page is used to define the variables to include in reports.

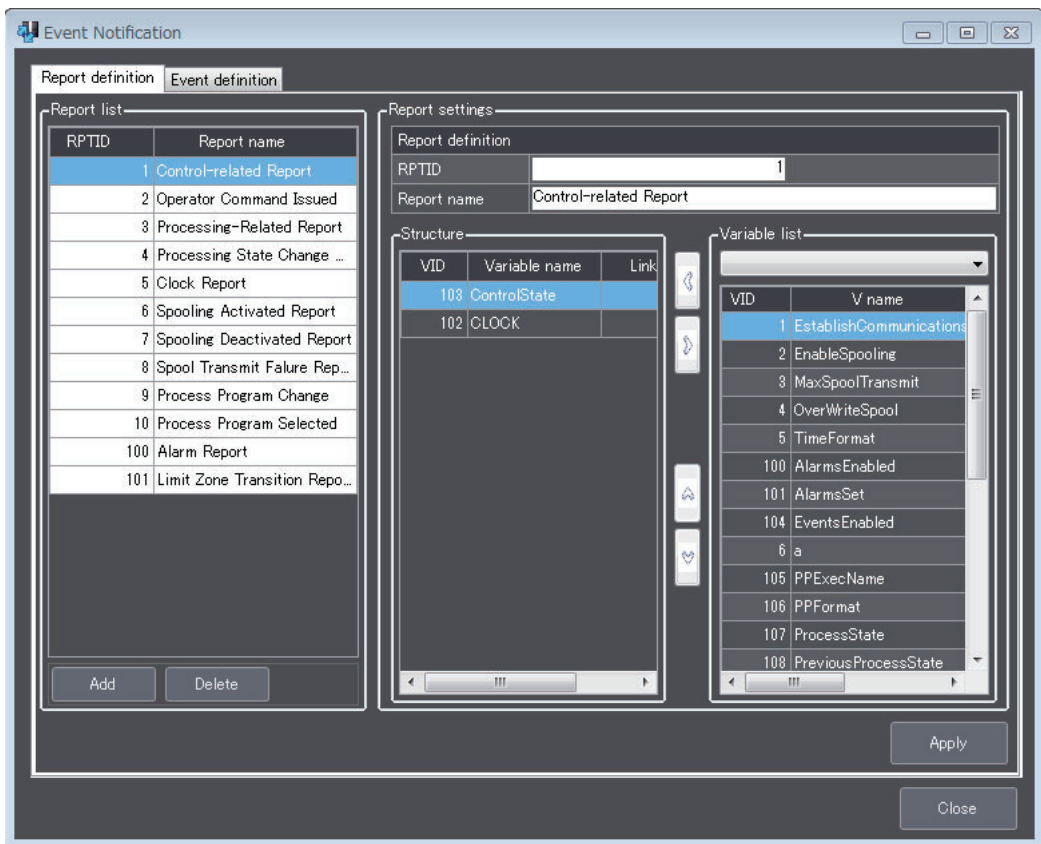

The report settings that are displayed on the Report definition Tab Page are described in the following table along with the meanings and value ranges of the settings.

Item	Meaning	Range of values
Report definition		
RPTID	RPTID	Depends on the format that is set for the RPTID in the item definitions. You cannot set the RPTID to 0.
Report name	The report name that is entered by the user.	Single-byte characters: 128 characters max. Double-byte characters: 64 characters max.
Structure	The variable data and variable data sequence of the report members.	Maximum number of members: 64

The error messages that may be displayed on this tab page are described in the following table.

Error message	Cause	Correction
An entry is empty.	As given in the error message.	Set all of the items.
The entered value is out of the specified range. [Range: xxxx to yyyy]	As given in the error message.	Set a value within the valid setting range.
A ReportID is duplicated.	As given in the error message.	Change the value of the RPTID.
An entry may be over the valid input range. [Valid input range: xx characters or less]	As given in the error message.	Make the setting within the maximum number of characters.
The number of collection events exceeds the maximum.	There are more than 256 collection event definitions.	Change the number of registered collection events.



## Event Definition Tab Page

The Event definition Tab Page is used to define the reports to link to events.

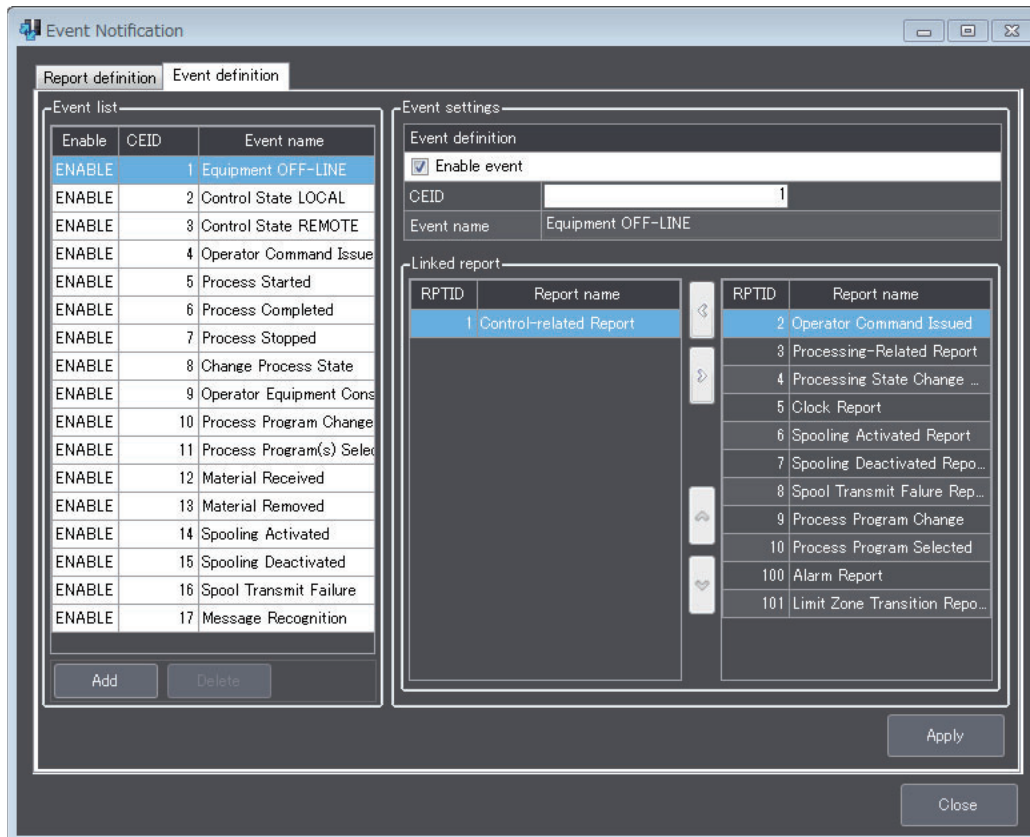

The event settings that are displayed on the Event definition Tab Page are described in the following table along with the meanings and value ranges of the settings.

Item	Meaning	Range of values
Event definition		
Enable event	Whether to enable the selected event.	Enable/disable
CEID	CEID	Depends on the format that is set for the CEID in the item definitions. You cannot set the CEID to 0.
Event name	The event name that is entered by the user.	Single-byte characters: 128 characters max. Double-byte characters: 64 characters max.
Linked report	The RPTID of the report to link to the event.	Maximum number of links: 32

In the SECS/GEM standard collection events, you cannot delete the following collection events, which are automatically issued by the GEM Services. The **Delete** Button is disabled for them.

- Control State LOCAL
- Control State REMOTE
- Spooling Activated
- Spooling Deactivated
- Spool Transmit Failure
- Alarm Detected
- Alarm Cleared
- Limit Zone Transition

The Alarm Detected and Alarm Cleared collection events are deleted if the registration of the relevant alarm is deleted.

Limit Zone Transition collection events are deleted if the limit monitoring target specification is deleted for the status variable (SV).

The error messages that may be displayed on this tab page are described in the following table.

Error message	Cause	Correction
An entry is empty.	As given in the error message.	Set all of the items.
The entered value is out of the specified range. [Range: xxxx to yyyy]	As given in the error message.	Set a value within the valid setting range.
A CEID is duplicated.	The value of the CEID is used for another collection event.	Change the value of the CEID.
An entry may be over the valid input range. [Valid input range: xx characters or less]	As given in the error message.	Make the setting within the maximum number of characters.

## Setting Collection Events

The setting procedure for collection events is described below using the Operator Equipment Constant Change collection event as an example.

The type, CEID, and report variable data for the Operator Equipment Constant Change collection event are given in the following table.

Type	Collection event	CEID	Report variable data
Equipment constant	Operator Equipment Constant Change	9	ECID

### ● Structure of Operator Equipment Constant Change Message

The message structure for the collection event is shown in the following figure. To set up a collection event, you must set the variable definition, report definition, and event definition.

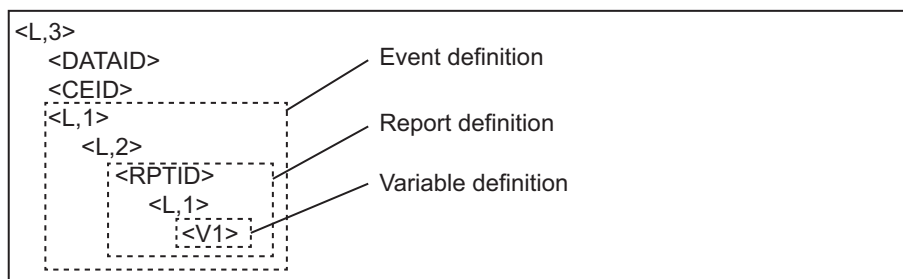

The structure of the Operator Equipment Constant Change message is defined as shown below. In the variable definition, the ECIDs changed by the operator are registered.

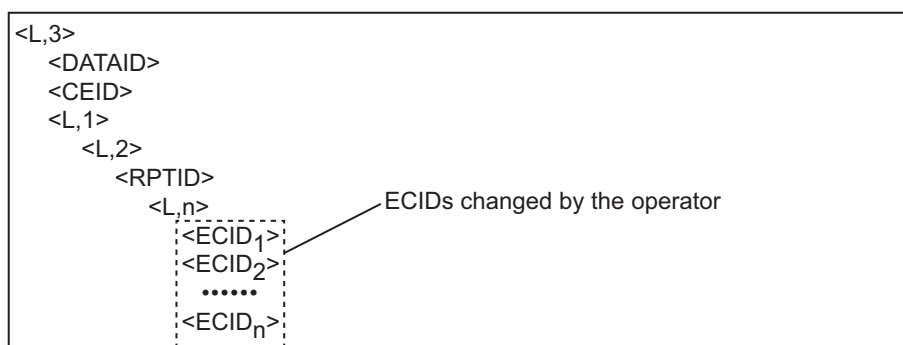

● **Setting the Variable Definition**

The variable definition in the structure of the Operator Equipment Constant Change message is set. This variable is used only in the collection event, so a discrete variable is defined. The specifications of the defined discrete variable are given in the following table.

VID	DVNAME	Description	Format
307	ECIDs	Changed ECID list	L

The following settings are made under **Data Definition – Discrete Variable Definition** in the List Menus.

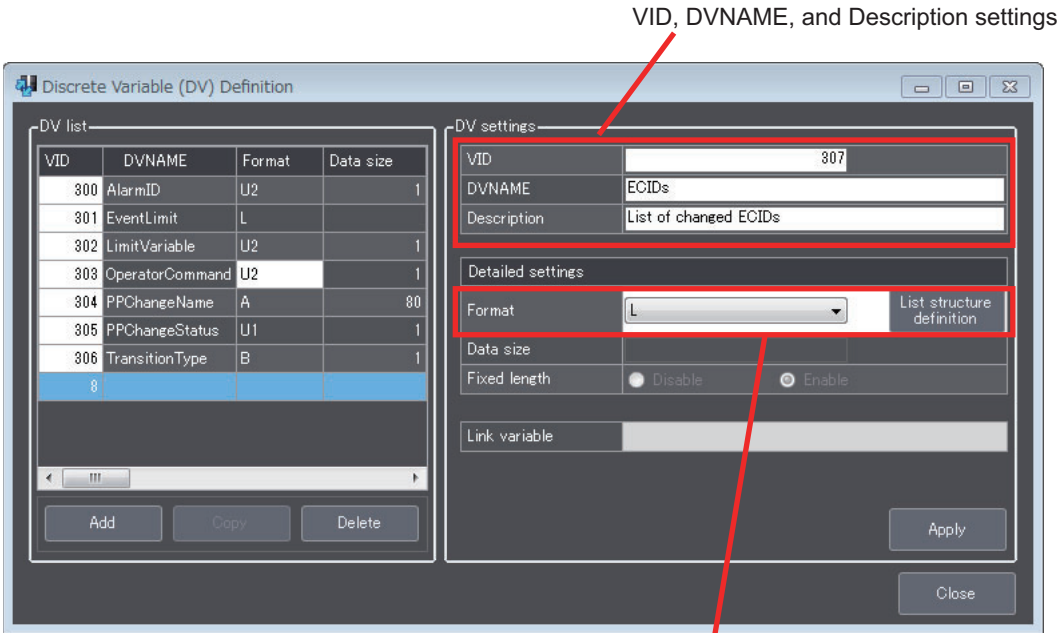

Set the format to L and set the list structure.

Set the format to L and set the list structure. The settings for the list structure are shown below.

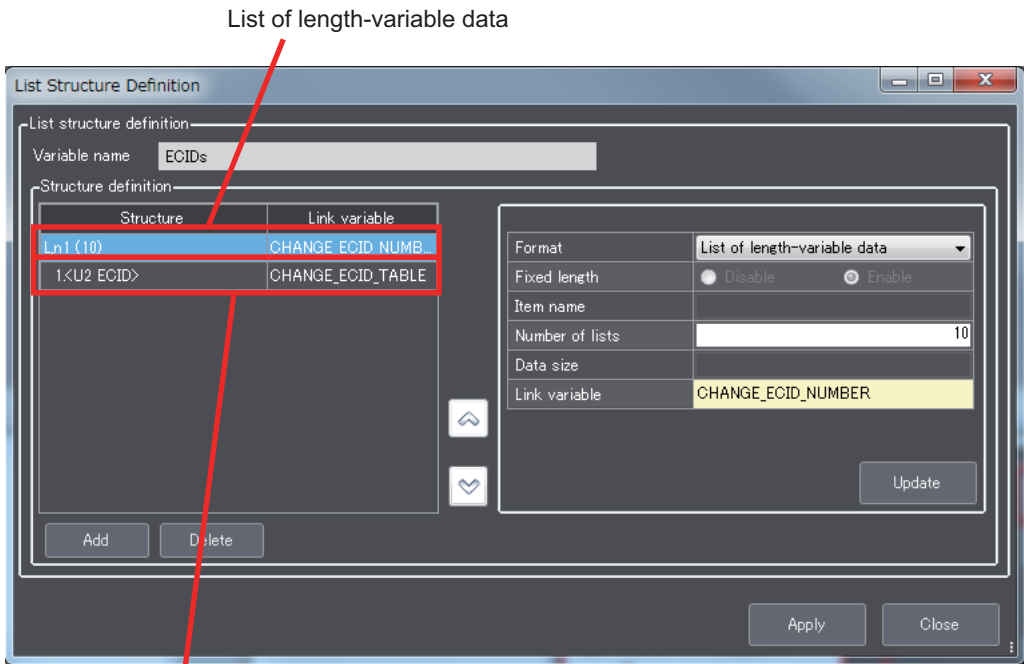

Item

The list of length-variable data and item to set are given in the following table.

Type	Item name	Number of lists	Data size	Link variable
List of length-variable data	---	10	---	CHANGE_ECID_NUMBER
Item	ECID	---	1	CHANGE_ECID_TABLE

### ● Report Definition Settings

The report definition in the structure of the Operator Equipment Constant Change message is set. The specifications of the defined report are given in the following table.

RPTID	Report name	Linked VID
11	Equipment Constant Changed Report	307

The following procedure is used for the settings on the Report Definition Tab Page accessed from **GEM capability – Event Notification** in the List Menus.

- 1** Add RPTID 11 (Equipment Constant Changed Report) to the report list.
- 2** Enter the PRTID and report name in the report definition.
- 3** In the variable list, select VID 307 (*ECIDs*).
- 4** Move *ECIDs* to the structure.
- 5** Click the **Apply** Button.

The Report Definition Tab Page appears as shown below.

- 2. Enter the RPTID and report name.
- 4. Move *ECIDs* to the structure.

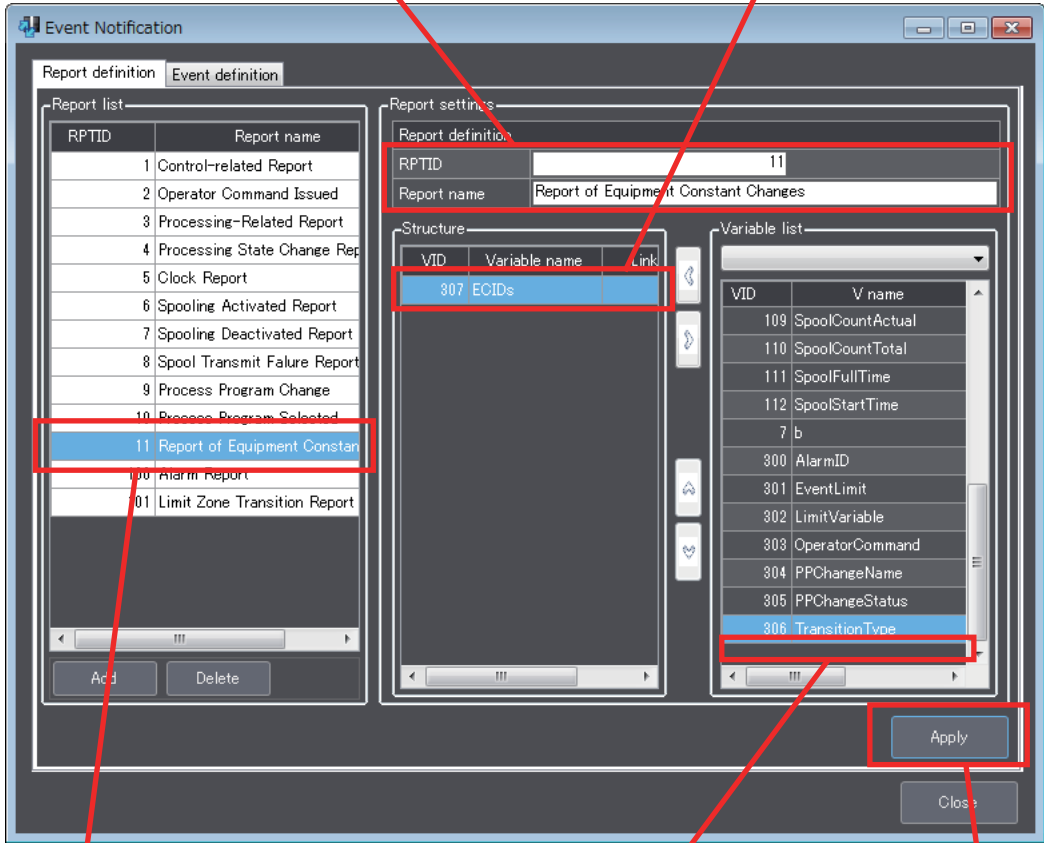

1. Add RPTID 11 (Equipment Constant Changed Report) to the report list.

3. In the variable list, select VID 307 (*ECIDs*).

5. Click the **Apply** Button.

## ● Event Definition Settings

The event definition in the structure of the Operator Equipment Constant Change message is set. The specifications of the defined event are given in the following table.

CEID	Event name	Linked RPTID
9	Operator Equipment Constant Change	11

The following procedure is used for the settings on the Event Definition Tab Page accessed from **GEM capability – Event Notification** in the List Menus.

- 1** Select CEID 9 (Operator Equipment Constant Change) to the event list.
- 2** Select RPTID 11 (Equipment Constant Changed Report) in the report name list.
- 3** Move the Equipment Constant Change Report to the event structure.
- 4** Click the **Apply** Button.

The Event Definition Tab Page appears as shown below.

- 3.** Move the Equipment Constant Change Report to the structure.

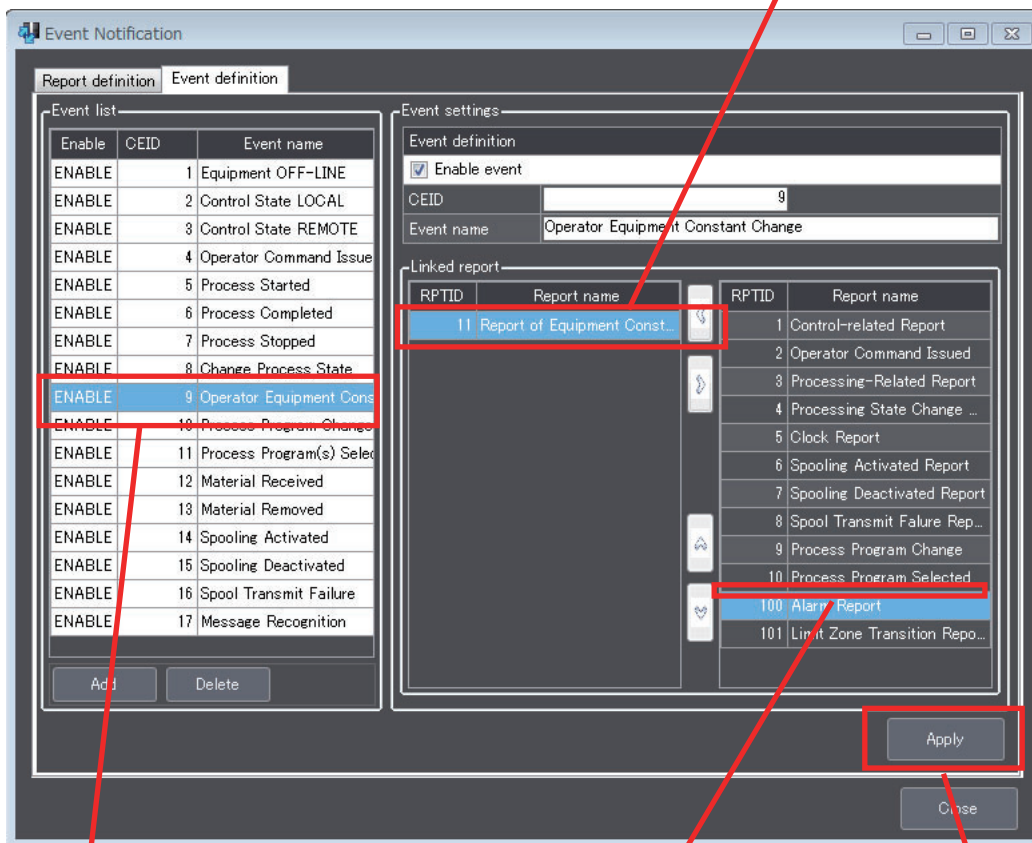

- 1.** Select CEID 9 (Operator Equipment Constant Change) to the event list.
- 2.** Select RPTID 11 (Equipment Constant Changed Report) in the report name list.
- 4.** Click the **Apply** Button.

## 8-11-2 Alarm Management

The **Alarm Management** command is used to set alarm operation and define alarms. Refer to 5-5-11 *Alarm Management* on page 5-53 for details on alarm management.

The Alarm Management Dialog Box has an Operation Settings Tab Page to define alarm operation and an Alarm Definition Tab Page to define alarms.

### Operation Settings Tab Page

The Operation Settings Tab Page is used to set the CEID offset when alarms occur and the CEID offset when alarms are cleared for alarm management.

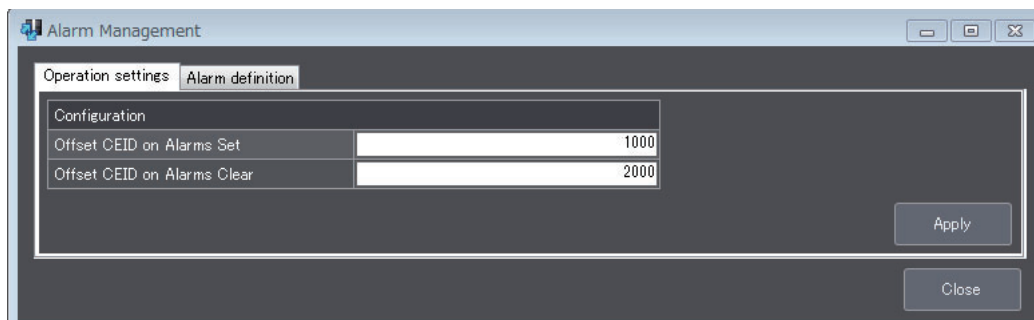

The items that are displayed on the Operation Settings Tab Page are described in the following table along with the meanings and value ranges of the items.

Item	Meaning	Range of values
Configuration		
Offset CEID on Alarms Set	The CEID offset of the collection events that are issued when alarms occur.	Depends on the format that is set for the CEID in the item definitions.
Offset CEID on Alarms Clear	The CEID offset of the collection events that are issued when alarms are cleared.	Depends on the format that is set for the CEID in the item definitions.

The error messages that may be displayed on this tab page are described in the following table.

Error message	Cause	Correction
An entry is empty.	As given in the error message.	Set all of the items.
The entered value is out of the specified range. [Range: xxxx to yyyy]	As given in the error message.	Set a value within the valid setting range.
The CEID on Alarms Set is duplicated.	The value of a CEID when an alarm occurs is used by another collection event.	Change the values of the CEIDs when alarms occur.
The CEID on Alarms Clear is duplicated.	The value of a CEID when an alarm is cleared is used by another collection event.	Change the values of the CEIDs when alarms are cleared.

## Alarm Definition Tab Page

The Alarm Definition Tab Page is used to edit, add, and delete alarm definitions.

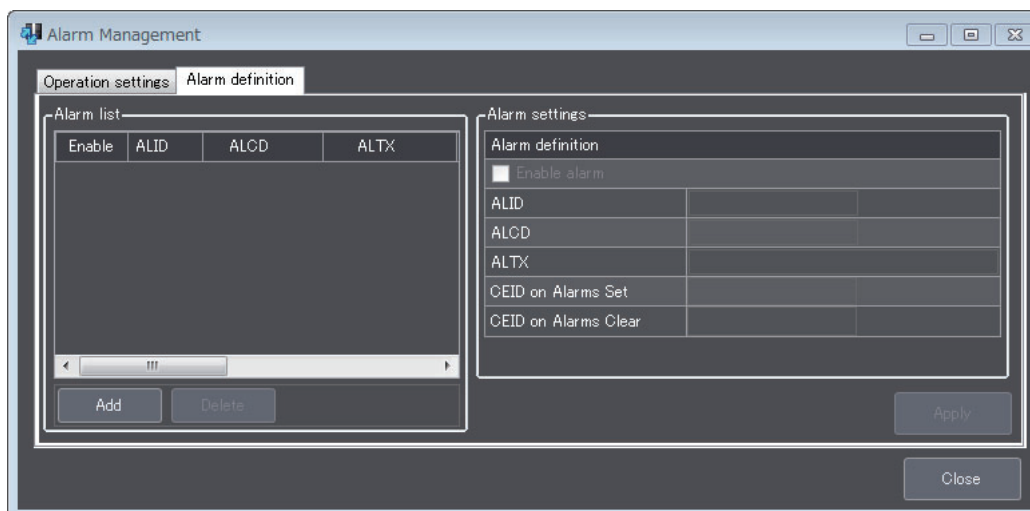

The alarm settings that are displayed on the Alarm Definition Tab Page are described in the following table along with the meanings and value ranges of the settings.

Item	Meaning	Range of values
Alarm definition		
Enable alarm	Whether to enable the selected alarm.	Enable/disable
ALID	ALID	Depends on the format that is set for the ALID in the item definitions. You cannot set the ALID to 0.
ALCD	ALCD	0-63
ALTX	ALTX	Alphanumerics The maximum data size is the data size specified for the ALTX in the item definitions.
CEID on Alarms Set	The CEID of the collection event that is issued when the alarm occurs.	This value cannot be changed.
CEID on Alarms Clear	The CEID of the collection event that is issued when the alarm is cleared.	This value cannot be changed.



The error messages that may be displayed on this tab page are described in the following table.

Error message	Cause	Correction
An entry is empty.	As given in the error message.	Set all of the items.
The entered value is out of the specified range. [Range: xxxx to yyyy]	As given in the error message.	Set a value within the valid setting range.
An ALID is duplicated.	As given in the error message.	Change the value of the ALID.
The CEID <sub>n</sub> on Alarms Set is duplicated.	As given in the error message.	Change the value of CEID <sub>n</sub> when the alarm occurs.
The CEID <sub>n</sub> on Alarms Clear is duplicated.	As given in the error message.	Change the value of CEID <sub>n</sub> when the alarm is cleared.
The CEID on Alarms Set is out of range. [Range: xxxx to yyyy]	As given in the error message.	Change the value of the CEID when the alarm occurs. If you change the format of CEID on Alarms Set, change the item definition.
The CEID on Alarms Clear is out of range. [Range: xxxx to yyyy]	As given in the error message.	Change the value of the CEID when the alarm is cleared. If you change the format of CEID on Alarms Clear, change the item definition.
The ALTX exceeds the maximum number of characters that can be entered. [Maximum: 128]	As given in the error message.	Specify the ALTX with 128 characters or less.

### 8-11-3 Host Command

The **Host Command** command on the Remote Control Menu is used to define host command operation and to define host commands.

Refer to 5-5-12 *Host Commands* on page 5-56 for details on host commands. The Host Command Dialog Box has an Operation Settings Tab Page to define host command operation and a Host Command Definition Tab Page to define host commands.

#### Operation Settings Tab Page

The Operation Settings Tab Page is used to set the operation conditions for host commands, such as the attributes and the variables to which to pass item information.

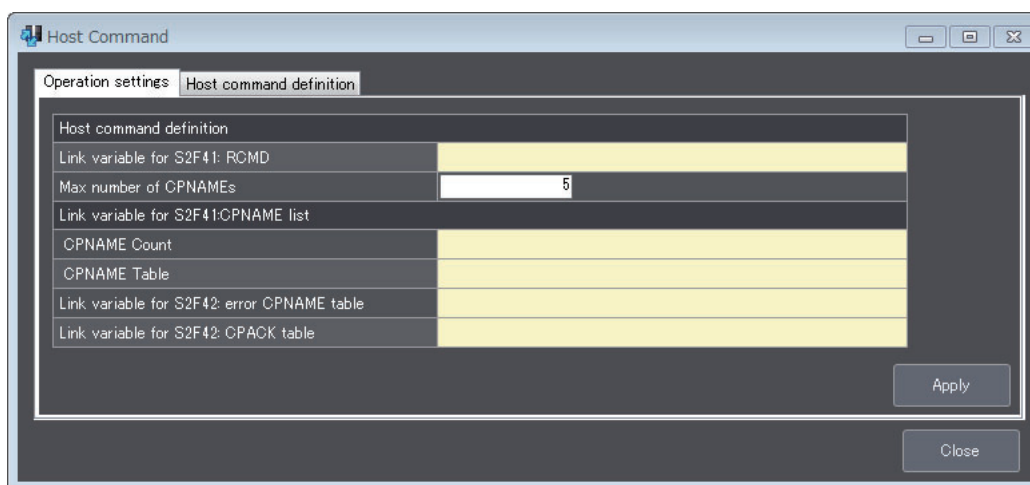

The items that are displayed on the Operation Settings Tab Page are described in the following table along with the meanings and value ranges of the items.

Item	Meaning	Range of values
Host command definition		
Link variable for S2F41: RCMD	A link variable to store the value of RCMD.*1	---
Max number of CPNAMEs	The maximum number of CPNAMEs that can be received. The CPNAME count with the highest number of CPNAMEs of all the host commands.	0-32
Link variable for S2F41: CPNAME list	A variable to store number of received CPNAMEs. There are the following two variables. <ul style="list-style-type: none"> <li>• CPNAME Count*2</li> <li>• CPNAME Table*3</li> </ul>	---
Link variable for S2F42: error CPNAME table	A variable to store the values of CPNAMEs with CPVAL errors.*3	---
Link variable for S2F42: CPACK table	A variable to store the values of CPACKs with CPVAL errors*4	---

\*1. A host command cannot be used if link variables are not specified.

\*2. The data type is UINT.

\*3. It is an array variable. The array element data type must agree with the format of the CPNAMEs. The number of array elements exceeds the maximum number of CPNAMEs.

\*4. It is an array variable. The array element data type must agree with the format of the CPACKs. The number of array elements exceeds the maximum number of CPNAMEs.

The error messages that may be displayed on this tab page are described in the following table.

Error message	Cause	Correction
An entry is empty.	As given in the error message.	Set all of the items.
The entered value is out of the specified range. [Range: xxxx to yyyy]	As given in the error message.	Set a value within the valid setting range.
The specified maximum number of CPNAMEs is smaller than the number of already registered CPNAMEs.	As given in the error message.	Change the value of the maximum number of CPNAMEs. Or, delete registered CPNAMEs.
A link variable is not specified	As given in the error message.	Specify a link variable.

## Host Command Definition Tab Page

The Host Command Definition Tab Page is used to edit, add, and delete host command definitions.

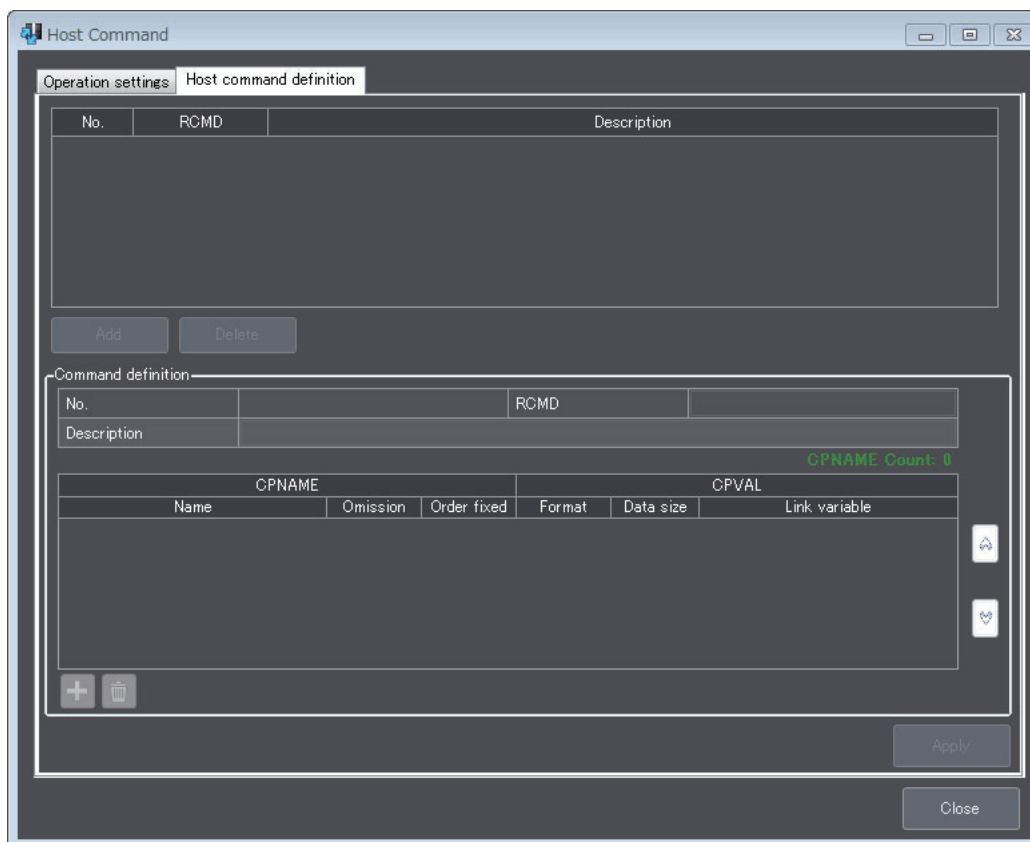

The command definition items that are displayed on the Host Command Definition Tab Page are described in the following table along with the meanings and value ranges of the items.

Item	Meaning	Range of values
RCMD	RCMD	Alphanumerics The maximum value is the data size set for RCMD in the item definitions.
Description	A description of the operation of the host command.	Single-byte characters: 128 characters max. Double-byte characters: 64 characters max.
CPNAME		
Name	CPNAME	Alphanumerics The maximum value is the data size set for CPNAME in the item definitions.
Omission	Specifies whether Host Command Send (S2,F41) is to be accepted if a CPNAME is not specified.	Selected: Accepted. Not selected: Not accepted.
Order fixed	Specifies whether Host Command Send (S2,F41) is to be accepted if the CPNAMEs are not in the registered reception order.	Selected: Accepted. Not selected: Not accepted.
CPVAL		
Format	The format of CPVAL.	B, BOOLEAN, A, I1, I2, I4, U1, U2, or U4
Data size	The data size of CPVAL.	When format of CPVAL is B or A: 1 to 120 Other formats: 1
Link variable	A link variable to store the value of CPVAL.	---

The error messages that may be displayed on this tab page are described in the following table.

<b>Error message</b>	<b>Cause</b>	<b>Correction</b>
An entry is empty.	As given in the error message.	Set all of the items.
The entered value is out of the specified range. [Range: xxxx to yyyy]	As given in the error message.	Set a value within the valid setting range.
The reception order cannot be set to fix for the CPNAME which is set to omit and for the subsequent CPNAMEs.	As given in the error message.	Set all CPNAMEs after any CPNAME that is set to allow omission, so that the CPNAME order is not fixed.
An RCMD is duplicated.	As given in the error message.	Change the value of the RCMD.
A CPNAME is duplicated.	The value of the CPNAME is used for another host command.	Change the value of the CPNAME.
A link variable is not specified	As given in the error message.	Specify the variable to link.
An entry may be over the valid input range. [Valid input range: xx characters or less]	The number of characters entered for RCMD or CPNAME exceeds the maximum number of characters.	Change the number of characters in the RCMD or CPNAME.

## 8-11-4 Enhanced Remote Command

The **Enhanced Remote Command** command on the Remote Control Menu is used to define enhanced remote command operation and to define enhanced remote commands. Refer to 5-5-13 *Enhanced Remote Commands* on page 5-60 for details on enhanced remote commands.

The Enhanced Remote Command Dialog Box has an Operation Settings Tab Page to define enhanced remote command operation and an Enhanced Remote Command Definition Tab Page to define enhanced remote commands.

### Operation Settings Tab Page

The Operation Settings Tab Page is used to set the operation conditions for enhanced remote commands, such as the attributes and the variables to which to pass item information.

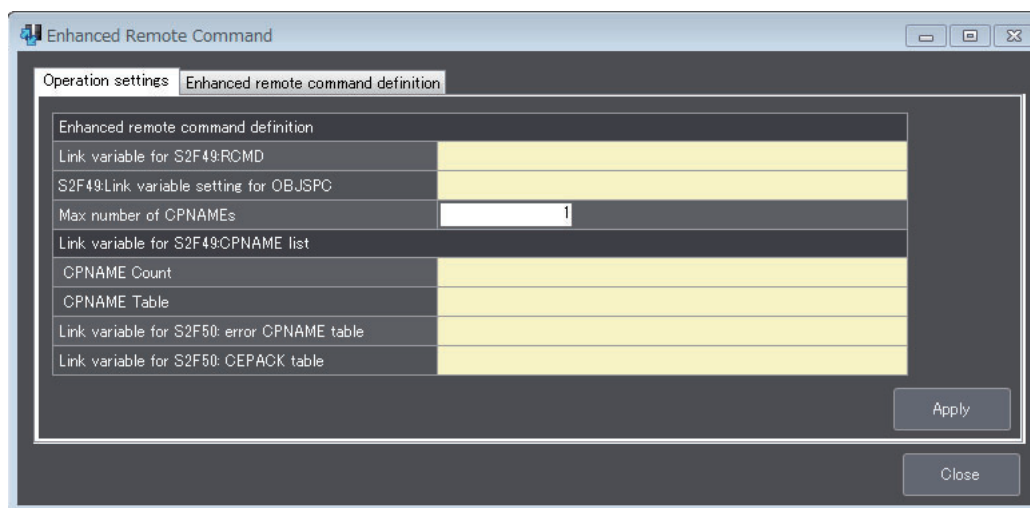

The items that are displayed on the Operation Settings Tab Page are described in the following table along with the meanings and value ranges of the items.

Item	Meaning	Range of values
Enhanced remote command definition		
Link variable for S2F49: RCMD	A link variable to store the value of RCMD.*1	---
Link variable for S2F49: OBJSPEC	A link variable to store the value of OBJSPEC.	---
Max number of CPNAMEs	The maximum number of CPNAMEs that can be received. The CPNAME count with the highest number of CPNAMEs of all the enhanced remote commands.	0-32
Link variable for S2F49: CPNAME list	A link variable to store the number of received CPNAMEs. There are the following two variables. <ul style="list-style-type: none"> <li>• CPNAME Count*2</li> <li>• CPNAME Table*3</li> </ul>	---
Link variable for S2F50: error CPNAME table	A link variable to store the values of CPNAMEs with CEPVAL errors.*3	---
Link variable for S2F50: CEPACK table	A link variable to store the values of CEPACKs with CEPVAL errors.*4	---

\*1. An enhanced remote command cannot be used if the link variables are not specified.

\*2. The data type is UINT.

- \*3. It is an array variable. The array element data type must agree with the format of the CPNAMEs. The number of array elements exceeds the maximum number of CPNAMEs.
- \*4. It is an array variable. The array element data type must agree with the format of the CEPACKs. The number of array elements exceeds the maximum number of CPNAMEs.

The error messages that may be displayed on this tab page are described in the following table.

Error message	Cause	Correction
An entry is empty.	As given in the error message.	Set all of the items.
The entered value is out of the specified range. [Range: xxxx to yyyy]	As given in the error message.	Set a value within the valid setting range.
The specified maximum number of CPNAMEs is smaller than the number of already registered CPNAMEs.	As given in the error message.	Change the value of the maximum number of CPNAMEs. Or, delete registered CPNAMEs.
A link variable is not specified	As given in the error message.	Specify the variable to link.

## Enhanced Remote Command Definition Tab Page

The Enhanced Remote Command Definition Tab Page is used to edit, add, and delete enhanced remote command definitions.

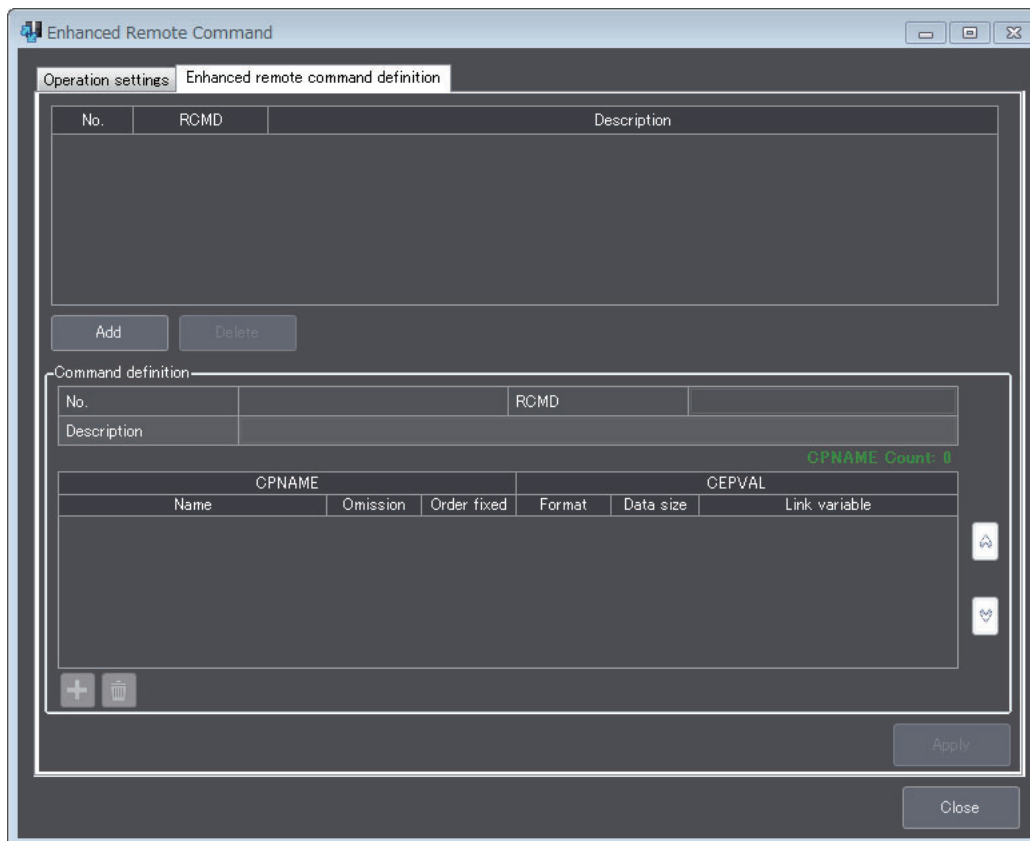

The command definition items that are displayed on the Enhanced Remote Command Definition Tab Page are described in the following table along with the meanings and value ranges of the items.

Item	Meaning	Range of values
RCMD	RCMD	Alphanumerics The maximum value is the data size set for RCMD in the item definitions.
Description	A description of the operation of the enhanced remote command.	Single-byte characters: 128 characters max. Double-byte characters: 64 characters max.
CPNAME		
Name	CPNAME	Alphanumerics The maximum value is the data size set for CPNAME in the item definitions.
Omission	Specifies whether Enhanced Remote Command (S2,F49) is to be accepted if a CPNAME is not specified.	Selected: Accepted. Not selected: Not accepted.
Order fixed	Specifies whether Enhanced Remote Command (S2,F49) is to be accepted if the CPNAMEs are not in the registered reception order.	Selected: Accepted. Not selected: Not accepted.
CEPVAL		
Format	The format of CEPVAL.	B, BOOLEAN, A, I1, I2, I4, F4, F8, U1, U2, or U4
Data size	The data size of CEPVAL.	Depends on the format of CEPVAL.
Link variable	A link variable to store the value of CEPVAL.	---



The error messages that may be displayed on this tab page are described in the following table.

Error message	Cause	Correction
An entry is empty.	As given in the error message.	Set all of the items.
The entered value is out of the specified range. [Range: xxxx to yyyy]	As given in the error message.	Set a value within the valid setting range.
The reception order cannot be set to fix for the CPNAME which is set to omit and for the subsequent CPNAMEs.	As given in the error message.	Set all CPNAMEs after any CPNAME that is set to allow omission, so that the CPNAME order is not fixed.
An RCMD is duplicated.	As given in the error message.	Change the value of the RCMD.
A CPNAME is duplicated.	The value of the CPNAME is used for another enhanced remote command.	Change the value of the CPNAME.
A link variable is not specified	As given in the error message.	Specify the variable to link.
An entry may be over the valid input range. [Valid input range: xx characters or less]	The number of characters entered for RCMD or CPNAME exceeds the maximum number of characters.	Change the number of characters in the RCMD or CPNAME.

### 8-11-5 Equipment Constants

The **Equipment Constants** command is used to set the variables to which to pass ECID lists when there are change requests for them from the host.

Refer to 5-5-14 *Equipment Constants* on page 5-62 for details on equipment constants.

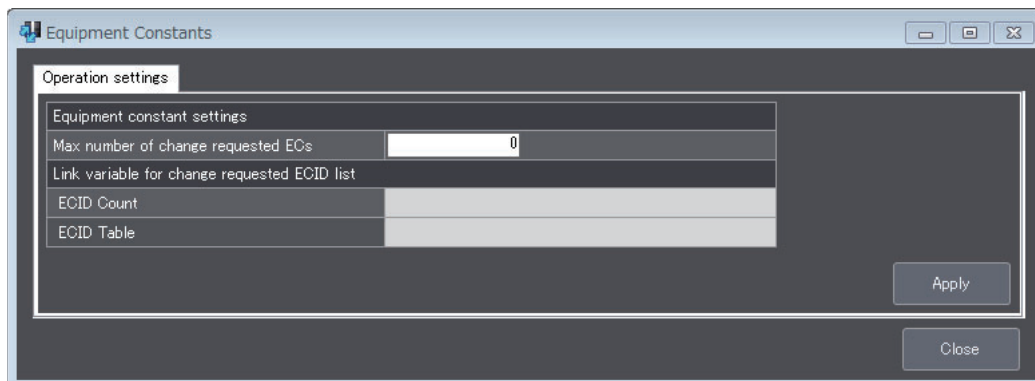

The items that are displayed in the Equipment Constants Dialog Box are described in the following table along with the meanings and value ranges of the items.

Item	Meaning	Range of values
Equipment constant settings		
Max number of change requested ECs	The maximum number of ECIDs that can be specified with New Equipment Constant Send (S2,F15).	0-100*1
Link variable for change requested ECID list	A link variable to report the ECID list specified with New Equipment Constant Send (S2,F15). There are the following two variables. <ul style="list-style-type: none"> <li>• ECID Count*2</li> <li>• ECID Table*3</li> </ul>	---

\*1. You cannot use the equipment constant if you specify 0.

\*2. The data type is UINT.

\*3. It is an array variable. The array element data type must agree with the format of the ECIDs. The number of array elements exceeds the maximum number of change requested ECs.

The error messages that may be displayed for this menu command are described in the following table.

Error message	Cause	Correction
An entry is empty.	As given in the error message.	Set all of the items.
The entered value is out of the specified range. [Range: xxxx to yyyy]	As given in the error message.	Set a value within the valid setting range.
A link variable is not specified	As given in the error message.	Specify the variable to link.

## 8-11-6 Process Program Management

The **Process Program Management** command is used to define the operation of unformatted process programs and formatted process programs.

Refer to *5-5-15 Process Program Management* on page 5-66 for details on process program management.

The Process Program Management Dialog Box has the following four tab pages.

- Operation Settings Tab Page  
This tab page is used to define the common operation of the unformatted process programs and formatted process programs.
- Unformatted Tab Page  
Used to define unformatted process programs.
- Formatted (1)  
Used to define the CCODE/PPARM structure for formatted process programs.
- Formatted (2)  
Used to define the link variables for formatted process programs.

## Operation Settings Tab Page

The Operation Settings Tab Page is used to set the number of saved process programs and the operation conditions of the process program management table.

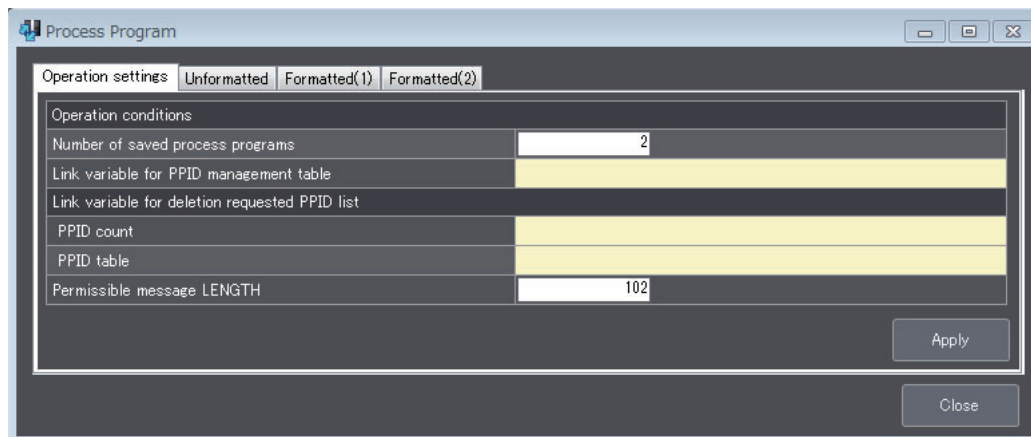

The items that are displayed on the Operation Settings Tab Page are described in the following table along with the meanings and value ranges of the items.

Item	Meaning	Range of values
Operation conditions		
Number of saved process programs	The maximum number of unformatted process programs and formatted process programs to save.	0-40 <sup>*1</sup>
Link variable for PPID management table	A link variable for the PPID management table.	---
Link variable for deletion requested PPID list	A link variable for the PPID list of deletion requests from the host. There are the following two variables. <ul style="list-style-type: none"> <li>• PPID Count<sup>*2</sup></li> <li>• PPID Table<sup>*3</sup></li> </ul>	---
Permissible message LENGTH	The maximum data size in Kbytes without the header for Process Program Send (S7,F3) and Formatted Process Program Send (S7,F23). <sup>*4</sup>	1-257

\*1. You cannot use process program management if you specify 0.

\*2. The data type is UINT.

\*3. It is an array variable. The array element data type must agree with the format of the PPIDs. The number of array elements must be equal to or greater than the number of unformatted process programs and formatted process programs to save.

\*4. If both Process Program Send (S7,F3) and Formatted Process Program Send (S7,F23) are used, set the larger maximum data size.

The error messages that may be displayed on this tab page are described in the following table.

Error message	Cause	Correction
An entry is empty.	As given in the error message.	Set all of the items.
The entered value is out of the specified range. [Range: xxxx to yyyy]	As given in the error message.	Set a value within the valid setting range.
A link variable is not specified	As given in the error message.	Specify the variable to link.

## Unformatted Tab Page

The Unformatted Tab Page is used to define unformatted process programs and to set the variables to which to pass the data.

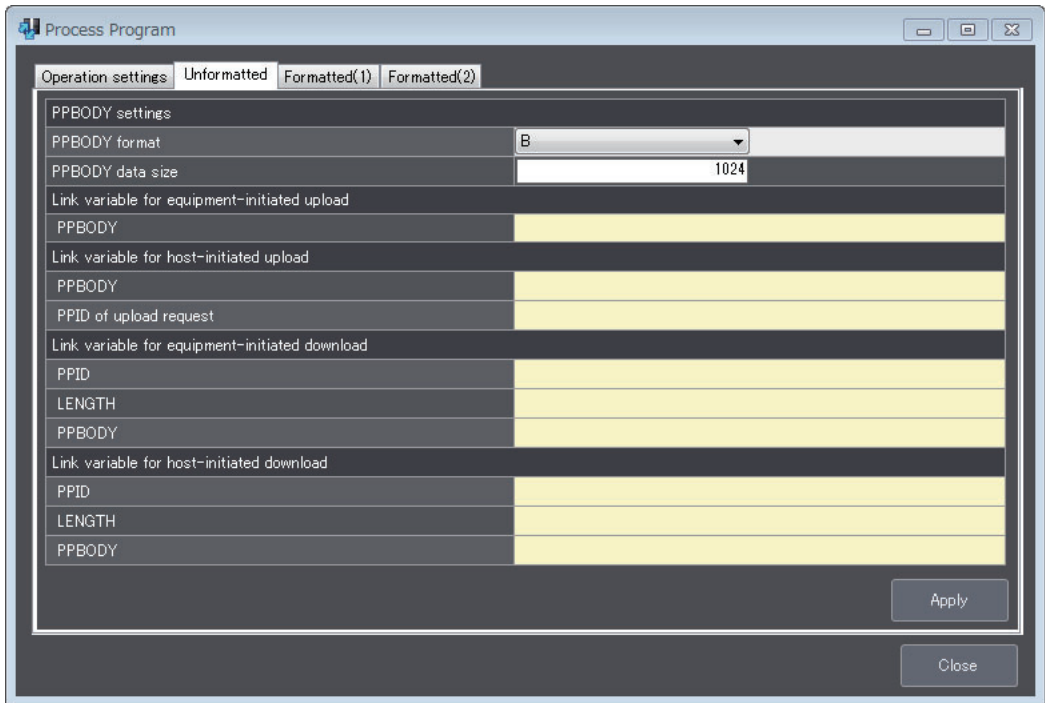

The items that are displayed on the Unformatted Tab Page are described in the following table along with the meanings and value ranges of the items. You cannot use unformatted process programs if you do not set all of the link variables on the Unformatted Tab Page.

Item	Meaning	Range of values
PPBODY settings		
PPBODY format	The format of PPBODY.	B, A, I1, I2, I4, U1, U2, or U4
PPBODY data size	The data size in bytes of PPBODY. For format A or B, specify the data length. For formats other than A and B, specify the number of elements.	Depends on the format.
Link variable for equipment-initiated upload	A link variable for an unformatted process program from an equipment-initiated upload. There is the following one variable. • PPBODY	---
Link variable for host-initiated upload	A link variable for an unformatted process program from a host-initiated upload. There are the following two variables. • PPBODY • PPID of upload request	---
Link variable for equipment-initiated download	A link variable for an unformatted process program from an equipment-initiated download. There are the following three variables. • PPID* <sup>1</sup> • LENGTH* <sup>2</sup> • PPBODY* <sup>3</sup>	---
Link variable for host-initiated download	A link variable for an unformatted process program from a host-initiated download. There are the following three variables. • PPID* <sup>1</sup> • LENGTH* <sup>2</sup> • PPBODY* <sup>3</sup>	---

\*1. The data type must agree with the format of the PPIDs.

\*2. The data type must agree with the format of the LENGTH.

\*3. The data type must agree with the format of the PPBODY.

The error messages that may be displayed on this tab page are described in the following table.

Error message	Cause	Correction
An entry is empty.	As given in the error message.	Set all of the items.
The entered value is out of the specified range. [Range: xxxx to yyyy]	As given in the error message.	Set a value within the valid setting range.
A link variable is not specified	As given in the error message.	Specify the variable to link.

## Formatted (1) Tab Page

The Formatted (1) Tab Page is used to edit, add, and delete CCODE/PPARM definitions for formatted process programs.

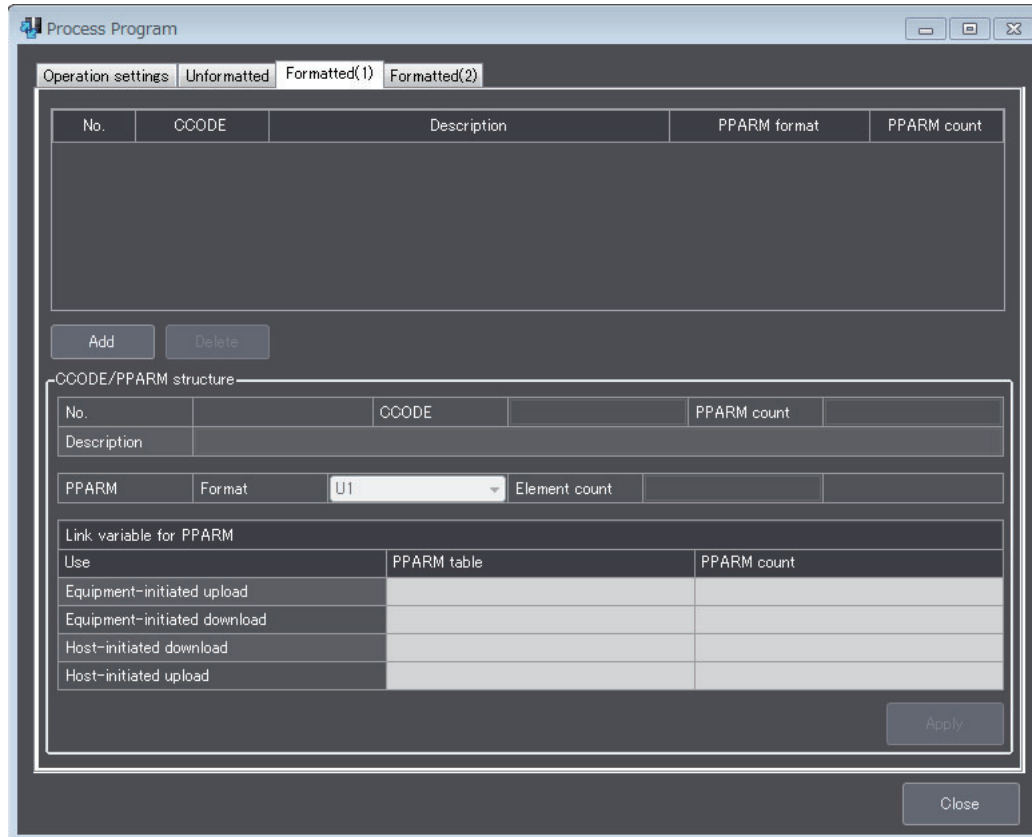

The CCODE/PPARM definition items that are displayed on the Formatted (1) Tab Page are described in the following table along with the meanings and value ranges of the items.

Item	Meaning	Range of values
CCODE	CCODE* <sup>1</sup>	A, I2, I4, U2, or U4 50 max.
PPARM count	The maximum number of linked PPARMs for each CCODE.	1-20
Description	A description of the command code.	Single-byte characters: 128 characters max. Double-byte characters: 64 characters max.
PPARM		
Format	The PPARM format for each CCODE.	BOOLEAN, A, I1, I2, I4, F4, F8, U1, U2, or U4
Data size	The data size in bytes of PPARM. For format A or B, specify the data length. For formats other than A and B, specify the number of elements.	Format A: 1 to 120 bytes Formats other than A: 1 to 32 items

\*1. You cannot use formatted process programs if the CCODEs are not registered.

The error messages that may be displayed on this tab page are described in the following table.

<b>Error message</b>	<b>Cause</b>	<b>Correction</b>
An entry is empty.	As given in the error message.	Set all of the items.
The entered value is out of the specified range. [Range: xxxx to yyyy]	As given in the error message.	Set a value within the valid setting range.
A CCODE is duplicated.	The value of CCODE is used in another unformatted process program or formatted process program.	Change the value of the CCODE.
A link variable is not specified	As given in the error message.	Specify the variable to link.
An entry may be over the valid input range. [Valid input range: xx characters or less]	As given in the error message.	Change the number of entered characters.
A message in the process program exceeds the permissible message LENGTH.	As given in the error message.	Change the format definition or permissible message length.



## Formatted (2) Tab Page

The Formatted (2) Tab Page is used to set the variables to which to pass the data for formatted process programs.

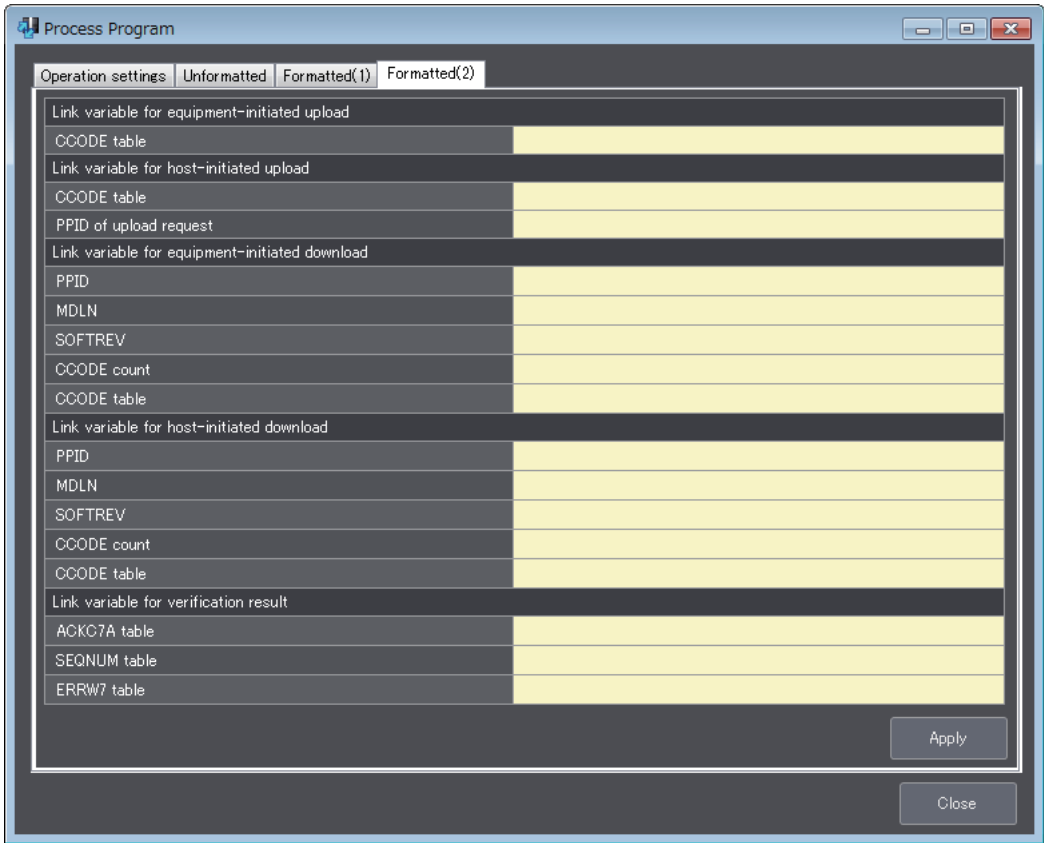

The items that are displayed on the Formatted (2) Settings Tab Page are described in the following table along with the meanings and value ranges of the items.

Item	Meaning	Range of values
Link variable for equipment-initiated upload	A link variable for a formatted process program from an equipment-initiated upload. There is the following one variable. • CCODE table <sup>*1</sup>	---
Link variable for host-initiated upload	A link variable for a formatted process program from a host-initiated upload. There are the following two variables. • CCODE table <sup>*1</sup> • PPID of upload request	---
Link variable for equipment-initiated download	A link variable for a formatted process program from an equipment-initiated download. There is the following one variable. • PPID <sup>*2</sup> • MDLN <sup>*3</sup> • SOFTREV <sup>*4</sup> • CCODE count • CCODE table <sup>*1</sup>	---
Link variable for host-initiated download	A link variable for an formatted process program from a host-initiated download. There are the following five variables. • PPID <sup>*2</sup> • MDLN <sup>*3</sup> • SOFTREV <sup>*4</sup> • CCODE count • CCODE table <sup>*1</sup>	---
Link variable for verification check result	A link variable for the detected error information for a downloaded formatted process program. <sup>*5</sup> There are the following three variables. • ACKC7A table <sup>*6</sup> • SEQNUM table <sup>*7</sup> • ERRW7 table <sup>*8</sup>	---

\*1. It is an array variable. The array element data type must agree with the format of the CCODE. The number of array elements exceeds the registered CCODE count.

\*2. The data type must agree with the format of the PPID.

\*3. The data type must agree with the format of the MDLN.

\*4. The data type must agree with the format of the SOFTREV.

\*5. This setting is made for verification.

\*6. It is an array variable. The array element data type must agree with the format of the ACKC7A. The number of array elements exceeds the registered CCODE count.

\*7. It is an array variable. The array element data type must agree with the format of the SEQNUM. The number of array elements exceeds the registered CCODE count.

\*8. It is an array variable. The array element data type must agree with the format of the ERRW7. The number of array elements exceeds the registered CCODE count.

The error messages that may be displayed on this tab page are described in the following table.

Error message	Cause	Correction
There is a link variable that is not set.	As given in the error message.	Set variable names for all of the link variables.
A link variable is not specified	As given in the error message.	Specify a link variable.

## 8-11-7 Equipment Terminal Service

The **Equipment Terminal Service** command is used to set the maximum number of TEXTs and the additional terminal TIDs for the terminal service.

Refer to 5-5-17 *Equipment Terminal Service* on page 5-88 for details on the equipment terminal service.

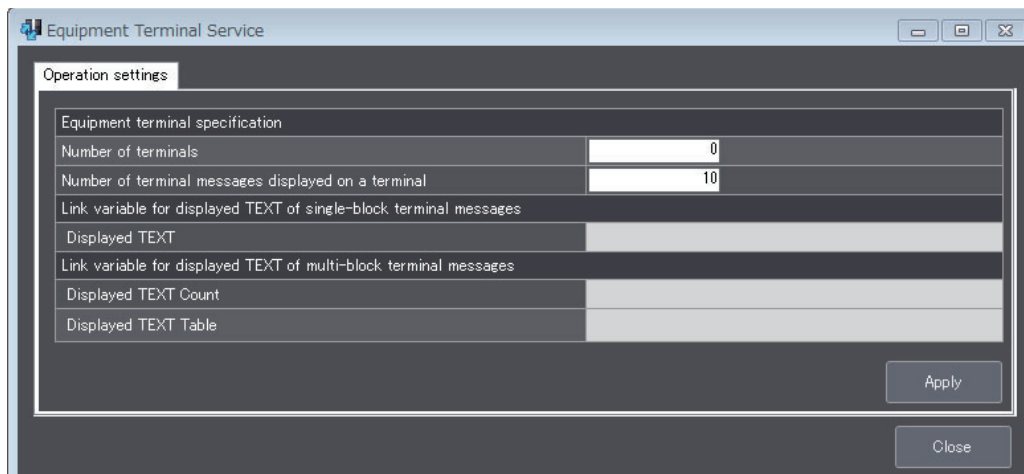

The items that are displayed in the Equipment Terminal Service Dialog Box are described in the following table along with the meanings and value ranges of the items.

Item	Meaning	Range of values
Equipment terminal specification		
Number of terminals	The number of terminals in the equipment. 1: Main terminal (TID = 0) 2: Main terminal (TID = 0) and additional terminal (TID = 1)	0-2 <sup>*1</sup>
Number of terminal messages displayed on a terminal	The number of message lines displayed on the terminal. The maximum number of TEXTs that can be received for Terminal Display, Multi-block (S10,F5).	0-20 <sup>*2</sup>
Link variable for displayed TEXT of single-block terminal messages	A link variable for the value of TEXT for which display was requested with Terminal Display, Single (S10,F3). <sup>*3</sup> There is the following one variable. • Displayed TEXT	---
Link variable for displayed TEXT of multi-block terminal messages	A link variable for the value of TEXT for which display was requested with Terminal Display, Multi-block (S10,F5). There are the following two variables. • Displayed TEXT Count <sup>*4</sup> • Displayed TEXT Table <sup>*5</sup>	---

\*1. You cannot use the equipment terminal display if you specify 0.

\*2. You cannot use multi-block equipment terminal messages if you specify 0.

\*3. The data type is STRING with the number of characters set in the TEXT item.

\*4. The data type is UINT.

\*5. It is an array variable. The array element data type is STRING with the number of characters set in the TEXT item. The number of array elements must be equal to or greater than the number of displayed terminal messages.

The error messages that may be displayed for this menu command are described in the following table.

Error message	Cause	Correction
An entry is empty.	As given in the error message.	Set all of the items.
The entered value is out of the specified range. [Range: xxxx to yyyy]	As given in the error message.	Set a value within the valid setting range.
A link variable is not specified	As given in the error message.	Specify a link variable.

## 8-11-8 Limit Monitoring

The **Limit Monitoring** command is used to set the operation conditions for limit monitoring. Refer to 5-5-19 *Limit Monitoring* on page 5-93 for details on limit monitoring.

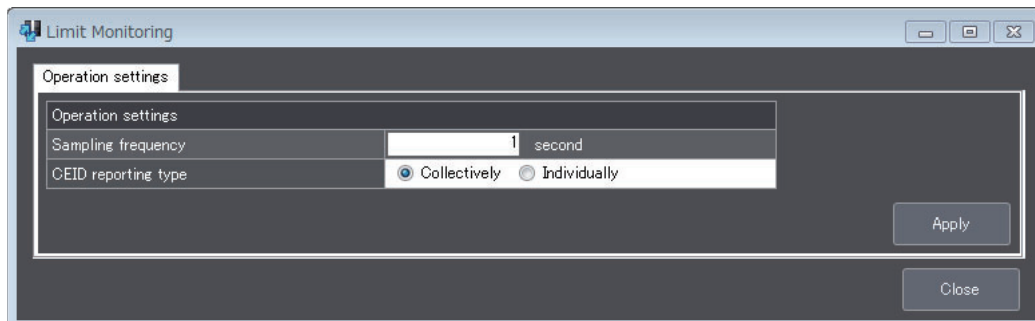

The items that are displayed in the Limit Monitoring Dialog Box are described in the following table along with the meanings and value ranges of the items.

Item	Meaning	Range of values
Operation settings		
Sampling frequency	The sampling period in seconds for limit monitoring.	1-360
CEID reporting type	The collection event reporting method when more than one zone transition occurs in the same sampling period.	Collectively or Individually

The error messages that may be displayed for this menu command are described in the following table.

Error message	Cause	Correction
An entry is empty.	As given in the error message.	Set all of the items.
The entered value is out of the specified range. [Range: xxxx to yyyy]	As given in the error message.	Set a value within the valid setting range.

### 8-11-9 Spooling

The **Spooling** command is used to set operation conditions for spooling, such as the number of spooled messages.

Refer to 5-5-20 *Spooling* on page 5-96 for details on spooling.

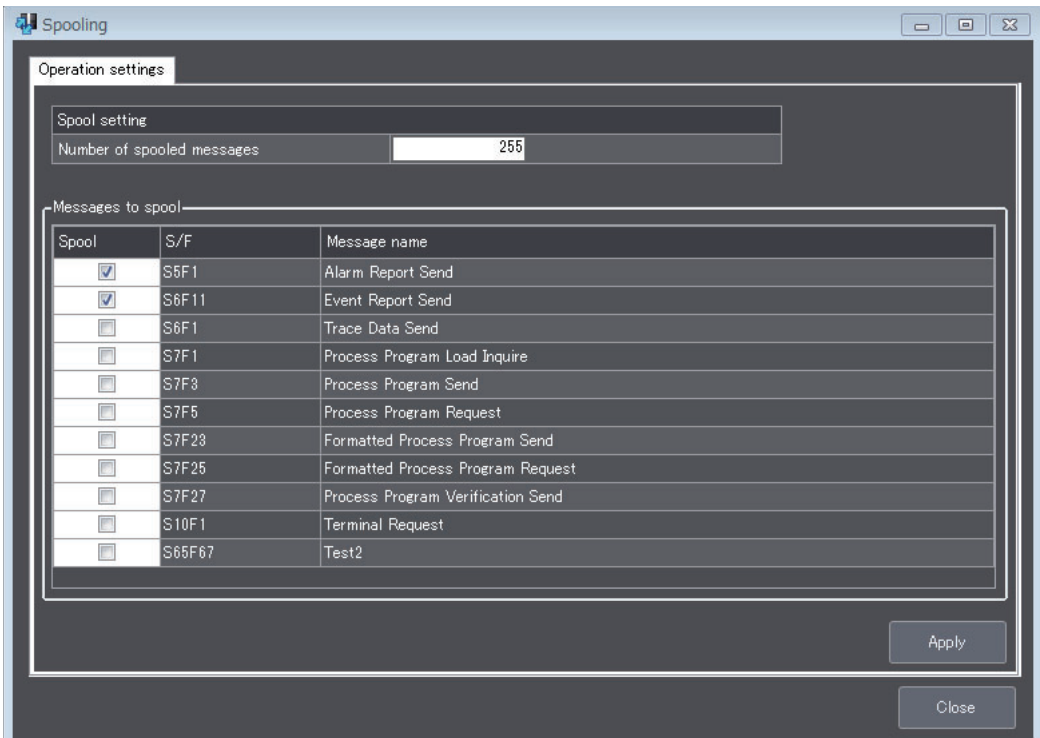

The items that are displayed in the Spooling Dialog Box are described in the following table along with the meanings and value ranges of the items.

Item	Meaning	Range of values
Spool setting		
Number of spooled messages	The maximum number of messages to spool.	255-1000*1
Messages to spool	The primary messages to spool.	You can enable or disable spooling individually for the following SECS messages. <ul style="list-style-type: none"> <li>• Alarm Report Send (S5,F1)</li> <li>• Event Report Send (S6,F11)</li> <li>• Trace Data Send (S6,F1)</li> <li>• Process Program Load Inquire (S7,F1)</li> <li>• Process Program Send (S7,F3)</li> <li>• Process Program Request (S7,F5)</li> <li>• Formatted Process Program Send (S7,F23)</li> <li>• Formatted Process Program Request (S7,F25)</li> <li>• Process Program Verification Send (S7,F27)</li> <li>• Terminal Request (S10,F1)</li> <li>• User-defined Messages</li> </ul>

\*1. If the format of *SpoolCountActual* (actual number of spooled messages) is U1, the maximum number of spooled messages is 255 regardless of the setting.

The error messages that may be displayed for this menu command are described in the following table.

<b>Error message</b>	<b>Cause</b>	<b>Correction</b>
An entry is empty.	As given in the error message.	Set all of the items.
The entered value is out of the specified range. [Range: xxxx to yyyy]	As given in the error message.	Set a value within the valid setting range.



## 8-12 Message Settings

The Message Settings Menu is used to define GEM standard messages and user-defined messages. This menu provides the following two commands.

- GEM Standard Messages
- User-defined Messages

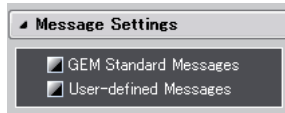

### 8-12-1 GEM Standard Messages

The **GEM Standard Messages** command is used to enable and disable SECS/GEM standard primary messages from the host and to set the W bits to ON or OFF in primary messages from the equipment.

Refer to 5-6-1 *GEM Standard Messages* on page 5-102 for details on GEM standard messages.

Enable/Disable	S	F	H	E	Description	W-bit setting
<input checked="" type="checkbox"/>	S1	F1	H←→E		Are You There Request	<input checked="" type="checkbox"/>
<input checked="" type="checkbox"/>	S1	F3	H→E		Selected Equipment Status Request	<input checked="" type="checkbox"/>
<input checked="" type="checkbox"/>	S1	F11	H→E		Status Variable Namelist Request	<input checked="" type="checkbox"/>
<input checked="" type="checkbox"/>	S1	F13	H←→E		Establish Communications Request	<input checked="" type="checkbox"/>
<input checked="" type="checkbox"/>	S1	F15	H→E		Request OFF-LINE	<input checked="" type="checkbox"/>
<input checked="" type="checkbox"/>	S1	F17	H→E		Request ON-LINE	<input checked="" type="checkbox"/>
<input checked="" type="checkbox"/>	S2	F13	H→E		Equipment Constant Request	<input checked="" type="checkbox"/>
<input checked="" type="checkbox"/>	S2	F15	H→E		New Equipment Constant Send	<input checked="" type="checkbox"/>
<input checked="" type="checkbox"/>	S2	F17	H←→E		Date and Time Request	<input checked="" type="checkbox"/>
<input checked="" type="checkbox"/>	S2	F23	H→E		Trace Initialize Send	<input checked="" type="checkbox"/>
<input checked="" type="checkbox"/>	S2	F25	H→E		Loopback Diagnostic Request	<input checked="" type="checkbox"/>
<input checked="" type="checkbox"/>	S2	F29	H→E		Equipment Constant Namelist Request	<input checked="" type="checkbox"/>
<input checked="" type="checkbox"/>	S2	F31	H→E		Date and Time Set Request	<input checked="" type="checkbox"/>
<input checked="" type="checkbox"/>	S2	F33	H→E		Define Report	<input checked="" type="checkbox"/>
<input checked="" type="checkbox"/>	S2	F35	H→E		Link Event Report	<input checked="" type="checkbox"/>
<input checked="" type="checkbox"/>	S2	F37	H→E		Enable/Disable Event Report	<input checked="" type="checkbox"/>
<input checked="" type="checkbox"/>	S2	F39	H→E		Multi-block Inquire	<input checked="" type="checkbox"/>
<input checked="" type="checkbox"/>	S2	F41	H→E		Host Command Send	<input checked="" type="checkbox"/>
<input checked="" type="checkbox"/>	S2	F43	H→E		Reset Spooling Streams and Functions	<input checked="" type="checkbox"/>
<input checked="" type="checkbox"/>	S2	F45	H→E		Define Variable Limit Attributes	<input checked="" type="checkbox"/>
<input checked="" type="checkbox"/>	S2	F47	H→E		Variable Limit Attribute Request	<input checked="" type="checkbox"/>
<input checked="" type="checkbox"/>	S2	F49	H→E		Enhanced Remote Command	<input checked="" type="checkbox"/>
<input checked="" type="checkbox"/>	S5	F1	H←E		Alarm Report Send	<input checked="" type="checkbox"/>
<input checked="" type="checkbox"/>	S5	F3	H→E		Enable/Disable Alarm Send	<input checked="" type="checkbox"/>
<input checked="" type="checkbox"/>	S5	F5	H→E		List Alarms Request	<input checked="" type="checkbox"/>

The items that are displayed in the GEM Standard Messages Dialog Box are described in the following table along with the meanings and value ranges of the items.

Item	Meaning
Enable/Disable	A setting to enable/disable the primary message from the host. Enable: Select the check box. Disable: Clear the check box.
W-bit setting	The W-bit setting for the primary message from the equipment. ON: Select the check box. OFF: Clear the check box.

## 8-12-2 User-defined Messages

The **User-defined Messages** command is used to define SECS messages prepared by the user. Refer to 5-6-2 *User-defined Messages* on page 5-104 for details on user-defined messages.

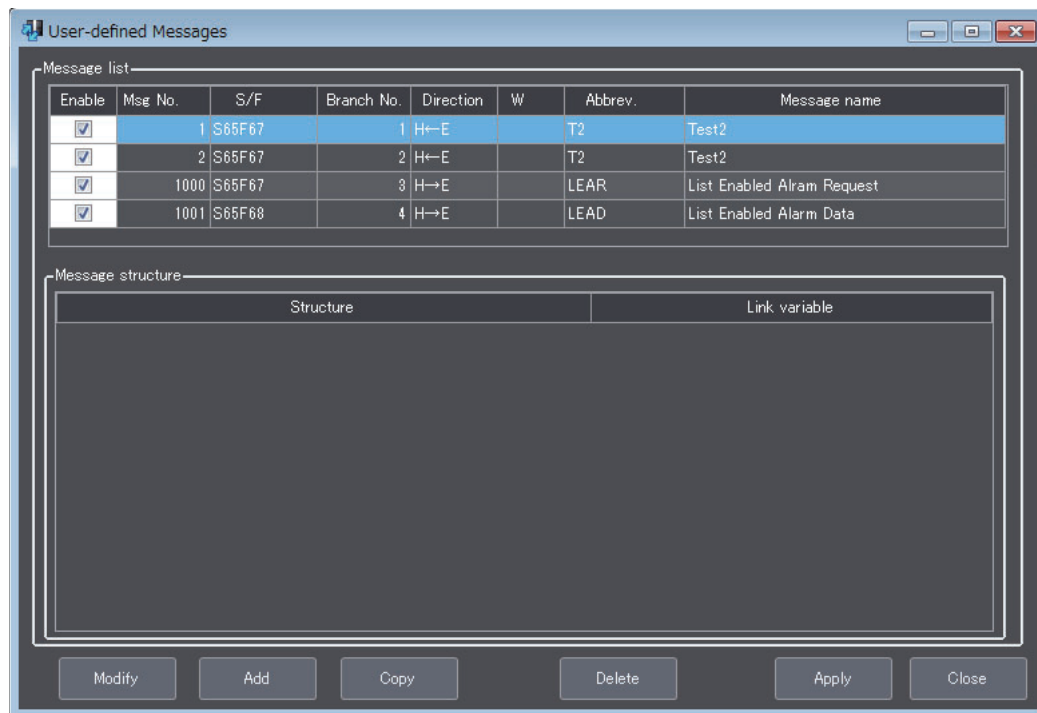

This dialog box is used to check the settings of user-defined messages in a table. The meaning of each item is given below.

The functions of the buttons in the User-defined Messages Dialog Box are given in the following table.

Button	Function
Modify	Changes the definition of a previously set user-defined message. *1
Add	Adds a new user-defined message. *1
Copy	Copies a previously set user-defined message and uses it to add a new user-defined message.
Delete	Deletes a previously set user-defined message.
Apply	Applies the settings in the currently displayed dialog box. If you close the dialog box without clicking the <b>Apply</b> Button, the settings that were made are discarded.
Close	Closes the User-defined Messages Dialog Box.

\*1. The Host Command Definition Dialog Box is displayed when you click this button.

You can click an item name to sort the list by that item.

## Setting Procedure for User-defined Messages

Use the following procedure to set a user-defined message.

- 1 Click the **Add** Button in the User-defined Messages Dialog Box.  
The Host Command Definition Dialog Box is displayed.

- 2 Set the message attributes on the Host Command Definition Dialog Box.  
The message attributes, meanings, and value ranges are given in the following table.

Item	Meaning	Range of values
MsgNo.	The SECS message number.	1-65535
Stream	The stream number of the SECS message.	1-127
Function	The function number of the SECS message.	1-255
Branch No.	An identifier for different messages that have the same stream and function numbers but different communications directions or data structures.	1-20
Direction	The communications direction of the SECS message. H→E: Host to equipment H←E: Equipment to host	H→E or H←E
Reply	Whether a secondary message is returned.*1	Yes or No
Abbrev.	An abbreviation for the SECS message.	A to Z and 0 to 9 20 characters max.
Message name	The name of the SECS message.	A to Z, a to z, 0 to 9, spaces, underscores, and hyphens 64 characters max.

\*1. Setting *Reply* to *Yes* achieves the same thing as turning ON the W bit. Setting *Reply* to *No* achieves the same thing as turning OFF the W bit.

- 3 Click the **Apply** Button.

The user-defined message with the attributes set is added to the message list in the User-defined Messages Dialog Box.

- 4** Set the message structure settings at the bottom of the Host Command Definition Dialog Box. The message structure settings, meanings, and value ranges are given in the following table.

Item	Meaning	Range of values
Format	The format of the data item.	List of fixed length data, List of length-variable data, B, BOOLEAN, A, I1, I2, I4, F4, F8, U1, U2, or U4
Fixed length	Specifies whether to use a fixed data size or a variable data size for format A.	Fixed length or variable length
Item name	The name of the data item except for the following formats: List of fixed length data or list of length-variable data.	A to Z, a to z, and 0 to 9 20 characters max.
Number of lists	The number of lists in a list of fixed length data. The maximum number of lists in a list of length-variable data.	List of fixed length data: 0 to 128 List of length-variable data: 1 to 128
Data size	For format B or A, the data size in bytes. For formats other than B and A, the number of array elements for a numeric array.	1-120
Link variable	The link variable for the data item. There are the following two link variables for a list of length-variable data. <ul style="list-style-type: none"> <li>• List element count<sup>*1</sup></li> <li>• List element table<sup>*2</sup></li> </ul>	---

\*1. The data type is UINT.

\*2. It is an array variable. The array element data type must agree with the format of the data items. The number of array elements must be equal to or greater than the maximum number of lists for the data items.

- 5** Click the **Update** Button.  
The set message structure is added to the left side of the lower part of the Host Command Definition Dialog Box.
- 6** Click the **Add** Button to set the new message structure.  
Repeat steps 4 to 6 to complete all of the message structure.
- 7** After all of the message structure is complete, click the **Apply** Button.

## Error Messages for User-defined Messages

The error messages that may be displayed for this menu command are described in the following table.

Error message	Cause	Correction
An entry is empty.	As given in the error message.	Set all of the items.
The entered value is out of the specified range. [Range: xxxx to yyyy]	As given in the error message.	Set a value within the valid setting range.
An abbreviation includes a character that cannot be used. <Usable characters> A to Z, 0 to 9	As given in the error message.	Set an abbreviation that does not contain invalid characters.
A message name includes a character that cannot be used. <Usable characters> 0 to 9, A to Z, a to z, _ (underscore), - (hyphen), (space)	As given in the error message.	Set a message name that does not contain invalid characters.
A link variable is not specified	As given in the error message.	Specify a link variable.
The message number is duplicated.	As given in the error message.	Change the value of the message number.
The S/F branch number is duplicated.	As given in the error message.	Change the value of the stream/function branch number.
The message structure is invalid.	As given in the error message.	Change the message structure.
The data type of the link variable is invalid.	As given in the error message.	Change the link variable or the item structure.
Plural items are specified without list structure definition.	As given in the error message.	Define the list structure.
Message levels exceed the specified nest levels.	More than three nesting levels are used in the list in the message.	Do not use more than three nesting levels for a message list.
The length-variable list is nested.	A list of length-variable data is set inside a list of length-variable data.	Do not nest lists of length-variable data.
The message size exceeds the maximum.	The size of the defined message exceeds 257 Kbytes.	Change the structure of the user-defined message.
An item name includes a character that cannot be used. <Usable characters> A to Z, a to z, 0 to 9	As given in the error message.	Set an item name that does not contain invalid characters.
The specified code is used for a standard Stream/Function message.	The stream and function numbers for a standard SECS message were used for a user-defined message.	Change the stream or function number.
An item name is duplicated.	As given in the error message.	Change the item name.

If there are problems in the definitions of user-defined messages, error messages will be displayed when you build the project. The error messages that may be displayed when you build the project are described in the following table.

Error message	Cause	Correction
The primary message (SxxFyy) that corresponds to the secondary message is not defined.	The primary message is not defined for a secondary message.	Define the primary message for the secondary message.
The secondary message (SxxFyy) that corresponds to the primary message is not defined.	The secondary message is not defined for a primary message that has an ON W-bit setting.	Define the secondary message. Or, change the W-bit setting of the primary message to OFF.
Different W-bit settings exist for an identical primary message (SxxFyy).	SECS messages with the same stream and function do not have the same W-bit setting.	Use the same W-bit setting for all SECS messages with the same stream and function.

# 8-13 Confirm Settings

The Confirm Settings Menu is used to display tables of the definitions of items, messages, events, reports, and alarms. This menu provides the following five commands.

- Item List
- Message List
- Event List
- Report List
- Alarm List

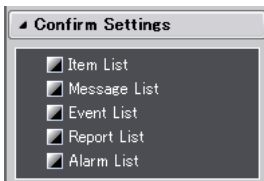

## 8-13-1 Item List

The *Item List* command displays a list of items defined in the SECS/GEM standards.

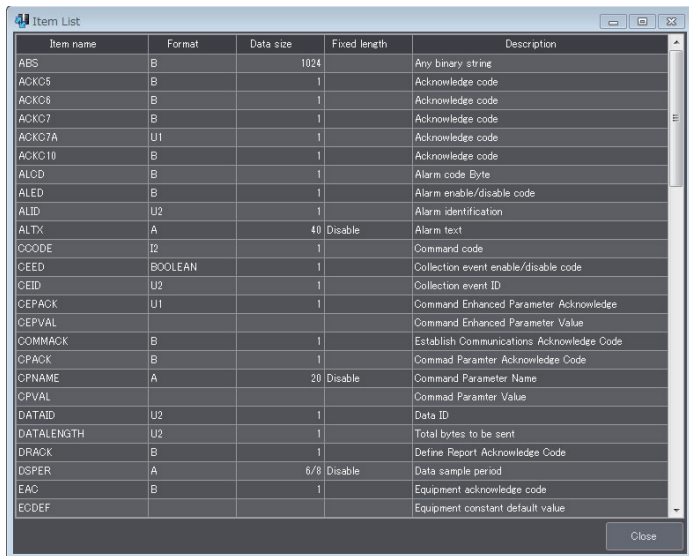

The items displayed in the Item List Dialog Box are given in the following table.

Item	Meaning
Item name	The name of the item.
Format	The format of the item.
Data size	The byte length of the item.
Fixed length	Specifies whether to use a fixed length or a variable length for format A. Enable: Fixed length Disable: Variable length
Description	A description of the item.

## 8-13-2 Message List

The **Message List** command displays a list of GEM standard messages and user-defined messages.



The items displayed in the Message List Dialog Box are given in the following table.

Item	Meaning
SF	The stream number and function number of the SECS message.
Description	The name of the SECS message.
Direction	The communications direction of the SECS message. H→E: Host to equipment H←E: Equipment to host
W-bit setting	The W-bit setting. W: ON Blank: OFF

## 8-13-3 Event List

The **Event List** command displays a list of events defined in the SECS/GEM standards and events defined by the user.

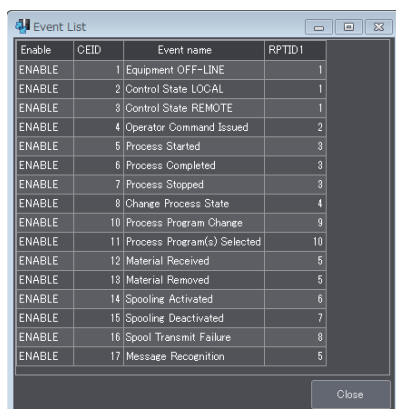

The items displayed in the Event List Dialog Box are given in the following table.

Item	Meaning
Enable	Whether the event is enabled.
CEID	CEID
Event name	The name of the event.
RPTID	The RPTID of the report to link to the event.



### 8-13-4 Report List

The **Report List** command displays a list of reports defined in the SECS/GEM standards and reports defined by the user.

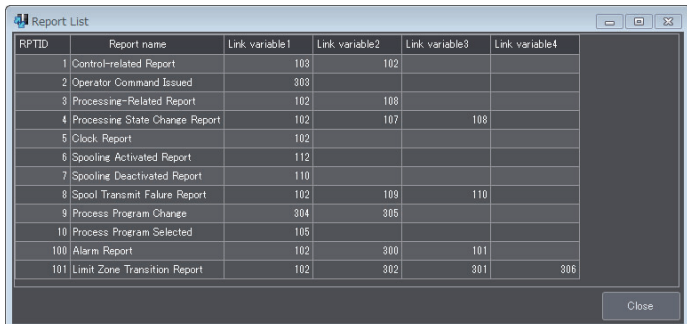

The items displayed in the Report List Dialog Box are given in the following table.

Item	Meaning
RPTID	RPTID
Report name	The name of the report.
Link variable 1 to Link variable 4	The link variables that are linked to the report.

### 8-13-5 Alarm List

The **Alarm List** command displays a list of alarms defined in the SECS/GEM standards and alarms defined by the user.

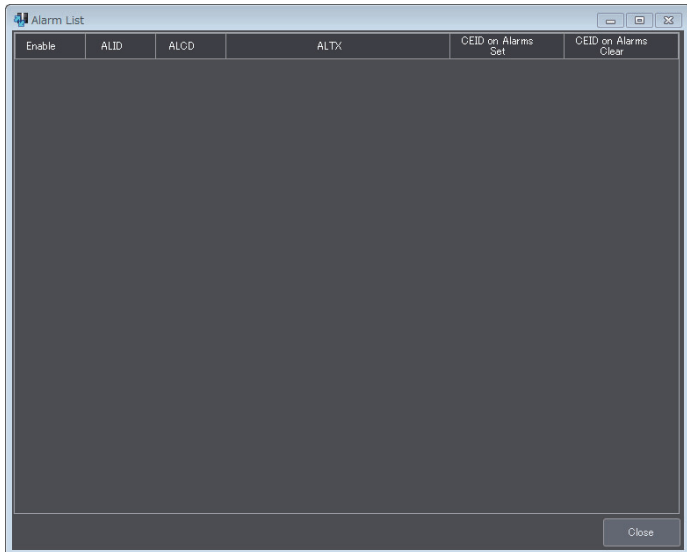

The items displayed in the Alarms List Dialog Box are given in the following table.

Item	Meaning
Enable	Whether the alarm is enabled.
ALID	ALID
ALCD	ALCD
ALTX	ALTX
CEID on Alarms Set	The CEID of the collection event that is issued when the alarm occurs.
CEID on Alarms Clear	The CEID of the collection event that is issued when the alarm is cleared.





# Troubleshooting

This section describes the following items for errors that can occur on a SECS/GEM CPU Unit: Error confirmation methods, error meanings, and error correction methods.

---

<b>9-1</b>	<b>Operation for Errors and Error Confirmation Methods</b>	<b>9-2</b>
<b>9-2</b>	<b>Errors Related to SECS/GEM</b>	<b>9-3</b>
9-2-1	Error Table	9-3
9-2-2	Error Descriptions	9-5

## 9-1 Operation for Errors and Error Confirmation Methods

---

The operation for errors and the error confirmation methods for the SECS/GEM CPU Units are the same as those for the NJ-series CPU Units.

Refer to the following manuals for detailed information on error operation and error confirmation methods for the NJ-series Standard CPU Units: *NJ/NX-series Troubleshooting Manual* (Cat. No. W503), *NJ-series CPU Unit Hardware User's Manual* (Cat. No. W500), and *NJ/NX-series CPU Unit Software User's Manual* (Cat. No. W501).

## 9-2 Errors Related to SECS/GEM

There are errors that are specific to the SECS/GEM CPU Units in addition to the errors (events) that can occur for NJ-series Standard CPU Units. This section describes the errors that are specific to SECS/GEM CPU Units. Refer to the following manuals for detailed information on errors that can occur for the NJ-series Standard CPU Units: *NJ/NX-series Troubleshooting Manual (Cat. No. W503)*, *NJ-series CPU Unit Hardware User's Manual (Cat. No. W500)*, and *NJ/NX-series CPU Unit Software User's Manual (Cat. No. W501)*.

For detailed information on errors that can occur for GEM instructions, refer to *A-1-7 Events That Occur for GEM Instruction Execution* on page A-187.

### 9-2-1 Error Table

This section provides a table of the events that can occur in a SECS/GEM CPU Unit. Event levels are given as following in the tables:

Maj: Major fault level

Prt: Partial fault level

Min: Minor fault level

Obs: Observation

Info: Information

Event code	Event name	Meaning	Assumed cause	Level					Reference
				Maj	Prt	Min	Obs	Info	
14E00000 hex	Invalid GEM Setting Data	The GEM setting data is invalid.	<ul style="list-style-type: none"> <li>The power supply to the CPU Unit was interrupted during a transfer of the setting data of the GEM Service.</li> <li>The setting data of the GEM Service is not correct because the power supply to the Controller was interrupted during a Clear All Memory operation.</li> <li>Non-volatile memory failed.</li> </ul>			✓			P. 9-6
14E20000 hex	Spool Data Discarded	The spool data is discarded.	<ul style="list-style-type: none"> <li>The spool data was discarded because the power supply to the CPU Unit was interrupted with no shutdown.</li> </ul>			✓			P. 9-6
14E30000 hex	Spool Save Failed	Failed to save the spooled data to the SD Memory Card.	<ul style="list-style-type: none"> <li>The capacity of the SD Memory Card is insufficient.</li> <li>The SD Memory Card is damaged.</li> </ul>			✓			P. 9-7
35400000 hex	Illegal Variable Allocation	Resolution of the variable allocation failed.	<ul style="list-style-type: none"> <li>The variable that is specified in the SECS/GEM Configurator does not exist in the global variables.</li> <li>The data type, constant attribute, number of array dimensions or number of array elements of the variable that is set in the SECS/GEM Configurator is different from the variable defined in the global variables.</li> </ul>			✓			P. 9-7

Event code	Event name	Meaning	Assumed cause	Level					Reference
				Maj	Prt	Min	Obs	Info	
35410000 hex	Illegal TCP Port Number	The TCP port number for the host communications is illegal.	<ul style="list-style-type: none"> <li>The TCP port number for the host communications is also used as the TCP port number of another function.</li> </ul>			✓			P. 9-8
44100000 hex	System Error in GEM Service	A system error occurred in the GEM Service.	<ul style="list-style-type: none"> <li>A system error occurred in the GEM Service.</li> </ul>			✓			P. 9-8
14E10000 hex	GEM Service Log Save Failed	An error occurred when the GEM Service log is written to the SD Memory Card.	<ul style="list-style-type: none"> <li>The capacity of the SD Memory Card is insufficient.</li> <li>The SD Memory Card is damaged.</li> </ul>				✓		P. 9-9
14E40000 hex	Invalid SD Memory Card	An SD Memory Card is not inserted or an SD Memory Card that cannot be written is inserted.	<ul style="list-style-type: none"> <li>An SD Memory Card is not inserted.</li> <li>The SD Memory Card type is not correct.</li> <li>The format of the SD Memory Card is not correct.</li> <li>The SD Memory Card is write protected.</li> </ul>				✓		P. 9-9
66000000 hex	Send Transaction Queue Overrun	The send transaction exceeded the capacity for temporary storage.	<ul style="list-style-type: none"> <li>The capacity to process the send transaction is insufficient.</li> </ul>				✓		P. 9-10
66010000 hex	Reception Transaction Queue Overrun	The reception transaction exceeded the capacity for temporary storage.	<ul style="list-style-type: none"> <li>The capacity to process the reception transaction is insufficient.</li> </ul>				✓		P. 9-10
66020000 hex	Too Long SECS Message	The SECS message to be sent to the host exceeds the maximum length.	<ul style="list-style-type: none"> <li>The SECS message to be sent to the host exceeds the maximum length.</li> </ul>				✓		P. 9-10
95420000 hex	GEM Service Started	The GEM Service started normally.	<ul style="list-style-type: none"> <li>The GEM Service started normally.</li> </ul>					✓	P. 9-11
95430000 hex	Shutdown Completed	The shutdown processing was completed normally.	<ul style="list-style-type: none"> <li>The shutdown processing was completed normally.</li> </ul>					✓	P. 9-11
95440000 hex	GEM Setting Data Changed	The setting data of the GEM Service was changed.	<ul style="list-style-type: none"> <li>The setting data of the GEM Service from the SECS/GEM Configurator was changed.</li> </ul>					✓	P. 9-11
95450000 hex	Valid SD Memory Card	An SD Memory Card that can be written is inserted.	<ul style="list-style-type: none"> <li>An SD Memory Card that can be written is inserted.</li> </ul>					✓	P. 9-12

## 9-2-2 Error Descriptions

This section describes the information that is given for individual errors.

### Error Descriptions

The items that are used to describe individual errors (events) are described in the following copy of an error table.

<b>Event name</b>	Gives the name of the error.			<b>Event code</b>	Gives the code of the error.	
<b>Meaning</b>	Gives a short description of the error.					
<b>Source</b>	Gives the source of the error.		<b>Source details</b>	Gives details on the source of the error.	<b>Detection timing</b>	Tells when the error is detected.
	<b>Level</b>	Tells the level of influence on control. *1				
<b>Error attributes</b>	<b>Level</b>	Tells the level of influence on control. *1	<b>Recovery</b>	Gives the recovery method. *2	<b>Log category</b>	Tells which log the error is saved in. *3
<b>Effects</b>	<b>User program</b>	Tells what will happen to execution of the user program. *4	<b>Operation</b>	Provides special information on the operation that results from the error.		
				<b>Variable</b>	<b>Data type</b>	<b>Name</b>
<b>System-defined variables</b>	Lists the variable names, data types, and meanings for system-defined variables that provide direct error notification, that are directly affected by the error, or that contain settings that cause the error.					
<b>Cause and correction</b>	<b>Assumed cause</b>		<b>Correction</b>		<b>Prevention</b>	
	Lists the possible causes, corrections, and preventive measures for the error.					
<b>Attached information</b>	This is the attached information that is displayed by the Sysmac Studio or an HMI. *5					
<b>Precautions/Remarks</b>	Provides precautions, restrictions, and supplemental information. If the user can set the event level, the event levels that can be set, the recovery method, operational information, and other information are also provided.					

\*1. One of the following:

- Major fault: Major fault level
- Partial fault: Partial fault level
- Minor fault: Minor fault level
- Observation
- Information

\*2. One of the following:

- Automatic recovery: Normal status is restored automatically when the cause of the error is removed.
- Error reset: Normal status is restored when the error is reset after the cause of the error is removed.
- Cycle the power supply: Normal status is restored when the power supply to the Controller is turned OFF and then back ON after the cause of the error is removed.
- Controller reset: Normal status is restored when the Controller is reset after the cause of the error is removed.
- Depends on cause: The recovery method depends on the cause of the error.

\*3. One of the following:

- System: System event log
- Access: Access event log

\*4. One of the following:

- Continues: Execution of the user program will continue.
- Stops: Execution of the user program stops.
- Starts: Execution of the user program starts.

\*5. Refer to the appendices of the *NJ/NX-series Troubleshooting Manual* (Cat. No. W503) for the applicable range of the HMI Troubleshooter.

## Errors Related to SECS/GEM

<b>Event name</b>	Invalid GEM Setting Data		<b>Event code</b>	14E00000 hex		
<b>Meaning</b>	The GEM setting data is invalid.					
<b>Source</b>	PLC Function Module		<b>Source details</b>	SECS/GEM	<b>Detection timing</b>	At download, power ON, or Controller reset
<b>Error attributes</b>	<b>Level</b>	Minor fault	<b>Recovery</b>	Automatic recovery	<b>Log category</b>	System
<b>Effects</b>	<b>User program</b>	Continues.	<b>Operation</b>	Not affected.		
<b>System-defined variables</b>	<b>Variable</b>	<b>Data type</b>		<b>Name</b>		
	None	---		---		
<b>Cause and correction</b>	<b>Assumed cause</b>		<b>Correction</b>		<b>Prevention</b>	
	The power supply to the CPU Unit was interrupted during a transfer of the setting data of the GEM Service.		Transfer the setting data of the GEM Service from the SECS/GEM Configurator.		None	
<b>Attached information</b>	The setting data of the GEM Service is not correct because the power supply to the Controller was interrupted during a Clear All Memory operation.					
<b>Precautions/Remarks</b>	Non-volatile memory failed.		Replace the CPU Unit.			
<b>Event name</b>	None					
<b>Meaning</b>	None					

<b>Event name</b>	Spool Data Discarded		<b>Event code</b>	14E20000 hex		
<b>Meaning</b>	The spool data is discarded.					
<b>Source</b>	PLC Function Module		<b>Source details</b>	SECS/GEM	<b>Detection timing</b>	While spool is active
<b>Error attributes</b>	<b>Level</b>	Minor fault	<b>Recovery</b>	Reset error	<b>Log category</b>	System
<b>Effects</b>	<b>User program</b>	Continues.	<b>Operation</b>	Not affected.		
<b>System-defined variables</b>	<b>Variable</b>	<b>Data type</b>		<b>Name</b>		
	None	---		---		
<b>Cause and correction</b>	<b>Assumed cause</b>		<b>Correction</b>		<b>Prevention</b>	
	The spool data was discarded because the power supply to the CPU Unit was interrupted with no shutdown.		Interrupt the power supply to the CPU Unit after a shutdown.		None	
<b>Event name</b>	None					
<b>Meaning</b>	None					



<b>Event name</b>	Spool Save Failed		<b>Event code</b>	14E3 0000 hex		
<b>Meaning</b>	Failed to save the spooled data to the SD Memory Card.					
<b>Source</b>	PLC Function Module		<b>Source details</b>	SECS/GEM	<b>Detection timing</b>	When communications are interrupted
<b>Error attributes</b>	<b>Level</b>	Minor fault	<b>Recovery</b>	Automatic recovery	<b>Log category</b>	System
<b>Effects</b>	<b>User program</b>	Continues.	<b>Operation</b>	Not affected.		
<b>System-defined variables</b>	<b>Variable</b>	<b>Data type</b>		<b>Name</b>		
	None	---		---		
<b>Cause and correction</b>	<b>Assumed cause</b>		<b>Correction</b>		<b>Prevention</b>	
	The capacity of the SD Memory Card is insufficient.		Replace the SD Memory Card for one with sufficient available capacity.		Replace the SD Memory Card for one with sufficient available capacity.	
	The SD Memory Card is damaged.		Replace the SD Memory Card.		Do not remove the SD Memory Card or turn OFF the power supply while the SD BUSY indicator is lit. Replace the SD Memory Card periodically according to the write life of the SD Memory Card.	
<b>Event name</b>	Attached information 1: Cause of errors 0005 hex: The capacity of the SD Memory Card is insufficient. 0302 hex: Saving the file to the SD Memory Card failed or the SD Memory Card is faulty.					
<b>Meaning</b>	None					

<b>Event name</b>	Illegal Variable Allocation		<b>Event code</b>	3540 0000 hex		
<b>Meaning</b>	Resolution of the variable allocation failed.					
<b>Source</b>	PLC Function Module		<b>Source details</b>	SECS/GEM	<b>Detection timing</b>	When the operating mode is changed
<b>Error attributes</b>	<b>Level</b>	Minor fault	<b>Recovery</b>	Automatic recovery	<b>Log category</b>	System
<b>Effects</b>	<b>User program</b>	Continues.	<b>Operation</b>	Not affected.		
<b>System-defined variables</b>	<b>Variable</b>	<b>Data type</b>		<b>Name</b>		
	None	---		---		
<b>Cause and correction</b>	<b>Assumed cause</b>		<b>Correction</b>		<b>Prevention</b>	
	The variable that is specified in the SECS/GEM Configurator does not exist in the global variables.		Check the data type and attribute of the variable that is allocated in the SECS/GEM Configurator with the variable in the global variables and set again.		None	
	The data type, constant attribute, number of array dimensions or number of array elements of the variable that is set in the SECS/GEM Configurator is different from the variable defined in the global variables.					
<b>Event name</b>	Attached information 1: Variable name					
<b>Meaning</b>	None					

<b>Event name</b>	Illegal TCP Port Number		<b>Event code</b>	35410000 hex		
<b>Meaning</b>	The TCP port number for the host communications is illegal.					
<b>Source</b>	PLC Function Module		<b>Source details</b>	SECS/GEM	<b>Detection timing</b>	At the start of host communications
<b>Error attributes</b>	<b>Level</b>	Minor fault	<b>Recovery</b>	Automatic recovery	<b>Log category</b>	System
<b>Effects</b>	<b>User program</b>	Continues.	<b>Operation</b>	Not affected.		
<b>System-defined variables</b>	<b>Variable</b>		<b>Data type</b>		<b>Name</b>	
	_GEM_HSMSParam		_sGEM_HSMS_PARAM		HSMS Communication Parameters	
<b>Cause and correction</b>	<b>Assumed cause</b>		<b>Correction</b>		<b>Prevention</b>	
	The TCP port number for the host communications is also used as the TCP port number of another function.		Change the TCP port number of another function or one for the host communications so that the same TCP port number is not used.		None	
<b>Event name</b>	Attached information 1: TCP port number					
<b>Meaning</b>	None					

<b>Event name</b>	System Error in GEM Service		<b>Event code</b>	44100000 hex		
<b>Meaning</b>	A system error occurred in the GEM Service.					
<b>Source</b>	PLC Function Module		<b>Source details</b>	SECS/GEM	<b>Detection timing</b>	Continuously
<b>Error attributes</b>	<b>Level</b>	Minor fault	<b>Recovery</b>	Automatic recovery	<b>Log category</b>	System
<b>Effects</b>	<b>User program</b>	Continues.	<b>Operation</b>	Not affected.		
<b>System-defined variables</b>	<b>Variable</b>		<b>Data type</b>		<b>Name</b>	
	None		---		---	
<b>Cause and correction</b>	<b>Assumed cause</b>		<b>Correction</b>		<b>Prevention</b>	
	A system error occurred in the GEM Service.		Contact your OMRON representative.		None	
<b>Event name</b>	Attached information 1: System information Attached information 2: System information					
<b>Meaning</b>	None					

<b>Event name</b>	GEM Service Log Save Failed		<b>Event code</b>	14E1 0000 hex		
<b>Meaning</b>	An error occurred when the GEM Service log is written to the SD Memory Card.					
<b>Source</b>	PLC Function Module		<b>Source details</b>	SECS/GEM	<b>Detection timing</b>	During communications
<b>Error attributes</b>	<b>Level</b>	Observation	<b>Recovery</b>	Automatic recovery	<b>Log category</b>	System
<b>Effects</b>	<b>User program</b>	Continues.	<b>Operation</b>	Not affected.		
<b>System-defined variables</b>	<b>Variable</b>		<b>Data type</b>		<b>Name</b>	
	None		---		---	
<b>Cause and correction</b>	<b>Assumed cause</b>		<b>Correction</b>		<b>Prevention</b>	
	The capacity of the SD Memory Card is insufficient.		Replace the SD Memory Card for one with sufficient available capacity.		Replace the SD Memory Card for one with sufficient available capacity.	
<b>Attached information</b>	The SD Memory Card is damaged.		Replace the SD Memory Card.		Do not remove the SD Memory Card or turn OFF the power supply while the SD BUSY indicator is lit. Replace the SD Memory Card periodically according to the write life of the SD Memory Card.	
<b>Precautions/Remarks</b>	Attached information 1: Cause of errors 0005 hex: The capacity of the SD Memory Card is insufficient. 0302 hex: Saving the file to the SD Memory Card failed or the SD Memory Card is faulty.					
<b>Event name</b>	None					

<b>Event name</b>	Invalid SD Memory Card		<b>Event code</b>	14E4 0000 hex		
<b>Meaning</b>	An SD Memory Card is not inserted or an SD Memory Card that cannot be written is inserted.					
<b>Source</b>	PLC Function Module		<b>Source details</b>	SECS/GEM	<b>Detection timing</b>	At power ON, at Controller reset, or when SD Memory Card is inserted
<b>Error attributes</b>	<b>Level</b>	Observation	<b>Recovery</b>	Automatic recovery	<b>Log category</b>	System
<b>Effects</b>	<b>User program</b>	Continues.	<b>Operation</b>	Not affected.		
<b>System-defined variables</b>	<b>Variable</b>		<b>Data type</b>		<b>Name</b>	
	None		---		---	
<b>Cause and correction</b>	<b>Assumed cause</b>		<b>Correction</b>		<b>Prevention</b>	
	An SD Memory Card is not inserted.		Insert an SD Memory Card.		Insert an SD Memory Card.	
	The SD Memory Card type is not correct.		Replace the SD Memory Card with an SD or SDHC card.		Replace the SD Memory Card with an SD or SDHC card.	
	The format of the SD Memory Card is not correct.		Format the SD Memory Card with the Sysmac Studio.		Use a formatted SD Memory Card.	
	The SD Memory Card is write protected.		Remove write protection from the SD Memory Card.		Make sure that the SD Memory Card is not write protected.	
<b>Event name</b>	Attached information 1: Cause of errors 0001 hex: An SD Memory Card is not inserted. 0002 hex: The SD Memory Card is faulty, the format of the SD Memory Card is not correct, or the SD Memory Card is not the correct type of card. 0003 hex: The SD Memory Card is write protected.					
<b>Meaning</b>	None					

<b>Event name</b>	Send Transaction Queue Overrun		<b>Event code</b>	66000000 hex		
<b>Meaning</b>	The send transaction exceeded the capacity for temporary storage.					
<b>Source</b>	PLC Function Module		<b>Source details</b>	SECS/GEM	<b>Detection timing</b>	During communications
<b>Error attributes</b>	<b>Level</b>	Observation	<b>Recovery</b>	Automatic recovery	<b>Log category</b>	System
<b>Effects</b>	<b>User program</b>	Continues.	<b>Operation</b>	Not affected.		
<b>System-defined variables</b>	<b>Variable</b>	<b>Data type</b>		<b>Name</b>		
	None	---		---		
<b>Cause and correction</b>	<b>Assumed cause</b>		<b>Correction</b>		<b>Prevention</b>	
	The capacity to process the send transaction is insufficient.		Increase the system service time.		Increase the system service time.	
<b>Event name</b>	None					
<b>Meaning</b>	None					

<b>Event name</b>	Reception Transaction Queue Overrun		<b>Event code</b>	66010000 hex		
<b>Meaning</b>	The reception transaction exceeded the capacity for temporary storage.					
<b>Source</b>	PLC Function Module		<b>Source details</b>	SECS/GEM	<b>Detection timing</b>	During communications
<b>Error attributes</b>	<b>Level</b>	Observation	<b>Recovery</b>	Automatic recovery	<b>Log category</b>	System
<b>Effects</b>	<b>User program</b>	Continues.	<b>Operation</b>	Not affected.		
<b>System-defined variables</b>	<b>Variable</b>	<b>Data type</b>		<b>Name</b>		
	None	---		---		
<b>Cause and correction</b>	<b>Assumed cause</b>		<b>Correction</b>		<b>Prevention</b>	
	The capacity to process the reception transaction is insufficient.		Increase the system service time.		Increase the system service time.	
<b>Event name</b>	None					
<b>Meaning</b>	None					

<b>Event name</b>	Too Long SECS Message		<b>Event code</b>	66020000 hex		
<b>Meaning</b>	The SECS message to be sent to the host exceeds the maximum length.					
<b>Source</b>	PLC Function Module		<b>Source details</b>	SECS/GEM	<b>Detection timing</b>	During host communications
<b>Error attributes</b>	<b>Level</b>	Observation	<b>Recovery</b>	---	<b>Log category</b>	System
<b>Effects</b>	<b>User program</b>	Continues.	<b>Operation</b>	Not affected.		
<b>System-defined variables</b>	<b>Variable</b>	<b>Data type</b>		<b>Name</b>		
	None	---		---		
<b>Cause and correction</b>	<b>Assumed cause</b>		<b>Correction</b>		<b>Prevention</b>	
	The SECS message to be sent to the host exceeds the maximum length.		Set the SECS message length to be less than the maximum on the SECS/GEM Configurator, and transfer the setting again.		None	
<b>Event name</b>	Attached information 1: Stream and function numbers Upper byte: Stream number Lower byte: Function number					
<b>Meaning</b>	None					

<b>Event name</b>	GEM Service Started		<b>Event code</b>	95420000 hex		
<b>Meaning</b>	The GEM Service started normally.					
<b>Source</b>	PLC Function Module		<b>Source details</b>	SECS/GEM	<b>Detection timing</b>	At power ON or Controller reset
<b>Error attributes</b>	<b>Level</b>	Information	<b>Recovery</b>	---	<b>Log category</b>	System
<b>Effects</b>	<b>User program</b>	Continues.	<b>Operation</b>	Not affected.		
<b>System-defined variables</b>	<b>Variable</b>		<b>Data type</b>		<b>Name</b>	
	None		---		---	
<b>Cause and correction</b>	<b>Assumed cause</b>		<b>Correction</b>		<b>Prevention</b>	
	The GEM Service started normally.		---		---	
<b>Event name</b>	None					
<b>Meaning</b>	None					

<b>Event name</b>	Shutdown Completed		<b>Event code</b>	95430000 hex		
<b>Meaning</b>	The shutdown processing was completed normally.					
<b>Source</b>	PLC Function Module		<b>Source details</b>	SECS/GEM	<b>Detection timing</b>	At shutdown
<b>Error attributes</b>	<b>Level</b>	Information	<b>Recovery</b>	---	<b>Log category</b>	System
<b>Effects</b>	<b>User program</b>	Continues.	<b>Operation</b>	Not affected.		
<b>System-defined variables</b>	<b>Variable</b>		<b>Data type</b>		<b>Name</b>	
	_GEM_ServiceStatus		_sGEM_SERVICE_STATUS		GEM Service Status	
<b>Cause and correction</b>	<b>Assumed cause</b>		<b>Correction</b>		<b>Prevention</b>	
	The shutdown processing was completed normally.		---		---	
<b>Event name</b>	None					
<b>Meaning</b>	None					

<b>Event name</b>	GEM Setting Data Changed		<b>Event code</b>	95440000 hex		
<b>Meaning</b>	The setting data of the GEM Service was changed.					
<b>Source</b>	PLC Function Module		<b>Source details</b>	SECS/GEM	<b>Detection timing</b>	When the setting data of the GEM Service is downloaded
<b>Error attributes</b>	<b>Level</b>	Information	<b>Recovery</b>	---	<b>Log category</b>	System
<b>Effects</b>	<b>User program</b>	Continues.	<b>Operation</b>	Not affected.		
<b>System-defined variables</b>	<b>Variable</b>		<b>Data type</b>		<b>Name</b>	
	None		---		---	
<b>Cause and correction</b>	<b>Assumed cause</b>		<b>Correction</b>		<b>Prevention</b>	
	The setting data of the GEM Service from the SECS/GEM Configurator was changed.		---		---	
<b>Event name</b>	None					
<b>Meaning</b>	None					

<b>Event name</b>	Valid SD Memory Card		<b>Event code</b>	95450000 hex		
<b>Meaning</b>	An SD Memory Card that can be written is inserted.					
<b>Source</b>	PLC Function Module		<b>Source details</b>	SECS/GEM	<b>Detection timing</b>	At power ON, at Controller reset, or when SD Memory Card is inserted
<b>Error attributes</b>	<b>Level</b>	Information	<b>Recovery</b>	---	<b>Log category</b>	System
<b>Effects</b>	<b>User program</b>	Continues.	<b>Operation</b>	Not affected.		
<b>System-defined variables</b>	<b>Variable</b>	<b>Data type</b>		<b>Name</b>		
	None	---		---		
<b>Cause and correction</b>	<b>Assumed cause</b>		<b>Correction</b>		<b>Prevention</b>	
	An SD Memory Card that can be written is inserted.		---		---	
<b>Event name</b>	None					
<b>Meaning</b>	None					



# Appendices

The appendices provide details on the GEM instructions and system-defined variables.

---

<b>A-1</b>	<b>GEM Instructions</b>	<b>A-3</b>
A-1-1	Table of GEM Instructions	A-3
A-1-2	Common Variables in GEM Instructions	A-4
A-1-3	Common Precautions for Correct Use of GEM Instructions	A-4
A-1-4	Error Codes That Occur for GEM Instruction Execution	A-5
A-1-5	Global Variables Used in the Sample Programming for GEM Instructions	A-6
A-1-6	Specifications of Individual GEM Instructions	A-9
A-1-7	Events That Occur for GEM Instruction Execution	A-187
<b>A-2</b>	<b>System-defined Variables</b>	<b>A-211</b>
A-2-1	GEM Service Version	A-212
A-2-2	Equipment Information	A-212
A-2-3	GEM Service Status	A-212
A-2-4	SECS Communications	A-213
A-2-5	Interlocks	A-215
A-2-6	HSMS Communications	A-215
A-2-7	Communications State Model	A-218
A-2-8	Equipment Processing State	A-218
A-2-9	Control State Model	A-218
A-2-10	Remote Control	A-219
A-2-11	Equipment Constants	A-220
A-2-12	Process Program Management	A-220
A-2-13	Equipment Terminal Services	A-224
A-2-14	Error Messages	A-226
A-2-15	Clock	A-227
A-2-16	Spooling	A-227
A-2-17	User-defined Messages	A-228
<b>A-3</b>	<b>Correspondence between Formats and Data Types</b>	<b>A-230</b>
<b>A-4</b>	<b>Designing Tasks to Use the GEM Services</b>	<b>A-231</b>
A-4-1	GEM Service Startup Time	A-231
A-4-2	Communications Performance of GEM Instructions	A-232
A-4-3	Checking the Task Execution Time Ratio	A-234
<b>A-5</b>	<b>Basic Specifications, Performance Specifications, and Functional Specifications</b>	<b>A-235</b>

**A-6 Version Information . . . . .A-236**  
A-6-1 Checking Versions . . . . .A-236  
A-6-2 Relationship between Unit Version and GEM Service Version . . . . .A-236  
A-6-3 Relationship between Unit Version and Sysmac Studio Version . . . . .A-237  
A-6-4 Combinations of Versions That Require Attention and How to Deal with Them . . .  
A-237



# A-1 GEM Instructions

This appendix provides a table of GEM instructions, instruction specifications, and error codes/events for instruction execution.

## A-1-1 Table of GEM Instructions

A

Instruction	Name	Function	Page
GEM_ControlService	Control GEM Service Status	Changes the GEM Service status to EQInitializing or EQRun.	P. A-10
GEM_Shutdown	Shutdown GEM Service	Shuts down the GEM Service.	P. A-14
GEM_GetCommLog	Get SECS Communications Log	Gets the SECS communications log.	P. A-17
GEM_SetHSMS Param	Set HSMS Communications Parameters	Sets HSMS communications.	P. A-20
GEM_ChangeCommState	Change Communications State	Changes the equipment communications state to the specified state. The communications states are defined in the communications state model.	P. A-25
GEM_ChangeControlState	Change Control State	Changes the equipment control state to the specified state and reports the event to the host. The control states are defined in the equipment control state model.	P. A-32
GEM_InitEvent	Initialize Events	Initializes event information.	P. A-38
GEM_ReportEvent	Report Event	Reports events to the host.	P. A-41
GEM_ReportAlarm	Report Alarm	Reports alarms and events to the host.	P. A-45
GEM_AckHostCmd	Acknowledge Host Command	Sends the execution accept/reject result in reply to an execution request for a host command.	P. A-50
GEM_AckEnhancedRmtCmd	Acknowledge Enhanced Remote Command	Sends the execution accept/reject result in reply to an execution request for an enhanced remote command.	P. A-60
GEM_ChangeECV	Change Equipment Constant	Changes the value of an equipment constant.	P. A-65
GEM_AckChangeECV	Acknowledge Equipment Constant Change	Sends the equipment constant change accept/reject result in reply to an equipment constant change request from the host.	P. A-71
GEM_AckPPDelete	Acknowledge Process Program Deletion	Sends a deletion accept/reject result in reply to a process program deletion request from the host.	P. A-76
GEM_RespFormattedPPUpload	Respond to Formatted Process Program Upload	Sends the formatted process program in reply to an upload formatted process program request from the host.	P. A-82
GEM_RespPPUpload	Respond to Process Program Upload	Sends the process program in reply to a process program upload request from the host.	P. A-91
GEM_UploadFormattedPP	Upload Formatted Process Program	Uploads a formatted process program to the host.	P. A-98
GEM_UploadPP	Upload Process Program	Uploads a process program to the host.	P. A-107
GEM_AckFormattedPPDownload	Acknowledge Formatted Process Program Download	Sends the accept/reject result in reply to a request for a formatted process program download from the host.	P. A-115
GEM_AckPPDownload	Acknowledge Process Program Download	Sends the accept/reject result in reply to a request for a process program download from the host.	P. A-125
GEM_RequestFormattedPPDownload	Request Formatted Process Program Download	Sends a request for a formatted process program download to the host.	P. A-132
GEM_RequestPPDownload	Request Process Program Download	Sends a process program download request to the host.	P. A-142

Instruction	Name	Function	Page
GEM_SendPPVerify	Send Process Program Verification Result	Sends the formatted process program verification result to the host.	P. A-151
GEM_SendTerminalMsg	Send Equipment Terminal Message	Sends an equipment terminal message to the host.	P. A-155
GEM_AckTerminalMsgSB	Acknowledge Single-block Equipment Terminal Message	Sends the terminal message display result for a single-block equipment terminal message received from the host.	P. A-160
GEM_AckTerminalMsgMB	Acknowledge Multi-block Equipment Terminal Message	Sends the terminal message display result for a multi-block equipment terminal message received from the host.	P. A-165
GEM_RequestChangeTime	Request Time Change	Gets the time from the host and changes the controller time.	P. A-171
GEM_SendEquipUserMsg	Send Equipment-initiated User-defined Message	Sends a user-defined message to the host.	P. A-175
GEM_RespHostUserMsg	Respond to Host-initiated User-defined Message	Returns the user-defined message with the specified message number as the reply for a user-defined message received from the host.	P. A-182

### A-1-2 Common Variables in GEM Instructions

The following common variables are used in GEM instructions: *Execute*, *Done*, *Busy*, *Error*, and *ErrorID*.

- For specifications and timing charts, refer to the *NJ/NX-series Instructions Reference Manual* (Cat. No. W502).
- The output values for Simulator execution are given in the following table.

Output variable	Meaning	Data type	Execution result
Done	Done	BOOL	TRUE: Normal end FALSE: Error end, execution in progress, or execution condition not met.
Busy	Busy	BOOL	TRUE: Execution processing is in progress. FALSE: Execution processing is not in progress.
Error	Error	BOOL	TRUE: Error end FALSE: Normal end, execution in progress, or execution condition not met.
ErrorID	Error code	WORD	Error end: Error code Normal end: WORD16#0

### A-1-3 Common Precautions for Correct Use of GEM Instructions

- The operation of GEM instructions depends on the communications states and control states defined in SEMI E30. Check the specifications for each GEM instruction.
- Execution of this instruction is continued until processing is completed even if the value of *Execute* changes to FALSE or the execution time exceeds the task period. The value of *Done* changes to TRUE when processing is completed. Use this to confirm normal end of processing.
- You cannot use GEM instructions in an event task.
- You can execute a maximum of 32 GEM instructions at the same time. If you execute more than 32 instructions at the same time, *Error* will change to TRUE.

- Set the user-defined variables for GEM instructions to the same data types and variable names as those set with the SECS/GEM Configurator. The names of user-defined variables and their settings on the SEC/GEM Configurator are given in the user-defined variable sections for the related GEM instructions.
- The operation is as follows when more than one GEM instruction is executed at the same time:
  - a) Executing the Same GEM Instructions at the Same Time.  
The operation depends on the instruction. Check the specifications for each instruction.
  - b) Executing Different GEM Instructions at the Same Time  
The instructions are processed one at a time.  
A timing chart is provided below.

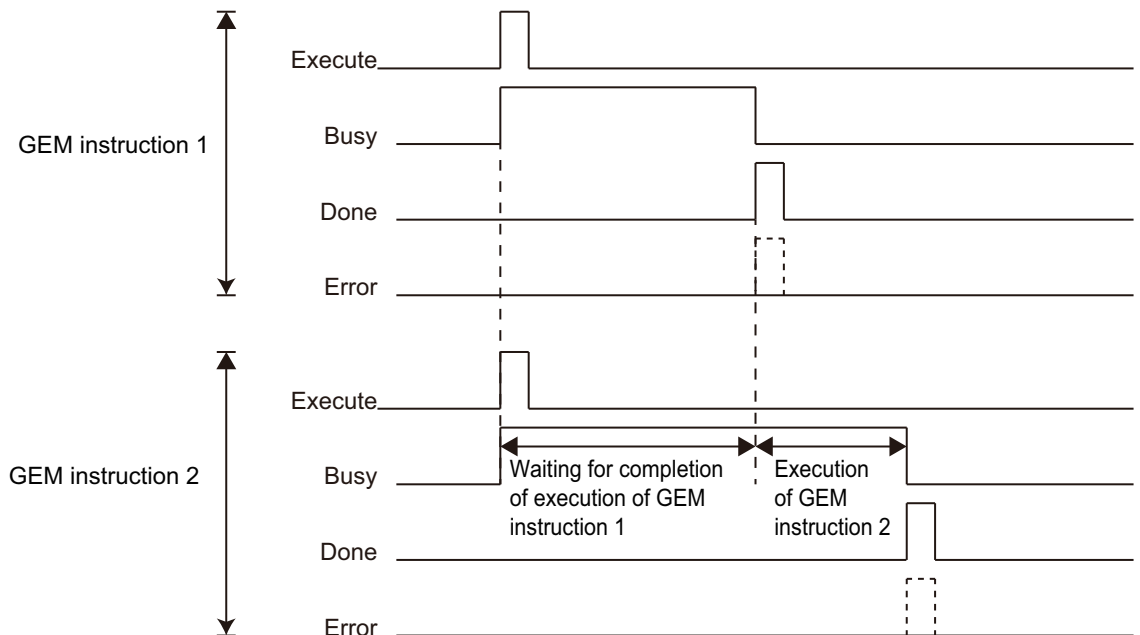

- Do not change the status of the system-defined variables and user-defined variables that are accessed by an instruction to execute until the *Done* output variable from the instruction changes to TRUE.

## A-1-4 Error Codes That Occur for GEM Instruction Execution

Error codes are assigned to the errors that can occur when instructions are executed. You can use the error code output variable (*ErrorID*) to program error processing.

Lists of the error codes that can occur for the individual instructions are given in the following individual instruction specifications. For details on error codes, refer to *A-1-7 Events That Occur for GEM Instruction Execution* on page A-187.

The priority of the error codes stored in *ErrorID* when more than one error cause occurs at the same time is the same as the order in which the error codes are listed for each instruction.

## A-1-5 Global Variables Used in the Sample Programming for GEM Instructions

Sample programming is provided in the descriptions of individual GEM instructions. If you want to use the sample programming on the Sysmac Studio, you must register the following variables in the global variable table.

Name	Data type	Retain	Constant	Network Publish	Comment
CHANGE_ECID_NUMBER	UINT	FALSE	FALSE	Do not publish	Number of Change Notification ECIDs
CHANGE_ECID_TABLE	ARRAY[0..9] OF UINT	FALSE	FALSE	Do not publish	Change Notification ECID Table
CHANGEREQ_ECID_NUMBER	UINT	FALSE	FALSE	Do not publish	Number of Change Request ECIDs
CHANGEREQ_ECID_TABLE	ARRAY[0..9] OF UINT	FALSE	FALSE	Do not publish	Change Request ECID Table
DELETE_PP_NUMBER	UINT	FALSE	FALSE	Do not publish	PPID count
DELETE_PP_TABLE	ARRAY[0..4] OF STRING[81]	FALSE	FALSE	Do not publish	PPID table
EQUIP_DOWNLOAD_FPP_CC CODE_NUMBER	UINT	FALSE	FALSE	Do not publish	Equipment-initiated download CCODE count
EQUIP_DOWNLOAD_FPP_CC CODE_TABLE	ARRAY[0..1] OF INT	FALSE	FALSE	Do not publish	Equipment-initiated download CCODE table
EQUIP_DOWNLOAD_FPP_MD LN	STRING[7]	FALSE	FALSE	Do not publish	Equipment-initiated download MDLN
EQUIP_DOWNLOAD_FPP_PP ARM1_NUMBER	UINT	FALSE	FALSE	Do not publish	Equipment-initiated formatted download, PPARM count for CCODE = 1
EQUIP_DOWNLOAD_FPP_PP ARM1_TABLE	ARRAY[0..2] OF INT	FALSE	FALSE	Do not publish	Equipment-initiated formatted download, PPARM table for CCODE = 1
EQUIP_DOWNLOAD_FPP_PP ARM2_NUMBER	UINT	FALSE	FALSE	Do not publish	Equipment-initiated formatted download, PPARM count for CCODE = 2
EQUIP_DOWNLOAD_FPP_PP ARM2_TABLE	ARRAY[0..1] OF UINT	FALSE	FALSE	Do not publish	Equipment-initiated formatted download, PPARM for table CCODE = 2
EQUIP_DOWNLOAD_FPP_PP ID	STRING[81]	FALSE	FALSE	Do not publish	Equipment-initiated download PPID
EQUIP_DOWNLOAD_FPP_S OF TREV	STRING[7]	FALSE	FALSE	Do not publish	Equipment-initiated download SOFTREV
EQUIP_DOWNLOAD_PP BODY	ARRAY[0..1023] OF BYTE	FALSE	FALSE	Do not publish	Equipment-initiated download PPBODY
EQUIP_DOWNLOAD_PP ID	STRING[81]	FALSE	FALSE	Do not publish	Equipment-initiated download PPID
EQUIP_DOWNLOAD_L EN GTH	UINT	FALSE	FALSE	Do not publish	Equipment-initiated download LENGTH
EQUIP_UPLOAD_FPP_CC CODE_TABLE	ARRAY[0..1] OF INT	FALSE	FALSE	Do not publish	Equipment-initiated upload CCODE table

Name	Data type	Retain	Con-stant	Network Publish	Comment
EQUIP_UPLOAD_FPP_PPARM1_NUMBER	UINT	FALSE	FALSE	Do not publish	Equipment-initiated formatted upload, PPARAM count for CCODE = 1
EQUIP_UPLOAD_FPP_PPARM1_TABLE	ARRAY[0..2] OF INT	FALSE	FALSE	Do not publish	Equipment-initiated formatted upload, PPARAM table for CCODE = 1
EQUIP_UPLOAD_FPP_PPARM2_NUMBER	UINT	FALSE	FALSE	Do not publish	Equipment-initiated formatted upload, PPARAM count for CCODE = 1
EQUIP_UPLOAD_FPP_PPARM2_TABLE	ARRAY[0..1] OF UINT	FALSE	FALSE	Do not publish	Equipment-initiated formatted upload, PPARAM table for CCODE = 2
EQUIP_UPLOAD_PPBODY	ARRAY[0..1023] OF BYTE	FALSE	FALSE	Do not publish	Equipment-initiated upload PPBODY
FPP_VERIFY_ACKC7A_TABLE	ARRAY[0..1] OF USINT	FALSE	FALSE	Do not publish	Verification result: ACKC7A table
FPP_VERIFY_ERRW7_TABLE	ARRAY[0..1] OF STRING[41]	FALSE	FALSE	Do not publish	Verification result: ERRW7 table
FPP_VERIFY_SEQNUM_TABLE	ARRAY[0..1] OF UINT	FALSE	FALSE	Do not publish	Verification result: SEQNUM table
HOST_DOWNLOAD_FPP_CCODE_NUMBER	UINT	FALSE	FALSE	Do not publish	Host-initiated formatted download, CCODE count
HOST_DOWNLOAD_FPP_CCODE_TABLE	ARRAY[0..1] OF INT	FALSE	FALSE	Do not publish	Host-initiated formatted download, CCODE table
HOST_DOWNLOAD_FPP_MDLN	STRING[7]	FALSE	FALSE	Do not publish	Host-initiated formatted download MDLN
HOST_DOWNLOAD_FPP_PPARM1_NUMBER	UINT	FALSE	FALSE	Do not publish	Host-initiated formatted download, PPARAM count for CCODE = 1
HOST_DOWNLOAD_FPP_PPARM1_TABLE	ARRAY[0..2] OF INT	FALSE	FALSE	Do not publish	Host-initiated formatted download, PPARAM table for CCODE = 1
HOST_DOWNLOAD_FPP_PPARM2_NUMBER	UINT	FALSE	FALSE	Do not publish	Host-initiated formatted download, PPARAM count for CCODE = 2
HOST_DOWNLOAD_FPP_PPARM2_TABLE	ARRAY[0..1] OF UINT	FALSE	FALSE	Do not publish	Host-initiated formatted download, PPARAM table for CCODE = 2
HOST_DOWNLOAD_FPP_PPID	STRING[81]	FALSE	FALSE	Do not publish	Host-initiated formatted download PPID
HOST_DOWNLOAD_FPP_SOFTREV	STRING[7]	FALSE	FALSE	Do not publish	Host-initiated formatted download SOFTREV
HOST_DOWNLOAD_PPBODY	ARRAY[0..1023] OF BYTE	FALSE	FALSE	Do not publish	Host-initiated download PPBODY
HOST_DOWNLOAD_PPID	STRING[81]	FALSE	FALSE	Do not publish	Host-initiated download PPID
HOST_DOWNLOAD_LENGTH	UINT	FALSE	FALSE	Do not publish	Host-initiated download LENGTH
HOST_UPLOAD_FPP_CCODE_TABLE	ARRAY[0..1] OF INT	FALSE	FALSE	Do not publish	Host-initiated upload CCODE table
HOST_UPLOAD_FPP_PPARM1_NUMBER	UINT	FALSE	FALSE	Do not publish	Host-initiated formatted upload, PPARAM count for CCODE = 1

Name	Data type	Retain	Constant	Network Publish	Comment
HOST_UPLOAD_FPP_PPARM1_TABLE	ARRAY[0..2] OF INT	FALSE	FALSE	Do not publish	Host-initiated formatted upload, PPRAM table for CCODE = 1
HOST_UPLOAD_FPP_PPARM2_NUMBER	UINT	FALSE	FALSE	Do not publish	Host-initiated formatted upload, PPARM count for CCODE = 2
HOST_UPLOAD_FPP_PPARM2_TABLE	ARRAY[0..1] OF UINT	FALSE	FALSE	Do not publish	Host-initiated formatted upload, PPRAM table for CCODE = 2
HOST_UPLOAD_PPBODY	ARRAY[0..1023] OF BYTE	FALSE	FALSE	Do not publish	Host-initiated upload PPBODY
HOST_UPLOADREQ_PPID	STRING[81]	FALSE	FALSE	Do not publish	Host-initiated upload request PPID
HOST_UPLOADREQ_FPP_PPID	STRING[81]	FALSE	FALSE	Do not publish	Host-initiated formatted upload request PPID
HOST_UPLOADREQ_PPID	STRING[81]	FALSE	FALSE	Do not publish	Host-initiated upload request PPID
PPID_TABLE	ARRAY[0..4] OF STRING[81]	TRUE	FALSE	Do not publish	PPID management table
S2F25_00001_Var	ARRAY[0..9] OF BYTE	FALSE	FALSE	Do not publish	User-defined message S2,F25
S2F26_00002_Var	ARRAY[0..9] OF BYTE	FALSE	FALSE	Do not publish	User-defined message S2,F26
S2F41_CPNAME_NUMBER	UINT	FALSE	FALSE	Do not publish	S2,F41: CPNAME Count
S2F41_CPNAME_TABLE	ARRAY[0..2] OF STRING[21]	FALSE	FALSE	Do not publish	S2,F41: CPNAME table
S2F41_RCMD	STRING[21]	FALSE	FALSE	Do not publish	S2,F41: RCMD variable name
S2F41_START_LOTID	STRING[17]	FALSE	FALSE	Do not publish	CPVAL of LOTID in START host command
S2F41_START_MID	STRING[17]	FALSE	FALSE	Do not publish	CPVAL of MID in START host command
S2F41_START_PPID	STRING[81]	FALSE	FALSE	Do not publish	CPVAL of PPID in START host command
S2F42_CPACK_TABLE	ARRAY[0..2] OF BYTE	FALSE	FALSE	Do not publish	S2,F42: CPACK table
S2F42_CPNAME_TABLE	ARRAY[0..2] OF STRING[21]	FALSE	FALSE	Do not publish	S2,F42: Error CPNAME table
TERMINAL_MSG_MB_NUMBER	UINT	FALSE	FALSE	Do not publish	Displayed TEXT of multi-block terminal message - Displayed TEXT Count
TERMINAL_MSG_MB_TABLE	ARRAY[0..9] OF STRING[161]	FALSE	FALSE	Do not publish	Displayed TEXT of multi-block terminal message - Displayed TEXT Table
TERMINAL_MSG_SB_TEXT	STRING[161]	FALSE	FALSE	Do not publish	Link variable for displayed TEXT of single-block terminal messages - Displayed TEXT

## A-1-6 Specifications of Individual GEM Instructions

This section provides the specifications of the individual GEM instructions that are listed in the table of GEM instructions.

# GEM\_ControlService

The GEM\_ControlService instruction changes the GEM Service status to EQinitializing or EQRun.

Instruction	Name	FB/ FUN	Graphic expression	ST expression
GEM_ControlService	Control GEM Service Status	FB		GEM_ControlService_instance(Execute, Cmd, Done, Busy, Error, ErrorID);

## Variables

Name	Meaning	I/O	Description	Valid range	Unit	Default
Cmd	Command	Input	Command to execute	_GEM_CMD_EQINIT, _GEM_CMD_EQRUN	---	_GEM_CMD_EQINIT

	Boolean	Bit strings				Integers							Real numbers		Times, durations, dates, and text strings					
	BOOL	BYTE	WORD	DWORD	LWORD	USINT	UINT	UDINT	ULINT	SINT	INT	DINT	LINT	REAL	LREAL	TIME	DATE	TOD	DT	STRING
Cmd	Refer to <i>Function</i> for the enumerators of the enumerated type <code>_eGEM_CMD</code> .																			

## Function

The GEM\_ControlService instruction changes the GEM Service status to the status specified with *Cmd*.

The data type of *Cmd* is enumerated type `_eGEM_CMD`. The changes in the GEM Service status for the values of the enumerator are given in the following table.

Enumerator	Change in GEM Service status
_GEM_CMD_EQINIT	The status changes to EQinitializing.
_GEM_CMD_EQRUN	The status changes to EQRun.

## Related System-defined Variables

Name	Meaning	Data type	Description
_GEM_ServiceStatus	GEM Service Status	_sGEM_SERVICE_STATUS	Gives the GEM Service status. Refer to P. A-212 for details.



## Related Error Codes

Error code	Name	Description
16#0400	Input Value Out of Range	The value of <i>Cmd</i> is outside of the valid range.
16#041D	Exceeded Simultaneous Instruction Executed Resources	The number of simultaneously executed GEM instructions exceeded the limit.
16#3810	GEM Service Status in Initializing	The instruction was executed when the GEM Service status was Initializing.
16#3811	GEM Service Status in EQStarting	The instruction was executed with <code>_GEM_CMD_EQRUN</code> specified for <i>Cmd</i> when the GEM Service status was EQStarting.
16#3812	GEM Service Status in EQInitializing	The instruction was executed with <code>_GEM_CMD_EQINT</code> specified for <i>Cmd</i> when the GEM Service status was EQInitializing.
16#3813	GEM Service Status in EQRun	The instruction was executed with <code>_GEM_CMD_EQRUN</code> specified for <i>Cmd</i> when the GEM Service status was EQRun.
16#3814	GEM Service Status in Stop	The instruction was executed when the GEM Service status was Stop.
16#3815	GEM Service Status in Error	The instruction was executed when the GEM Service status was Error.
16#3816	GEM Service Status in ShuttingDown	The instruction was executed when the GEM Service status was ShuttingDown.
16#3817	GEM Service Status in Shutdown	The instruction was executed when the GEM Service status was Shutdown.

## Precautions for Correct Use

- Check `_GEM_ServiceStatus` before you execute this instruction. If the instruction is executed for a value of *Cmd* in any status other than those given as OK in the following table, an error will occur and *Error* will change to TRUE.

Specified value of <i>Cmd</i>	GEM Service Status			
	EQStarting status	EQInitializing status	EQRun status	Other status
<code>_GEM_CMD_EQINIT</code>	OK	Error	OK	Error
<code>_GEM_CMD_EQRUN</code>	Error	OK	Error	Error

## Sample Programming

In this sample, the GEM Service status is changed to EQInitializing or EQRun.

- If the GEM Service status is EQStarting or EQRun and the `EQInit_Start` internal variable changes from FALSE to TRUE, the GEM Service status changes to EQInitializing.
- If the GEM Service status is EQInitializing and the `EQRun_Start` internal variable changes from FALSE to TRUE, the GEM Service status changes to EQRun.

# LD

Internal Variables	Variable	Data type	Initial value	Comment
	EQInit_Start	BOOL	FALSE	Flag to start changing to EQInitializing
	EQRun_Start	BOOL	FALSE	Flag to start changing to EQRun
	cmdGEMService	_eGEM_CMD	_GEM_CMD _CMD _EQINIT	Command to change the status
	ControlService_instance	GEM_ControlService		Instance of GEM_ControlService instruction

External Variables	Variable	Comment
	_GEM_ServiceStatus	GEM Service status

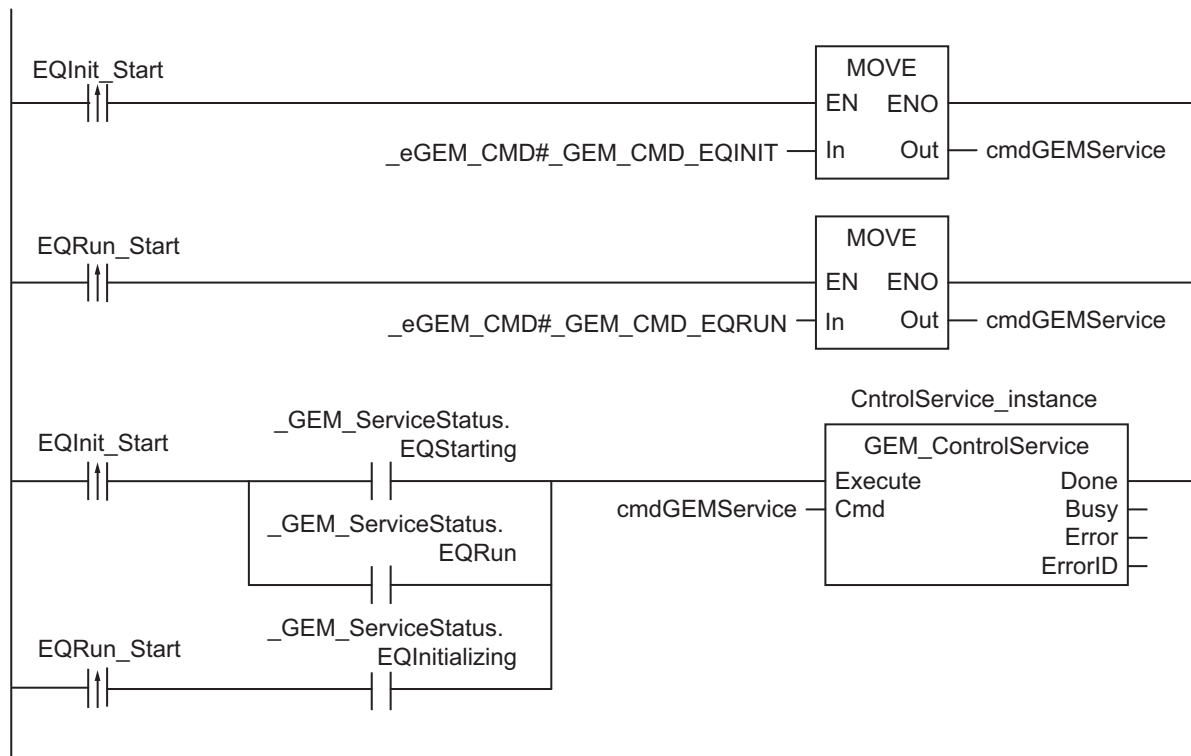

**ST**

Internal Variables	Variable	Data type	Initial value	Comment
	EQInit_Start	BOOL	FALSE	Flag to start changing from EQStarting or EQRun to EQInitializing
	EQRun_Start	BOOL	FALSE	Flag to start changing to EQRun
	cmdGEMService	_eGEM_CMD	_GEM_CMD_EQINIT	Command to change the status
	R_TRIG_EQInit_instance	R_TRIG		Instance of R_TRIG instruction for EQInit
	R_TRIG_EQRun_instance	R_TRIG		Instance of R_TRIG instruction for EQRun
	Trigger_EQInit	BOOL	FALSE	Flag for FALSE to TRUE change in <i>EQInit_Start</i>
	Trigger_EQRun	BOOL	FALSE	Flag for FALSE to TRUE change in <i>EQRun_Start</i>
	ControlService_instance	GEM_Control-Service		Instance of GEM_ControlService instruction
	Stage	INT	0	Program execution status

External Variables	Variable	Comment
	_GEM_ServiceStatus	GEM Service status

```

CASE Stage Of
0:
  R_TRIG_EQInit_instance( EQInit_Start, Trigger_EQInit );
  R_TRIG_EQRun_instance( EQRun_Start, Trigger_EQRun );
  IF( ( Trigger_EQInit = TRUE )
      AND ( ( _GEM_ServiceStatus.EQStarting = TRUE ) OR ( _GEM_ServiceStatus.EQRun =
TRUE ) ) ) THEN
    cmdGEMService := _eGEM_CMD#_GEM_CMD_EQINIT;
  ELSIF( ( Trigger_EQRun = TRUE )
      AND ( _GEM_ServiceStatus.EQInitializing = TRUE ) ) THEN
    cmdGEMService := _eGEM_CMD#_GEM_CMD_EQRUN;
  ELSE
    RETURN;
  END_IF;
  // Initialization
  ControlService_instance( Execute:=FALSE );
  Stage := 1;
1:
  ControlService_instance( Execute:=TRUE, cmd:= cmdGEMService );
  IF( ControlService_instance.Done = TRUE ) THEN
    Stage := 10;
  ELSIF( ControlService_instance.Error = TRUE ) THEN
    // Add error processing as required.
    Stage := 10;
  END_IF;
10: // End
  Stage := 0;
END_CASE;
    
```

# GEM\_Shutdown

The GEM\_Shutdown instruction shuts down the GEM Service.

Instruction	Name	FB/ FUN	Graphic expression	ST expression
GEM_Shutdown	Shutdown GEM Service	FB		GEM_Shutdown_instance( Execute, Done, Busy, Error, ErrorID);

## Variables

Only common variables are used.

## Function

The GEM\_Shutdown instruction shuts down the GEM Service.

During execution of the instruction, the `_GEM_ServiceStatus` system-defined variable is ShuttingDown. If execution ends normally, it changes to Shutdown.

## Related System-defined Variables

Name	Meaning	Data type	Description
<code>_GEM_ServiceStatus</code>	GEM Service Status	<code>_sGEM_- SER- VICE_STAT US</code>	Gives the GEM Service status. Refer to P. A-212 for details.

## Related Error Codes

Error code	Name	Description
16#041D	Exceeded Simultaneous Instruction Executed Resources	The number of simultaneously executed GEM instructions exceeded the limit.
16#3810	GEM Service Status in Initializing	The instruction was executed when the GEM Service status was Initializing.
16#3816	GEM Service Status in ShuttingDown	The instruction was executed when the GEM Service status was ShuttingDown.
16#3817	GEM Service Status in Shutdown	The instruction was executed when the GEM Service status was Shutdown.

## Precautions for Correct Use

- Check `_GEM_ServiceStatus` before you execute this instruction. If you execute this instruction when `_GEM_ServiceStatus` is ShuttingDown or Shutdown, an error will occur and `Error` will change to TRUE.
- Execute this instruction before you turn OFF the power supply to the controller. If you do not execute this instruction before you turn OFF the power supply to the controller, the data in internal non-volatile memory or on the SD Memory Card may be corrupted.

## Sample Programming

This sample shuts down the GEM Services.

If the GEM Service status is ShuttingDown or Shutdown and the `Shutdown_Start` internal variable changes from FALSE to TRUE, the GEM Services are shut down.

### LD

Internal Variables	Variable	Data type	Initial value	Comment
	Shutdown_Start	BOOL	FALSE	Flag to start shutting down the GEM Services
	Shutdown_instance	GEM_Shutdown		Instance of GEM_Shutdown instruction

External Variables	Variable	Comment
	<code>_GEM_ServiceStatus</code>	GEM Service status

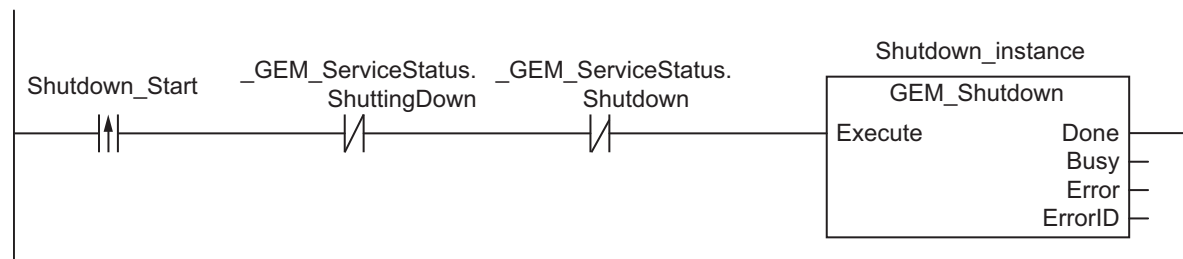

## ST

Internal Variables	Variable	Data type	Initial value	Comment
	Shutdown_Start	BOOL	FALSE	Flag to start shutting down the GEM Services
	R_TRIG_instance	R_TRIG		Instance of R_TRIG instruction
	Trigger	BOOL	FALSE	Flag for FALSE to TRUE change in <i>Shutdown_Start</i>
	Shutdown_instance	GEM_Shutdown		Instance of GEM_Shutdown instruction
	Stage	INT	0	Program execution status

External Variables	Variable	Comment
	<u>_GEM_ServiceStatus</u>	GEM Service status

```

CASE Stage Of
0:
  R_TRIG_instance( Shutdown_Start, Trigger );
  IF( ( Trigger = TRUE )
    AND ( (_GEM_ServiceStatus.ShuttingDown = FALSE) AND (_GEM_ServiceStatus.Shutdown
= FALSE) ) ) THEN
    // Initialization
    Shutdown_instance( Execute:=FALSE );
    Stage := 1;
    END_IF;
1: // Start send.
  Shutdown_instance( Execute:=TRUE );
  IF( Shutdown_instance.Done = TRUE ) THEN
    Stage := 10;
  ELSIF( Shutdown_instance.Error = TRUE ) THEN
    // Add error processing as required.
    Stage := 10;
  END_IF;
10: // End
  Stage := 0;
END_CASE;

```

# GEM\_GetCommLog

The GEM\_GetCommLog instruction gets the SECS communications log.

Instruction	Name	FB/ FUN	Graphic expression	ST expression
GEM_GetCommLog	Get SECS Communications Log	FB		GEM_GetCommLog_instance( Execute, Done, Busy, Error, ErrorID);

## Variables

Only common variables are used.

## Function

The GEM\_GetCommLog instruction gets the SECS communications log.

You can get up to 100 log records with each execution of the instruction.

The SECS communications log records that are read are stored in the `_GEM_CommLog[]` system-defined variable.

The most recent SECS communications log record is stored in `_GEM_CommLog[0]`. Other records are stored in chronological order in `_GEM_CommLog[1]` and on.

The number of SECS communications log records that are read is stored in the `_GEM_CommLogCnt` system-defined variable.

## Related System-defined Variables

Name	Meaning	Data type	Description
<code>_GEM_CommLogCnt</code>	SECS Communications Log Count	UINT	Gives the number of SECS communications log records that were gotten.
<code>_GEM_CommLog</code>	SECS Communications Log	ARRAY[0..99] OF <code>_sGEM_CommLog</code>	Stores the SECS communications log records.
<code>_GEM_ServiceStatus</code>	GEM Service Status	<code>_sGEM_SERVICE_STATUS</code>	Gives the GEM Service status. Refer to P. A-212 for details.

## Related Error Codes

Error code	Name	Description
16#041D	Exceeded Simultaneous Instruction Executed Resources	The number of simultaneously executed GEM instructions exceeded the limit.

Error code	Name	Description
16#3810	GEM Service Status in Initializing	The instruction was executed when the GEM Service status was Initializing.
16#3811	GEM Service Status in EQStarting	The instruction was executed when the GEM Service status was EQStarting.
16#3814	GEM Service Status in Stop	The instruction was executed when the GEM Service status was Stop.
16#3815	GEM Service Status in Error	The instruction was executed when the GEM Service status was Error.
16#3816	GEM Service Status in ShuttingDown	The instruction was executed when the GEM Service status was ShuttingDown.
16#3817	GEM Service Status in Shutdown	The instruction was executed when the GEM Service status was Shutdown.

### Precautions for Correct Use

- Check `_GEM_ServiceStatus` before you execute this instruction. If you execute this instruction when `_GEM_ServiceStatus` is not EQInitializing or EQRun, an error will occur and *Error* will change to TRUE.

### Sample Programming

This sample gets the SECS communications log.

If the GEM Service status is EQInitializing or EQRun and the *GetCommLog\_Start* internal variable changes from FALSE to TRUE, the SECS communications log is obtained.

## LD

Internal Variables	Variable	Data type	Initial value	Comment
	GetCommLog_Start	BOOL	FALSE	Flag to start getting the SECS communications log
	GetCommLog_instance	GEM_GetCommLog		Instance of GEM_GetCommLog instruction

External Variables	Variable	Comment
	<code>_GEM_ServiceStatus</code>	GEM Service status

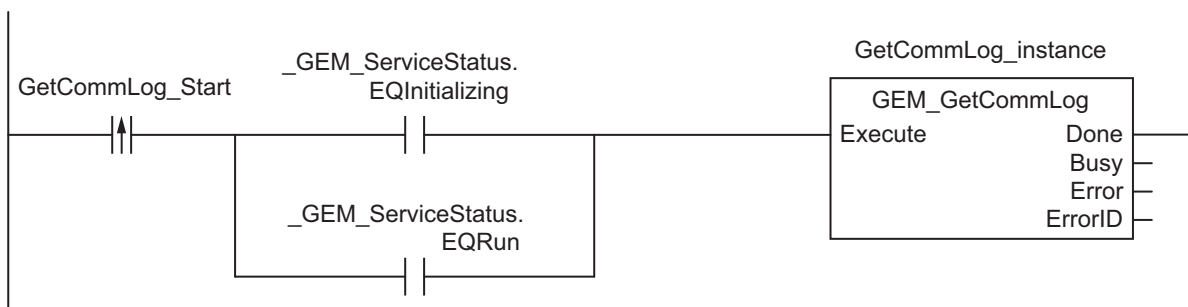



# ST

Internal Variables	Variable	Data type	Initial value	Comment
	GetCommLog_Start	BOOL	FALSE	Flag to start getting the SECS communications log
	R_TRIG_instance	R_TRIG		Instance of R_TRIG instruction
	Trigger	BOOL	FALSE	Flag for FALSE to TRUE change in <i>GetCommLog_Start</i>
	GetCommLog_instance	GEM_GetCommLog		Instance of GEM_GetCommLog instruction
	Stage	INT	0	Program execution status

External Variables	Variable	Comment
	<u>_GEM_ServiceStatus</u>	GEM Service status

```

CASE Stage Of
0:
  R_TRIG_instance( GetCommLog_Start, Trigger );
  IF( ( Trigger = TRUE )
      AND ( (_GEM_ServiceStatus.EQInitializing = TRUE) OR (_GEM_ServiceStatus.EQRun
= TRUE) )) THEN
    // Initialization
    GetCommLog_instance( Execute:=FALSE );
    Stage := 1;
  END_IF;
1: // Start send.
  GetCommLog_instance( Execute:=TRUE );
  IF( GetCommLog_instance.Done = TRUE ) THEN
    Stage := 10;
  ELSIF( GetCommLog_instance.Error = TRUE ) THEN
    // Add error processing as required.
    Stage := 10;
  END_IF;
10: // End
  Stage := 0;
END_CASE;
    
```

# GEM\_SetHSMSPParam

The GEM\_SetHSMSPParam instruction sets HSMS communications.

Instruction	Name	FB/ FUN	Graphic expression	ST expression
GEM_SetHSMSPParam	Set HSMS Communications Parameters	FB		GEM_SetHSMSPParam_instance( Execute, HSMSPParam, Done, Busy, Error, ErrorID);

## Variables

Name	Meaning	I/O	Description	Valid range	Unit	Default
HSMSPParam	HSMS communications parameters	Input	HSMS communications parameters	---	---	*1

\*1. If you omit an input parameter, the default value is not applied. A building error will occur.

	Boolean	Bit strings				Integers							Real numbers		Times, durations, dates, and text strings					
	BOOL	BYTE	WORD	DWORD	LWORD	USINT	UINT	UDINT	ULINT	SINT	INT	DINT	LINT	REAL	LREAL	TIME	DATE	TOD	DT	STRING
HSMSPParam	Refer to <i>Function</i> for details on the structure <code>_GEM_HSMS_PARAM</code> .																			

## Function

The GEM\_SetHSMSPParam instruction sets up HSMS communications with the host according to the specification with *HSMSPParam*.

If execution of this instruction ends normally, the set HSMS communications parameters are saved in non-volatile memory and stored in the controller.

The set HSMS communications parameters are not applied immediately. They are applied when execution of the GEM\_ControlService instruction in which Start Equipment is specified for *Cmd* ends normally.

The data type of *HSMSPParam* is structure `_sGEM_HSMS_PARAM`. The meanings of the members are as follows:

Variable Member	Meaning	Description	Data type	Valid range	Unit	Default
	HSMSPParam	HSMS Communications Parameters	HSMS communications settings	<code>_sGEM_HSMS_PARAM</code>	---	---

Variable Member	Meaning	Description	Data type	Valid range	Unit	Default
ConnectMode	TCP/IP Connection Mode	TCP/IP connection mode	_eGEM_ CONNECT	_GEM_CONNECT_PASSIVE(0):Passive _GEM_CONNECT_ACTIVE(1):Active	---	---
PassiveIPSel	IP Address Connection Restriction Flag	Connectable IP address restriction* <sup>1</sup> FALSE: No restriction. TRUE: Connection is possible only with the IP address set in <i>IpAdr</i> .	BOOL	Depends on data type.	---	---
IpAdr	IP Address	IP address of host	STRING[256]	---	---	---
PortNo	Port Number	Active Mode TCP/IP Connection: Host port number Passive Mode TCP/IP Connection: Standby port number for GEM Service	UINT	1 to 65,535	---	---
DeviceID	Device ID	ID that identifies the HSMS message	UINT	0 to 32,767	---	---
T3	Reply Timeout Time	Maximum time to wait for a response message in HSMS message communications	USINT	1 to 120	s	---
T5	Connection Separation Timeout Time	Interval to resend Select Requests when a selection response is not received to a sent Select Request	USINT	1 to 240	s	---
T6	Control Timeout Time	Maximum time to wait for a response message in HSMS message communications	USINT	1 to 240	s	---
T7	Connection Idle Timeout Time	Maximum time to wait for a Select Request* <sup>1</sup>	USINT	1 to 240	s	---
T8	Network Inter-character Timeout Time	Time to monitor for HSMS messages sent in multi-packets	USINT	1 to 120	s	---
Conversation-Timeout	Conversation Timeout Time	Maximum time to wait for a reply after sending a message	USINT	1 to 240	s	---

\*1. These settings are valid for a Passive Mode TCP/IP connection.

## Related System-defined Variables

Name	Meaning	Data type	Description
_GEM_HSMSPParam	HSMS Communications Parameters	sGEM_HS MS_PARA M	Gives the active HSMS communications settings. Refer to P. A-216 for details.
_GEM_ServiceStatus	GEM Service Status	_sGEM_ - SER- VICE_STAT US	Gives the GEM Service status. Refer to P. A-212 for details.

## Related Error Codes

Error code	Name	Description
16#3828	HSMS Communications Setting Out of Range	A value specified in <i>HSMSParam</i> is outside of the valid range.
16#041D	Exceeded Simultaneous Instruction Executed Resources	The number of simultaneously executed GEM instructions exceeded the limit.
16#3810	GEM Service Status in Initializing	The instruction was executed when the GEM Service status was Initializing.
16#3811	GEM Service Status in EQStarting	The instruction was executed when the GEM Service status was EQStarting.
16#3814	GEM Service Status in Stop	The instruction was executed when the GEM Service status was Stop.
16#3815	GEM Service Status in Error	The instruction was executed when the GEM Service status was Error.
16#3816	GEM Service Status in ShuttingDown	The instruction was executed when the GEM Service status was ShuttingDown.
16#3817	GEM Service Status in Shutdown	The instruction was executed when the GEM Service status was Shutdown.

## Precautions for Correct Use

- Check *\_GEM\_ServiceStatus* before you execute this instruction. If you execute this instruction when *\_GEM\_ServiceStatus* is not EQInitializing or EQRun, an error will occur and *Error* will change to TRUE.

## Sample Programming

This sample sets T3 (reply timeout time) in the HSMS communications settings to 100 s.

If the GEM Service status is EQInitializing or EQRun and the *SetHSMSParam\_Start* internal variable changes from FALSE to TRUE, setting the HSMS communications is started.

**LD**

Internal Variables	Variable	Data type	Initial value	Comment
	SetHSMSPParam_Start	BOOL	FALSE	Flag to start setting HSMS communications setting T3
	varHSMSPParam	_sGEM_HSMS_PARAM		HSMS communications setting to change
	SetHSMSPParam_instance	GEM_SetHSMSParam		Instance of GEM_SetHSMSPParam instruction

External Variables	Variable	Comment
	_GEM_ServiceStatus	GEM Service status
	_GEM_HSMSPParam	HSMS Communications Parameters

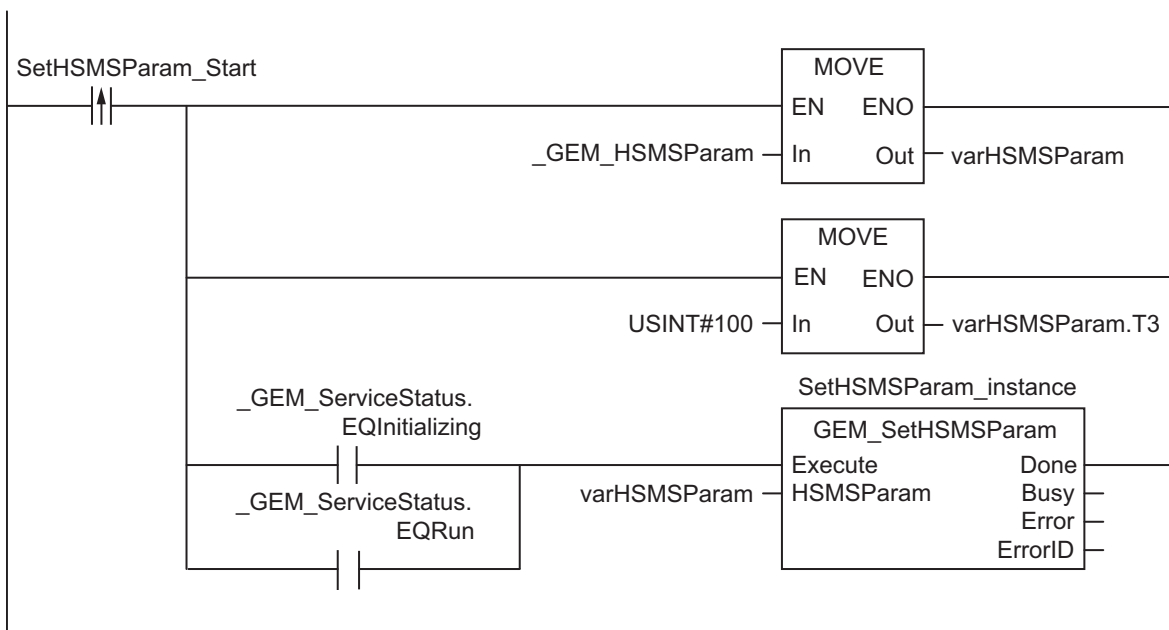

**ST**

Internal Variables	Variable	Data type	Initial value	Comment
	SetHSMSParam_Start	BOOL	FALSE	Flag to start setting HSMS communications setting T3
	R_TRIG_instance	R_TRIG		Instance of R_TRIG instruction
	Trigger	BOOL	FALSE	Flag for FALSE to TRUE change in <i>SetHSMSParam_Start</i>
	SetHSMSParam_instance	GEM_Set HSMSParam		Instance of GEM_SetHSMSParam instruction
	varHSMSParam	_sGEM_HSMS_PARAM		HSMS communications setting to change
	Stage	INT	0	Program execution status

External Variables	Variable	Comment
	_GEM_ServiceStatus	GEM Service status
	_GEM_HSMSParam	HSMS Communications Parameters

```

CASE Stage Of
0:
  R_TRIG_instance( SetHSMSParam_Start, Trigger );
  IF( ( Trigger = TRUE )
    AND ( ( _GEM_ServiceStatus.EQInitializing = TRUE ) OR ( _GEM_ServiceSta-
tus.EQRun = TRUE )) ) THEN
    // Initialization
    varHSMSParam := _GEM_HSMSParam;
    varHSMSParam.T3:= 100;
    SetHSMSParam_instance( Execute:=FALSE, HSMSParam:=varHSMSParam );
    Stage := 1;
  END_IF;
1:
  // Start send.
  SetHSMSParam_instance( Execute:=TRUE, HSMSParam:=varHSMSParam );
  IF( SetHSMSParam_instance.Done = TRUE ) THEN
    Stage := 10;
  ELSIF( SetHSMSParam_instance.Error = TRUE ) THEN
    // Add error processing as required.
    Stage := 10;
  END_IF;
10: // End
  Stage := 0;
END_CASE;

```

# GEM\_ChangeCommState

The GEM\_ChangeCommState instruction changes the equipment communications state to the specified state. The communications states are defined in the communications state model.

Instruction	Name	FB/ FUN	Graphic expression	ST expression
GEM_ChangeCommState	Change Communications State	FB		GEM_ChangeCommState_instance( Execute, TransitionEvent, Done, Busy, Error, ErrorID);

## Variables

Name	Meaning	I/O	Description	Valid range	Unit	Default
Transition-Event	Transition request	Input	Requested communications state	_GEM_COMM_DISABLED, _GEM_COMM_ENABLED	---	_GEM_COMM_DISABLED

	Boolean	Bit strings				Integers						Real numbers		Times, durations, dates, and text strings						
	BOOL	BYTE	WORD	DWORD	LWORD	USINT	UINT	UDINT	ULINT	SINT	INT	DINT	LINT	REAL	LREAL	TIME	DATE	TOD	DT	STRING
Transition-Event	Refer to <i>Function</i> for the enumerators of the enumerated type _eGEM_COMM.																			

## Function

The GEM\_ChangeCommState instruction changes the equipment communications state to the state specified with transition request *TransitionEvent*. The communications states are defined in the communications state model.

The data type of *TransitionEvent* is enumerated type \_eGEM\_COMM. The communications state that is changed to for each enumerator is given in the following table.

Enumerator	New communications state
_GEM_COMM_DISABLED	DISABLED
_GEM_COMM_ENABLED	ENABLED

The communications state transition is started when the instruction ends normally. Use the *\_GEM\_CommunicationsState* system-defined variable to confirm when the communications state transition is completed.

## Additional Information

- This instruction uses the Equipment Attempts to Establish Communications scenario for the GEM Establish Communications capability.
- The SECS message exchange between the equipment and host is given below.  
However, a SECS message is sent from the equipment to the host only when `_GEM_COMM_ENABLED` is specified for the *TransitionEvent* input variable.

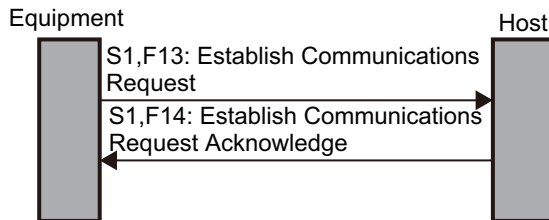

## Related System-defined Variables

Name	Meaning	Data type	Description
<code>_GEM_Communications State</code>	Communications State	<code>_sGEM_COMM_STATE</code>	Gives the state of the communications state model. Refer to P. A-218 for details.
<code>_GEM_ServiceStatus</code>	GEM Service Status	<code>_sGEM_SERVICE_STATUS</code>	Gives the GEM Service status. Refer to P. A-212 for details.

## Related Error Codes

Error code	Name	Description
16#0400	Input Value Out of Range	The value of <i>TransitionEvent</i> is outside of the valid range.
16#041D	Exceeded Simultaneous Instruction Executed Resources	The number of simultaneously executed GEM instructions exceeded the limit.
16#3810	GEM Service Status in Initializing	The instruction was executed when the GEM Service status was Initializing.
16#3811	GEM Service Status in EQStarting	The instruction was executed when the GEM Service status was EQStarting.
16#3812	GEM Service Status in EQInitializing	The instruction was executed when the GEM Service status was EQInitializing.
16#3814	GEM Service Status in Stop	The instruction was executed when the GEM Service status was Stop.
16#3815	GEM Service Status in Error	The instruction was executed when the GEM Service status was Error.
16#3816	GEM Service Status in ShuttingDown	The instruction was executed when the GEM Service status was ShuttingDown.
16#3817	GEM Service Status in Shutdown	The instruction was executed when the GEM Service status was Shutdown.
16#381A	State Transition in Progress	The instruction was executed when waiting for Establish Communications Request Acknowledge (S1,F14) from the host. This error will not occur when a reply timeout occurs.
16#381B	Insufficient Transaction Resource	When the instruction was executed, the limit to the number of transactions that can be buffered had been reached.



## Precautions for Correct Use

- Check *\_GEM\_ServiceStatus* before you execute this instruction. If you execute this instruction when *\_GEM\_ServiceStatus* is not EQRun, an error will occur and *Error* will change to TRUE.
- The instruction will end normally if the communications state requested with the *TransitionEvent* input variable is the same as the current communications state. The communications state will not change.
- If the instruction is executed when the communications state is NOT COMMUNICATING, an error will occur and *Error* will change to TRUE. However, if Establish Communications Request Acknowledge (S1,F14) is received or if a reply timeout occurs, the instruction will end normally. If the instruction ends in an error with an error code of 16#381A, wait for the reply timeout time and then execute the instruction again.

## Sample Programming

This sample changes the communications state to ENABLED or DISABLED. It also confirms that the communications state has changed.

If the GEM Service status is EQRun, the communications state is changed for the following changes.

- If the *Enabled\_Start* internal variable changes from FALSE to TRUE, the communications state is changed to ENABLED.
- If the *Disabled\_Start* internal variable changes from FALSE to TRUE, the communications state is changed to DISABLED.

## LD

Internal Variables	Variable	Data type	Initial value	Comment
	Enabled_Start	BOOL	FALSE	Flag to start changing the communications state to Enabled
	Disabled_Start	BOOL	FALSE	Flag to start changing the communications state to Disabled
	transitionEvent_Comm State	_eGEM_ COMM	_GEM_ COMM_ DISABLED	Event to request the change
	ChangeCommState_ instance	GEM_Change CommState		Instance of GEM_ChangeCommState instruction
	ChangeCommState_ WaitResp	BOOL	FALSE	Flag that indicates waiting for completion of state change
	ChangeCommState_ Complete	BOOL	FALSE	State change completion flag

External Variables	Variable	Comment
	_GEM_ServiceStatus	GEM Service status
	_GEM_Communications State	Communications state

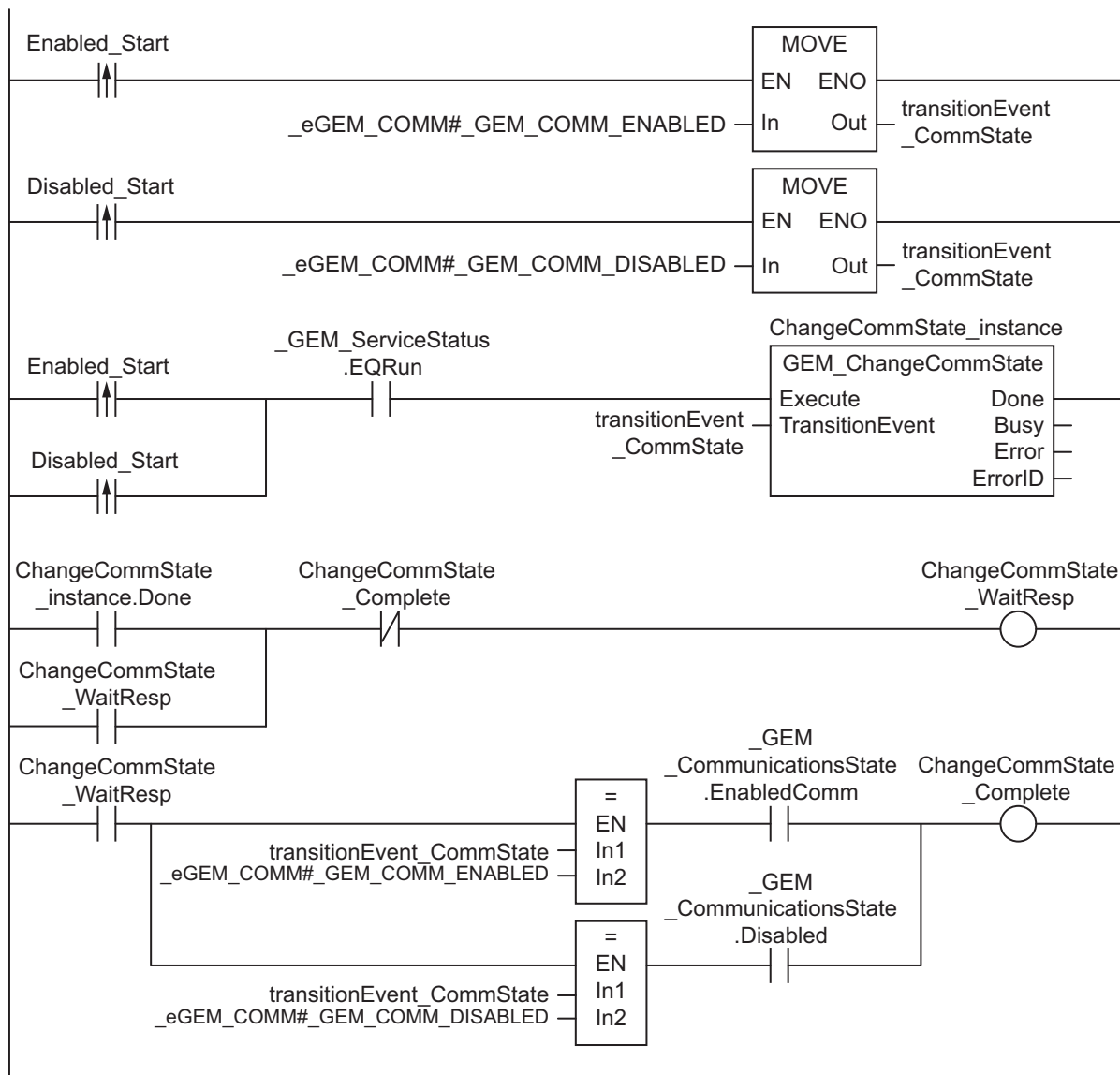

**ST**

Internal Variables	Variable	Data type	Initial value	Comment
	Enabled_Start	BOOL	FALSE	Flag to start changing the communications state to Enabled
	Disabled_Start	BOOL	FALSE	Flag to start changing the communications state to Disabled
	transitionEvent_Comm State	_eGEM_COMM	_GEM_COMM_DISABLED	Event to request the change
	ChangeCommState_instance	GEM_ChangeCommState		Instance of GEM_ChangeCommState instruction
	R_TRIG_Enabled_instance	R_TRIG		Instance of R_TRIG instruction for Enabled
	R_TRIG_Disabled_instance	R_TRIG		Instance of R_TRIG instruction for Disabled
	Trigger_Disabled	BOOL	FALSE	Flag for FALSE to TRUE change in <i>Enabled_Start</i>
	Trigger_Enabled	BOOL	FALSE	Flag for FALSE to TRUE change in <i>Disabled_Start</i>
	Stage	INT	0	Program execution status

External Variables	Variable	Comment
	_GEM_ServiceStatus	GEM Service status
	_GEM_Communications State	Communications state

CASE Stage Of

0:

```

R_TRIG_Enabled_instance( Enabled_Start, Trigger_Enabled );
R_TRIG_Disabled_instance( Disabled_Start, Trigger_Disabled );
IF( Trigger_Enabled = TRUE ) THEN
    transitionEvent_CommState := _eGEM_COMM#_GEM_COMM_ENABLED;
ELSIF( Trigger_Disabled = TRUE ) THEN
    transitionEvent_CommState := _eGEM_COMM#_GEM_COMM_DISABLED;
ELSE
    RETURN;
END_IF;
IF( _GEM_ServiceStatus.EQRun = TRUE ) THEN
    // Initialization
    ChangeCommState_instance( Execute:=FALSE, transitionEvent:=transition-
Event_CommState );
    Stage := 1;
END_IF;

```

1:

```

// Start state change.
ChangeCommState_instance( Execute:=TRUE, transitionEvent:= transitionEvent_CommState );
IF( ChangeCommState_instance.Done = TRUE ) THEN
    Stage := 2;
ELSIF( ChangeCommState_instance.Error = TRUE ) THEN
    // Add error processing as required.
    Stage := 10;
END_IF;

```

```
2: // Wait for state change.
  IF(( transitionEvent_CommState = _eGEM_COMM#_GEM_COMM_ENABLED)
    AND _GEM_CommunicationsState.EnabledComm = TRUE ) THEN
    Stage := 10;
  ELSIF(( transitionEvent_CommState = _eGEM_COMM#_GEM_COMM_DISABLED )
    AND _GEM_CommunicationsState.Disabled = TRUE ) THEN
    Stage := 10;
  END_IF;
10: // End
  Stage := 0;
END_CASE;
```

# GEM\_ChangeControlState

The GEM\_ChangeControlState instruction changes the equipment control state to the specified state and reports the event to the host. The control states are defined in the equipment control state model.

Instruction	Name	FB/ FUN	Graphic expression	ST expression
GEM_ChangeControlState	Change Control State	FB		GEM_ChangeCotrolState_instance(Execute, TransitionEvent, Done, Busy, Error, ErrorID);

## Variables

Name	Meaning	I/O	Description	Valid range	Unit	Default
Transition-Event	Transition request	Input	Requested control state	_GEM_CONTROL_OFFLINE, _GEM_CONTROL_ONLINE_LOCAL, _GEM_COMM_ENABLED	---	_GEM_CONTROL_OFFLINE

	Boolean	Bit strings				Integers							Real numbers		Times, durations, dates, and text strings					
	BOOL	BYTE	WORD	DWORD	LWORD	USINT	UINT	UDINT	ULINT	SINT	INT	DINT	LINT	REAL	LREAL	TIME	DATE	TOD	DT	STRING
Transition-Event	Refer to <i>Function</i> for the enumerators of the enumerated type _eGEM_CONTROL.																			

## Function

The GEM\_ChangeControlState instruction changes the equipment control state to the state specified with transition request *TransitionEvent*. The control states are defined in the equipment control state model. After the state is changed, the event is reported to the host.

The data type of *TransitionEvent* is enumerated type \_eGEM\_CONTROL.

The control state that is changed to for each enumerator is given in the following table.

Enumerator	New control state
_GEM_CONTROL_OFFLINE	OFF-LINE
_GEM_CONTROL_ONLINE_LOCAL	ON-LINE/LOCAL
_GEM_CONTROL_ONLINE_REMOTE	ON-LINE/REMOTE

The specified control state transition is started when the instruction ends normally. Use the *\_GEM\_ControlState* system-defined variable to confirm when the control state transition is completed.

## Additional Information

- The SECS message exchange between the equipment and host is given below.

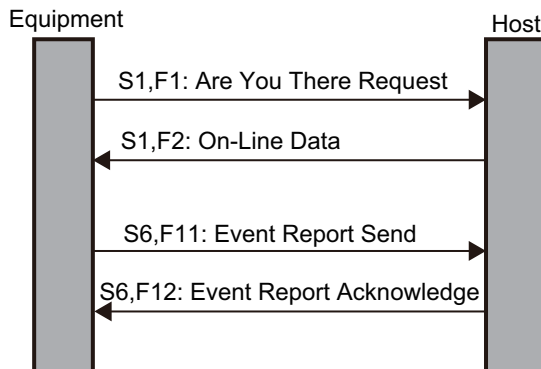

The Are You There Request (S1,F1) SECS message is sent to the host when this instruction is executed under the following two conditions.

- The control status must be EQUIPMENT OFF-LINE.
- ON-LINE/LOCAL or ON-LINE/REMOTE must be specified with *TransitionEvent*.

## Related System-defined Variables

Name	Meaning	Data type	Description
_GEM_ControlState	Control State	_sGEM_- CON- TROL_STA TE	Gives the state of the control state model. Refer to P. A-218 for details.
_GEM_ServiceStatus	GEM Service Status	_sGEM_- SER- VICE_STAT US	Gives the GEM Service status. Refer to P. A-212 for details.

## Related Error Codes

Error code	Name	Description
16#0400	Input Value Out of Range	The value of <i>TransitionEvent</i> is outside of the valid range.
16#041D	Exceeded Simultaneous Instruction Executed Resources	The number of simultaneously executed GEM instructions exceeded the limit.
16#3810	GEM Service Status in Initializing	The instruction was executed when the GEM Service status was Initializing.
16#3811	GEM Service Status in EQStarting	The instruction was executed when the GEM Service status was EQStarting.
16#3812	GEM Service Status in EQInitializing	The instruction was executed when the GEM Service status was EQInitializing.
16#3814	GEM Service Status in Stop	The instruction was executed when the GEM Service status was Stop.
16#3815	GEM Service Status in Error	The instruction was executed when the GEM Service status was Error.
16#3816	GEM Service Status in ShuttingDown	The instruction was executed when the GEM Service status was ShuttingDown.
16#3817	GEM Service Status in Shutdown	The instruction was executed when the GEM Service status was Shutdown.

Error code	Name	Description
16#381A	State Transition in Progress	The instruction was executed when waiting for On-Line Data (S1,F2) from the host. This error will not occur when a reply timeout occurs.
16#381B	Insufficient Transaction Resource	When the instruction was executed, the limit to the number of transactions that can be buffered had been reached.

### Precautions for Correct Use

- Check `_GEM_ServiceStatus` before you execute this instruction. If you execute this instruction when `_GEM_ServiceStatus` is not EQRun, an error will occur and `Error` will change to TRUE.
- The instruction will end normally if the control state requested with the `TransitionEvent` input variable is the same as the current control state. The control state will not change.
- The instruction will end in an error if it is executed when the control state is ATTEMPT ONLINE. However, if On-Line Data (S1,F2) is received or if a reply timeout occurs, the instruction will end normally. If the instruction ends in an error with an error code of 16#381A, wait for the reply timeout time and then execute the instruction again.

### Sample Programming

This sample changes the control state to LOCAL, REMOTE, or OFF-LINE. It also confirms that the control state has changed.

If the GEM Service status is EQRun, the control state is changed for the following changes.

- If the `Online_Local_Start` internal variable changes from FALSE to TRUE, the control state is changed to LOCAL.
- If the `Online_Remote_Start` internal variable changes from FALSE to TRUE, the control state is changed to REMOTE.
- If the `Offline_Start` internal variable changes from FALSE to TRUE, the control state is changed to OFF-LINE.

## LD

Internal Variables	Variable	Data type	Initial value	Comment
	Online_Local_Start	BOOL	FALSE	Flag to start changing the control state to LOCAL
	Online_Remote_Start	BOOL	FALSE	Flag to start changing the control state to REMOTE
	Offline_Start	BOOL	FALSE	Flag to start changing the control state to OFF-LINE
	transitionEvent_Control State	_eGEM_CONTROL	_GEM_CONTROL_OF-FLINE	Event to request the change
	ChangeControlState_instance	GEM_ChangeControlState		Instance of GEM_ChangeControlState instruction
	ChangeControlState_WaitResp	BOOL	FALSE	Flag that indicates waiting for completion of state change
	ChangeControlState_Complete	BOOL	FALSE	State change completion flag





**ST**

Internal Variables	Variable	Data type	Initial value	Comment
	Online_Local_Start	BOOL	FALSE	Flag to start changing the control state to LOCAL
	Online_Remote_Start	BOOL	FALSE	Flag to start changing the control state to REMOTE
	Offline_Start	BOOL	FALSE	Flag to start changing the control state to OFF-LINE
	transitionEvent_Control State	_eGEM_CONTROL	_GEM_CONTROL_OFFLINE	Event to request the change
	ChangeControlState_instance	GEM_ChangeControlState		Instance of GEM_ChangeControlState instruction
	R_TRIG_Local_instance	R_TRIG		Instance of R_TRIG instruction for Online_Local
	R_TRIG_Remote_instance	R_TRIG		Instance of R_TRIG instruction for Online_Remote
	R_TRIG_Offline_instance	R_TRIG		Instance of R_TRIG instruction for Offline
	Trigger_Local	BOOL	FALSE	Flag for FALSE to TRUE change in <i>Online_Local_Start</i>
	Trigger_Remote	BOOL	FALSE	Flag for FALSE to TRUE change in <i>Online_Remote_Start</i>
	Trigger_Offline	BOOL	FALSE	Flag for FALSE to TRUE change in <i>Offline_Start</i>
	Stage	INT	0	Program execution status

External Variables	Variable	Comment
	_GEM_ServiceStatus	GEM Service status
	_GEM_ControlState	Control state

```

CASE Stage Of
0: // Start
  R_TRIG_Local_instance( Online_Local_Start, Trigger_Local );
  R_TRIG_Remote_instance( Online_Remote_Start, Trigger_Remote );
  R_TRIG_Offline_instance( Offline_Start, Trigger_Offline );
  IF( Trigger_Local = TRUE ) THEN
    transitionEvent_ControlState := _eGEM_CONTROL#_GEM_CONTROL_ONLINE_LOCAL;
  ELSIF( Trigger_Remote = TRUE ) THEN
    transitionEvent_ControlState := _eGEM_CONTROL#_GEM_CONTROL_ONLINE_REMOTE;
  ELSIF( Trigger_Offline = TRUE ) THEN
    transitionEvent_ControlState := _eGEM_CONTROL#_GEM_CONTROL_OFFLINE;
  ELSE
    RETURN;
  END_IF;
  IF ( _GEM_ServiceStatus.EQRun = TRUE ) THEN
    // Initialization
    ChangeControlState_instance( Execute:=FALSE, transitionEvent:=transition-
Event_ControlState );
    Stage := 1;
  END_IF;

```

```

1: // Start state change.
   ChangeControlState_instance( Execute:=TRUE, transitionEvent:= transitionEvent_
ControlState );
   IF( ChangeControlState_instance.Done = TRUE ) THEN
       Stage := 2;
   ELSIF( ChangeControlState_instance.Error = TRUE ) THEN
       // Add error processing as required.
       Stage := 10;
   END_IF;
2: // Wait for state change.
   IF( (transitionEvent_ControlState = _eGEM_CONTROL#_GEM_CONTROL_ONLINE_LOCAL )
       AND _GEM_ControlState.OnlineLocal = TRUE ) THEN
       Stage := 10;
   ELSIF( (transitionEvent_ControlState = _eGEM_CONTROL#_GEM_CONTROL_ONLINE_REMOTE
)
       AND _GEM_ControlState.OnlineRemote = TRUE ) THEN
       Stage := 10;
   ELSIF( (transitionEvent_ControlState = _eGEM_CONTROL#_GEM_CONTROL_OFFLINE )
       AND _GEM_ControlState.EquipOffline = TRUE ) THEN
       Stage := 10;
   END_IF;
10: // End
   Stage := 0;
END_CASE;

```

# GEM\_InitEvent

The GEM\_InitEvent instruction initializes event information.

Instruction	Name	FB/ FUN	Graphic expression	ST expression
GEM_InitEvent	Initialize Events	FB		GEM_InitEvent_instance( Execute, Done, Busy, Error, ErrorID);

## Variables

Only common variables are used.

## Function

The GEM\_InitEvent instruction initializes event information. The event information returns to the values that were set on the SECS/GEM Configurator.

## Additional Information

- Events can be dynamically added from the host for acceptance tests. Execute this instruction to initialize these events without using the SECS/GEM Configurator.

## Related System-defined Variables

Name	Meaning	Data type	Description
_GEM_ServiceStatus	GEM Service Status	_sGEM_- SER- VICE_STAT US	Gives the GEM Service status. Refer to P. A-212 for details.

## Related Error Codes

Error code	Name	Description
16#041D	Exceeded Simultaneous Instruction Executed Resources	The number of simultaneously executed GEM instructions exceeded the limit.
16#3810	GEM Service Status in Initializing	The instruction was executed when the GEM Service status was Initializing.
16#3811	GEM Service Status in EQStarting	The instruction was executed when the GEM Service status was EQStarting.

Error code	Name	Description
16#3813	GEM Service Status in EQRun	The instruction was executed when the GEM Service status was EQRun.
16#3814	GEM Service Status in Stop	The instruction was executed when the GEM Service status was Stop.
16#3815	GEM Service Status in Error	The instruction was executed when the GEM Service status was Error.
16#3816	GEM Service Status in ShuttingDown	The instruction was executed when the GEM Service status was ShuttingDown.
16#3817	GEM Service Status in Shutdown	The instruction was executed when the GEM Service status was Shutdown.

### Precautions for Correct Use

- Check `_GEM_ServiceStatus` before you execute this instruction. If you execute this instruction when `_GEM_ServiceStatus` is not EQInitializing, an error will occur and `Error` will change to TRUE.

### Sample Programming

This sample initializes the event information.

If the GEM Service status is EQInitializing and the `InitEvent_Start` internal variable changes from FALSE to TRUE, the event information is initialized.

## LD

Internal Variables	Variable	Data type	Initial value	Comment
	InitEvent_Start	BOOL	FALSE	Flag to start initialization of events in GEM Services
	InitEvent_instance	GEM_InitEvent		Instance of GEM_InitEvent instruction

External Variables	Variable	Comment
	<code>_GEM_ServiceStatus</code>	GEM Service status

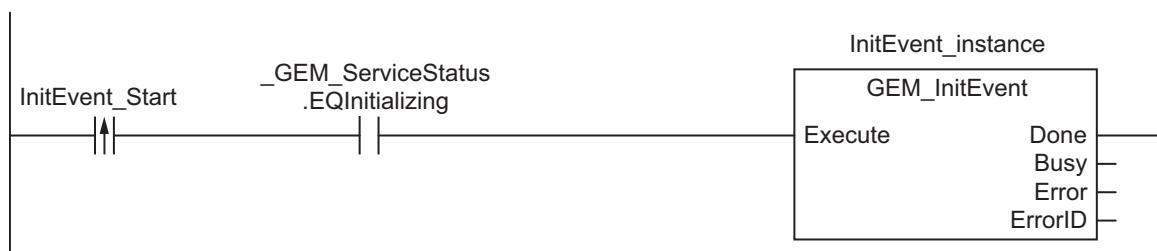

## ST

Internal Variables	Variable	Data type	Initial value	Comment
	InitEvent_Start	BOOL	FALSE	Flag to start initialization of events in GEM Services
	R_TRIG_instance	R_TRIG		Instance of R_TRIG instruction
	Trigger	BOOL	FALSE	Flag for FALSE to TRUE change in <i>InitEvent_Start</i>
	InitEvent_instance	GEM_InitEvent		Instance of GEM_InitEvent instruction
	Stage	INT	0	Program execution status

External Variables	Variable	Comment
	<u>_GEM_ServiceStatus</u>	GEM Service status

```

CASE Stage Of
0:
  R_TRIG_instance( InitEvent_Start, Trigger );
  IF( ( Trigger = TRUE )
      AND ( _GEM_ServiceStatus.EQInitializing = TRUE )) THEN
    // Initialization
    InitEvent_instance( Execute:=FALSE );
    Stage := 1;
  END_IF;
1: // Start send.
  InitEvent_instance( Execute:=TRUE );
  IF( InitEvent_instance.Done = TRUE ) THEN
    Stage := 10;
  ELSIF( InitEvent_instance.Error = TRUE ) THEN
    // Add error processing as required.
    Stage := 10;
  END_IF;
10: // End
  Stage := 0;
END_CASE;

```

# GEM\_ReportEvent

The GEM\_ReportEvent instruction reports events to the host.

Instruction	Name	FB/ FUN	Graphic expression	ST expression
GEM_ReportEvent	Report Event	FB		GEM_ReportEvent_instance( Execute, CEID, Done, Busy, Error, ErrorID);

## Variables

Name	Meaning	I/O	Description	Valid range	Unit	Default
CEID	Event ID	Input	Event ID to report to host	Depends on data type.	---	*1

\*1. If you omit the input parameter, the default value is not applied. A building error will occur.

	Boolean	Bit strings				Integers						Real numbers		Times, durations, dates, and text strings						
	BOOL	BYTE	WORD	DWORD	LWORD	USINT	UINT	UDINT	ULINT	SINT	INT	DINT	LINT	REAL	LREAL	TIME	DATE	TOD	DT	STRING
CEID						OK	OK	OK	OK											

## Function

The GEM\_ReportEvent instruction reports the event specified with *CEID* to the host.

## Additional Information

- This instruction uses the Collection Event Occurs on Equipment scenario for the GEM Event Notification capability.
- The SECS message exchange between the equipment and host is given below.

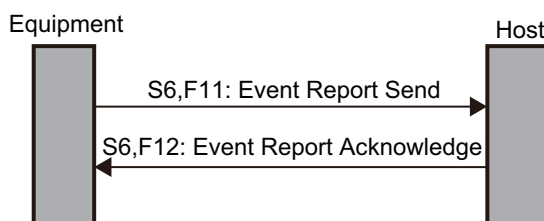

## Related System-defined Variables

Name	Meaning	Data type	Description
<code>_GEM_ServiceStatus</code>	GEM Service Status	<code>_sGEM_-SER-VICE_STAT US</code>	Gives the GEM Service status. Refer to P. A-212 for details.

## Related Error Codes

Error code	Name	Description
16#0419	Incorrect Data Type	The data type specified for <i>CEID</i> was not USINT, UINT, UDINT, or ULINT.
16#041D	Exceeded Simultaneous Instruction Executed Resources	The number of simultaneously executed GEM instructions exceeded the limit.
16#3824	Undefined CEID	A CEID that was not registered on the SECS/GEM Configurator was specified.
16#3810	GEM Service Status in Initializing	The instruction was executed when the GEM Service status was Initializing.
16#3811	GEM Service Status in EQStarting	The instruction was executed when the GEM Service status was EQStarting.
16#3812	GEM Service Status in EQInitializing	The instruction was executed when the GEM Service status was EQInitializing.
16#3814	GEM Service Status in Stop	The instruction was executed when the GEM Service status was Stop.
16#3815	GEM Service Status in Error	The instruction was executed when the GEM Service status was Error.
16#3816	GEM Service Status in ShuttingDown	The instruction was executed when the GEM Service status was ShuttingDown.
16#3817	GEM Service Status in Shutdown	The instruction was executed when the GEM Service status was Shutdown.
16#381B	Insufficient Transaction Resource	When the instruction was executed, the limit to the number of transactions that can be buffered had been reached.

## Precautions for Correct Use

- Check `_GEM_ServiceStatus` before you execute this instruction. If you execute this instruction when `_GEM_ServiceStatus` is not EQRun, an error will occur and *Error* will change to TRUE.
- In the following cases, the instruction ends normally and no event is reported to the host.
  - a) The instruction was executed when the communications state was not COMMUNICATING and the control state was not ON-LINE/LOCAL or ON-LINE/REMOTE.
  - b) A CEID that was disabled on the SECS/GEM Configurator was specified by the *CEID* input variable and the instruction was executed.

## Sample Programming

This sample reports a CEID = 1 event to the host.



If the GEM Service status is EQRun and the *ReportEvent\_Start* internal variable changes from FALSE to TRUE, event notification is sent.

## LD

Internal Variables	Variable	Data type	Initial value	Comment
	ReportEvent_Start	BOOL	FALSE	Flag to start event notification
	ReportEvent_instance	GEM_Report Event		Instance of GEM_ReportEvent instruction
	DEIDValue	UINT	0	Value of <i>CEID</i>

External Variables	Variable	Comment
	_GEM_ServiceStatus	GEM Service status

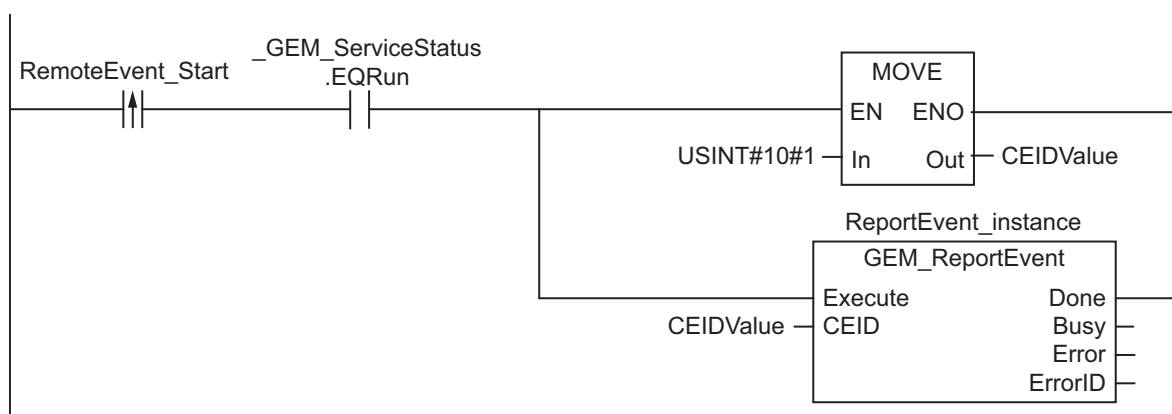

# ST

Internal Variables	Variable	Data type	Initial value	Comment
	ReportEvent_Start	BOOL	FALSE	Flag to start event notification
	R_TRIG_instance	R_TRIG		Instance of R_TRIG instruction
	CEIDValue	UINT	0	Value of <i>CEID</i>
	Trigger	BOOL	FALSE	Flag for FALSE to TRUE change in <i>ReportEvent_Start</i>
	ReportEvent_instance	GEM_Report Event		Instance of GEM_ReportEvent instruction
	Stage	INT	0	Program execution status

External Variables	Variable	Comment
	<u>_GEM_ServiceStatus</u>	GEM Service status

```

CASE Stage Of
0:
  R_TRIG_instance( ReportEvent_Start, Trigger );
  IF( ( Trigger = TRUE )
      AND ( _GEM_ServiceStatus.EQRun = TRUE ) ) THEN
    // Initialization
    CEIDValue := UINT#1;
    ReportEvent_instance( Execute:=FALSE, CEID:=CEIDValue );
    Stage := 1;
  END_IF;
1: // Start send.
  ReportEvent_instance( Execute:=TRUE, CEID:=CEIDValue );
  IF( ReportEvent_instance.Done = TRUE ) THEN
    Stage := 10;
  ELSIF( ReportEvent_instance.Error = TRUE ) THEN
    // Add error processing as required.
    Stage := 10;
  END_IF;
10: // End
  Stage := 0;
END_CASE;

```

# GEM\_ReportAlarm

The GEM\_ReportAlarm instruction reports alarms and events to the host.

Instruction	Name	FB/ FUN	Graphic expression	ST expression
GEM_ReportAlarm	Report Alarm	FB		GEM_ReportAlarm_instance( Execute, ALID, AlarmState, Done, Busy, Error, ErrorID);

## Variables

Name	Meaning	I/O	Description	Valid range	Unit	Default
ALID	Alarm ID	Input	Alarm number defined in alarm table	Depends on data type.		*1
AlarmState	Alarm state	Input	Alarm state to report	_GEM_ALARM_- CLEAR, _GEM_ALARM_- SET	---	_GEM_ALARM_- CLEAR

\*1. If you omit an input parameter, the default value is not applied. A building error will occur.

	Boolean	Bit strings				Integers							Real numbers		Times, durations, dates, and text strings					
	BOOL	BYTE	WORD	DWORD	LWORD	USINT	UINT	UDINT	ULINT	SINT	INT	DINT	LINT	REAL	LREAL	TIME	DATE	TOD	DT	STRING
ALID						OK	OK	OK	OK											
AlarmState	Refer to <i>Function</i> for the enumerators of the enumerated type _eGEM_ALARM_STATE.																			

## Function

The GEM\_ReportAlarm instruction reports the alarm state *AlarmState* with the specified alarm ID *ALID* to the host. The GEM\_ReportAlarm instruction reports the event to the host.

The data type of *AlarmState* is enumerated type \_eGEM\_ALARM\_STATE.

The meanings of the enumerators are as follows:

Enumerator	Meaning
_GEM_ALARM_CLEAR	The alarm was cleared.
_GEM_ALARM_SET	An alarm occurred.

## Additional Information

- This instruction uses the Send Alarm Report scenario of the GEM Alarm Management capability.
- The SECS message exchange between the equipment and host is given below.

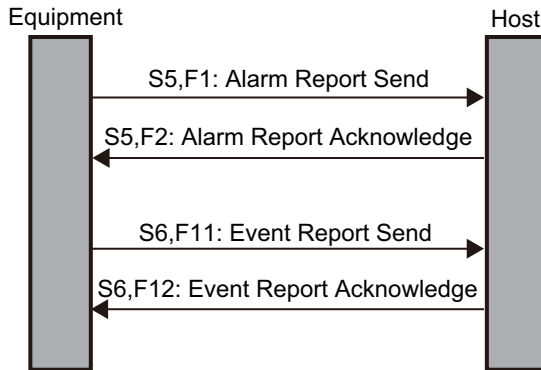

## Related System-defined Variables

Name	Meaning	Data type	Description
_GEM_ServiceStatus	GEM Service Status	_sGEM_- SER- VICE_STAT US	Gives the GEM Service status. Refer to P. A-212 for details.

## Related Error Codes

Error code	Name	Description
16#0419	Incorrect Data Type	The data type specified for <i>ALID</i> was not USINT, UINT, UDINT, or ULINT.
16#0400	Input Value Out of Range	The value of <i>AlarmState</i> is outside of the valid range.
16#041D	Exceeded Simultaneous Instruction Executed Resources	The number of simultaneously executed GEM instructions exceeded the limit.
16#3825	Undefined ALID	An ALID that was not registered on the SECS/GEM Configurator was specified.
16#3810	GEM Service Status in Initializing	The instruction was executed when the GEM Service status was Initializing.
16#3811	GEM Service Status in EQStarting	The instruction was executed when the GEM Service status was EQStarting.
16#3812	GEM Service Status in EQInitializing	The instruction was executed when the GEM Service status was EQInitializing.
16#3814	GEM Service Status in Stop	The instruction was executed when the GEM Service status was Stop.
16#3815	GEM Service Status in Error	The instruction was executed when the GEM Service status was Error.
16#3816	GEM Service Status in ShuttingDown	The instruction was executed when the GEM Service status was ShuttingDown.
16#3817	GEM Service Status in Shutdown	The instruction was executed when the GEM Service status was Shutdown.
16#381B	Insufficient Transaction Resource	When the instruction was executed, the limit to the number of transactions that can be buffered had been reached.

## Precautions for Correct Use

- Check `_GEM_ServiceStatus` before you execute this instruction. If you execute this instruction when `_GEM_ServiceStatus` is not EQRun, an error will occur and *Error* will change to TRUE.
- In the following cases, execution of this instruction ends normally, the alarm status is not reported to the host, and only the event is reported.
  - a) The *AlarmState* input variable specifies the same state as the current alarm state.
  - b) An ALID that was disabled in the SECS/GEM Configurator is specified for the *ALID* input variable.

## Sample Programming

This sample reports alarm ALID = 1 alarm status and event to the host.

If the GEM Service status is EQRun, each alarm status is reported for the following changes.

- If the *ReportAlarmSet\_Start* internal variable changes from FALSE to TRUE, notification that an alarm occurred is sent.
- If the *ReportAlarmClear\_Start* internal variable changes from FALSE to TRUE, notification that the alarm was cleared is sent.

## LD

Internal Variables	Variable	Data type	Initial value	Comment
	ReportAlarmSet_Start	BOOL	FALSE	Flag to start notification that an alarm occurred
	ReportAlarmClear_Start	BOOL	FALSE	Flag to start notification that the alarm was cleared
	ReportAlarm_instance	GEM_Report Alarm		Instance of GEM_ReportAlarm instruction
	AlarmStateValue	_eGEM_ALARM_STATE	_GEM_ALARM_CLEAR	Alarm information
	ALIDValue	UINT	0	ALID of alarm to report

External Variables	Variable	Comment
	_GEM_ServiceStatus	GEM Service status

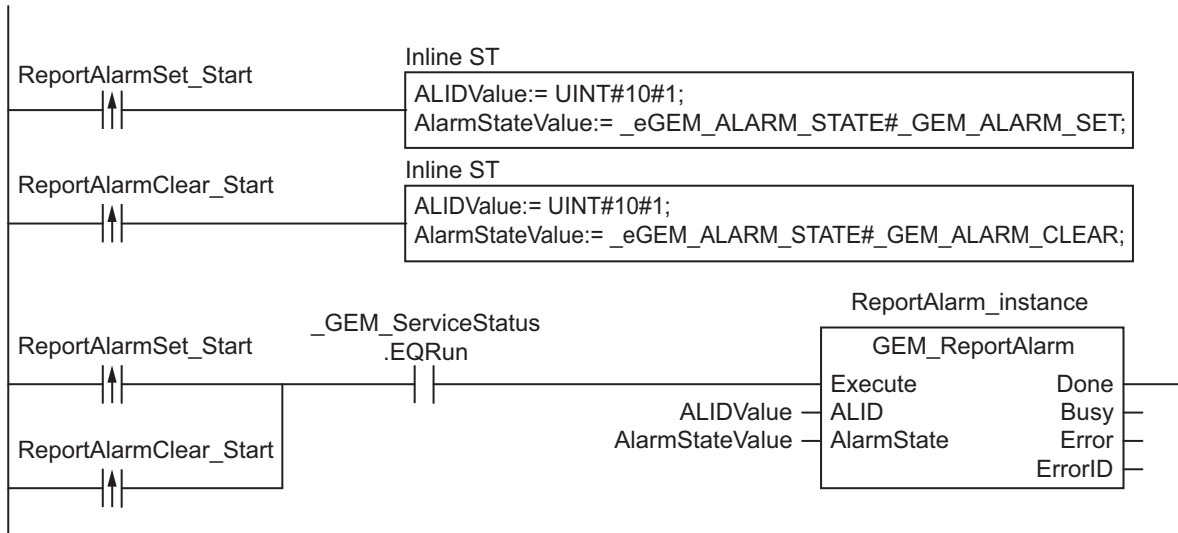

## ST

Internal Variables	Variable	Data type	Initial value	Comment
	ReportAlarmSet_Start	BOOL	FALSE	Flag to start notification that an alarm occurred
	ReportAlarmClear_Start	BOOL	FALSE	Flag to start notification that the alarm was cleared
	ALIDValue	UINT	0	ALID of alarm to report
	AlarmStateValue	_eGEM_ALARM_STATE	_GEM_ALARM_CLEAR	Alarm information
	R_TRIG_AlarmSet_instance	R_TRIG		Instance of R_TRIG instruction for AlarmSet
	R_TRIG_AlarmClear_instance	R_TRIG		Instance of R_TRIG instruction for AlarmClear
	Trigger_AlarmSet	BOOL	FALSE	Flag for FALSE to TRUE change in <i>ReportAlarmSet_Start</i>
	Trigger_AlarmClear	BOOL	FALSE	Flag for FALSE to TRUE change in <i>ReportAlarmClear_Start</i>
	ReportAlarm_instance	GEM_Report Alarm		Instance of GEM_ReportAlarm instruction
	Stage	INT	0	Program execution status

External Variables	Variable	Comment
	_GEM_ServiceStatus	GEM Service status

CASE Stage Of  
0:

```

R_TRIG_AlarmSet_instance( ReportAlarmSet_Start, Trigger_AlarmSet );
R_TRIG_AlarmClear_instance( ReportAlarmClear_Start, Trigger_AlarmClear );
IF( Trigger_AlarmSet = TRUE ) THEN
    AlarmStateValue := _eGEM_ALARM_STATE#_GEM_ALARM_SET;
ELSIF( Trigger_AlarmClear = TRUE ) THEN
    AlarmStateValue := _eGEM_ALARM_STATE#_GEM_ALARM_CLEAR;
ELSE

```

```

        RETURN;
    END_IF;
    IF( _GEM_ServiceStatus.EQRun = TRUE ) THEN
        // Initialization
        ReportAlarm_instance( Execute:=FALSE, ALID:=ALIDValue,AlarmState:=AlarmStateValue );
        Stage := 1;
    END_IF;
1: // Start send.
    ReportAlarm_instance( Execute:=TRUE, ALID:=ALIDValue,AlarmState:=AlarmStateValue );
    IF( ReportAlarm_instance.Done = TRUE ) THEN
        Stage := 10;
    ELSIF( ReportAlarm_instance.Error = TRUE ) THEN
        // Add error processing as required.
        Stage := 10;
    END_IF;
10: // End
    Stage := 0;
END_CASE;

```

# GEM\_AckHostCmd

The GEM\_AckHostCmd instruction sends the execution accept/reject result in reply to an execution request for a host command.

Instruction	Name	FB/ FUN	Graphic expression	ST expression
GEM_AckHost Cmd	Acknowledge Host Command	FB		GEM_AckHostCmd_instance( Execute, RCMD, HCACK, CPErrNum, Done, Busy, Error, ErrorID);

## Variables

Name	Meaning	I/O	Description	Valid range	Unit	Default
RCMD	Command name	Input	Received host command name*1	81 bytes max. (including final NULL)*2	---	---
HCACK	Host command parameter acknowledge code		Command accept/reject code 16#00: Acknowledged. Command was executed. 16#01: Command does not exist. 16#02: Cannot perform now. 16#03: At least one parameter is invalid. 16#04: Acknowledged. Command will be performed with completion signaled later. 16#05: Rejected. Already in desired condition. 16#06: No such object exists. 16#07 to 16#3F: Reserved.	16#00 to 16#3F		16#00
CPErr- Num	Number of command parameter errors		Number of command parameters deemed in error	Depends on data type.		0

\*1. It is not necessary to set an input variable. The PPID from the host command execution request is input automatically.

\*2. The maximum number of characters is set on the SECS/GEM Configurator. The maximum number of bytes is the maximum number of characters including the final NULL character plus 1.



	Bool- ean	Bit strings					Integers							Real num- bers		Times, durations, dates, and text strings				
	BOOL	BYTE	WORD	DWORD	LWORD	USINT	UINT	UDINT	ULINT	SINT	INT	DINT	LINT	REAL	LREAL	TIME	DATE	TOD	DT	STRING
RCMD																				OK
HCACK		OK																		
CPErrNum						OK	OK			OK	OK									

## Function

The GEM\_AckHostCmd instruction sends the execution accept/reject result in reply to an execution request for a host command from the host. The following are required for the reply.

- Host command parameter acknowledge code  
 The acknowledge tells whether the host command can be executed. The result is based on the following checks.
  - a) Is the host command valid?
  - b) Can the host command be executed?
- Number of host command parameter errors  
 This is the number of CPVAL values deemed in error in the host command.
- The following information on the CPVAL values that were deemed to be in error in the host command
  - a) CPNAME of each CPVAL value
  - b) Acknowledge codes of the CPVAL values that were deemed to be in error

Refer to the application procedure for this instruction for the processing to send a reply with the execution accept/reject result.

## Additional Information

- This instruction uses the Host Command scenario of the GEM Remote Control capability.
- A SECS message is sent if this instruction is executed and execution ends normally. The SECS message exchange between the equipment and host is given below.

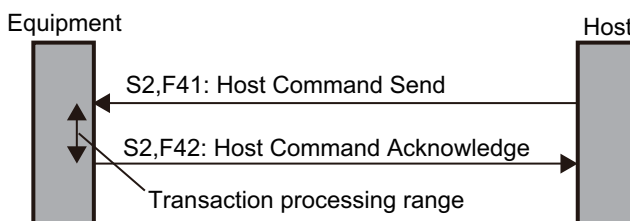

## Related System-defined Variables

Name	Meaning	Data type	Description
_GEM_BusyHostCmd	Host Command Transaction Processing Flag	BOOL	Gives the status of processing a transaction for a host command from the host. <sup>*1</sup> TRUE: Processing FALSE: Not processing.

Name	Meaning	Data type	Description
_GEM_InterlockHostCmd	Host Command Interlock	BOOL	Specifies whether to prohibit reception of host commands from the host. TRUE: Prohibited. FALSE: Granted
_GEM_ServiceStatus	GEM Service Status	_sGEM_ SER- VICE_STAT US	Gives the GEM Service status. Refer to P. A-212 for details.

\*1. This variable changes to TRUE when Host Command Send (S2,F41) is received. It will change to FALSE when execution of the instruction is completed normally.

## Related User-defined Variables

### ● Variables for Host Command Reception

Name	Description	SECS/GEM Configurator setting
S2,F41: RCMD	Stores the RCMD of the host command received from the host.	Host Command – Operation settings
S2,F41: Number of CPNAMEs	Stores the number of host command CPNAMEs received from the host.	
S2,F41: CPNAME Table	Stores the CPNAMEs of the host command received from the host.	
S2,F41: CPVAL	Stores the CPVAL of the host command CPNAME received from the host. There is a different variable for each CPNAME.	Host commands – Host command definition

### ● Variables for Host Command Send

Name	Description	SECS/GEM Configurator setting
S2,F42: Error CPNAME Table	Stores the CPNAMEs of the CPVALs that were deemed to be in error.	Host Command – Operation settings
S2,F42: CPACK Table	Stores the acknowledge codes of the CPVAL that were deemed to be in error. 16#01: Parameter name CPNAME does not exist. 16#02: Illegal value specified for CPVAL. 16#03: Illegal format specified for CPVAL. 16#04 to 16#3F: Other equipment-specific errors	

## Related Error Codes

Error code	Name	Description
16#3830	HACK Out of Range	The value of the HACK input variable is outside of the valid range.
16#041D	Exceeded Simultaneous Instruction Executed Resources	The number of simultaneously executed GEM instructions exceeded the limit.
16#3821	Invalid Size	The value specified in the CPErrNum input variable is larger than the number of array elements in S2,F42: Error CPNAME Table or S2,F42: CPACK Table.

Error code	Name	Description
16#382F	Illegal CPNAME	A CPNAME specified in <i>S2,F41: CPNAME Table</i> is different from a received CPNAME.
16#3831	CPACK Out of Range	The value in <i>S2,F42: CPACK Table</i> is outside of the valid range.
16#3810	GEM Service Status in Initializing	The instruction was executed when the GEM Service status was Initializing.
16#3811	GEM Service Status in EQStarting	The instruction was executed when the GEM Service status was EQStarting.
16#3812	GEM Service Status in EQInitializing	The instruction was executed when the GEM Service status was EQInitializing.
16#3814	GEM Service Status in Stop	The instruction was executed when the GEM Service status was Stop.
16#3815	GEM Service Status in Error	The instruction was executed when the GEM Service status was Error.
16#3816	GEM Service Status in ShuttingDown	The instruction was executed when the GEM Service status was ShuttingDown.
16#3817	GEM Service Status in Shutdown	The instruction was executed when the GEM Service status was Shutdown.
16#3818	No Message Received	The instruction was executed when a host command was not received.

## Precautions for Correct Use

- Before executing the instruction, confirm that all of the following conditions are met. If the instruction is executed when any of these conditions is not met, an error will occur and *Error* will change to TRUE.
  - a) *\_GEM\_ServiceStatus* must be *EQRun*.
  - b) *\_GEM\_BusyHostCmd* must be TRUE.
- In the following cases, *\_GEM\_BusyHostCmd* does not change to TRUE even if Host Command Send (*S2,F41*) is received.
  - a) The RCMD received in the host command does not exist in the receivable host commands set on the SECS/GEM Configurator.
  - b) The data type of RCMD, CPNAME, or CPVAL did not agree between the received host command and SECS/GEM Configurator setting.
  - c) The user-defined variable to store RCMD, CPNAME, or CPVA from the received host command does not exist.
  - d) *\_GEM\_Interlock\_HostCmd* is TRUE.
  - e) Host Command Send (*S2,F41*) is disabled in the message settings on the SECS/GEM Configurator.
- *S2,F41: CPVAL* is not updated if Omit Parameters is enabled on the SECS/GEM Configurator.
- Execution of the instruction will not end in an error even if the *RCMD* input variable specifies a command name that is different from the command name in *S2,F41: RCMD*.

## Application Procedure

Use the following procedure for this instruction.

### 1 Detecting Host Command Reception

Confirm that *\_GEM\_BusyHostCmd* changes from FALSE to TRUE.

Store the received host command in the following variables.

- S2,F41: RCMD
- S2,F41: Number of CPNAMEs
- S2,F41: CPNAME Table
- S2,F41: CPVAL

### 2 Determining the Validity of the Host Command and Storing Error Information

Determine if the host command is valid.

Examples of the criteria to determine validity are given below.

- Is the value of *S2,F41: CPVAL* correct?

If all of the CPVAL values meet the above criteria, the host command parameter acknowledge code is 16#00. If even one of the CPVAL values does not meet the above criteria, the host command parameter acknowledge code is 16#03. Store the error information for CPVAL values that do not meet the criteria as follows:

- Store the CPNAME of the CPVAL in *S2,F42: Error CPNAME Table*.
- Store the acknowledge code as the accept/reject result in *S2,F42: CPACK Table*.

### 3 Determining If the Host Command Can Be Executed

If the host command is valid, determine if the host command can be executed.

If it can be executed, the host command parameter acknowledge code is 16#00.

If it cannot be executed, the host command parameter acknowledge code is 16#02.

### 4 Executing Host Command

If the host command can be executed, execute it.

If host command execution completion will be reported as an event to the host after completion of the execution of this instruction, the host command parameter acknowledge code is 16#04.

If a response message will be sent as notification after completion of the execution of this instruction, the host command parameter acknowledge code is 16#00.

### 5 Sending the Host Command Execution Accept/Reject Result

Set the host command parameter acknowledge code from steps 2 to 4 for the *HCACK* input variable and execute the instruction. The host command execution accept/reject result is sent to the host.

The following diagram shows the user program processing and data flow for the application procedure. This diagram shows an example in which the host command START that was received from the host contains an invalid parameter. The CPNAME parameter in the host command START contains the following data.

- PPID
- LOTID
- MID

CPNAME is determined to be an invalid parameter because the CPVAL values for LOTID and MID are outside of the valid ranges. Numbers 1 to 5 in the diagram indicate the steps in the application procedure.

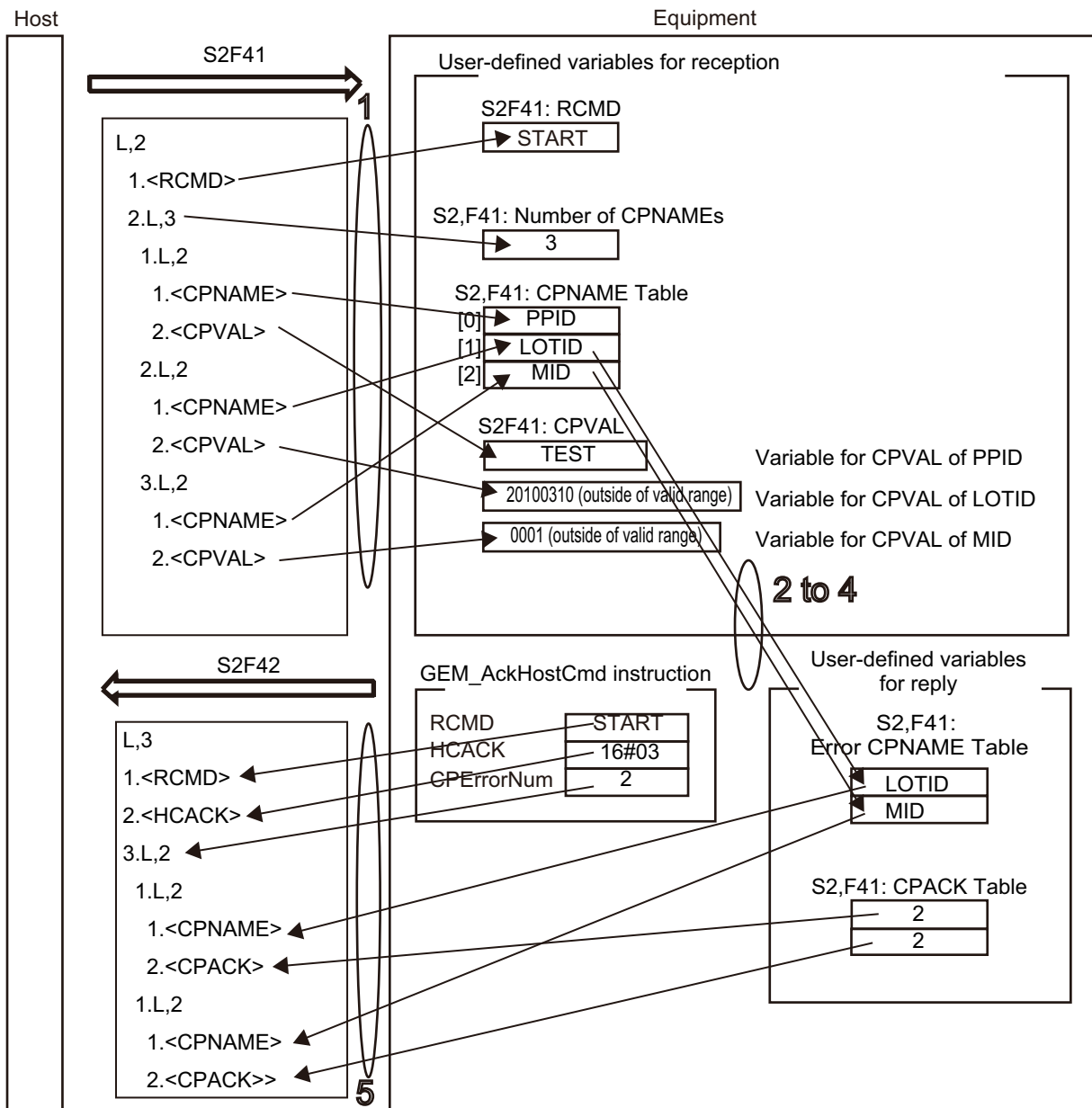

## Sample Programming

This sample sends the execution accept/reject result in reply to an execution request for a host command from the host.

The START host command is used in this example.

## SECS/GEM Configurator

First, the START host command is defined on the SECS/GEM Configurator.

Link variables for the operation settings of the host command are registered.

Name	Link variable
Link variable for S2F41: RCMD	S2F41_RCMD
Max number of CPNAMEs	3
Link variable for S2F41: CPNAMEs list - CPNAME Count	S2F41_CPNAME_NUMBER

Name	Link variable
Link variable for S2F41: CPNAMEs list - CPNAME Table	S2F41_CPNAME_TABLE
Link variable for S2F42: error CPNAME table	S2F42_CPNAME_TABLE
Link variable for S2F42: CPACK table	S2F42_CPACK_TABLE

The settings to register for CPNAME and CPVAL of the START host command on the *Host command definition* Tab Page are given in the following table.

CPNAME			CPVAL		
Name	Omission	Order fixed	Format	Data size	Link variable
PPID	ON	OFF	A	80	S2F41_START_PPID
LOTID	ON	OFF	A	16	S2F41_START_LOTID
MID	ON	OFF	A	16	S2F41_START_MID

Next, enter the programming on the Sysmac Studio.

An error will occur in the verification if the value of CPVAL for PPID, LOTID, or MID is an empty string.

## LD

Internal Variables	Variable	Data type	Initial value	Comment
	varHCACK	BYTE		Result acknowledge code
	varCPErrNum	UINT	0	Number of errors
	AckHostCmd_instance	GEM_AckHost Cmd		Instance of GEM_AckHostCmd instruction
	varCPACK	BYTE		Host command parameter acknowledge code
	index	INT		

External Variables	Variable	Comment
	_GEM_ServiceStatus	GEM Service status
	_GEM_BusyHostCmd	Host Command Transaction Processing Flag
	S2F41_RCMD	Variable for RCMD of the host command received from the host
	S2F41_CPNAME_NUMBER	Variable for number of CPNAMEs of the host command received from the host
	S2F41_CPNAME_TABLE	Variable for CPNAME of the host command received from the host
	S2F41_START_PPID	Variable for CPVAL when CPNAME of START host command is PPID
	S2F41_START_LOTID	Variable for CPVAL when CPNAME of START host command is LOTID
	S2F41_START_MID	Variable for CPVAL when CPNAME of START host command is MID
	S2F42_CPNAME_TABLE	Variable for number of CPNAMEs deemed to be in error
	S2F42_CPACK_TABLE	Variable for number of acknowledge codes deemed to be in error

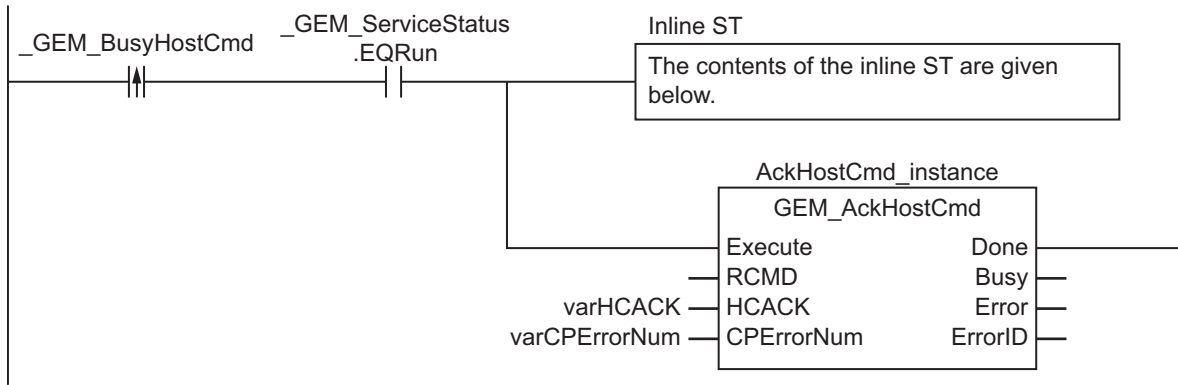

● Contents of Inline ST

```
// Verification
Clear( S2F42_CPNAME_TABLE );
Clear( S2F42_CPACK_TABLE );
varCPEErrorNum := 0;
varHCACK:=0;
IF( EQascii( S2F41_RCMD, 'START') =TRUE ) THEN
  IF ( S2F41_CPNAME_NUMBER <> 0 ) THEN
    // Parameter check for START host command
    FOR index:=INT#0 TO S2F41_CPNAME_NUMBER-1 BY INT#1 DO
      varCPACK :=0;
      IF( EQascii(S2F41_CPNAME_TABLE[index], 'PPID') = TRUE ) THEN
        IF( EQascii(S2F41_START_PPID, '') ) THEN
          varCPACK :=2;          // Illegal value specified for CPVAL.
        END_IF;
      ELSIF( EQascii(S2F41_CPNAME_TABLE[index], 'LOTID') = TRUE ) THEN
        IF( EQascii(S2F41_START_LOTID, '') ) THEN
          varCPACK :=2;          // Illegal value specified for CPVAL.
        END_IF;
      ELSIF( EQascii(S2F41_CPNAME_TABLE[index], 'MID') = TRUE ) THEN
        IF( EQascii(S2F41_START_MID, '') ) THEN
          varCPACK :=2;          // Illegal value specified for CPVAL.
        END_IF;
      ELSE
        varCPACK := 1;          // Parameter name CPNAME does not exist.
      END_IF;
      IF (varCPACK <> 0 ) THEN
        S2F42_CPNAME_TABLE[ varCPEErrorNum ] := S2F41_CPNAME_TABLE[index];
        S2F42_CPACK_TABLE[ varCPEErrorNum ] := varCPACK;
        varCPEErrorNum := varCPEErrorNum + 1;
      END_IF;
    END_FOR;
    IF ( varCPEErrorNum <> 0 ) THEN
      varHCACK := 3;          // At least one parameter is invalid.
    END_IF;
  END_IF;
ELSE
  varHCACK:=1;
END_IF;
```

**ST**

Internal Variables	Variable	Data type	Initial value	Comment
	varHCACK	BYTE		Result acknowledge code
	varCPErrorNum	UINT	0	Number of errors
	AckHostCmd_instance	GEM_AckHost Cmd		Instance of GEM_AckHostCmd instruction
	R_TRIG_instance	R_TRIG		Instance of R_TRIG instruction
	Trigger	BOOL	FALSE	Flag for FALSE to TRUE change in <i>_GEM_BusyHostCmd</i>
	Stage	INT	0	Program execution status
	varCPACK	BYTE		Host command parameter acknowledge code
	index	INT		

External Variables	Variable	Comment
	<i>_GEM_ServiceStatus</i>	GEM Service status
	<i>_GEM_BusyHostCmd</i>	Host Command Transaction Processing Flag
	S2F41_RCMD	Variable for RCMD of the host command received from the host
	S2F41_CPNAME_NUMBER	Variable for number of CPNAMEs of the host command received from the host
	S2F41_CPNAME_TABLE	Variable for CPNAME of the host command received from the host
	S2F41_START_PPID	Variable for CPVAL when CPNAME of START host command is PPID
	S2F41_START_LOTID	Variable for CPVAL when CPNAME of START host command is LOTID
	S2F41_START_MID	Variable for CPVAL when CPNAME of START host command is MID
	S2F42_CPNAME_TABLE	Variable for number of CPNAMEs deemed to be in error
	S2F42_CPACK_TABLE	Variable for number of acknowledge codes deemed to be in error

```

CASE Stage Of
0: // Notification of reception from host.
  R_TRIG_instance( _GEM_BusyHostCmd, Trigger );
  IF( Trigger = TRUE ) THEN
    // Initialization
    AckHostCmd_instance( Execute:=FALSE );
    // Host command verification
    IF( EQascii( S2F41_RCMD, 'START' ) =TRUE ) THEN
      Stage:=1;
    ELSE
      varHCACK:=1;
      varCPErrorNum := 0;
      Stage:=2;
    END_IF;
  END_IF;
1: // Verification
  Clear( S2F42_CPNAME_TABLE );
  Clear( S2F42_CPACK_TABLE );
  varCPErrorNum := 0;
  varHCACK:=0;
  IF ( S2F41_CPNAME_NUMBER <> 0 ) THEN
    // Parameter check for START host command
    FOR index:=INT#0 TO S2F41_CPNAME_NUMBER-1 BY INT#1 DO
      varCPACK :=0;

```



```

IF( EQascii(S2F41_CPNAME_TABLE[index], 'PPID') = TRUE ) THEN
  IF( EQascii(S2F41_START_PPID, '') ) THEN
    varCPACK :=2;          // Illegal value specified for CPVAL.
  END_IF;
ELSIF( EQascii(S2F41_CPNAME_TABLE[index], 'LOTID') = TRUE ) THEN
  IF( EQascii(S2F41_START_LOTID, '') ) THEN
    varCPACK :=2;          // Illegal value specified for CPVAL.
  END_IF;
ELSIF( EQascii(S2F41_CPNAME_TABLE[index], 'MID') = TRUE ) THEN
  IF( EQascii(S2F41_START_MID, '') ) THEN
    varCPACK :=2;          // Illegal value specified for CPVAL.
  END_IF;
ELSE
  varCPACK := 1;          // Parameter name CPNAME does not exist.
END_IF;
IF (varCPACK <> 0 ) THEN
  S2F42_CPNAME_TABLE[ varCPErrNum ] := S2F41_CPNAME_TABLE[index];
  S2F42_CPACK_TABLE[ varCPErrNum ] := varCPACK;
  varCPErrNum := varCPErrNum + 1;
END_IF;
END_FOR;
IF ( varCPErrNum <> 0 ) THEN
  varHCACK := 3;          // At least one parameter is invalid.
END_IF;
END_IF;
Stage := 2;
2: // Reply to host.
AckHostCmd_instance( Execute:=TRUE, HCACK:=varHCACK, CPErrNum:=varCPErrNum
);
IF( AckHostCmd_instance.Done = TRUE ) THEN
  Stage := 10;
ELSIF( AckHostCmd_instance.Error = TRUE ) THEN
  // Add error processing as required.
  Stage := 10;
END_IF;
10: // End
Stage := 0;
END_CASE;E

```

# GEM\_AckEnhancedRmtCmd

The GEM\_AckEnhancedRmtCmd instruction sends the execution accept/reject result in reply to an execution request for an enhanced remote command.

Instruction	Name	FB/ FUN	Graphic expression	ST expression
GEM_AckEnhancedRmtCmd	Acknowledge Enhanced Remote Command	FB		GEM_AckEnhancedRmtCmd_instance( Execute, RCMD, HCACK, CPErrNum, Done, Busy, Error, ErrorID);

## Variables

Name	Meaning	I/O	Description	Valid range	Unit	Default
RCMD	Command name		Received enhanced remote command name *1	81 bytes max. (including final NULL)*2		---
HCACK	Host command parameter acknowledge code	Input	Command accept/reject code 16#00: Acknowledged. Command was executed. 16#01: Command does not exist. 16#02: Cannot perform now. 16#03: At least one parameter is invalid. 16#04: Acknowledged. Command will be performed with completion signaled later. 16#05: Rejected. Already in desired condition. 16#06: No such object exists. 16#07 to 16#3F: Reserved.	16#00 to 16#3F	---	16#00
CPErrNum	Number of command parameter errors		Number of command parameters deemed in error	Depends on data type.		0

\*1. It is not necessary to set an input variable. The PPID from the enhanced remote command execution request is input automatically.

\*2. The maximum number of characters is set on the SECS/GEM Configurator. The maximum number of bytes is the maximum number of characters including the final NULL character plus 1.

	Boolean	Bit strings					Integers							Real numbers		Times, durations, dates, and text strings				
	BOOL	BYTE	WORD	DWORD	LWORD	USINT	UINT	UDINT	ULINT	SINT	INT	DINT	LINT	REAL	LREAL	TIME	DATE	TOD	DT	STRING
RCMD																				OK
HCACK		OK																		
CPErr Num						OK	OK			OK	OK									

### Function

The GEM\_AckEnhancedRmtCmd instruction sends the execution accept/reject result in reply to an execution request for an enhanced remote command from the host. The following are required for the reply.

- Command parameter acknowledge code  
 This code tells whether the enhanced remote command can be executed. The result is based on the following checks.
  - a) Is the enhanced remote command valid?
  - b) Can the enhanced remote command be executed?
- Number of command parameter errors  
 This is the number of error CEPVALs in the enhanced remote command.
- Detailed information on error CEPVAL values in the enhanced remote command
  - a) CPNAMEs of the CEPVAL values that were deemed to be in error
  - b) Acknowledge codes of the CEPVAL values that were deemed to be in error

Refer to the application procedure for this instruction for the processing to send a reply with the execution accept/reject result.

### Additional Information

- This instruction uses the Enhanced Remote Command scenario of the GEM Remote Control capability.
- A SECS message is sent if this instruction is executed and execution ends normally. The SECS message exchange between the equipment and host is given below.

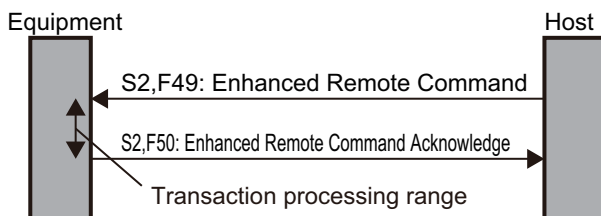

### Related System-defined Variables

Name	Meaning	Data type	Description
_GEM_Busy EnhancedRmtCmd	Enhanced Remote Command Transaction Processing Flag	BOOL	Gives the status of processing a transaction for an enhanced remote command.*1 TRUE: Processing FALSE: Not processing

Name	Meaning	Data type	Description
_GEM_Interlock EnhancedRmtCmd	Enhanced Remote Command Interlock	BOOL	Specifies whether to prohibit reception of enhanced remote commands from the host. TRUE: Prohibited FALSE: Granted
_GEM_ServiceStatus	GEM Service Status	_sGEM_SERVICE_STATUS	Gives the GEM Service status. Refer to P. A-212 for details.

\*1. This variable changes to TRUE when Enhanced Remote Command Send (S2,F49) is received. It will change to FALSE when execution of the instruction is completed normally.

## Related User-defined Variables

### ● Variables to Receive Enhanced Remote Command Requests

Name	Description	SECS/GEM Configurator setting
S2,F49: RCMD	Stores the RCMD of the enhanced remote command received from the host.	Enhanced Remote Command – Operation settings
S2,F49: OBJSPEC	Stores the OBJSPEC of the enhanced remote command received from the host.	
S2,F49: Number of CPNAMEs	Stores the number of enhanced remote command CPNAMEs received from the host.	
S2,F49: CPNAME Table	Stores the enhanced remote command CPNAMEs received from the host.	
S2,F49: Variable for CEPVAL	Stores the CEPVAL of the enhanced remote command CPNAME received from the host. There is a different variable for each CPNAME.	Enhanced Remote Command – Host command definition

### ● Variables to Reply to Enhanced Remote Command Requests

Name	Description	SECS/GEM Configurator setting
S2,F50: Error CPNAME Table	Stores the CPNAMEs of the CEPVALs that were deemed to be in error.	Enhanced Remote Command – Operation settings
S2,F50: CEPACK Table	Stores the acknowledge codes of the CEPACKs that were deemed to be in error.  16#01: Parameter name CPNAME does not exist. 16#02: An illegal value is specified for CEPVAL. 16#03: An illegal format is specified for CEPVAL. 16#04: Usage of parameter name CPNAME is not valid. 16#05 to 16#3F: Reserved.	

## Related Error Codes

Error code	Name	Description
16#3830	HACK Out of Range	The value of the HACK input variable is outside of the valid range.
16#041D	Exceeded Simultaneous Instruction Executed Resources	The number of simultaneously executed GEM instructions exceeded the limit.

Error code	Name	Description
16#3821	Invalid Size	The value specified in the <i>CPErrNum</i> input variable is larger than the number of array elements in <i>S2,F50: Error CPNAME Table</i> .
16#382F	Illegal CPNAME	A CPNAME specified in <i>S2,F50: Error CPNAME Table</i> is different from the received CPNAME.
16#3832	CEPACK Out of Range	The value in <i>S2,F50: CEPACK Table</i> is outside of the valid range.
16#3810	GEM Service Status in Initializing	The instruction was executed when the GEM Service status was Initializing.
16#3811	GEM Service Status in EQStarting	The instruction was executed when the GEM Service status was EQStarting.
16#3812	GEM Service Status in EQInitializing	The instruction was executed when the GEM Service status was EQInitializing.
16#3814	GEM Service Status in Stop	The instruction was executed when the GEM Service status was Stop.
16#3815	GEM Service Status in Error	The instruction was executed when the GEM Service status was Error.
16#3816	GEM Service Status in ShuttingDown	The instruction was executed when the GEM Service status was ShuttingDown.
16#3817	GEM Service Status in Shutdown	The instruction was executed when the GEM Service status was Shutdown.
16#3818	No Message Received	The instruction was executed when an enhanced remote command was not received.

### Precautions for Correct Use

- Before executing the instruction, confirm that all of the following conditions are met. If the instruction is executed when any of these conditions is not met, an error will occur and *Error* will change to TRUE.
  - a) *\_GEM\_ServiceStatus* must be *EQRun*.
  - b) *\_GEM\_BusyEnhancedRmtCmd* must be TRUE.
- In the following cases, *\_GEM\_BusyEnhancedRmtCmd* does not change to TRUE even if an enhanced remote command is received.
  - a) The RCMD received in the enhanced remote command does not exist in the receivable host commands set on the SECS/GEM Configurator.
  - b) The data type of RCMD, OBJSPEC, CPNAME, or CEPVAL did not agree between the received enhanced host command and the SECS/GEM Configurator setting.
  - c) The user-defined variable to store RCMD, OBJSPEC, CPNAME, or CEPVAL from the received enhanced remote command does not exist.
  - d) *\_GEM\_Interlock\_EnhancedRmtCmd* is TRUE.
  - e) Enhanced Remote Command (S2,F49) is disabled in the GEM message settings on the SECS/GEM Configurator.
- If the Omit parameter is enabled for the enhanced remote commands on the SECS/GEM Configurator, S2,F49: Variable for CEPVAL is not updated.
- Execution of the instruction will not end in an error even if the *RCMD* input variable specifies a command name that is different from the command name in *S2,F49: RCMD*.

## Application Procedure

Use the following procedure for this instruction.

### 1 Detecting Enhanced Remote Command Reception

Confirm that `_GEM_BusyEnhancedRmtCmd` changes from FALSE to TRUE.

Store the received enhanced remote command in the following variables.

- S2,F49: RCMD
- S2,F49: OBJSPEC
- S2,F49: Number of CPNAMEs
- S2,F49: CPNAME Table
- S2,F49: CEPVAL

### 2 Determining the Validity of the Enhanced Remote Command and Storing Error Information

Determine if the enhanced remote command is valid.

Examples of the criteria to determine validity are given below.

- Is the value of S2,F41: CPVAL correct?

If all of the CEPVAL values meet the above criteria, the host command parameter acknowledge code is 16#00. If even one of the CEPVAL values does not meet the above criteria, the host command parameter acknowledge code is 16#03. Store the error information for CEPVAL values that do not meet the criteria as follows:

- Store the CPNAME of the CEPVAL in *S2,F50: Error CPNAME Table*.
- Store the acknowledge code as the accept/reject result in *S2,F50: CEPVAL Table*.

### 3 Determining If the Enhanced Remote Command Can Be Executed

If the enhanced remote command is valid, determine if the enhanced remote command can be executed.

If it can be executed, the host command parameter acknowledge code is 16#00.

If it cannot be executed, the host command parameter acknowledge code is 16#02.

### 4 Executing Enhanced Remote Command

If the enhanced remote command can be executed, execute it.

If enhanced remote command execution completion will be reported as an event to the host after completion of the execution of this instructions, the host command parameter acknowledge code is 16#04.

If a response message will be sent as notification after completion of the execution of this instruction, the host command parameter acknowledge code is 16#00.

### 5 Sending the Enhanced Remote Command Execution Accept/Reject Result

Set the host command parameter acknowledge code from steps 2 to 4 for the *HCACK* input variable and execute the instruction. The enhanced remote command execution accept/reject result is sent to the host.

Refer to the application procedure for the *GEM\_AckHostCmd* on page A-50 for the user program processing and data flow of the application procedure.

## Sample Programming

Refer to the sample programming that is provided for the *GEM\_AckHostCmd* on page A-50.

# GEM\_ChangeECV

The GEM\_ChangeECV instruction changes the value of an equipment constant.

Instruction	Name	FB/ FUN	Graphic expression	ST expression
GEM_ChangeECV	Change Equipment Constant	FB		GEM_ChangeECV_instance( Execute, ECID, Value, Done, Busy, Error, ErrorID);

## Variables

Name	Meaning	I/O	Description	Valid range	Unit	Default
ECID	Equipment constant ID	Input	Equipment constant ID (ECID) to change	Depends on data type.	---	*1
Value	Value of equipment constant		New equipment constant value			

\*1. If you omit the input parameter, the default value is not applied. A building error will occur.

	Bool- ean	Bit strings				Integers							Real num- bers		Times, durations, dates, and text strings					
	BOOL	BYTE	WORD	DWORD	LWORD	USINT	UINT	UDINT	ULINT	SINT	INT	DINT	LINT	REAL	LREAL	TIME	DATE	TOD	DT	STRING
ECID						OK	OK	OK	OK	*1	*1	*1	*1							
Value	OK	OK	*1	*1	*1	OK	OK	OK	*1	OK	OK	OK	*1	OK	OK	*1	*1	*1	*1	OK
An array can also be specified.*2																				

\*1. An error will occur when the instruction is executed if this data type is specified for an input parameter.

\*2. You can specify only a BYTE array. An error will occur when the instruction is executed if an array of any other data type is specified.

## Function

The GEM\_ChangeECV instruction changes the value of the equipment constant specified with *ECID* to *Value*.

## Additional Information

- This instruction uses the Operator Changes Equipment Constant scenario for the GEM Equipment Constants capability.
- If the equipment constant is changed successfully, this instruction ends normally.

## Related System-defined Variables

Name	Meaning	Data type	Description
_GEM_ServiceStatus	GEM Service Status	_sGEM_ SER- VICE_STAT US	Gives the GEM Service status. Refer to P. A-212 for details.

## Related User-defined Variables

Name	Description	SECS/GEM Configurator setting
Number of Change Notification ECIDs* <sup>1</sup>	Stores the number of changed ECIDs.	Event notification – Event definitions
Change Notification ECID Table* <sup>1</sup>	Stores the changed ECIDs.	

\*1. These variables are used to report the Operator Equipment Constant Change collection event to the host.

## Related Error Codes

Error code	Name	Description
16#0419	Incorrect Data Type	The data type of the <i>ECID</i> input variable was not USINT, UINT, UDINT, or ULINT.
16#382D	Type Mismatch	The data type of the <i>Value</i> input variable is different from the data type specified on the SECS/GEM Configurator.
16#041D	Exceeded Simultaneous Instruction Executed Resources	The number of simultaneously executed GEM instructions exceeded the limit.
16#382C	Undefined ECID	The value of the <i>ECID</i> input variable is not registered on the SECS/GEM Configurator.
16#3820	Too Many Characters	The <i>Value</i> input variable has a STRING data type, but a longer text string was specified in <i>Value</i> than the number of characters set on the SECS/GEM Configurator.
16#382E	ECV Out of Range	The value specified for the <i>Value</i> input variable is outside of the range for the upper and lower limits that were set on the SECS/GEM Configurator.
16#3810	GEM Service Status in Initializing	The instruction was executed when the GEM Service status was Initializing.
16#3811	GEM Service Status in EQStarting	The instruction was executed when the GEM Service status was EQStarting.
16#3814	GEM Service Status in Stop	The instruction was executed when the GEM Service status was Stop.
16#3815	GEM Service Status in Error	The instruction was executed when the GEM Service status was Error.
16#3816	GEM Service Status in ShuttingDown	The instruction was executed when the GEM Service status was ShuttingDown.
16#3817	GEM Service Status in Shutdown	The instruction was executed when the GEM Service status was Shutdown.



## Precautions for Correct Use

- Before executing the instruction, confirm that all of the following conditions are met. If the instruction is executed when any of these conditions is not met, an error will occur and *Error* will change to TRUE.
  - a) *\_GEM\_ServiceStatus* must be EQInitializing or EQRun.
  - b) The value specified for the *ECID* input variable must be an ECID registered on the SECS/GEM Configurator.
  - c) The data type of the *Value* input variable must be the same as the data type specified on the SECS/GEM Configurator.
  - d) If the data type of the *Value* input variable is STRING, the number of characters specified in *Value* must be equal to or less than the number of characters that was set on the SECS/GEM Configurator.
- Use the *GEM\_ReportEvent* instruction to report an Operator Equipment Constant Change collection event to the host.

## Application Procedure

Use the following procedure for this instruction.

### 1 Changing the Value of the Equipment Constant

Specify the ID of the equipment constant to change in the *ECID* input variable and the value to change it to in the *Value* input variable, and then execute the instruction. Repeat the above step to change more than one equipment constant.

### 2 Reporting the Operator Equipment Constant Change Collection Event to the Host

Report the collection event to the host as required. Store the IDs of the equipment constants that were changed in step 1 in *Change Notification ECID Table* and the number of equipment constants that were changed in *Number of Change Notification ECIDs*. Then execute the *GEM\_ReportEvent* instruction.

## Sample Programming

This sample changes the *EstablishCommunicationsTimeout* equipment constant to 100.

After the equipment constant change is completed, an Operator Equipment Constant Change collection event is reported to the host. If the GEM Service status is EQRun and the *ChangeECV\_Start* internal variable changes from FALSE to TRUE, changing the equipment constant is started.

## SECS/GEM Configurator

Set the ECID and CEID.

Function	ID	Item	Value
Equipment constant	ECID	EstablishCommunicationsTimeout	1
Event	CEID	Operator Equipment Constant Change	20

# LD

Internal Variables	Variable	Data type	Initial value	Comment
	ChangeECV_Start	BOOL	FALSE	Flag to start changing equipment constant
	ChangeECV_ECID	UINT	0	Equipment constant ID
	EstablishCommunications-TimeoutValue	UINT	0	New value for <i>EstablishCommunicationsTimeout</i> equipment constant
	ChangeECV_CEID	UINT	0	Event ID for changing equipment constant by operator
	ChangeECV_instance	GEM_ChangeECV	---	Instance of GEM_ChangeECV instruction
	ChangeECVReportEvent_instance	GEM_ReportEvent	---	Instance of GEM_ReportEvent instruction

External Variables	Variable	Comment
	CHANGE_ECID_TABLE	Change Notification ECID Table
	CHANGE_ECID_NUMBER	Number of Change Notification ECIDs
	_GEM_ServiceStatus	GEM Service status

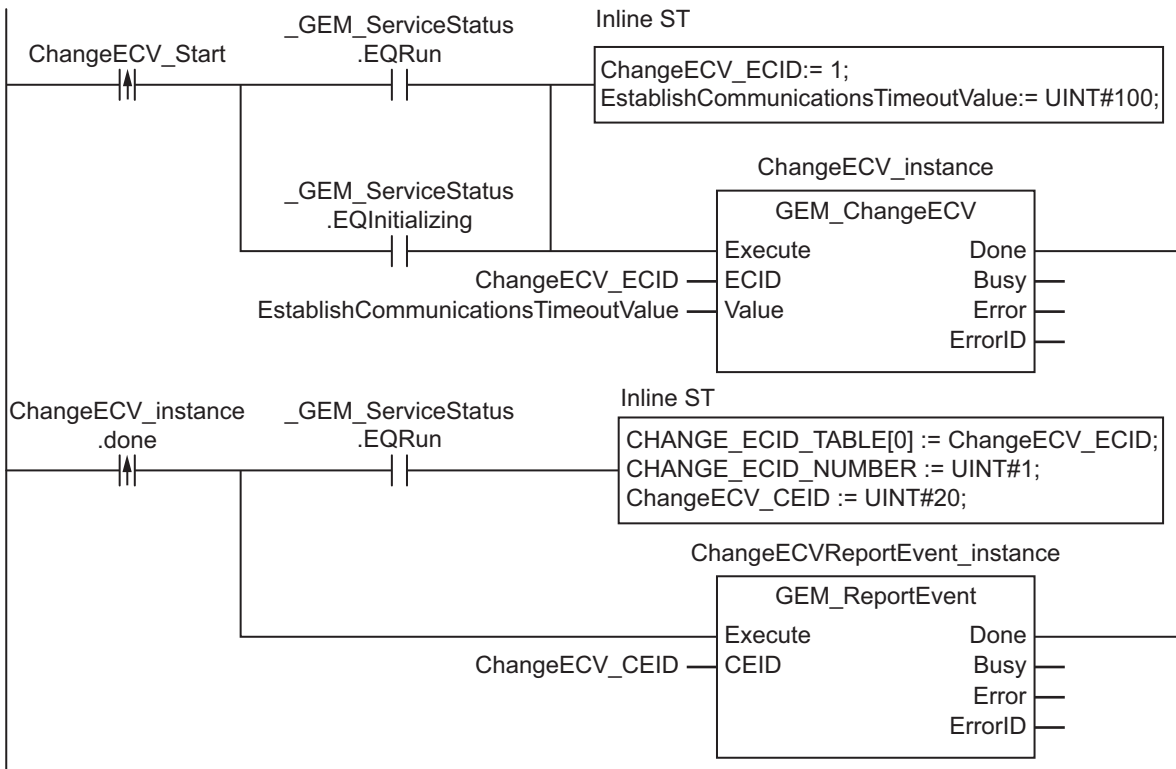

**ST**

Internal Variables	Variable	Data type	Initial value	Comment
	ChangeECV_Start	BOOL	FALSE	Flag to start changing equipment constant
	ChangeECV_ECID	UINT	0	Equipment constant ID
	EstablishCommunications-TimeoutValue	UINT	0	New value for <i>EstablishCommunicationsTimeout</i> equipment constant
	ChangeECV_CEID	UINT	0	Event ID for changing equipment constant by operator
	ChangeECV_instance	GEM_ChangeECV	---	Instance of GEM_ChangeECV instruction
	ChangeECVReportEvent_instance	GEM_ReportEvent	---	Instance of GEM_ReportEvent instruction
	R_TRIG_instance	R_TRIG		Instance of R_TRIG instruction
	Trigger	BOOL	FALSE	Flag for FALSE to TRUE change in <i>ChangeECV_Start</i>
	Stage	INT		Program execution status

External Variables	Variable	Comment
	CHANGE_ECID_TABLE	Change Notification ECID Table
	CHANGE_ECID_NUMBER	Number of Change Notification ECIDs
	_GEM_ServiceStatus	GEM Service status

```

CASE Stage Of
0: // Start
  R_TRIG_instance( ChangeECV_Start, Trigger );
  IF( (Trigger = TRUE)
    AND ( ( _GEM_ServiceStatus.EQInitializing = TRUE ) OR ( _GEM_ServiceStatus.EQRun =
TRUE ))) THEN
  // Initialization
  ChangeECV_CEID:=UINT#1;
  EstablishCommunicationsTimeoutValue := UINT#100;
  ChangeECV_instance( Execute:=FALSE,ECID:=ChangeECV_ECID,
Value:= EstablishCommunicationsTimeoutValue );
  ChangeECV_CEID := UINT#20;
  ChangeECVReportEvent_instance( Execute:= FALSE, CEID:=ChangeECV_CEID );
  // Record information in event notification table.
  CHANGE_ECID_TABLE[0] := ChangeECV_ECID;
  CHANGE_ECID_NUMBER := UINT#1;
  Stage := 1;
END_IF;
1: // Change equipment constant.
  ChangeECV_instance( Execute:=TRUE,ECID:=ChangeECV_ECID,
Value:= EstablishCommunicationsTimeoutValue );
  IF( ChangeECV_instance.Done = TRUE AND _GEM_ServiceStatus.EQRun = TRUE ) THEN
    Stage := 2;
  ELSIF( ChangeECV_instance.Error = TRUE ) THEN
    // Add error processing as required.
    Stage := 10;
  ELSE
    // Do not send event.
    Stage:= 10;
  END_IF;
2: // Notify host of change.
  ChangeECVReportEvent_instance( Execute:=TRUE, CEID:=ChangeECV_CEID );
  IF( ChangeECVReportEvent_instance.Done = TRUE ) THEN

```

```
        Stage := 10;
    ELSIF( ChangeECVReportEvent_instance.Error = TRUE ) THEN
        // Add error processing as required.
        Stage := 10;
    END_IF;
10: // End
    Stage := 0;
END_CASE;
```

# GEM\_AckChangeECV

The GEM\_AckChangeECV instruction sends the equipment constant change accept/reject result in reply to an equipment constant change request from the host.

Instruction	Name	FB/ FUN	Graphic expression	ST expression
GEM_AckChangeECV	Acknowledge Equipment Constant Change	FB		GEM_AckChangeECV_instance( Execute, EAC, Done, Busy, Error, ErrorID);

## Variables

Name	Meaning	I/O	Description	Valid range	Unit	Default
EAC	Equipment acknowledge code	Input	Reply to equipment constant change request 16#00: Acknowledge 16#01: Denied, at least one constant does not exist. 16#02: Denied, busy. 16#03: Denied, at least one constant is out of range. 16#04 to 16#3F: Reserved	16#00 to 16#3F	---	16#00

	Boolean	Bit strings					Integers							Real numbers		Times, durations, dates, and text strings				
	BOOL	BYTE	WORD	DWORD	LWORD	USINT	UINT	UDINT	ULINT	SINT	INT	DINT	LINT	REAL	LREAL	TIME	DATE	TOD	DT	STRING
EAC		OK																		

## Function

The GEM\_AckChangeECV instruction sends the equipment constant change accept/reject result in reply to an equipment constant change request from the host. The following are required for the reply.

- Equipment acknowledge code  
This is the accept/reject result for the equipment constant change request.

Refer to the application procedure for this instruction for the processing to send a reply with the equipment constant change accept/reject result.

## Additional Information

- This instruction uses the Host Sends Equipment Constants scenario for the GEM Equipment Constants capability.
- If this instruction is executed and execution ends normally, the equipment constant changes that were requested by the host are completed and a SECS message is sent. The SECS message exchange between the equipment and host is given below.

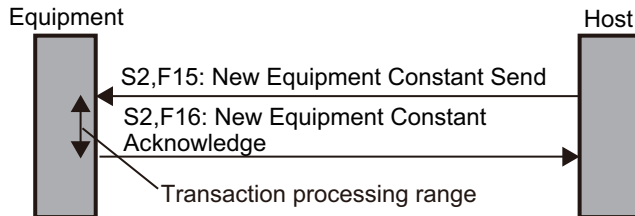

## Related System-defined Variables

Name	Meaning	Data type	Description
_GEM_BusyHostChangeECV	Host-initiated Equipment Constant Change Transaction Processing Flag	BOOL	Gives the status of processing a transaction for a host-initiated equipment constant change. <sup>*1</sup> TRUE: Processing FALSE: Not processing
_GEM_InterlockECV	Equipment Constant Interlock	BOOL	Specifies whether to prohibit equipment constant changes from the host. TRUE: Prohibited. FALSE: Granted
_GEM_ServiceStatus	GEM Service Status	_sGEM_-SERVICE_STAT US	Gives the GEM Service status. Refer to P. A-212 for details.

\*1. This variable changes to TRUE when New Equipment Constant Send (S2,F15) is received. It will change to FALSE when execution of the instruction is completed normally.

## Related User-defined Variables

Name	Description	SECS/GEM Configurator setting
Number of Change Request ECIDs	Stores the number of ECIDs for which a change request was received from the host.	Equipment Constant – Operation settings
Change Request ECID Table	Stores the ECIDs for which a change request was received from the host.	

## Related Error Codes

Error code	Name	Description
16#3836	EAC Out of Range	The value of the <i>EAC</i> input variable is outside of the valid range.
16#041D	Exceeded Simultaneous Instruction Executed Resources	The number of simultaneously executed GEM instructions exceeded the limit.
16#3810	GEM Service Status in Initializing	The instruction was executed when the GEM Service status was Initializing.
16#3811	GEM Service Status in EQStarting	The instruction was executed when the GEM Service status was EQStarting.
16#3812	GEM Service Status in EQInitializing	The instruction was executed when the GEM Service status was EQInitializing.
16#3814	GEM Service Status in Stop	The instruction was executed when the GEM Service status was Stop.
16#3815	GEM Service Status in Error	The instruction was executed when the GEM Service status was Error.
16#3816	GEM Service Status in ShuttingDown	The instruction was executed when the GEM Service status was ShuttingDown.
16#3817	GEM Service Status in Shutdown	The instruction was executed when the GEM Service status was Shutdown.
16#3818	No Message Received	The instruction was executed when an equipment constant change request was not received.

## Precautions for Correct Use

- Before executing the instruction, confirm that all of the following conditions are met. If the instruction is executed when any of these conditions is not met, an error will occur and *Error* will change to TRUE.
  - a) *\_GEM\_ServiceStatus* must be *EQRun*.
  - b) *\_GEM\_BusyHostChangeECV* must be TRUE.
- In the following cases, *\_GEM\_BusyHostChangeECV* does not change to TRUE even if New Equipment Constant Send (S2,F15) is received.
  - a) An equipment constant received from the host was not registered in the SECS/GEM Configurator.
  - b) The data type of the equipment constant is different between the data received from the host and the SECS/GEM Configurator setting.
  - c) An equipment constant value received from the host is outside of the valid range set in the SECS/GEM Configurator.
  - d) *\_GEM\_Interlock\_ECV* is TRUE.
  - e) New Equipment Constant Acknowledge (S2,F16) is disabled in the message settings on the SECS/GEM Configurator.

## Application Procedure

Use the following procedure for this instruction.

### 1 Detecting an Equipment Constant Change Request

Confirm that `_GEM_BusyHostChangeECV` changes from FALSE to TRUE.

Store the IDs of the equipment constants with change requests in the following variables.

- Change Request ECID Table
- Number of Change Request ECIDs

### 2 Determining Acceptance/Rejection of Equipment Constant Change Request

Determine if it is possible to change the ECIDs in Change Request ECID Table. Do this for the number of changes requested in *Number of Change Request ECIDs*. Conclude that changing is possible only if changing all of the equipment constants is possible.

If changing them is possible, the equipment acknowledge code is 16#00.

If changing them is not possible, the equipment acknowledge code is 16#02.

### 3 Sending the Accept/Reject Result for the Equipment Constant Change Request

Specify the equipment acknowledge code from step 2 in the *EAC* input variable and execute the instruction. The equipment constant change accept/reject result is sent to the host.

## Sample Programming

This sample sends the change accept/reject result in reply to an equipment constant change request.

### LD

Internal Variables	Variable	Data type	Initial value	Comment
	AckChangeECV_EAC	BYTE	0	Result acknowledge code
	AckChangeECV_instance	GEM_AckChangeECV		Instance of GEM_AckChangeECV instruction

External Variables	Variable	Comment
	_GEM_ServiceStatus	GEM Service status
	_GEM_BusyHostChangeECV	Host-initiated Equipment Constant Change Transaction Processing Flag

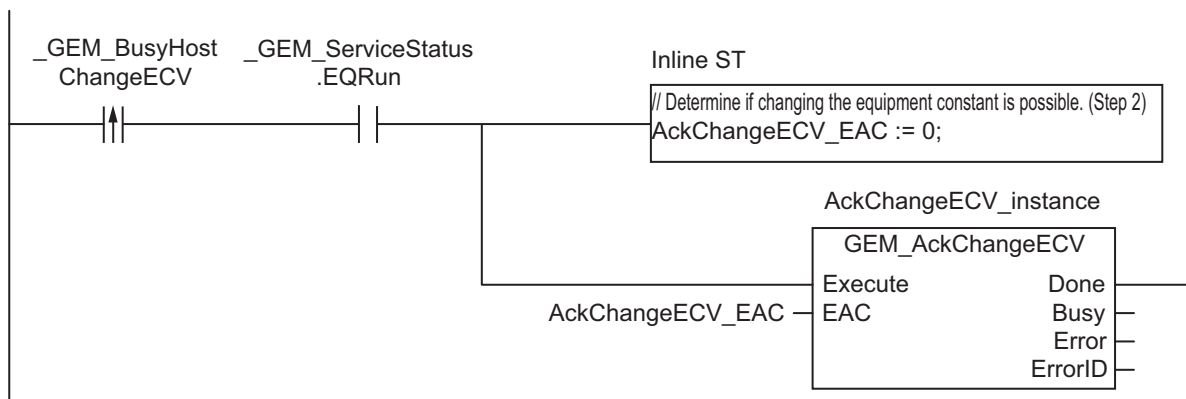



# ST

Internal Variables	Variable	Data type	Initial value	Comment
	AckChangeECV_EAC	BYTE	0	Result acknowledge code
	AckChangeECV_instance	GEM_AckChangeECV		Instance of GEM_AckChangeECV instruction
	R_TRIG_instance	R_TRIG		Instance of R_TRIG instruction
	Trigger	BOOL	FALSE	Flag for FALSE to TRUE change in <u>GEM_BusyHostChangeECV</u>
	Stage	INT	0	Program execution status

External Variables	Variable	Comment
	<u>GEM_ServiceStatus</u>	GEM Service status
	<u>GEM_BusyHostChangeECV</u>	Host-initiated Equipment Constant Change Transaction Processing Flag

```

CASE Stage Of
0: // Notification of reception from host.
  R_TRIG_instance( GEM_BusyHostChangeECV, Trigger );
  IF( Trigger = TRUE ) THEN
    // Determine if changing equipment constant is possible. (Step 2)
    AckChangeECV_EAC :=BYTE#0;
    // Initialization
    AckChangeECV_instance( Execute:=FALSE );
    Stage := 1;
  END_IF;
1:// Reply to host.
  // Start send.
  AckChangeECV_instance( Execute:=TRUE, EAC:=AckChangeECV_EAC );
  IF( AckChangeECV_instance.Done = TRUE ) THEN
    Stage := 10;
  ELSIF( AckChangeECV_instance.Error = TRUE ) THEN
    // Add error processing as required.
    Stage := 10;
  END_IF;
10: // End
  Stage := 0;
END_CASE;

```

# GEM\_AckPPDelete

The GEM\_AckPPDelete instruction sends a deletion accept/reject result in reply to a process program deletion request from the host.

Instruction	Name	FB/ FUN	Graphic expression	ST expression
GEM_AckPPDelete	Acknowledge Process Program Deletion	FB		GEM_AckPPDelete_instance( Execute, ACKC7, Done, Busy, Error, ErrorID);

## Variables

Name	Meaning	I/O	Description	Valid range	Unit	Default
ACKC7	Acknowledge code	Input	Result of process program deletion 16#00: Accepted 16#01: Permission not granted 16#02: Length error 16#03: Matrix overflow 16#04: PPID not found 16#05: Mode unsupported 16#06 to 16#3F: Other errors	16#00 to 16#3F	---	16#00

	Boolean	Bit strings					Integers							Real numbers		Times, durations, dates, and text strings				
	BOOL	BYTE	WORD	DWORD	LWORD	USINT	UINT	UDINT	ULINT	SINT	INT	DINT	LINT	REAL	LREAL	TIME	DATE	TOD	DT	STRING
ACKC7		OK																		

## Function

The GEM\_AckPPDelete instruction sends a deletion accept/reject result in reply to a process program deletion request from the host. The following are required for the reply.

- Acknowledge code

This is the process program deletion accept/reject result for the deletion request from the host.

Refer to the application procedure for this instruction for the processing to send a reply with the deletion accept/reject result.

### Additional Information

- This instruction uses the Process Program Deletion by Host scenario for the GEM Process Program Management capability.
- A SECS message is sent if this instruction is executed and execution ends normally. The SECS message exchange between the equipment and host is given below.

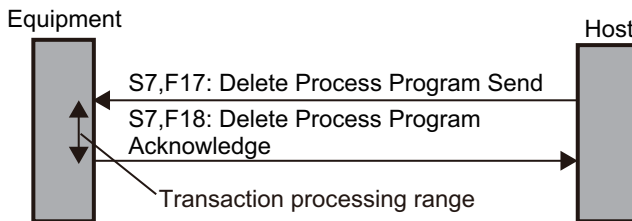

### Related System-defined Variables

Name	Meaning	Data type	Description
_GEM_BusyHostPPDelete	Host-initiated Process Program Deletion Transaction Processing Flag	BOOL	Gives the status of processing a transaction for a host-initiated process program deletion.*1 TRUE: Processing FALSE: Not processing
_GEM_InterLock_PP	Process Program Interlock	BOOL	Specifies whether to prohibit process program deletion requests and upload/download requests from the host. TRUE: Prohibited FALSE: Granted
_GEM_ServiceStatus	GEM Service Status	_sGEM_SERVICE_STATUS	Gives the GEM Service status. Refer to P. A-212 for details.

\*1. This variable changes to TRUE when a Delete Process Program Send (S7,F17) is received from the host. It will change to FALSE when execution of the instruction is completed normally.

### Related User-defined Variables

#### ● Equipment Management Variable

Name	Description	SECS/GEM Configurator setting
PPID Management Table	Used to manage PPID information inside the equipment. If the table contains NULL, no PPID information is registered.	Process Program – Operation settings

#### ● Variable to Receive Deletion Requests

Name	Description	SECS/GEM Configurator setting
Number of Deletion Request PPIDs	Stores the number of PPIDs for which a deletion request was received from the host. If the variable contains 0, no PPID management information is registered and all process programs are deleted.	Process Program – Operation settings
Deletion Request PPID Table	Stores the PPIDs for which a deletion request was received from the host.	

## Related Error Codes

Error code	Name	Description
16#3833	ACKC7 Out of Range	The value of <i>ACKC7</i> is outside of the valid range.
16#041D	Exceeded Simultaneous Instruction Executed Resources	The number of simultaneously executed GEM instructions exceeded the limit.
16#3810	GEM Service Status in Initializing	The instruction was executed when the GEM Service status was Initializing.
16#3811	GEM Service Status in EQStarting	The instruction was executed when the GEM Service status was EQStarting.
16#3812	GEM Service Status in EQInitializing	The instruction was executed when the GEM Service status was EQInitializing.
16#3814	GEM Service Status in Stop	The instruction was executed when the GEM Service status was Stop.
16#3815	GEM Service Status in Error	The instruction was executed when the GEM Service status was Error.
16#3816	GEM Service Status in ShuttingDown	The instruction was executed when the GEM Service status was ShuttingDown.
16#3817	GEM Service Status in Shutdown	The instruction was executed when the GEM Service status was Shutdown.
16#3818	No Message Received	The instruction was executed when a host command was not received.

## Precautions for Correct Use

- Before executing the instruction, confirm that all of the following conditions are met. If the instruction is executed when any of these conditions is not met, an error will occur and *Error* will change to TRUE.
  - a) *\_GEM\_ServiceStatus* must be *EQRun*.
  - b) *\_GEM\_BusyHostPPDelete* must be TRUE.
- In the following cases, *\_GEM\_BusyHostPPDelete* does not change to TRUE even if Delete Process Program Send (S7,F17) is received.
  - a) The PPID in the request is not in the PPID Management Table.
  - b) *\_GEM\_Interlock\_PP* is TRUE.
  - c) Delete Process Program Send (S7,F17) is disabled in the message settings on the SECS/GEM Configurator.
- If the value of *Number of Delete Request PPIDs* is 0, all PPIDs registered in the PPID Management Table are deleted.

## Application Procedure

Use the following procedure for this instruction.

- 1** Detecting the Process Program Deletion Request

Confirm that `_GEM_BusyHostPPDelete` changes from FALSE to TRUE.

Store the process program to delete in the following variables.

- Deletion Request PPID Table
- Number of Deletion Request PPIDs

## 2 Determining Acceptance/Rejection of Process Program Deletion

Determine if deleting the process programs with the PPIDs stored in *Deletion Request PPID Table* is possible. Do this for the number of deletions specified in *Number of Deletion Request ECIDs*. Conclude that deletion is possible only if deleting all of the equipment constants is possible.

If deleting them is possible, the acknowledge code is 16#00.

If deleting them is not possible, the acknowledge code is 16#05.

## 3 Deleting the Process Programs

If deletion is possible, delete the deletion requested PPIDs from *PPID Management Table*. Also delete the process programs with the deletion requested PPIDs that are saved in the equipment.

## 4 Sending the Result of Process Program Deletion

Specify the acknowledge code from step 2 in the *ACKC7* input variable and execute the instruction. The process program deletion accept/reject result is sent to the host.

The following diagram shows the user program processing and data flow for the application procedure. In this example, a process program deletion request is received from the host and the deletion is completed successfully. The PPIDs with deletion requests are TEST and DEL. Numbers 1 to 4 in the diagram indicate the steps in the application procedure.

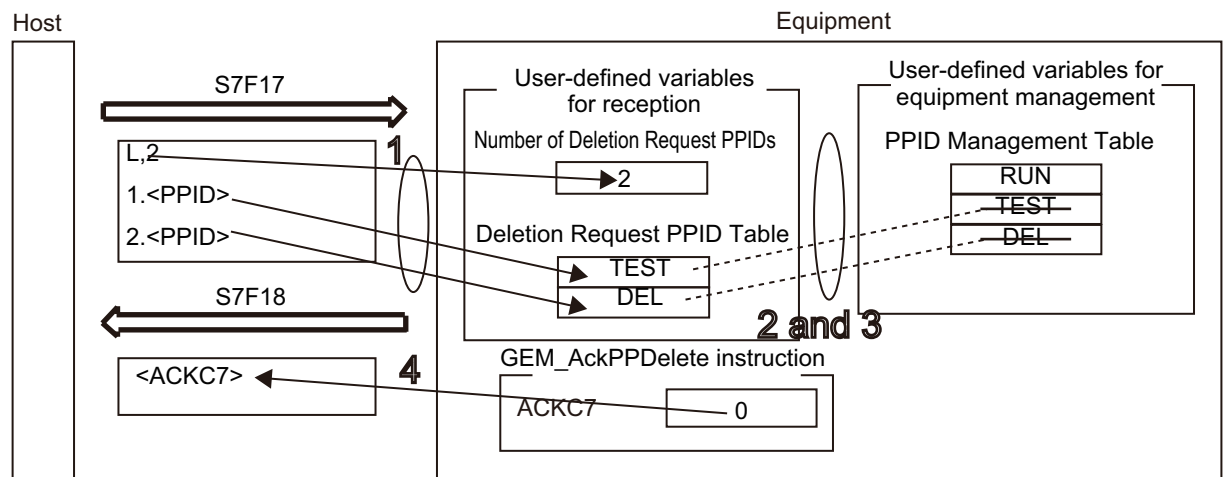

## Sample Programming

This sample sends the deletion accept/reject result in reply to a process program deletion request from the host.

## SECS/GEM Configurator

First, the relevant variables are registered on the SECS/GEM Configurator.

Only the items that are related to the `GEM_AckPPDelete` instruction are given in the following table.

### ● Process Program – Operation Settings

Item	Set value
Number of saved process programs	5
Link variable for PPID management table	PPID_TABLE
Link variable for deletion requested PPID list - PPID count	DELETE_PP_NUMBER
Link variable for deletion requested PPID list - PPID table	DELETE_PP_TABLE

Next, enter the programming on the Sysmac Studio.

## LD

Internal Variables	Variable	Data type	Initial value	Comment
	AckPPDelete_ACKC7	BYTE	0	Result acknowledge code
	AckPPDelete_instance	GEM_AckPPDelete		Instance of GEM_AckPPDelete instruction

External Variables	Variable	Comment
	_GEM_ServiceStatus	GEM Service status
	_GEM_BusyHostPPDelete	Host-initiated Process Program Deletion Transaction Processing Flag
	PPID_TABLE	Link variable for PPID management table
	DELETE_PP_NUMBER	Link variable for deletion requested PPID list - PPID count
	DELETE_PP_TABLE	Link variable for deletion requested PPID list - PPID table

Use the values of the *DELETE\_PP\_NUMBER* and *DELETE\_PP\_TABLE* variables to determine if deletion is possible in inline ST step 2. In step 3, create the programming to delete the PPID from *PPID\_TABLE* and create the programming to delete the process program saved in the equipment.

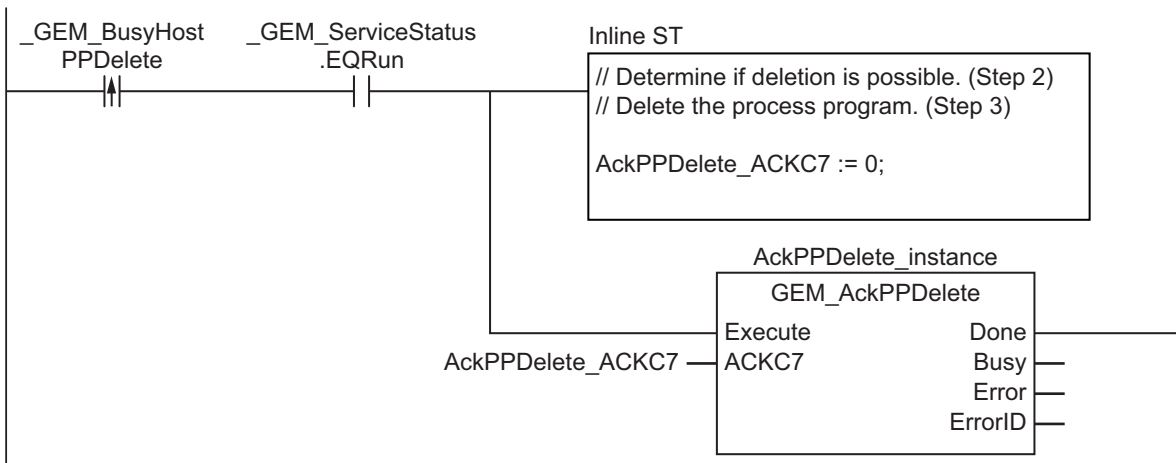

# ST

Internal Variables	Variable	Data type	Initial value	Comment
	AckPPDelete_ACKC7	BYTE	0	Result acknowledge code
	AckPPDelete_instance	GEM_AckPPDelete		Instance of GEM_AckPPDelete instruction
	R_TRIG_instance	R_TRIG		Instance of R_TRIG instruction
	Trigger	BOOL	FALSE	Flag for FALSE to TRUE change in <i>_GEM_BusyHostPPDelete</i>
	Stage	INT	0	Program execution status

External Variables	Variable	Comment
	<i>_GEM_ServiceStatus</i>	GEM Service status
	<i>_GEM_BusyHostPPDelete</i>	Host-initiated Process Program Deletion Transaction Processing Flag

```

CASE Stage Of
0: // Detect reception from host.
  R_TRIG_instance( _GEM_BusyHostPPDelete, Trigger );
  IF( Trigger = TRUE)THEN
    // Determine if deletion is possible. (Step 2)
    // Delete the process program. (Step 3)
    AckPPDelete_ACKC7 :=0;
    // Initialization
    AckPPDelete_instance( Execute:=FALSE );
    Stage:=1;
  END_IF;
1: // Reply to host.
  AckPPDelete_instance( Execute:=TRUE, ACKC7:=AckPPDelete_ACKC7 );
  IF( AckPPDelete_instance.Done = TRUE ) THEN
    Stage := 10;
  ELSIF( AckPPDelete_instance.Error = TRUE ) THEN
    // Add error processing as required.
    Stage := 10;
  END_IF;
10: // End
  Stage := 0;
END_CASE;

```

# GEM\_RespFormattedPPUpload

The GEM\_RespFormattedPPUpload instruction sends the formatted process program in reply to an upload formatted process program request from the host.

Instruction	Name	FB/ FUN	Graphic expression	ST expression
GEM_RespFormattedPPUpload	Respond to Formatted Process Program Upload	FB		GEM_RespFormattedPPUpload_instance( Execute, Rslt, PPID, MDLN, SOFTREV, CCODENum, Done, Busy, Error, ErrorID);

## Variables

Name	Meaning	I/O	Description	Valid range	Unit	Default
Rslt	Result	Input	Upload accept/reject result	Depends on data type.	---	TRUE
PPID	Process program ID		PPID to upload*1	121 bytes max. (including final NULL)*2		---
MDLN	Equipment model type		Equipment model type	21 bytes max. (including final NULL)*2		---
SOFTREV	Software revision code		Software revision code	21 bytes max. (including final NULL)*2		---
CCODENum	Number of CCODEs		Number of process program CCODEs to upload	Depends on data type.		---

\*1. It is not necessary to set an input variable. The PPID from the upload formatted process program request is automatically input.

\*2. The maximum number of characters is set on the SECS/GEM Configurator. The maximum number of bytes is the maximum number of characters including the final NULL character plus 1.

\*3. If you omit an input parameter, the default value is not applied. A building error will occur.

	Boolean	Bit strings					Integers							Real numbers		Times, durations, dates, and text strings				
	BOOL	BYTE	WORD	DWORD	LWORD	USINT	UINT	UDINT	ULINT	SINT	INT	DINT	LINT	REAL	LREAL	TIME	DATE	TOD	DT	STRING
Rslt	OK																			
PPID																				OK
MDLN																				OK
SOFTREV																				OK
CCODE Num						OK	OK			OK	OK									



## Function

The GEM\_RespFormattedPPUpload instruction sends the formatted process program in reply to an upload formatted process program request from the host. The following are required for the reply.

- Upload accept/reject result
  - Use the following criteria to determine if uploading the formatted process program is possible.
    - a) The formatted process program with the upload requested PPID exists in the equipment.
- Equipment model type
- Software revision code
- Formatted process program

This is the formatted process program with the PPID for which uploading was requested

Refer to the application procedure for this instruction for the processing to return the formatted process program.

## Additional Information

- This instruction uses the Host-initiated Formatted Process Program Upload scenario for the GEM Process Program Management capability.
- A SECS message is sent if this instruction is executed and execution ends normally. The SECS message exchange between the equipment and host is given below.

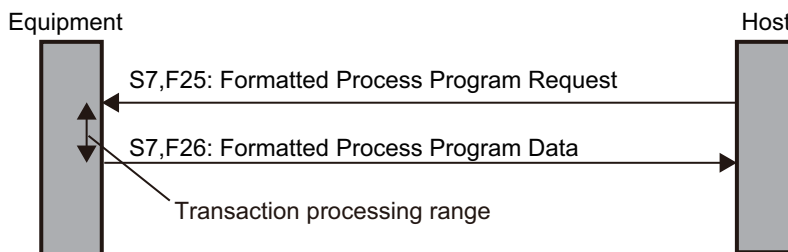

## Related System-defined Variables

Name	Meaning	Data type	Description
_GEM_Busy-HostFormattedPPUpload	Host-initiated Formatted Process Program Upload Transaction Processing Flag	BOOL	Gives the status of processing a transaction for a host-initiated formatted process program upload.*1 TRUE: Processing FALSE: Not processing
_GEM_Inter-Lock_PP	Process Program Inter-lock	BOOL	Specifies whether to prohibit process program deletion requests and upload/download requests from the host. TRUE: Prohibited FALSE: Granted
_GEM_ServiceStatus	GEM Service Status	_sGEM_SERVICE_STATUS	Gives the GEM Service status. Refer to P. A-212 for details.

\*1. When a Formatted Process Program Request (S7,F25) is received from the host, this variable changes to TRUE. It will change to FALSE when execution of the instruction is completed normally.

## Related User-defined Variables

### ● Equipment Management Variable

Name	Description	SECS/GEM Configurator setting
PPID Management Table	Used to manage PPID information inside the equipment. If the table contains NULL, no PPID information is registered.	Process Program

### ● Variable to Receive Upload Request

Name	Description	SECS/GEM Configurator setting
Host-initiated Upload Request Formatted PPID	Stores the formatted process program PPID for which a host requested an upload.	Process Program

### ● Variables to Acknowledge Upload Request

Name	Description	SECS/GEM Configurator setting
Host-initiated Upload CCODE Table	Stores the formatted process program CCODEs to upload.	Process Program
Host-initiated Upload PPARAM	Stores PPARAM for the formatted process program to upload.	

## Related Error Codes

Error code	Name	Description
16#3820	Too Many Characters	The number of characters in <i>MDLN</i> or <i>SOFTREV</i> exceeded the size set on the SECS/GEM Configurator.
16#041D	Exceeded Simultaneous Instruction Executed Resources	The number of simultaneously executed GEM instructions exceeded the limit.
16#3821	Invalid Size	The value specified in <i>CCODENum</i> is larger than the number of array elements in the <i>Host-initiated CCODE Table</i> user-defined variable.
16#3826	Undefined CCODE	A CCODE that was not defined in the SECS/GEM Configurator was specified in the <i>Host-initiated CCODE Table</i> user-defined variable.
16#3810	GEM Service Status in Initializing	The instruction was executed when the GEM Service status was Initializing.
16#3811	GEM Service Status in EQStarting	The instruction was executed when the GEM Service status was EQStarting.
16#3812	GEM Service Status in EQInitializing	The instruction was executed when the GEM Service status was EQInitializing.
16#3814	GEM Service Status in Stop	The instruction was executed when the GEM Service status was Stop.
16#3815	GEM Service Status in Error	The instruction was executed when the GEM Service status was Error.
16#3816	GEM Service Status in ShuttingDown	The instruction was executed when the GEM Service status was ShuttingDown.
16#3817	GEM Service Status in Shutdown	The instruction was executed when the GEM Service status was Shutdown.

Error code	Name	Description
16#3818	No Message Received	The instruction was executed when a formatted process program upload request was not received.

### Precautions for Correct Use

- Before executing the instruction, confirm that all of the following conditions are met. If the instruction is executed when any of these conditions is not met, an error will occur and *Error* will change to TRUE.
  - a) *\_GEM\_ServiceStatus* must be *EQRun*.
  - b) *\_GEM\_BusyHostFormattedPPUpload* must be TRUE.
- In the following cases, *\_GEM\_BusyHostFormattedPPUpload* does not change to TRUE even if a Formatted Process Program Request (S7,F25) is received.
  - a) The data type of the PPID set on the SECS/GEM Configurator and the data type of the PPID for the process program received from the host are different.
  - b) *\_GEM\_Interlock\_PP* is TRUE.
  - c) Formatted Process Program Request (S7,F25) is disabled in the message settings on the SECS/GEM Configurator.
- An error does not occur even if you specify a different PPID in *PPID* from the formatted process program PPID received from the host.

### Application Procedure

Use the following procedure for this instruction.

- 1** Detecting the Formatted Process Program Upload Request  
 Confirm that *\_GEM\_BusyHostFormattedPPUpload* changes from FALSE to TRUE.  
 Store the process program PPID for which uploading was requested in the following variable.
  - Host-initiated Upload Formatted PPID
- 2** Determining Acceptance/Rejection of Formatted Process Program Upload Request  
 Determine if uploading the formatted process program is possible. Confirm that the PPID stored in the *Host-initiated Upload Request Formatted PPID* variable exists in the *PPID Management Table* variable.
  - If It Exists:  
 Uploading is possible and the upload accept/reject result is TRUE.
  - If It Does Not Exist:  
 Uploading is not possible and the upload accept/reject result is FALSE.
- 3** Storing the Formatted Process Program to Upload  
 If uploading is possible, store the formatted process program with the requested PPID in the following variables.
  - Store CCODE in *Host-initiated CCODE Table*.
  - Store PPARM in *Host-initiated Upload PPARM*.
- 4** Returning the Formatted Process Program  
 Do the following and then execute the instruction. The formatted process program is sent to the host as the reply.
  - Store the upload accept/reject result in the *Rs/t* input variable.
  - Store the number of CCODEs in the *CCODENum* input variable.

The following diagram shows the user program processing and data flow for the application procedure. The diagram shows an example of a request from the host to upload the formatted process program with a PPID of RUN. Numbers 1 to 4 in the diagram indicate the steps in the application procedure.

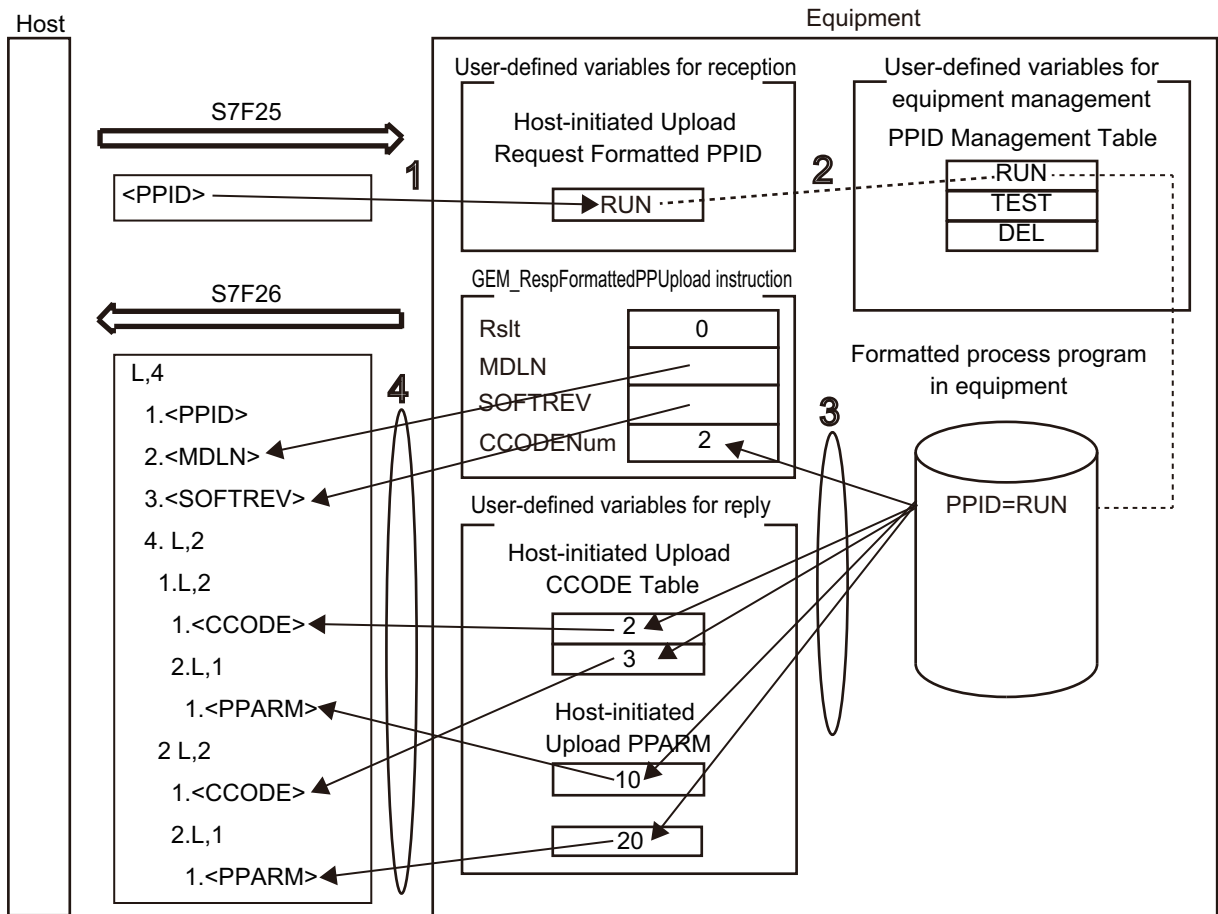

## Sample Programming

This sample sends the formatted process program in reply to an upload formatted process program request from the host.

Destination information is stored in the Sample1 formatted process program.

The structure of PPARM is as follows and is registered for CCODE = 1.

L,3
1.<I2 X>
2.<I2 Y>
3.<I2 Z>

The structure of PPARM is defined as shown on the left.  
 X: X coordinate  
 Y: Y coordinate  
 Z: Z coordinate

For CCODE = 2, the following is registered.

L,2
1.<U2 LimitMin>
2.<U2 LimitMax>

The structure of PPARM is defined as shown on the left.  
 LimitMin: Lower limit  
 LimitMax: Upper limit

## SECS/GEM Configurator

First, the relevant variables are registered on the SECS/GEM Configurator.

Only the items that are related to the GEM\_FormattedRespPPUUpload instruction are given in the following table.

### ● Process Program – Operation Settings

Item	Set value
Number of saved process programs	5
Link variable for PPID management table	PPID_TABLE

### ● Process Program – Formatted (1)

The formatted process program for the host-initiated upload is as follows:

CCODE	Description	Maximum number of PPARAMs	Format	Data size	Link variables	
1	Coordinates	3	I2	1	HOST_UPLOAD_FP-P_PPARAM1_TABLE	HOST_UPLOAD_FP-P_PPARAM1_NUMBER
2	Temperature	2	U2	1	HOST_UPLOAD_FPP_PPARAM1_TABLE	HOST_UPLOAD_FPP_PPARAM1_NUMBER

### ● Process Program - Formatted (2)

Item	Set value
Link variable for host-initiated upload - CCODE table	HOST_UPLOAD_FPP_CCODE_TABLE
Link variable for host-initiated upload - PPID of upload request	HOST_UPLOADREQ_FPP_PPID

Next, enter the programming on the Sysmac Studio.

**LD**

Internal Variables	Variable	Data type	Initial value	Comment
	varCCODENum	UINT	0	Number of CCODEs for formatted process program to upload
	varRespFormattedPPUploadRslt	BOOL	FALSE	Upload accept/reject result
	RespFormattedPPUpload_instance	GEM_RespFormattedPPUpload		Instance of GEM_RespFormattedPPUpload instruction

External Variables	Variable	Comment
	_GEM_ServiceStatus	GEM Service status
	_GEM_EquipInfo	Equipment information
	_GEM_BusyHostFormattedPPUpload	Host-initiated Formatted Process Program Upload Transaction Processing Flag
	HOST_UPLOAD_FPP_PPARAM1_TABLE	Link variable for PPARAM table for CCODE = 1
	HOST_UPLOAD_FPP_PPARAM1_NUMBER	Link variable for PPARAM count for CCODE = 1
	HOST_UPLOAD_FPP_CCODE_TABLE	Link variable for host-initiated upload - CCODE table
	HOST_UPLOADREQ_FPP_PPID	Link variable for host-initiated upload - PPID of upload request

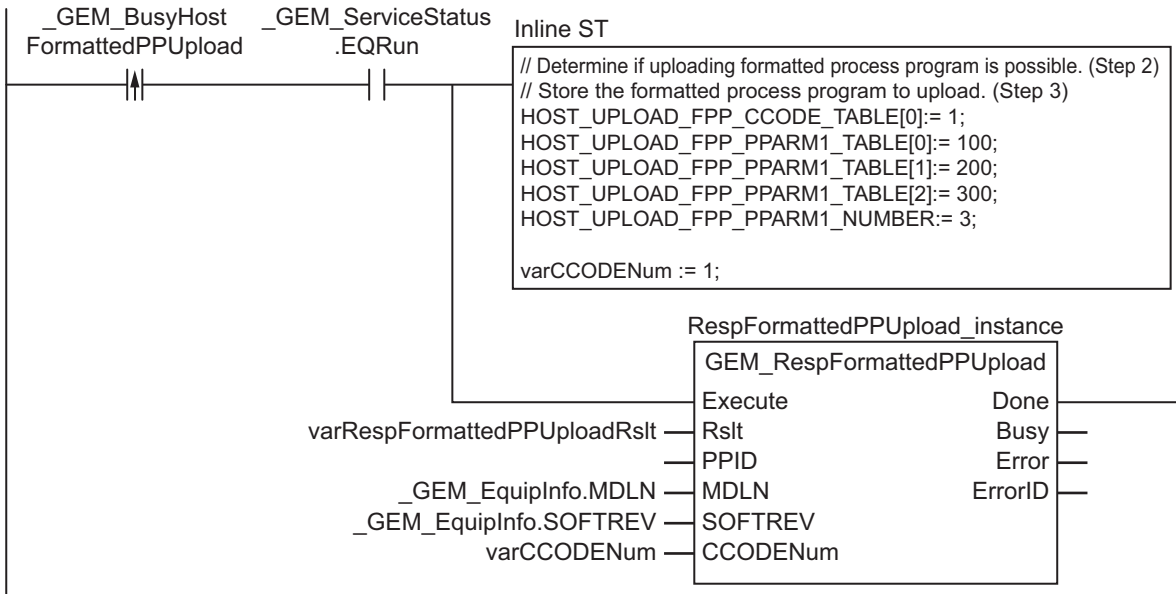

Note In inline ST step 2, add the programming to determine whether to save the PPID in the PPID Management Table.

**ST**

Internal Variables	Variable	Data type	Initial value	Comment
	varCCODENum	UINT	0	Number of CCODEs for formatted process program to upload
	varRespFormattedPPUploadRslt	BOOL	FALSE	Upload accept/reject result
	RespFormattedPPUpload_instance	GEM_RespFormattedPPUpload		Instance of GEM_RespFormattedPPUpload instruction
	R_TRIG_instance	R_TRIG		Instance of R_TRIG instruction
	Trigger	BOOL	FALSE	Flag for FALSE to TRUE change in <i>_GEM_BusyHostFormattedPPUpload</i> .
	Stage	INT	0	Program execution status

External Variables	Variable	Comment
	_GEM_ServiceStatus	GEM Service status
	_GEM_EquipInfo	Equipment information
	_GEM_BusyHostFormattedPPUpload	Host-initiated Formatted Process Program Upload Transaction Processing Flag
	HOST_UPLOAD_FPP_PPARAM1_TABLE	Link variable for PPARAM table for CCODE = 1
	HOST_UPLOAD_FPP_PPARAM1_NUMBER	Link variable for PPARAM count for CCODE = 1
	HOST_UPLOAD_FPP_CCODE_TABLE	Link variable for host-initiated upload - CCODE table
	HOST_UPLOADREQ_FPP_PPID	Link variable for host-initiated upload - PPID of upload request

```

CASE Stage Of
0: // Detect reception from host.
  R_TRIG_instance( _GEM_BusyHostFormattedPPUpload, Trigger );
  IF(Trigger = TRUE)THEN
    // Determine if formatted process program can be uploaded. (Step 2)
    // Store the formatted process program to upload. (Step 3)
    HOST_UPLOAD_FPP_CCODE_TABLE[0] := 1;
    HOST_UPLOAD_FPP_PPARAM1_TABLE[0] := 100;
    HOST_UPLOAD_FPP_PPARAM1_TABLE[1] := 200;
    HOST_UPLOAD_FPP_PPARAM1_TABLE[2] := 300;
    HOST_UPLOAD_FPP_PPARAM1_NUMBER := 3;
    varCCODENum := 1;
    varRespFormattedPPUploadRslt := TRUE;
    // Initialization
    RespFormattedPPUpload_instance( Execute:=FALSE,
      Rslt:=varRespFormattedPPUploadRslt,
      MDLN:= _GEM_EquipInfo.MDLN,
      SOFTREV:= _GEM_EquipInfo.SOFTREV,
      CCODENum:= varCCODENum );
    Stage:=1;
  END_IF;
1: // Upload process program to host.
  RespFormattedPPUpload_instance( Execute:=TRUE,
    Rslt:=varRespFormattedPPUploadRslt,
    MDLN:= _GEM_EquipInfo.MDLN,
    SOFTREV:= _GEM_EquipInfo.SOFTREV,
    CCODENum:= varCCODENum );
  IF( RespFormattedPPUpload_instance.Done = TRUE ) THEN
    Stage := 10;
  
```

```
ELSIF(RespFormattedPPUpload_instance.Error = TRUE ) THEN
    Stage := 10;
END_IF;
10: // End
    Stage := 0;
END_CASE;
```



# GEM\_RespPPUpload

The GEM\_RespPPUpload instruction sends the process program in reply to a process program upload request from the host.

Instruction	Name	FB/ FUN	Graphic expression	ST expression
GEM_RespPP Upload	Respond to Process Program Upload	FB		GEM_RespPPUpload_instance( Execute, Rslt, PPID, LENGTH, Done, Busy, Error, ErrorID);

## Variables

Name	Meaning	I/O	Description	Valid range	Unit	Default
Rslt	Result	Input	Upload accept/reject result	Depends on data type.	---	TRUE
PPID	Process program ID		PPID to upload*1	121 bytes max. (including final NULL) *2		---
LENGTH	Process program byte length		Process program (PPBODY) byte length	Depends on data type.		*3

\*1. It is not necessary to set an input variable. The PPID from the upload process program request is automatically input.

\*2. The maximum number of characters is set on the SECS/GEM Configurator. The maximum number of bytes is the maximum number of characters including the final NULL character plus 1.

\*3. If you omit the input parameter, the default value is not applied. A building error will occur.

	Bool- ean	Bit strings					Integers							Real num- bers		Times, durations, dates, and text strings				
	BOOL	BYTE	WORD	DWORD	LWORD	USINT	UINT	UDINT	ULINT	SINT	INT	DINT	LINT	REAL	LREAL	TIME	DATE	TOD	DT	STRING
Rslt	OK																			
PPID																				OK
LENGTH						OK	OK	OK		OK	OK	OK								

## Function

The GEM\_RespPPUpload instruction sends the process program in reply to a process program upload request from the host. The following are required for the reply.

- Upload accept/reject result  
Use the following criteria to determine if uploading the process program is possible.
  - a) The process program with the upload requested PPID exists in the equipment.
- Process program  
This is the process program in the equipment with the PPID for which uploading was requested.
- Process program byte length  
This is the byte length of the process program.

Refer to the application procedure for this instruction for the processing to return the process program.

## Additional Information

- This instruction uses the Host-initiated Process Program Upload scenario for the GEM Process Program Management capability.
- A SECS message is sent if this instruction is executed and execution ends normally. The SECS message exchange between the equipment and host is given below.

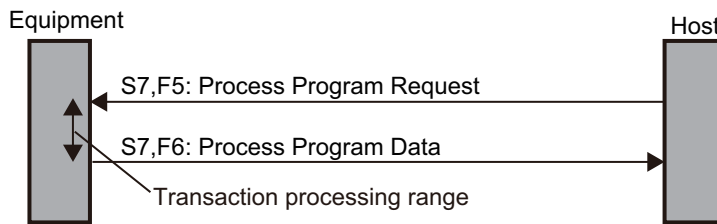

## Related System-defined Variables

Name	Meaning	Data type	Description
_GEM_BusyHostPPUpload	Host-initiated Process Program Upload Transaction Processing Flag	BOOL	Gives the status of processing a transaction for a host-initiated process program upload.*1 TRUE: Processing FALSE: Not processing
_GEM_InterLock_PP	Process Program Interlock	BOOL	Specifies whether to prohibit process program deletion requests and upload/download requests from the host. TRUE: Prohibited FALSE: Granted
_GEM_ServiceStatus	GEM Service Status	_sGEM_- SER- VICE_STAT US	Gives the GEM Service status. Refer to P. A-212 for details.

\*1. This variable changes to TRUE when a Process Program Request (S7,F5) is received from the host. It will change to FALSE when execution of the instruction is completed normally.

## Related User-defined Variables

### ● Equipment Management Variable

Name	Description	SECS/GEM Configurator setting
PPID Management Table	Used to manage PPID information inside the equipment. If the table contains NULL, no PPID information is registered.	Process Program – Unformatted

### ● Variable to Receive Upload Request

Name	Description	SECS/GEM Configurator setting
Host-initiated Upload Request PPID	Stores the process program PPID for which a host requested an upload.	Process Program – Unformatted

### ● Variable to Respond to Upload Request

Name	Description	SECS/GEM Configurator setting
Host-initiated Upload PP Data	Stores the process program data to upload.	Process Program

## Related Error Codes

Error code	Name	Description
16#041D	Exceeded Simultaneous Instruction Executed Resources	The number of simultaneously executed GEM instructions exceeded the limit.
16#3821	Invalid Size	<p><i>LENGTH</i> that was specified for the <i>Upload PP Data</i> user-defined variable is not correct.</p> <ul style="list-style-type: none"> <li>A value that is larger than the data size of <i>Upload PP Data</i> was specified.</li> <li>A value that cannot be evenly divided by the size of the data type of <i>Upload PP Data</i> was specified.</li> </ul>
16#3810	GEM Service Status in Initializing	The instruction was executed when the GEM Service status was Initializing.
16#3811	GEM Service Status in EQStarting	The instruction was executed when the GEM Service status was EQStarting.
16#3812	GEM Service Status in EQInitializing	The instruction was executed when the GEM Service status was EQInitializing.
16#3814	GEM Service Status in Stop	The instruction was executed when the GEM Service status was Stop.
16#3815	GEM Service Status in Error	The instruction was executed when the GEM Service status was Error.
16#3816	GEM Service Status in ShuttingDown	The instruction was executed when the GEM Service status was ShuttingDown.
16#3817	GEM Service Status in Shutdown	The instruction was executed when the GEM Service status was Shutdown.
16#3818	No Message Received	The instruction was executed when a process program upload request was not received.

## Precautions for Correct Use

- Before executing the instruction, confirm that all of the following conditions are met. If the instruction is executed when any of these conditions is not met, an error will occur and *Error* will change to TRUE.
  - a) *\_GEM\_ServiceStatus* must be *EQRun*.
  - b) *\_GEM\_BusyHostPPUpload* must be TRUE.
- In the following cases, *\_GEM\_BusyHostPPUpload* does not change to TRUE even if a Process Program Request (S7,F5) is received.
  - a) The data types of the PPID set on the SECS/GEM Configurator and the PPID for the process program received from the host are different.
  - b) *\_GEM\_Interlock\_PP* is TRUE.
  - c) Process Program Request (S7,F5) is disabled in the message settings on the SECS/GEM Configurator.
- Even if you specify a different PPID in the *PPID* input variable from the one that was received, an error end will not occur.

## Application Procedure

Use the following procedure for this instruction.

### 1 Detecting the Process Program Upload Request

Confirm that *\_GEM\_BusyHostPPUpload* changes from FALSE to TRUE.

Store the process program PPID for which uploading was requested in the following variable.

- Host-initiated Upload Request PPID

### 2 Determining Acceptance/Rejection of Process Program Upload

Determine if uploading the process program is possible. Confirm that the PPID stored in the *Host-initiated Upload Request PPID* variable exists in the *PPID Management Table* variable.

- If It Exists:
  - Uploading is possible and the upload accept/reject result is TRUE.
- If It Does Not Exist:
  - Uploading is not possible and the upload accept/reject result is FALSE.

### 3 Storing the Process Program Data to Upload

If uploading is possible, store the process program with the requested PPID in the equipment in the following variable.

- Host-initiated Upload PP Data

### 4 Returning the Process Program

Do the following and then execute the instruction. The process program is sent to the host as the reply.

- Store the upload accept/reject result in the *Rs/t* input variable.
- Store the byte length of the process program data to upload in the *LENGTH* input variable.

The following diagram shows the user program processing and data flow for the application procedure. The diagram shows an example of a request from the host to upload the process program with a PPID of *RUN*. Numbers 1 to 4 in the diagram indicate the steps in the application procedure.

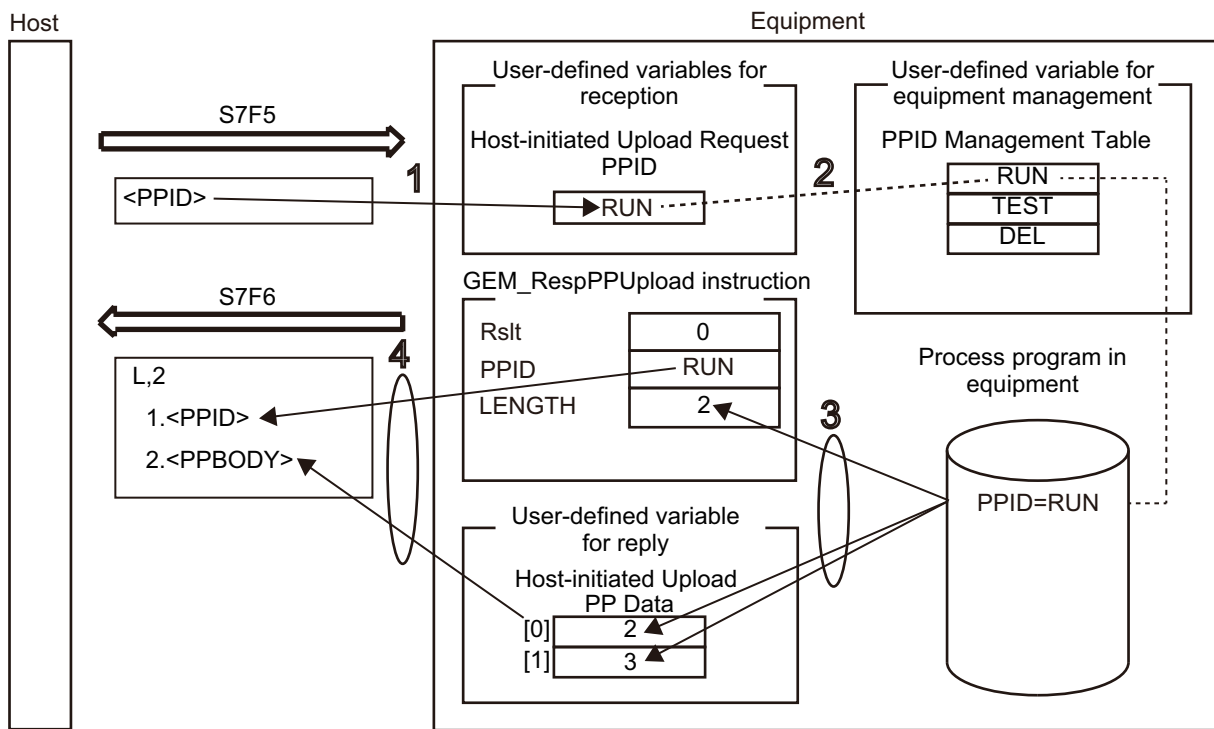

### Sample Programming

This sample sends the process program in reply to a process program upload request from the host.

### SECS/GEM Configurator

First, the relevant variables are registered on the SECS/GEM Configurator.

Only the items that are related to the GEM\_RespPPUUpload instruction are given in the following table.

#### ● Process Program – Operation Settings

Item	Set value
Number of saved process programs	5
Link variable for PPID management table	PPID_TABLE

#### ● Process Program – Unformatted

Item	Set value
PPBODY format	B
PPBODY data size	10
Link variable for host-initiated upload - PPBODY	HOST_UPLOAD_PPBODY
Link variable for host-initiated upload - PPID of upload request	HOST_UPLOADREQ_PPID

Next, enter the programming on the Sysmac Studio.

# LD

Internal Variables	Variable	Data type	Initial value	Comment
	varHostUploadLENGTH	UINT	0	Process program byte length
	varRespPPUploadRslt	BOOL	FALSE	Upload accept/reject result
	RespPPUpload_instance	GEM_RespPP Upload		Instance of GEM_RespPPUpload instruction
	localPPData	ARRAY[0..9] OF BYTE	[16#01, 16#23, 16#45, 16#67, 16#89, 16#01, 16#23, 16#45, 16#67, 16#89]	Process program data to upload

External Variables	Variable	Comment
	_GEM_ServiceStatus	GEM Service status
	_GEM_BusyHostPPUpload	Host-initiated Process Program Upload Transaction Processing Flag
	PPID_TABLE	Link variable for PPID management table
	HOST_UPLOAD_PPBODY	Link variable for host-initiated upload - PPBODY
	HOST_UPLOADREQ_PPID	Link variable for host-initiated upload - PPID of upload request

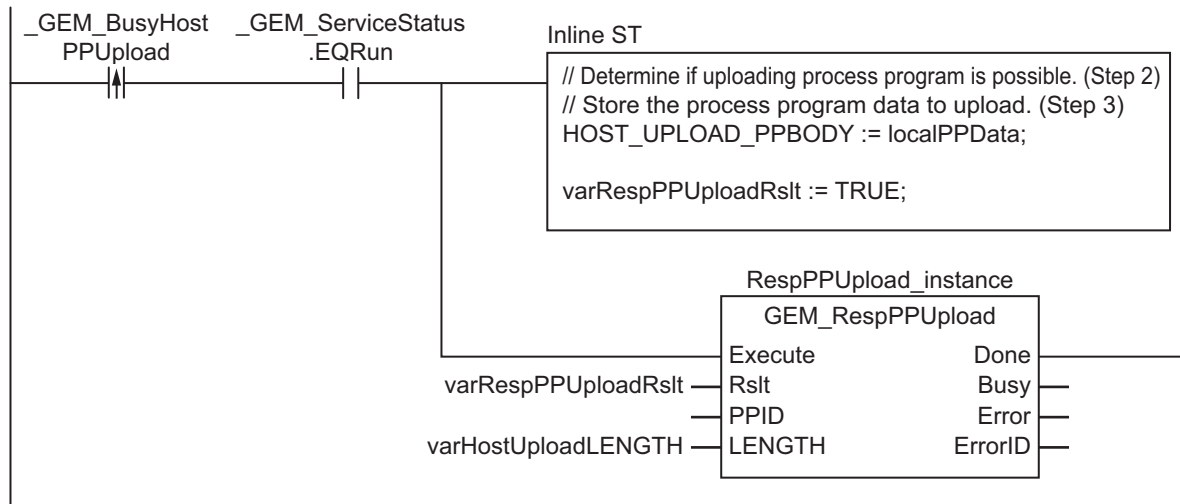

Note In inline ST step 2, add the programming to determine whether to save the PPID in the PPID Management Table.

**ST**

Internal Variables	Variable	Data type	Initial value	Comment
	varHostUploadLENGTH	UINT	0	Process program byte length
	varRespPPUploadRslt	BOOL	FALSE	Upload accept/reject result
	RespPPUpload_instance	GEM_RespPP Upload		Instance of GEM_RespPPUpload instruction
	R_TRIG_instance	R_TRIG		Instance of R_TRIG instruction
	Trigger	BOOL	FALSE	Flag for FALSE to TRUE change in <i>_GEM_BusyHostPPUpload</i> .
	Stage	INT	0	Program execution status
	localPPData	ARRAY[0..9] OF BYTE	[16#01, 16#23, 16#45, 16#67, 16#89, 16#01, 16#23, 16#45, 16#67, 16#89]	Process program data to upload

External Variables	Variable	Comment
	<i>_GEM_ServiceStatus</i>	GEM Service status
	<i>_GEM_BusyHostPPUpload</i>	Host-initiated Process Program Upload Transaction Processing Flag
	PPID_TABLE	Link variable for PPID management table
	HOST_UPLOAD_PPBODY	Link variable for host-initiated upload - PPBODY
	HOST_UPLOADREQ_PPID	Link variable for host-initiated upload - PPID of upload request

```

CASE Stage Of
0: // Detect reception from host.
  R_TRIG_instance( _GEM_BusyHostPPUpload, Trigger );
  IF(Trigger = TRUE)THEN
    // Determine if uploading process program is possible. (Step 2)
    // Store the process program data to upload. (Step 3)
    HOST_UPLOAD_PPBODY := localPPData;
    // Initialization
    RespPPUpload_instance( Execute:=FALSE, Rslt:=varRespPPUploadRslt,LENGTH:=varHostUploadLENGTH );
    Stage:=1;
  END_IF;
1: // Upload process program to host.
  RespPPUpload_instance( Execute:=TRUE, Rslt:=varRespPPUploadRslt,LENGTH:=varHostUploadLENGTH );
  IF( RespPPUpload_instance.Done = TRUE ) THEN
    Stage := 10;
  ELSIF( RespPPUpload_instance.Error = TRUE ) THEN
    // Add error processing as required.
    Stage := 10;
  END_IF;
10: // End
  Stage := 0;
END_CASE;

```

# GEM\_UploadFormattedPP

The GEM\_UploadFormattedPP instruction uploads a formatted process program to the host.

Instruction	Name	FB/ FUN	Graphic expression	ST expression
GEM_UploadFormattedPP	Upload Formatted Process Program	FB		<pre>GEM_UploadFormattedPP_ instance(     Execute,     PPID,     MDLN,     SOFTREV,     CCODENum,     Done,     Busy,     Error,     ErrorID);</pre>

## Variables

Name	Meaning	I/O	Description	Valid range	Unit	Default
PPID	Process program ID	Input	PPID to upload	121 bytes max. (including final NULL) *1	---	*2
MDLN	Equipment model type		Equipment model type	21 bytes max. (including final NULL)*1		
SOFTREV	Software revision code		Software revision code			
CCODENum	Number of CCODEs		Number of process program CCODEs to upload	Depends on data type.		

\*1. The maximum number of characters is set on the SECS/GEM Configurator. The maximum number of bytes is the maximum number of characters including the final NULL character plus 1.

\*2. If you omit the input parameter, the default value is not applied. A building error will occur.

	Boolean	Bit strings				Integers							Real numbers		Times, durations, dates, and text strings					
	BOOL	BYTE	WORD	DWORD	LWORD	USINT	UINT	UDINT	ULINT	SINT	INT	DINT	LINT	REAL	LREAL	TIME	DATE	TOD	DT	STRING
PPID																				OK
MDLN																				OK
SOFTREV																				OK
CCODE Num						OK	OK			OK	OK									



## Function

The GEM\_UploadFormattedPP instruction uploads a formatted process program to the host.

The following are required for the upload.

- Process program ID  
This is the PPID of the formatted process program to upload.
- Equipment model type
- Software revision code
- Formatted process program  
This is the formatted process program to upload.
- Number of CCODEs  
This is the number of CCODEs for the formatted process program to upload.

Refer to the application procedure for this instruction for the processing to upload the formatted process program.

## Additional Information

- This instruction uses the Equipment-initiated Formatted Process Program Upload scenario for the GEM Process Program Management capability.
- A SECS message is sent if this instruction is executed and execution ends normally. The SECS message exchange between the equipment and host is given below.

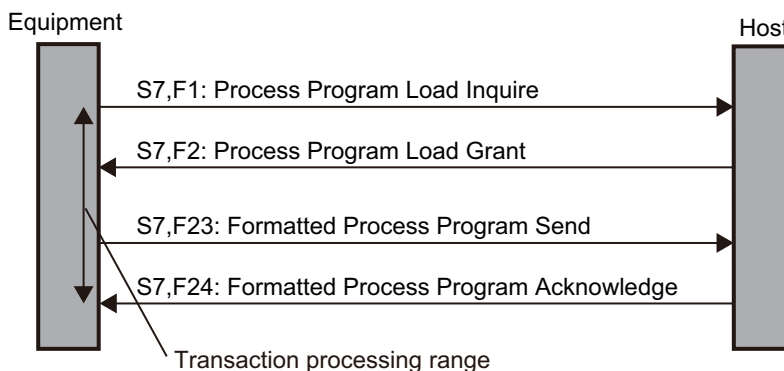

## Related System-defined Variables

Name	Meaning	Data type	Description
_GEM_BusyEquipFormattedPPUpload	Equipment-initiated Formatted Process Program Upload Transaction Processing Flag	BOOL	Gives the status of processing a transaction for an equipment-initiated formatted process program upload.*1 TRUE: Processing FALSE: Not processing
_GEM_EquipFormattedPPUploadRslt	Equipment-initiated Formatted Process Program Upload Results	_sGEM_RSLT	Gives the results of processing an equipment-initiated formatted process program upload. Refer to P. A-220 for details.
_GEM_ServiceStatus	GEM Service Status	_sGEM_SERVICE_STATUS	Gives the GEM Service status. Refer to P. A-212 for details.

\*1. This variable changes to TRUE when the instruction ends normally. It changes to FALSE when transaction processing is completed.

## Related User-defined Variables

### ● Equipment Management Variable

Name	Description	SECS/GEM Configurator setting
PPID Management Table	Used to manage PPID information inside the equipment. If the table contains NULL, no PPID information is registered.	Process Program

### ● Variables to Send Upload Request

Name	Description	SECS/GEM Configurator setting
Equipment-initiated Upload CCODE Table	Stores the formatted process program CCODEs to upload.	Process Program
Equipment-initiated Upload PPARM	Stores PPARM for the formatted process program to upload.	

## Related Error Codes

Error code	Name	Description
16#3820	Too Many Characters	The value of <i>PPID</i> , <i>MDLN</i> , or <i>SOFTREV</i> is outside of the valid range.
16#041D	Exceeded Simultaneous Instruction Executed Resources	The number of simultaneously executed GEM instructions exceeded the limit.
16#3822	Set to Disable	The instruction was executed when it was disabled on the SECS/GEM Configurator.
16#3821	Invalid Size	The value specified in <i>CCODENum</i> is larger than the number of array elements in the <i>Equipment-initiated Upload CCODE Table</i> user-defined variable.
16#3826	Undefined CCODE	A CCODE that was not defined in the SECS/GEM Configurator was specified.
16#3810	GEM Service Status in Initializing	The instruction was executed when the GEM Service status was Initializing.
16#3811	GEM Service Status in EQStarting	The instruction was executed when the GEM Service status was EQStarting.
16#3812	GEM Service Status in EQInitializing	The instruction was executed when the GEM Service status was EQInitializing.
16#3814	GEM Service Status in Stop	The instruction was executed when the GEM Service status was Stop.
16#3815	GEM Service Status in Error	The instruction was executed when the GEM Service status was Error.
16#3816	GEM Service Status in ShuttingDown	The instruction was executed when the GEM Service status was ShuttingDown.
16#3817	GEM Service Status in Shutdown	The instruction was executed when the GEM Service status was Shutdown.
16#3819	Multi-execution of Instructions	Transaction processing is not completed for a previous execution of the same instruction.

Error code	Name	Description
16#381B	Insufficient Transaction Resource	When the instruction was executed, the limit to the number of transactions that can be buffered had been reached.

### Precautions for Correct Use

- Before executing the instruction, confirm that all of the following conditions are met. If the instruction is executed when any of these conditions is not met, an error will occur and *Error* will change to TRUE.
  - a) *\_GEM\_ServiceStatus* must be *EQRun*.
  - b) *\_GEM\_BusyEquipFormattedPPUpload* must be TRUE.
- Access *\_GEM\_EquipFormattedPPUploadRslt* after *\_GEM\_BusyEquipFormattedPPUpload* changes from TRUE to FALSE.

### Application Procedure

Use the following procedure for this instruction.

- 1** Storing the Formatted Process Program to Upload  
 Store the formatted process program in the equipment to upload in the following variables.
  - Store the CCODEs in *Equipment-initiated Upload CCODE Table*.
  - Store the PPARM in *Equipment-initiated Upload PPARM*.
- 2** Executing the Formatted Process Program Upload  
 Do the following and then execute the instruction. The formatted process program will be uploaded to the host.
  - Store the PPARM for the formatted process program to upload in the *PPID* input variable.
  - Store the number of CCODEs in the formatted process program to upload in the *CCODENum* input variable.
- 3** Confirming the Result of the Formatted Process Program Upload  
 Check the result of the upload in *\_GEM\_EquipFormattedPPUploadRslt* after *\_GEM\_Busy-EquipFormattedPPUpload* changes to FALSE.

The following diagram shows the user program processing and data flow for the application procedure. The diagram shows an example of uploading the formatted process program with a PPID of Sample1 to the host. Numbers 1 to 3 in the diagram indicate the steps in the application procedure.

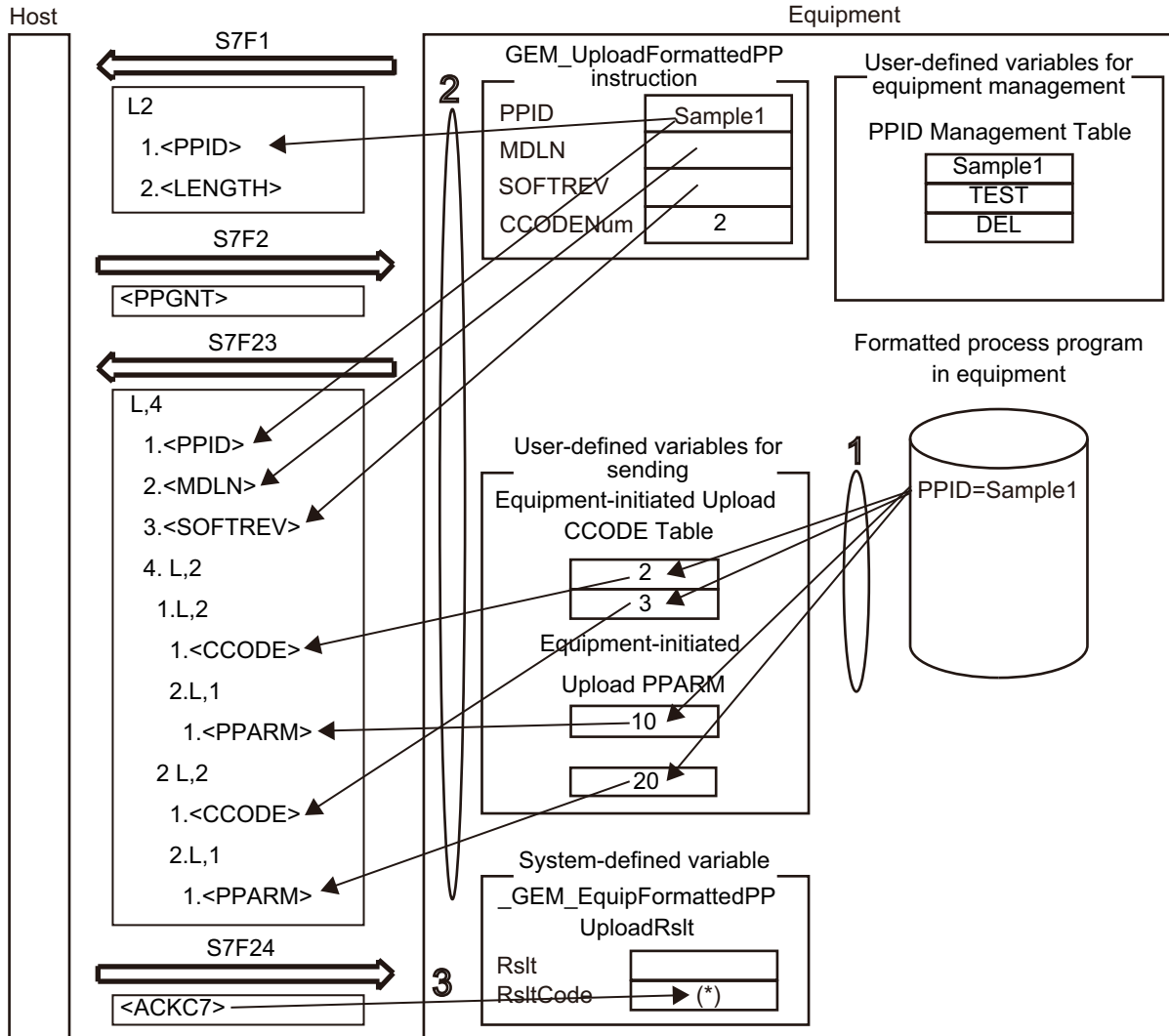

(\*) If the host does not allow loading in the Process Program Load Grant (S7,F2) from the host, *RsltCode* will contain PPGNT.

## Sample Programming

This sample uploads a formatted process program with a PPID of Sample1 to the host.

If the GEM Service status is EQRun and the *UploadFormattedPP\_Start* internal variable changes from FALSE to TRUE, the formatted process program is uploaded.

Destination information is stored in the Sample1 formatted process program.

The structure of PPARM is as follows and is registered for CCODE = 1.

L,3
1.<I2 X>
2.<I2 Y>
3.<I2 Z>

The structure of PPARM is defined as shown on the left.  
 X: X coordinate  
 Y: Y coordinate  
 Z: Z coordinate

For CCODE = 2, register the following.

L,2
1.<U2 LimitMin>
2.<U2 LimitMax>

The structure of PPARM is defined as shown on the left.  
 LimitMin: Lower limit  
 LimitMax: Upper limit

## SECS/GEM Configurator

First, the relevant variables are registered on the SECS/GEM Configurator.

Only the items that are related to the GEM\_UploadFormattedPP instruction are given in the following table.

### ● Process Program – Operation Settings

Item	Set value
Number of saved process programs	5
Link variable for PPID management table	PPID_TABLE

### ● Process Program – Formatted (1)

The formatted process program for the equipment-initiated upload is as follows:

CCODE	Description	Maximum number of PPARAMs	Format	Data size	Link variables	
1	Coordinates	3	I2	1	EQUIP_UPLOAD_FP-P_PPARAM1_TABLE	EQUIP_UPLOAD_FP-P_PPARAM1_NUMBER
2	Temperature	2	U2	1	EQUIP_UPLOAD_FP-P_PPARAM1_TABLE	EQUIP_UPLOAD_FP-P_PPARAM1_NUMBER

### ● Process Program - Formatted (2)

Item	Set value
Link variable for equipment-initiated upload - CCODE table	EQUIP_UPLOAD_FPP_CCODE_TABLE

Next, enter the programming on the Sysmac Studio.

## LD

Internal Variables	Variable	Data type	Initial value	Comment
	UploadFormattedPP_Start	BOOL	FALSE	Flag to start upload
	UploadFormattedPP_	GEM_Upload-FormattedPP		Instance of GEM_UploadFormattedPP instruction
	UploadFormattedPP_ WaitResp	BOOL	FALSE	Flag that indicates waiting for completion of upload
	UploadFormattedPP_ Complete	BOOL	FALSE	Flag that indicates completion of upload
	varFormattedUploadPPID	STRING[41]		ID of process program to upload
	varCCODENum	UINT	0	Number of CCODEs for formatted process program to upload

External Variables	Variable	Comment
	_GEM_ServiceStatus	GEM Service status
	_GEM_BusyEquipFormattedPPUpload	Equipment-initiated Formatted Process Program Upload Transaction Processing Flag
	_GEM_EquipInfo	Equipment information
	EQUIP_UPLOAD_FPP_PPARAM1_TABLE	Link variable for PPARAM table for CCODE = 1
	EQUIP_UPLOAD_FPP_PPARAM1_NUMBER	Link variable for PPARAM count for CCODE = 1
	EQUIP_UPLOAD_FPP_CCODE_TABLE	Link variable for equipment-initiated upload - CCODE table

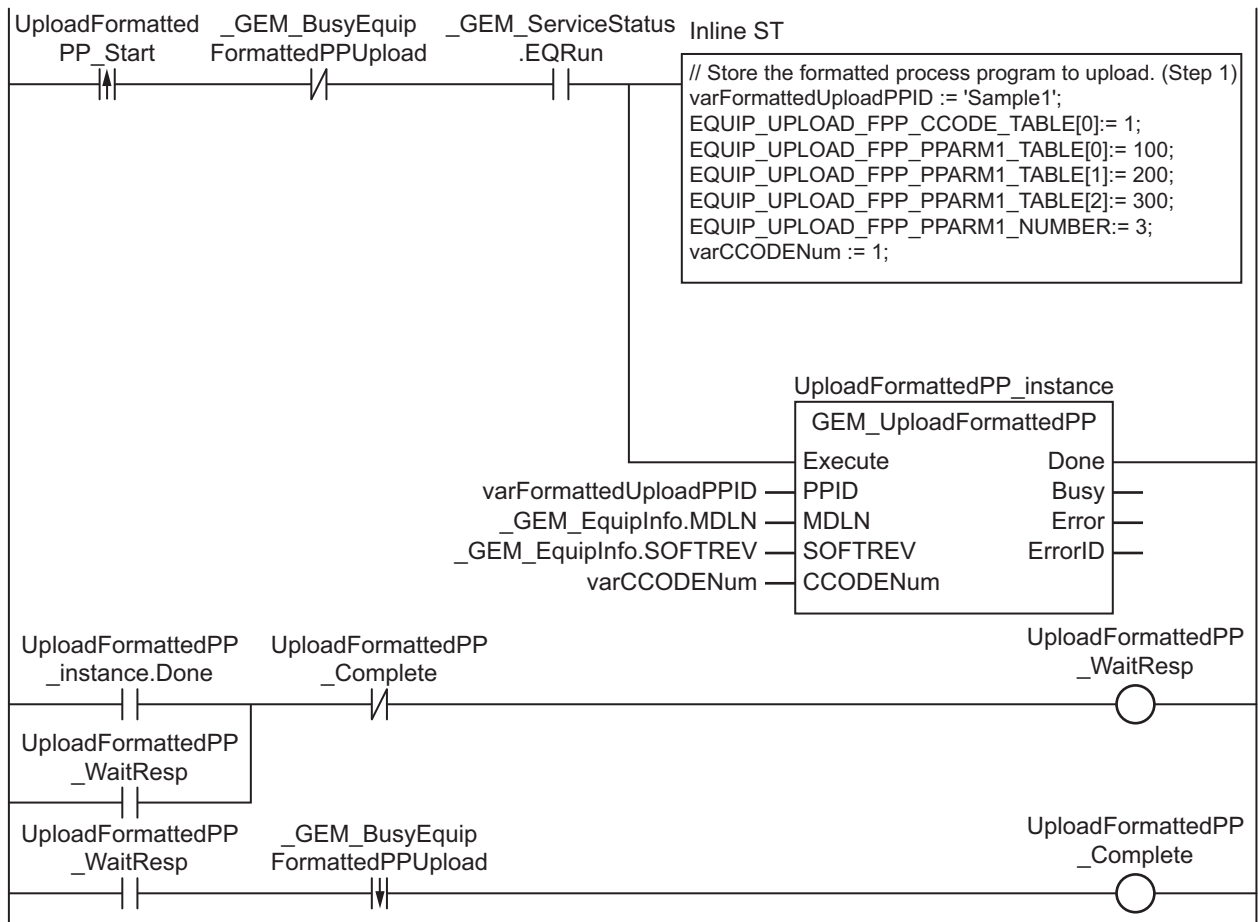

**ST**

Internal Variables	Variable	Data type	Initial value	Comment
	UploadFormattedPP_Start	BOOL	FALSE	Flag to start upload
	UploadFormattedPP_instance	GEM_UploadFormattedPP		Instance of GEM_UploadFormattedPP instruction
	UploadFormattedPP_WaitResp	BOOL	FALSE	Flag that indicates waiting for completion of upload
	UploadFormattedPP_Complete	BOOL	FALSE	Flag that indicates completion of upload
	varFormattedUploadPPID	STRING[41]		ID of process program to upload
	varCCODENum	UINT	0	Number of CCODEs for formatted process program to upload
	R_TRIG_instance	R_TRIG		Instance of R_TRIG instruction
	F_TRIG_instance	F_TRIG		Instance of F_TRIG instruction
	Trigger	BOOL	FALSE	Flag for FALSE to TRUE change in <i>UploadPP_Start</i>
				Flag for TRUE to FALSE change in <i>_GEM_BusyEquipFormattedPP Upload</i>
	Stage	INT	0	Program execution status

External Variables	Variable	Comment
	_GEM_ServiceStatus	GEM Service status
	_GEM_BusyEquipFormattedPPUpload	Equipment-initiated Formatted Process Program Upload Transaction Processing Flag
	_GEM_EquipInfo	Equipment information
	EQUIP_UPLOAD_FPP_PPARAM1_TABLE	Link variable for PPARAM table for CCODE = 1
	EQUIP_UPLOAD_FPP_PPARAM1_NUMBER	Link variable for PPARAM count for CCODE = 1
	EQUIP_UPLOAD_FPP_CCODE_TABLE	Link variable for equipment-initiated upload - CCODE table

```

CASE Stage Of
0: // Start
  R_TRIG_instance( UploadFormattedPP_Start, Trigger );
  IF((Trigger = TRUE)
    AND ( _GEM_ServiceStatus.EQRun = TRUE ) ) THEN
    // Store the formatted process program to upload. (Step 1)
    varFormattedUploadPPID := 'Sample1';
    EQUIP_UPLOAD_FPP_CCODE_TABLE[0] := 1;
    EQUIP_UPLOAD_FPP_PPARAM1_TABLE[0] := 100;
    EQUIP_UPLOAD_FPP_PPARAM1_TABLE[1] := 200;
    EQUIP_UPLOAD_FPP_PPARAM1_TABLE[2] := 300;
    EQUIP_UPLOAD_FPP_PPARAM1_NUMBER := 3;
    varCCODENum := 1;
    // Initialization
    UploadFormattedPP_instance( Execute:=FALSE,
      PPID:=varFormattedUploadPPID,
      MDLN:= _GEM_EquipInfo.MDLN,
      SOFTREV:= _GEM_EquipInfo.SOFTREV,
      CCODENum:=varCCODENum );
    Stage := 1;
  END_IF;

```

```

1: // Upload process program to host.
  UploadFormattedPP_instance( Execute:=TRUE,
    PPID:=varFormattedUploadPPID,
    MDLN:= _GEM_EquipInfo.MDLN,
    SOFTREV:= _GEM_EquipInfo.SOFTREV,
    CCONum:=varCCONum );
  IF(UploadFormattedPP_instance.Done = TRUE ) THEN
    Stage := 2;
  ELSIF(UploadFormattedPP_instance.Error = TRUE ) THEN
    Stage := 10;
  END_IF;
2:
  F_TRIG_instance( _GEM_BusyEquipFormattedPPUpload, Trigger );
  IF( Trigger = TRUE)THEN
    Stage := 10;
  END_IF;
10: // End
  Stage := 0;
END_CASE;

```



# GEM\_UploadPP

The GEM\_UploadPP instruction uploads a process program to the host.

Instruction	Name	FB/ FUN	Graphic expression	ST expression
GEM_UploadPP	Upload Process Program	FB		GEM_UploadPP_instance( Execute, PPID, LENGTH Done, Busy, Error, ErrorID);

## Variables

Name	Meaning	I/O	Description	Valid range	Unit	Default
PPID	Process program ID	Input	PPID to upload	121 bytes max. (including final NULL)*1	---	*2
LENGTH	Process program byte length		Process program (PPBODY) byte length	Depends on data type.		

\*1. The maximum number of characters is set on the SECS/GEM Configurator. The maximum number of bytes is the maximum number of characters including the final NULL character plus 1.

\*2. If you omit the input parameter, the default value is not applied. A building error will occur.

	Boolean	Bit strings				Integers						Real numbers		Times, durations, dates, and text strings						
	BOOL	BYTE	WORD	DWORD	LWORD	USINT	UINT	UDINT	ULINT	SINT	INT	DINT	LINT	REAL	LREAL	TIME	DATE	TOD	DT	STRING
PPID																				OK
LENGTH						OK	OK	OK		OK	OK	OK								

## Function

The GEM\_UploadPP instruction uploads a process program to the host. The following are required for the upload.

- Process program ID  
This is the PPID of the process program to upload.
- Process program byte length  
This is the byte length of the process program to upload.
- Process program  
This is the process program to upload.

Refer to the application procedure for this instruction for the processing to upload the process program.

## Additional Information

- This instruction uses the Equipment-initiated Process Program Upload scenario for the GEM Process Program Management capability.
- The message exchange between the equipment and host is given below. The SECS message exchange between the equipment and host is given below.

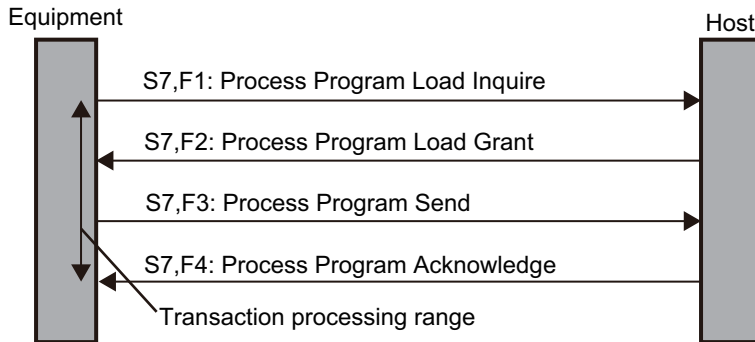

## Related System-defined Variables

Name	Meaning	Data type	Description
_GEM_BusyEquipPPUUpload	Equipment-initiated Process Program Upload Transaction Processing Flag	BOOL	Gives the status of processing a transaction for an equipment-initiated process program upload. <sup>*1</sup> TRUE: Processing FALSE: Not processing
_GEM_EquipPPUUploadRslt	Equipment-initiated Process Program Upload Result	_sGEM_RS LT	Gives the status of processing an equipment-initiated process program upload. Refer to P. A-221 for details.
_GEM_ServiceStatus	GEM Service Status	_sGEM_- SER- VICE_Stat US	Gives the GEM Service status. Refer to P. A-212 for details.

\*1. This variable changes to TRUE when the instruction ends normally. It changes to FALSE when transaction processing for the equipment-initiated process program upload is completed.

## Related User-defined Variables

### ● Equipment Management Variable

Name	Description	SECS/GEM Configurator setting
PPID Management Table	Used to manage PPID information inside the equipment. If the table contains NULL, no PPID information is registered.	Process Program

### ● Variable to Send Upload Request

Name	Description	SECS/GEM Configurator setting
Equipment-initiated Upload PP Data	Stores the process program data to upload.	Process Program – Unformatted

### Related Error Codes

Error code	Name	Description
16#3820	Too Many Characters	The value of the <i>PPID</i> input variable exceeded the size set on the SECS/GEM Configurator.
16#041D	Exceeded Simultaneous Instruction Executed Resources	The number of simultaneously executed GEM instructions exceeded the limit.
16#3822	Set to Disable	The instruction was executed when it was disabled on the SECS/GEM Configurator.
16#3821	Invalid Size	<p><i>LENGTH</i> that was specified for the <i>Upload PP Data</i> user-defined variable is not correct.</p> <ul style="list-style-type: none"> <li>• A value that is larger than the data size of <i>Upload PP Data</i> was specified.</li> <li>• A value that cannot be evenly divided by the size of the data type of <i>Upload PP Data</i> was specified.</li> </ul>
16#3810	GEM Service Status in Initializing	The instruction was executed when the GEM Service status was Initializing.
16#3811	GEM Service Status in EQStarting	The instruction was executed when the GEM Service status was EQStarting.
16#3812	GEM Service Status in EQInitializing	The instruction was executed when the GEM Service status was EQInitializing.
16#3814	GEM Service Status in Stop	The instruction was executed when the GEM Service status was Stop.
16#3815	GEM Service Status in Error	The instruction was executed when the GEM Service status was Error.
16#3816	GEM Service Status in ShuttingDown	The instruction was executed when the GEM Service status was ShuttingDown.
16#3817	GEM Service Status in Shutdown	The instruction was executed when the GEM Service status was Shutdown.
16#3819	Multi-execution of Instructions	Transaction processing is not completed for a previous execution of the same instruction.
16#381B	Insufficient Transaction Resource	When the instruction was executed, the limit to the number of transactions that can be buffered had been reached.

### Precautions for Correct Use

- Before executing the instruction, confirm that all of the following conditions are met. If the instruction is executed when any of these conditions is not met, an error will occur and *Error* will change to TRUE.
  - a) *\_GEM\_ServiceStatus* must be *EQRun*.
  - b) *\_GEM\_BusyEquipPPUpload* must be FALSE.
- Access *\_GEM\_EquipPPUploadRsIt* after *\_GEM\_BusyEquipPPUpload* changes from TRUE to FALSE.

### Application Procedure

Use the following procedure for this instruction.

- 1** Storing the Process Program to Upload  
Store the process program to upload in the equipment in *Equipment-initiated Upload PP Data*.
- 2** Executing the Process Program Upload  
Do the following and then execute the instruction. The process program will be uploaded to the host.
  - Store the PPID of the process program to upload in the *PPID* input variable.
  - Store the byte length of the process program to upload in the *LENGTH* input variable.
- 3** Confirming the Upload Result  
Check the result of the upload in *\_GEM\_EquipPPUploadRslt* after *\_GEM\_BusyEquipPPUpload* changes from TRUE to FALSE.

The following diagram shows the user program processing and data flow for the application procedure. The diagram shows an example of uploading to the host a process program with a PPID of *Sample1*. Numbers 1 to 3 in the diagram indicate the steps in the application procedure.

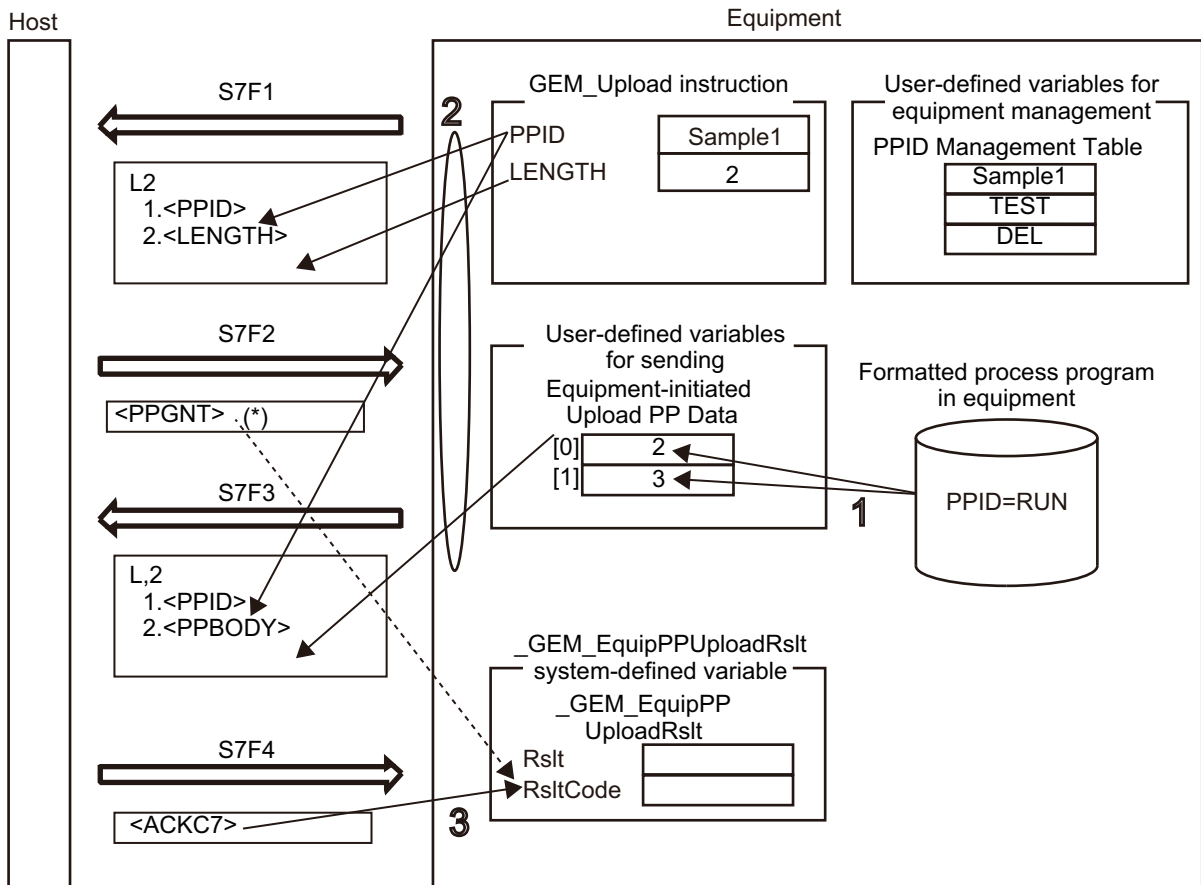

\*1. If the host does not allow loading in the Process Program Load Grant (S7,F2) from the host, *RsltCode* will contain PPGNT.

## Sample Programming

This sample uploads the process program with a PPID of Sample1 to the host.

If the GEM Service status is EQRun and the *UploadPP\_Start* internal variable changes from FALSE to TRUE, the process program is uploaded.

## SECS/GEM Configurator

First, the relevant variables are registered on the SECS/GEM Configurator.

Only the items that are related to the GEM\_UploadPP instruction are given in the following table.

### ● Process Program – Operation Settings

Item	Set value
Number of saved process programs	5
Link variable for PPID management table	PPID_TABLE

### ● Process Program – Unformatted

Item	Set value
PPBODY format	B
PPBODY data size	10
Link variable for equipment-initiated upload - PPBODY	EQUIP_UPLOAD_PPBODY

Next, enter the programming on the Sysmac Studio.

# LD

Internal Variables	Variable	Data type	Initial value	Comment
	UploadPP_Start	BOOL	FALSE	Flag to start upload
	UploadPP_instance	GEM_UploadPP		Instance of GEM_UploadPP instruction
	UpdatePP_WaitResp	BOOL	FALSE	Flag that indicates waiting for completion of upload
	UpdatePP_Complete	BOOL	FALSE	Flag that indicates completion of upload
	varUploadPPID	STRING[41]	NULL	PPID to upload
	varEquipUploadLENGTH	UINT	0	Process program byte length
	localPPData	ARRAY[0..9] OF BYTE	[16#01, 16#23, 16#45, 16#67, 16#89, 16#01, 16#23, 16#45, 16#67, 16#89]	Process program data to upload

External Variables	Variable	Comment
	_GEM_ServiceStatus	GEM Service status
	_GEM_BusyEquipPPUpload	Equipment-initiated Process Program Upload Transaction Processing Flag
	PPID_TABLE	Link variable for PPID management table
	EQUIP_UPLOAD_PPBODY	Link variable for equipment-initiated upload - PPBODY

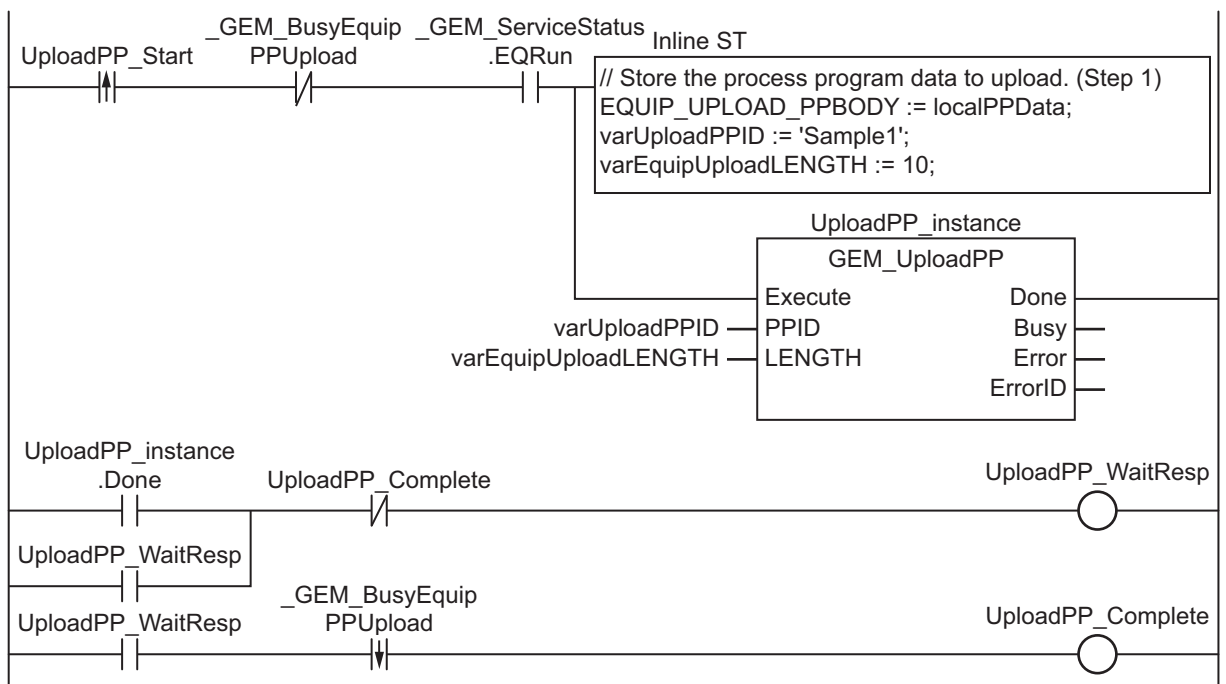

# ST

Internal Variables	Variable	Data type	Initial value	Comment
	UploadPP_Start	BOOL	FALSE	Flag to start upload
	UploadPP_instance	GEM_UploadPP		Instance of GEM_UploadPP instruction
	varUploadPPID	STRING[41]	NULL	PPID to upload
	varEquipUpload LENGTH	UINT	0	Process program byte length
	R_TRIG_instance	R_TRIG		Instance of R_TRIG instruction
	F_TRIG_instance	F_TRIG		Instance of F_TRIG instruction
	Trigger	BOOL	FALSE	Flag for FALSE to TRUE change in <i>UploadPP_Start</i> Flag for TRUE to FALSE change in <i>_GEM_BusyEquipPPUpload</i>
	Stage	INT	0	Program execution status
	localPPData	ARRAY[0..9] OF BYTE	[16#01, 16#23, 16#45, 16#67, 16#89, 16#01, 16#23, 16#45, 16#67, 16#89]	Process program data to upload

External Variables	Variable	Comment
	_GEM_ServiceStatus	GEM Service status
	_GEM_BusyEquipPPUpload	Equipment-initiated Process Program Upload Transaction Processing Flag
	PPID_TABLE	Link variable for PPID management table
	EQUIP_UPLOAD_PPBODY	Link variable for equipment-initiated upload - PPBODY

```

CASE Stage Of
0: // Start
  R_TRIG_instance( UploadPP_Start, Trigger );
  IF((Trigger = TRUE) AND ( _GEM_ServiceStatus.EQRun = TRUE ) ) THEN
    // Store the process program data to upload. (Step 1)
    EQUIP_UPLOAD_PPBODY := localPPData;
    varUploadPPID := 'Sample1';
    // Initialization
    UploadPP_instance( Execute:=FALSE, PPID:=varUploadPPID, LENGTH:=varEquipUp-
loadLENGTH );
    Stage := 1;
  END_IF;
1: // Upload process program to host.
  UploadPP_instance( Execute:=TRUE, PPID:=varUploadPPID, LENGTH:=varEquipUp-
loadLENGTH );
  IF( UploadPP_instance.Done = TRUE ) THEN
    Stage := 2;
  ELSIF( UploadPP_instance.Error = TRUE ) THEN
    // Add error processing as required.
    Stage := 10;
  END_IF;
2:
  F_TRIG_instance( _GEM_BusyEquipPPUpload, Trigger );
    
```

```
IF( Trigger = TRUE) THEN
  Stage := 10;
END_IF;
10: // End
  Stage := 0;
END_CASE;
```



# GEM\_AckFormattedPPDownload

The GEM\_AckFormattedPPDownload instruction sends the accept/reject result in reply to a request for a formatted process program download from the host.

Instruction	Name	FB/FUN	Graphic expression	ST expression
GEM_AckFormattedPPDownload	Acknowledge Formatted Process Program Download	FB		GEM_AckFormattedPPDownload_instance(Execute, PPID, ACKC7, Done, Busy, ErrorID);

## Variables

Name	Meaning	I/O	Description	Valid range	Unit	Default
PPID	Process program ID	Input	PPID that was downloaded*1	121 bytes max. (including final NULL) *2	---	---
ACKC7	Acknowledge Code		Accept/reject result 16#00: Accepted 16#01: Permission not granted 16#02: Length error 16#03: Matrix overflow 16#04: PPID not found 16#05: Mode unsupported 16#06 to 16#3F: Other errors	16#00 to 16#3F		

\*1. It is not necessary to set an input variable. The PPID of the downloaded formatted process program is automatically input.

\*2. The maximum number of characters is set on the SECS/GEM Configurator. The maximum number of bytes is the maximum number of characters including the final NULL character plus 1.

	Boolean	Bit strings				Integers							Real numbers		Times, durations, dates, and text strings					
	BOOL	BYTE	WORD	DWORD	LWORD	USINT	UINT	UDINT	ULINT	SINT	INT	DINT	LINT	REAL	LREAL	TIME	DATE	TOD	DT	STRING
PPID																				OK
ACKC7		OK																		

## Function

The GEM\_AckFormattedPPDownload instruction sends the accept/reject result in reply to a request for a formatted process program download from the host. The following are required for the reply.

- Acknowledge code

Use the following criteria to determine if the downloaded formatted process program is accepted or rejected.

- (a) Can the formatted process program be accepted?
- (b) Is the formatted process program valid?
- (c) Was the formatted process program saved?

Refer to the application procedure for this instruction for the processing to send a reply with the accept/reject result.

## Additional Information

- This instruction uses the Host-initiated Formatted Process Program Download scenario for the GEM Process Program Management capability.
- A SECS message is sent if this instruction is executed and execution ends normally. The SECS message exchange between the equipment and host is given below.

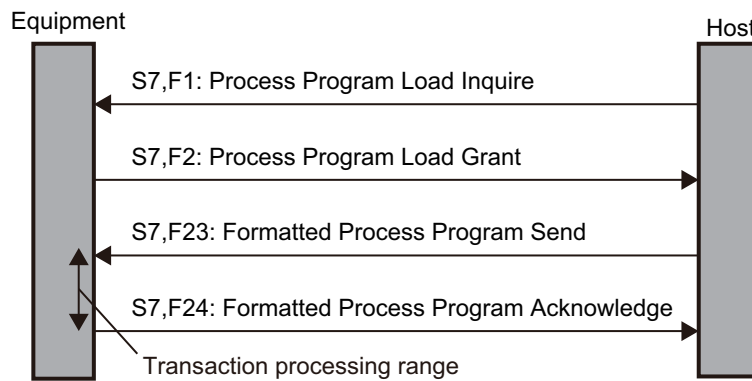

## Related System-defined Variables

Name	Meaning	Data type	Description
_GEM_BusyHostFormattedPPDownload	Host-initiated Formatted Process Program Download Transaction Processing Flag	BOOL	Gives the status of processing a transaction for a host-initiated formatted process program download.*1 TRUE: Processing FALSE: Not processing
_GEM_Interlock_PP	Process Program Interlock	BOOL	Specifies whether to prohibit process program deletion requests and upload/download requests from the host. TRUE: Prohibited FALSE: Granted
_GEM_ServiceStatus	GEM Service Status	_sGEM_SER-VICE_STA-TUS	Gives the GEM Service status. Refer to P. A-212 for details.

\*1. When a Formatted Process Program Send (S7,F23) is received from the host, this variable changes to TRUE. It will change to FALSE when execution of the instruction is completed normally.

## Related User-defined Variables

### ● Equipment Management Variable

Name	Description	SECS/GEM Configurator setting
PPID Management Table	Used to manage PPID information inside the equipment. If the table contains NULL, no PPID information is registered.	Process Program

### ● Variables to Receive Download Request

Name	Description	SECS/GEM Configurator setting
Host-initiated Download Formatted PPID	Stores the PPID for the formatted process program downloaded from the host.	Process Program
Host-initiated Download MDLN	Stores the MDLN for the formatted process program downloaded from the host.	
Host-initiated Download SOFTREV	Stores the SOFTREV for the formatted process program downloaded from the host.	
Host-initiated Download Number of CCODEs	Stores the number of CCODEs for the formatted process program downloaded from the host.	
Host-initiated Download CCODE Table	Stores the CCODEs for the formatted process program downloaded from the host.	
Host-initiated Download PPARAM Value	Stores the PPARAM for the formatted process program downloaded from the host.	

## Related Error Codes

Error code	Name	Description
16#3833	ACKC7 Out of Range	The value of the ACKC7 input variable is outside of the valid range.
16#041D	Exceeded Simultaneous Instruction Executed Resources	The number of simultaneously executed GEM instructions exceeded the limit.
16#3810	GEM Service Status in Initializing	The instruction was executed when the GEM Service status was Initializing.
16#3811	GEM Service Status in EQStarting	The instruction was executed when the GEM Service status was EQStarting.
16#3812	GEM Service Status in EQInitializing	The instruction was executed when the GEM Service status was EQInitializing.
16#3814	GEM Service Status in Stop	The instruction was executed when the GEM Service status was Stop.
16#3815	GEM Service Status in Error	The instruction was executed when the GEM Service status was Error.
16#3816	GEM Service Status in ShuttingDown	The instruction was executed when the GEM Service status was ShuttingDown.
16#3817	GEM Service Status in Shutdown	The instruction was executed when the GEM Service status was Shutdown.
16#3818	No Message Received	The instruction was executed when a formatted process program download was not received.

## Precautions for Correct Use

- Before executing the instruction, confirm that all of the following conditions are met. If the instruction is executed when any of these conditions is not met, an error will occur and *Error* will change to TRUE.
  - a) *\_GEM\_ServiceStatus* must be *EQRun*.
  - a) The value specified in the *ACKC7* input variable must be within the valid range.
  - b) *\_GEM\_BusyHostFormattedPPDownload* must be TRUE.
- In the following cases, *\_GEM\_BusyHostFormattedPPDownload* does not change to TRUE even if a Formatted Process Program Send (S7,F23) is received.
  - a) The data type of the PPID set for the process program on the SECS/GEM Configurator and the data type of the PPID for the formatted process program received from the host are different.
  - b) *LENGTH* in the Process Program Load Inquire (S7,F1) received from the host is larger than the size that the GEM Service can receive.
  - c) The PPID of the downloaded formatted process program is new and there is no space in *PPID Management Table*.
  - d) *\_GEM\_Interlock\_PP* is TRUE.
  - e) Formatted Process Program Send (S7,F23) is disabled in the GEM message settings on the SECS/GEM Configurator.
- An error does not occur when you execute the instruction even if you specify a PPID in the *PPID* input variable that is different from the formatted process program PPID received from the host.

## Application Procedure

Use the following procedure for this instruction.

- 1** Detecting the Formatted Process Program Download
 

Confirm that *\_GEM\_BusyHostFormattedPPDownload* changes from FALSE to TRUE.

The downloaded formatted process program is stored in the following variables.

  - Host-initiated Download Formatted PPID
  - Host-initiated Download MDLN
  - Host-initiated Download SOFTREV
  - Host-initiated Download Number of CCODEs
  - Host-initiated Download CCODE Table
  - Host-initiated Download PPARAM Value
- 2** Determining Acceptance/Rejection of Formatted Process Program
 

If the download can be accepted, the acknowledge code is 16#00.

If the download cannot be accepted, the acknowledge code is 16#05.
- 3** Determining the Validity of the Formatted Process Program
 

If the download can be accepted, determine the validity of the formatted process program that was downloaded. Examples of the criteria to determine validity are given below.

  - Are the values in *Host-initiated Download MDLN* and *\_GEM\_EquipInfo.MDLN* the same ?
  - Are the values in *Host-initiated Download SOFTREV* and *\_GEM\_EquipInfo.SOFTREV* the same?
  - Is the value of *Host-initiated Download PPARAM* inside of the valid range?

If the criteria are met, the acknowledge code is 16#00.

If the criteria are not met, the acknowledge code is 16#01.

If the validity determination result is to be sent to the host, you must store the values in the required user-defined variables to execute the `GEM_SendPPVerify` instruction in step 6.

Refer to the related user-defined variables for the `GEM_SendPPVerify` on page A-151 for details on the required user-defined variables.

#### **4** Saving the Formatted Process Program

If the formatted process program is valid, save the formatted process program that was downloaded in the equipment. If required, confirm that the formatted process program was saved.

If it was saved, the acknowledge code is 16#00.

If it was not saved, the acknowledge code is 16#01.

If it was saved and the PPID in *Host-initiated Download Formatted PPID* is not in *PPID Management Table*, add it to *PPID Management Table*. If it is already in *PPID Management Table*, it does not need to be added.

#### **5** Sending the Accept/Reject Result for the Formatted Process Program

Specify the acknowledge code from steps 2 to 4 in the `ACKC7` input variable and execute the instruction. The accept/reject result for the formatted process program is sent to the host as the reply.

#### **6** Sending the Result of Confirming the Validity of the Formatted Process Program

Store the number of invalid PPARM values from the validity confirmation results in step 3 in the `ErrorNum` input variable and execute the `GEM_SendPPVerify` instruction. The formatted process program verification results are sent to the host.

The following diagram shows the user program processing and data flow for the application procedure.

The diagram shows an example of a request from the host to download the formatted process program with a PPID of *RUN*. Numbers 1 to 6 in the diagram indicate the steps in the application procedure.

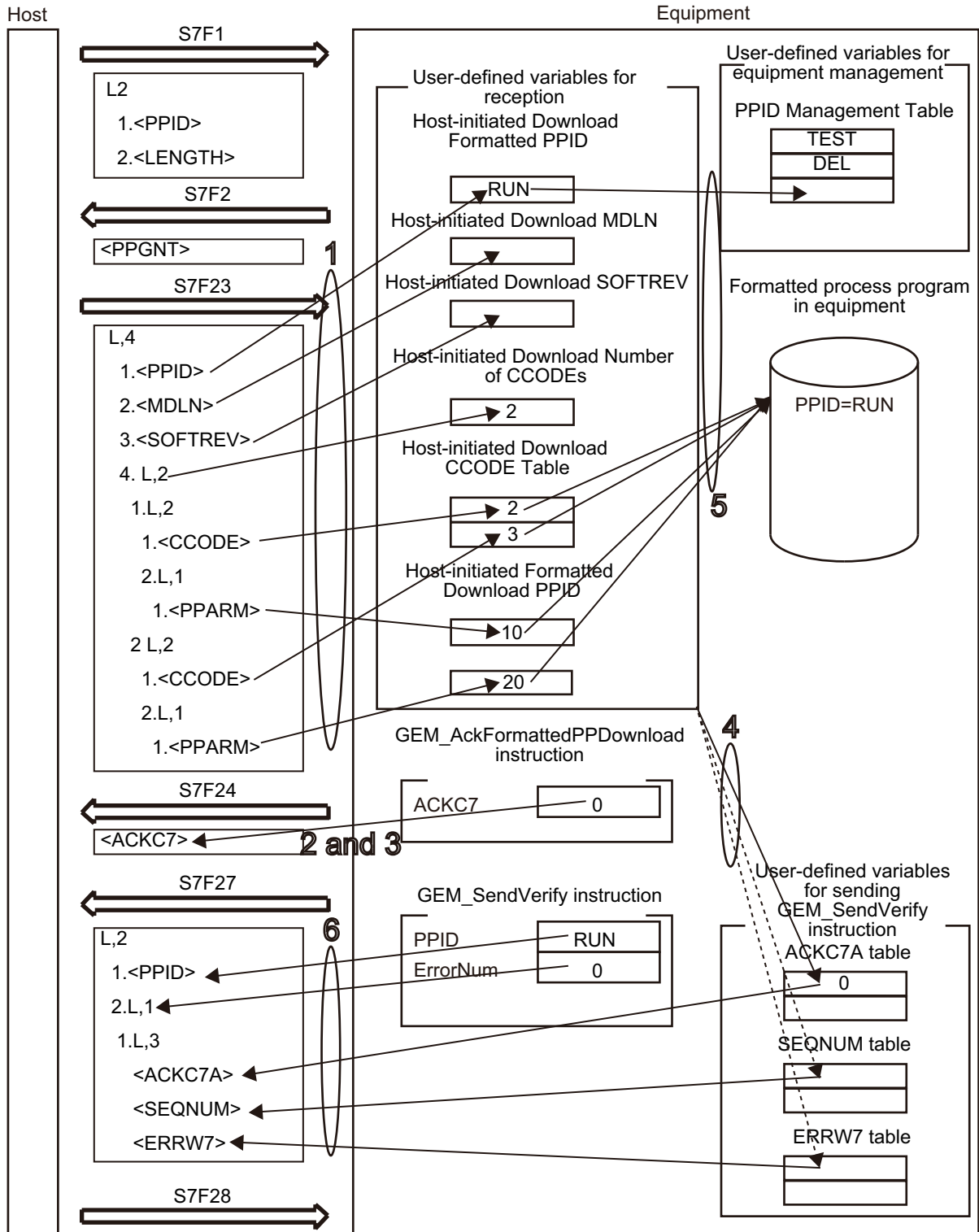

## Sample Programming

This sample sends the accept/reject result in reply to a request for a formatted process program download from the host.

The downloaded formatted process program that is downloaded from the host is Sample1.

Destination information is stored in the Sample1 formatted process program.

The structure of PPARM is as follows and is registered for CCODE = 1.

L,3 1.<I2 X> 2.<I2 Y> 3.<I2 Z>	The structure of PPARM is defined as shown on the left. X: X coordinate Y: Y coordinate Z: Z coordinate
---	--

For CCODE = 2, register the following.

L,2 1.<U2 LimitMin> 2.<U2 LimitMax>	The structure of PPARM is defined as shown on the left. LimitMin: Lower limit LimitMax: Upper limit
---	---

## SECS/GEM Configurator

First, the relevant variables are registered on the SECS/GEM Configurator.

Only the items that are related to the GEM\_AckFormattedPPDownload instruction are given in the following table.

### ● Process Program – Operation Settings

Item	Set value
Number of saved process programs	5
Link variable for PPID management table	PPID_TABLE

### ● Process Program – Formatted (1)

The formatted process program for the host-initiated upload is as follows:

CCODE	Description	Maximum number of PPARAMs	Format	Data size	Link variables	
1	Coordinates	3	I2	1	HOST__DOWN-LOAD_FPP_P-PARM1_TABLE	HOST__DOWN-LOAD_FPP_P-PARM1_NUMBER
2	Temperature	2	U2	1	HOST__DOWN-LOAD_FPP_PPARAM2_TABLE	HOST__DOWN-LOAD_FPP_PPARAM2_NUMBER

### ● Process Programs – Formatted (2)

Item	Set value
Link variable for host-initiated download - PPID	HOST_DOWNLOAD_FPP_PPID
Link variable for host-initiated download - MDLN	HOST_DOWNLOAD_FPP_MDLN
Link variable for host-initiated download - SOFTREV	HOST_DOWNLOAD_FPP_SOFTREV
Link variable for host-initiated download - CCODE count	HOST_DOWNLOAD_FPP_CCODE_NUMBER
Link variable for host-initiated download - CCODE table	HOST_DOWNLOAD_FPP_CCODE_TABLE

Item	Set value
Link variable for verification result- ACKC7A table	FPP_VERIFY_ACKC7A_TABLE
Link variable for verification result - SEQNUM table	FPP_VERIFY_SEQNUM_TABLE
Link variable for verification result - ERRW7 table	FPP_VERIFY_ERRW7_TABLE

Next, enter the programming on the Sysmac Studio.

## LD

Internal Variables	Variable	Data type	Initial value	Comment
	varAckFormattedPPDownloadACKC7	BYTE	FALSE	Download accept/reject result
	AckFormattedPPDownload_instance	GEM_AckFormattedPPDownload		Instance of GEM_AckFormattedPPDownload instruction
	SendPPVerify_instance	GEM_SendPPVerify		Instance of GEM_SendPPVerify instruction
	varVerifyErrorNum	UINT	0	Number of errors in verification results
	localPPARM	ARRAY[0..2] OF INT		PPARM value of formatted process program to save in equipment
	localPPARMNumber	INT	0	Number of PPARMs for formatted process program to save in equipment

External Variables	Variable	Comment
	_GEM_ServiceStatus	GEM Service status
	_GEM_BusyHostFormattedPPDownload	Host-initiated Formatted Process Program Download Transaction Processing Flag
	HOST_DOWNLOAD_FPP_PPID	Link variable for host-initiated download - PPID
	HOST_DOWNLOAD_FPP_PPARM1_TABLE	Link variable for PPARM table for CCODE = 1
	HOST_DOWNLOAD_FPP_PPARM1_NUMBER	Link variable for PPARM count for CCODE = 1



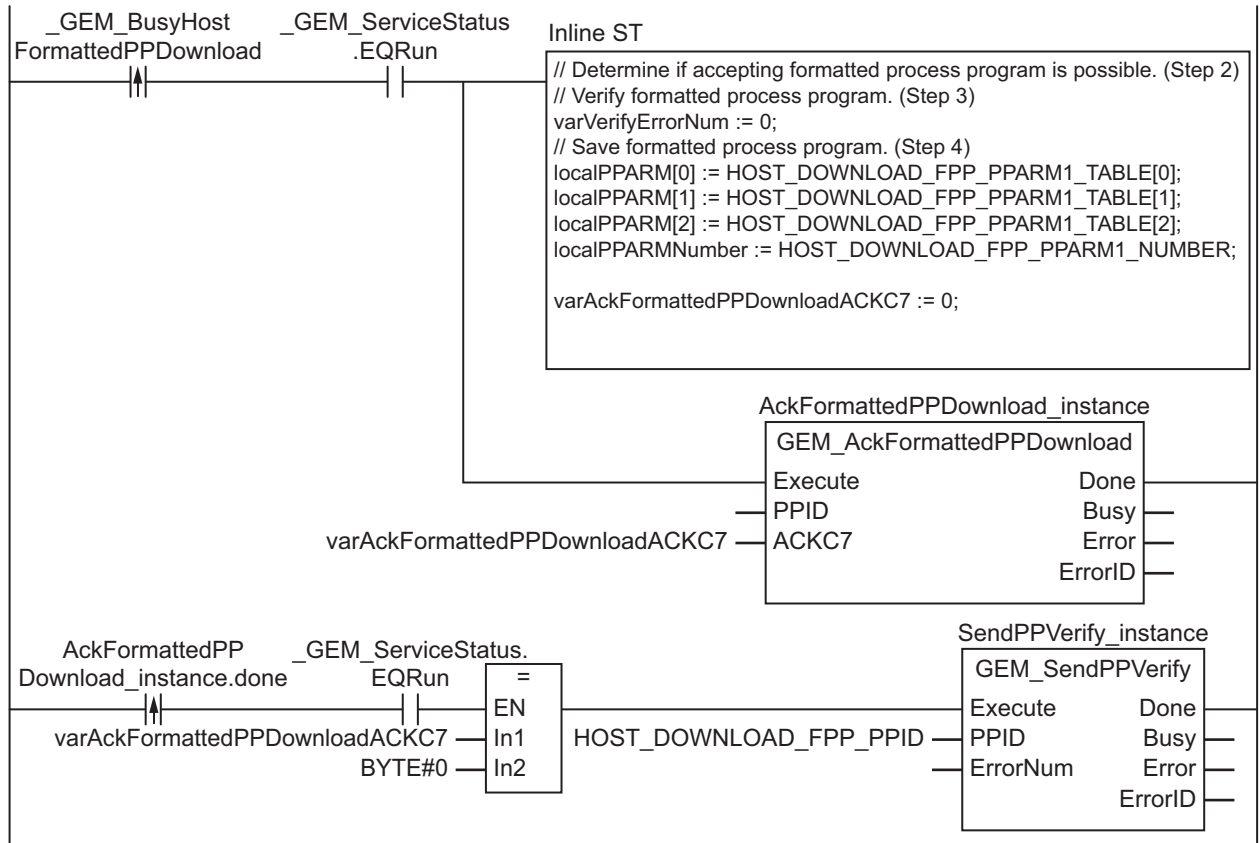

Note In inline ST step 3, add the programming to verify the formatted process program as required.

Note In inline ST step 4, add the programming to add the PPID to the PPID Management Table.

## ST

Internal Variables	Variable	Data type	Initial value	Comment
	varAckFormattedPPDownloadACKC7	BYTE	0	Download accept/reject result
	AckFormattedPPDownload_instance	GEM_AckFormattedPPDownload		Instance of GEM_AckFormattedPPDownload instruction
	SendPPVerify_instance	GEM_SendPPVerify		Instance of GEM_SendPPVerify instruction
	R_TRIG_instance	R_TRIG		Instance of R_TRIG instruction
	Trigger	BOOL	FALSE	Flag for FALSE to TRUE change in <i>_GEM_BusyHostFormattedPPDownload</i>
	Stage	INT	0	Program execution status
	varVerifyErrorNum	UINT	0	Number of errors in verification results
	localPPARM	ARRAY[0..2] OF INT		PPARM value of formatted process program to save in equipment
	localPPARMNumber	INT	0	Number of PPARMs for formatted process program to save in equipment

External Variables	Variable	Comment
	<u>_GEM_ServiceStatus</u>	GEM Service status
	<u>_GEM_BusyHostFormattedPPDownload</u>	Host-initiated Formatted Process Program Download Transaction Processing Flag
	<u>HOST_DOWNLOAD_FPP_PPID</u>	Link variable for host-initiated download - PPID
	<u>HOST_DOWNLOAD_FPP_PPARM1_TABLE</u>	Link variable for PPARAM table for CCODE = 1
	<u>HOST_DOWNLOAD_FPP_PPARM1_NUMBER</u>	Link variable for PPARAM count for CCODE = 1

```

CASE Stage Of
0: // Detect reception of formatted process program download. (Step 1)
  R_TRIG_instance( _GEM_BusyHostFormattedPPDownload, Trigger );
  IF( Trigger = TRUE ) THEN
    // Determine if accepting formatted process program is possible. (Step 2)
    // Verify formatted process program. (Step 3)
    varVerifyErrorNum := 0;
    // Save formatted process program. (Step 4)
    localPPARM[0] := HOST_DOWNLOAD_FPP_PPARM1_TABLE[0];
    localPPARM[1] := HOST_DOWNLOAD_FPP_PPARM1_TABLE[1];
    localPPARM[2] := HOST_DOWNLOAD_FPP_PPARM1_TABLE[2];
    localPPARMNumber := HOST_DOWNLOAD_FPP_PPARM1_NUMBER;
    varAckFormattedPPDownloadACKC7:=BYTE#0;
    varVerifyErrorNum:=0;
    // Initialization
    AckFormattedPPDownload_instance( Execute:=FALSE, ACKC7:= varAckFormattedPPDownloadACKC7);
    SendPPVerify_instance( PPID:= HOST_DOWNLOAD_FPP_PPID, ErrorNum:=varVerifyErrorNum );
    Stage:=1;
  END_IF;
1: // Send accept/reject result for formatted process program. (Step 5)
  AckFormattedPPDownload_instance( Execute:=TRUE, ACKC7:= varAckFormattedPPDownloadACKC7);
  IF( AckFormattedPPDownload_instance.Done = TRUE ) THEN
    Stage := 2;
  ELSIF( AckFormattedPPDownload_instance.Error = TRUE ) THEN
    Stage := 10;
  END_IF;
2: // Send result of verifying formatted process program. (Step 6)
  SendPPVerify_instance( PPID:= HOST_DOWNLOAD_FPP_PPID, ErrorNum:=varVerifyErrorNum );
  IF( SendPPVerify_instance.Done = TRUE ) THEN
    Stage := 10;
  ELSIF( SendPPVerify_instance.Error = TRUE ) THEN
    Stage := 10;
  END_IF;
10: // End
  Stage := 0;
END_CASE;

```

# GEM\_AckPPDownload

The GEM\_AckPPDownload instruction sends the accept/reject result in reply to a request for a process program download from the host.

Instruction	Name	FB/ FUN	Graphic expression	ST expression
GEM_AckPPDownload	Acknowledge Process Program Download	FB		GEM_AckPPDownload_instance( Execute, PPID, ACKC7, Done, Busy, Error, ErrorID);

## Variables

Name	Meaning	I/O	Description	Valid range	Unit	Default
PPID	Process program ID	Input	PPID that was downloaded*1	121 bytes max. (including final NULL)*2	---	---
ACKC7	Acknowledge code		Accept/reject result 16#00: Accepted 16#0401: Permission not granted 16#02: Length error 16#03: Matrix overflow 16#04: PPID not found 16#05: Mode unsupported 16#06 to 16#3F: Other errors	16#00 to 16#3F		16#00

\*1. It is not necessary to set an input variable. The PPID of the downloaded process program is automatically input.

\*2. The maximum number of characters is set on the SECS/GEM Configurator. The maximum number of bytes is the maximum number of characters including the final NULL character plus 1.

	Boolean	Bit strings				Integers							Real numbers		Times, durations, dates, and text strings					
	BOOL	BYTE	WORD	DWORD	LWORD	USINT	UINT	UDINT	ULINT	SINT	INT	DINT	LINT	REAL	LREAL	TIME	DATE	TOD	DT	STRING
PPID																				OK
ACKC7		OK																		

## Function

The GEM\_AckPPDownload instruction sends the accept/reject result in reply to a request for a process program download from the host. The following are required for the reply.

- Acknowledge Code

This is the accept/reject result for the downloaded formatted process program.

Refer to the application procedure for this instruction for the processing to send a reply with the accept/reject result.

## Additional Information

- This instruction uses the Host-initiated Process Program Download scenario for the GEM Process Program Management capability.
- A SECS message is sent if this instruction is executed and execution ends normally. The SECS message exchange between the equipment and host is given below.

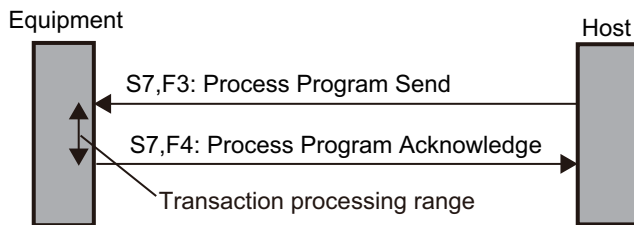

## Related System-defined Variables

Name	Meaning	Data type	Description
_GEM_BusyHostPDownload	Host-initiated Process Program Download Transaction Processing Flag	BOOL	Gives the status of processing a transaction for a host-initiated process program download. *1 TRUE: Processing FALSE: Not processing
_GEM_Interlock_PP	Process Program Interlock	BOOL	Specifies whether to prohibit process program deletion requests and upload/download requests from the host. TRUE: Prohibited FALSE: Granted
_GEM_ServiceStatus	GEM Service Status	_sGEM_SERVICE_STATUS	Gives the GEM Service status. Refer to P. A-212 for details.

\*1. This variable changes to TRUE when a Process Program Send (S7,F3) is received from the host. It will change to FALSE when execution of the instruction is completed normally.

## Related User-defined Variables

### ● Equipment Management Variable

Name	Description	SECS/GEM Configurator setting
PPID Management Table	Used to manage PPID information inside the equipment. If the table contains NULL, no PPID information is registered.	Process Program

### ● Variables to Receive Download Request

Name	Description	SECS/GEM Configurator setting
Host-initiated Download PPID	Stores the process program PPID for the host-initiated download.	Process Program – Unformatted
Host-initiated Download LENGTH	Stores the LENGTH of the process program for the host-initiated download.	
Host-initiated Download PPBODY	Stores the PPBODY of the process program for the host-initiated download.	

## Related Error Codes

Error code	Name	Description
16#3833	ACKC7 Out of Range	The value of the ACKC7 input variable is outside of the valid range.
16#041D	Exceeded Simultaneous Instruction Executed Resources	The number of simultaneously executed GEM instructions exceeded the limit.
16#3810	GEM Service Status in Initializing	The instruction was executed when the GEM Service status was Initializing.
16#3811	GEM Service Status in EQStarting	The instruction was executed when the GEM Service status was EQStarting.
16#3812	GEM Service Status in EQInitializing	The instruction was executed when the GEM Service status was EQInitializing.
16#3814	GEM Service Status in Stop	The instruction was executed when the GEM Service status was Stop.
16#3815	GEM Service Status in Error	The instruction was executed when the GEM Service status was Error.
16#3816	GEM Service Status in ShuttingDown	The instruction was executed when the GEM Service status was ShuttingDown.
16#3817	GEM Service Status in Shutdown	The instruction was executed when the GEM Service status was Shutdown.
16#3818	No Message Received	The instruction was executed when a process program download request was not received.

## Precautions for Correct Use

- Before executing the instruction, confirm that all of the following conditions are met. If the instruction is executed when any of these conditions is not met, an error will occur and *Error* will change to TRUE.
  - a) *\_GEM\_ServiceStatus* must be *EQRun*.
  - b) *\_GEM\_BusyHostPPDownload* must be TRUE.
- In the following cases, *\_GEM\_BusyHostPPDownload* does not change to TRUE even if a Process Program Send (S7,F3) is received.
  - a) The data types of the PPID set on the SECS/GEM Configurator and the PPID for the process program received from the host are different.
  - b) The LENGTH of the process program received from the host is larger than the size of PPBODY set on the SECS/GEM Configurator.
  - c) The PPID of the downloaded process program is new and there is no space in *PPID Management Table*.
  - d) *\_GEM\_Interlock\_PP* is TRUE.
  - e) Process Program Send (S7,F3) is disabled in the message settings on the SECS/GEM Configurator.
- An error does not occur even if you specify a different PPID in the *PPID* input variable from the one that was received.
- An error does not occur when you execute the instruction even if you specify a different PPID in the *PPID* input variable compared with the Host-initiated Download PPID.

## Application Procedure

Use the following procedure for this instruction.

### 1 Detecting the Process Program Download

Confirm that *\_GEM\_BusyHostPPDownload* changes from FALSE to TRUE.  
The downloaded process program is stored in the following variables.

- Host-initiated Download PPID
- Host-initiated Download LENGTH
- Host-initiated Download PPBODY

### 2 Determining Acceptance/Rejection of Downloaded Process Program

If the download can be accepted, the acknowledge code is 16#00.

If the download cannot be accepted, the acknowledge code is 16#05.

### 3 Saving the Process Program

If the download can be accepted, save the downloaded process program in the equipment. If required, confirm that the process program was saved.

If it was saved, the acknowledge code is 16#00.

If it was not saved, the acknowledge code is 16#01.

If it was saved and the PPID in *Host-initiated Download PPID* is not in *PPID Management Table*, add it to *PPID Management Table*. If it is already in *PPID Management Table*, it does not need to be added.

### 4 Sending the Accept/Reject Result for the Process Program

Specify the acknowledge code from steps 2 and 3 in the *ACKC7* input variable and execute the instruction. The process program accept/reject result is sent to the host.

The following diagram shows the user program processing and data flow for the application procedure. The diagram shows an example of a request from the host to download the process program with a PPID of *RUN*. Numbers 1 to 4 in the diagram indicate the steps in the application procedure.

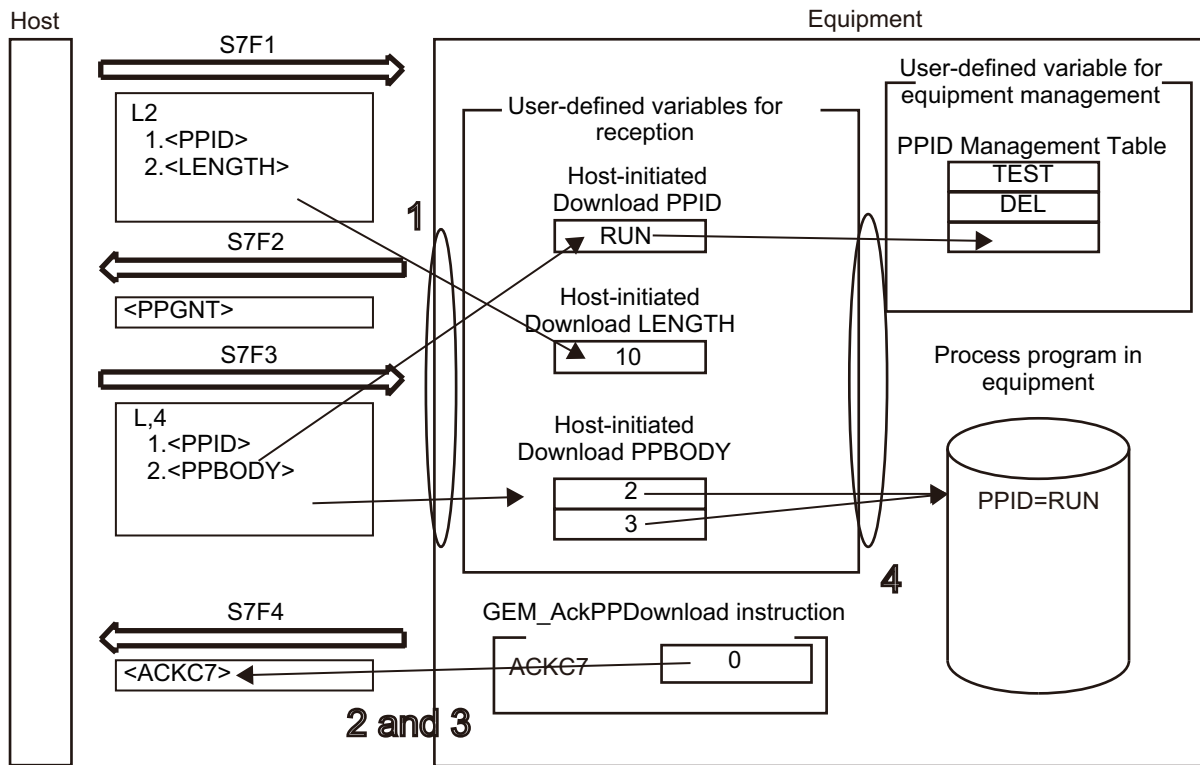

## Sample Programming

This sample sends the accept/reject result in reply to a request for a process program download from the host.

## SECS/GEM Configurator

First, the relevant variables are registered on the SECS/GEM Configurator.

Only the items that are related to the GEM\_AckPPDownload instruction are given in the following table.

### ● Process Program – Operation Settings

Item	Set value
Number of saved process programs	5
Link variable for PPID management table	PPID_TABLE

### ● Process Program – Unformatted

Item	Set value
PPBODY format	B
PPBODY data size	10
Link variable for host-initiated download - PPID	HOST_DOWNLOAD_PPID
Link variable for host-initiated download - LENGTH	HOST_DOWNLOAD_LENGTH
Link variable for host-initiated download - PPBODY	HOST_DOWNLOAD_PPBODY

Next, enter the programming on the Sysmac Studio.

## LD

Internal Variables	Variable	Data type	Initial value	Comment
	varAckPPDownloadACKC7	BYTE	0	Download accept/reject result
	AckPPDownload_instance	GEM_AckPPDownload		Instance of GEM_AckPPDownload instruction
	localPPData	ARRAY[0..9] OF BYTE		Process program data to save in equipment
	localPPDataLength	INT	0	Data size of process program data to save in equipment

External Variables	Variable	Comment
	_GEM_ServiceStatus	GEM Service status
	_GEM_BusyHostPPDownload	Host-initiated Process Program Download Transaction Processing Flag
	PPID_TABLE	Link variable for PPID management table
	HOST_DOWNLOAD_PPID	Link variable for host-initiated download - PPID
	HOST_DOWNLOAD_LENGTH	Link variable for host-initiated download - LENGTH
	HOST_DOWNLOAD_PPBODY	Link variable for host-initiated download - PPBODY

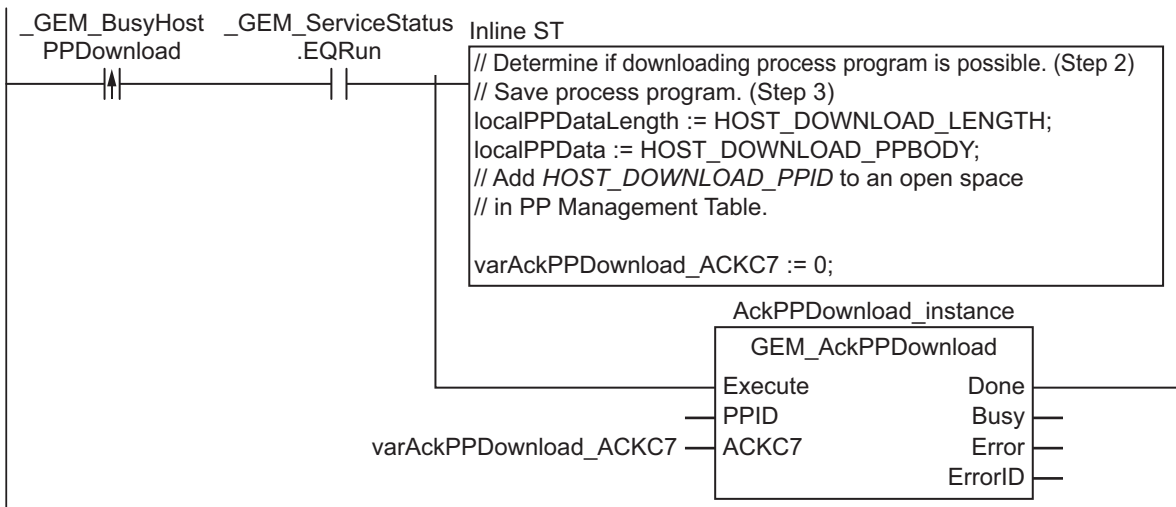



**ST**

Internal Variables	Variable	Data type	Initial value	Comment
	varAckPPDownloadACKC7	BYTE	0	Download accept/reject result
	AckPPDownload_instance	GEM_AckPP Download		Instance of GEM_AckPPDownload instruction
	R_TRIG_instance	R_TRIG		Instance of R_TRIG instruction
	Trigger	BOOL	FALSE	Flag for FALSE to TRUE change in <i>_GEM_BusyHostPPDownload</i>
	Stage	INT	0	Program execution status
	localPPData	ARRAY[0..9] OF BYTE		Process program data to save in equipment
	localPPDataLength	INT	0	Data size of process program data to save in equipment

External Variables	Variable	Comment
	_GEM_ServiceStatus	GEM Service status
	_GEM_BusyHostPPDownload	Host-initiated Process Program Download Transaction Processing Flag
	PPID_TABLE	Link variable for PPID management table
	HOST_DOWNLOAD_PPID	Link variable for host-initiated download - PPID
	HOST_DOWNLOAD_LENGTH	Link variable for host-initiated download - LENGTH
	HOST_DOWNLOAD_PPBODY	Link variable for host-initiated download - PPBODY

```

CASE Stage Of
0: // Notification of reception from host
  R_TRIG_instance( _GEM_BusyHostPPDownload, Trigger );
  IF( Trigger = TRUE )THEN
    // Perform processing to save process program as required.
    varAckPPDownloadACKC7:=BYTE#0; // Accepted.
    // Initialization
    AckPPDownload_instance( Execute:=FALSE, ACKC7:= varAckPPDownloadACKC7);
    Stage:=1;
  END_IF;
1: // Reply to host.
  AckPPDownload_instance( Execute:=TRUE, ACKC7:= varAckPPDownloadACKC7);
  IF( AckPPDownload_instance.Done = TRUE ) THEN
    Stage := 10;
  ELSIF( AckPPDownload_instance.Error = TRUE ) THEN
    // Add error processing as required.
    Stage := 10;
  END_IF;
10: // End
  Stage := 0;
END_CASE;

```

# GEM\_RequestFormattedPPDownload

The GEM\_RequestFormattedPPDownload instruction sends a request for a formatted process program download to the host.

Instruction	Name	FB/ FUN	Graphic expression	ST expression
GEM_RequestFormattedPPDownload	Request Formatted Process Program Download	FB		GEM_RequestFormattedPPDownload_instance( Execute, PPID, Done, Busy, Error, ErrorID);

## Variables

Name	Meaning	I/O	Description	Valid range	Unit	Default
PPID	Process program ID	Input	PPID for download request	121 bytes max. (including final NULL) *1	---	*2

\*1. The maximum number of characters is set on the SECS/GEM Configurator. The maximum number of bytes is the maximum number of characters including the final NULL character plus 1.

\*2. If you omit the input parameter, the default value is not applied. A building error will occur.

	Boolean	Bit strings				Integers						Real numbers		Times, durations, dates, and text strings						
	BOOL	BYTE	WORD	DWORD	LWORD	USINT	UINT	UDINT	ULINT	SINT	INT	DINT	LINT	REAL	LREAL	TIME	DATE	TOD	DT	STRING
PPID																				OK

## Function

The GEM\_RequestFormattedPPDownload instruction sends a request for a formatted process program download to the host. The following are required for the download request.

- Process program ID

This is the PPID of the formatted process program for the download request.

Refer to the application procedure for this instruction for the processing for the download request.

### Additional Information

- This instruction uses the Equipment-initiated Formatted Process Program Download scenario for the GEM Process Program Management capability.
- A SECS message is sent if this instruction is executed and execution ends normally. The SECS message exchange between the equipment and host is given below.

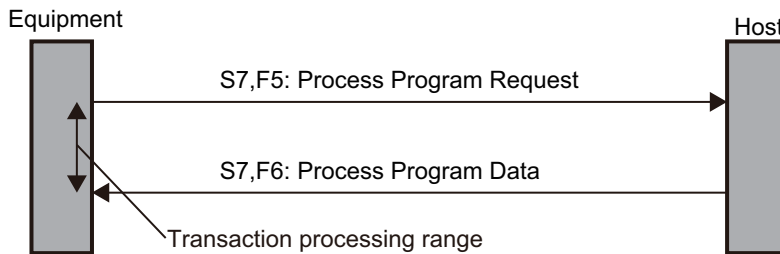

### Related System-defined Variables

Name	Meaning	Data type	Description
_GEM_BusyEquip FormattedPPDownload	Equipment-initiated Formatted Process Program Download Transaction Processing Flag	BOOL	Gives the status of processing a transaction for an equipment-initiated formatted process program download.*1 TRUE: Processing FALSE: Not processing
_GEM_EquipFormatted PPDownloadRslt	Equipment-initiated Formatted Process Program Download Result	_sGEM_RSLT	Gives the status of processing an equipment-initiated formatted process program download. Refer to P. A-222 for details.
_GEM_ServiceStatus	GEM Service Status	_sGEM_SERVICE_STATUS	Gives the GEM Service status. Refer to P. A-212 for details.

\*1. This variable changes to TRUE when the instruction ends normally. It changes to FALSE when transaction processing is completed.

### Related User-defined Variables

#### ● Equipment Management Variable

Name	Description	SECS/GEM Configurator setting
PPID Management Table	Used to manage PPID information inside the equipment. If the table contains NULL, no PPID information is registered.	Process Program

● Variables to Receive Download Request Results

Name	Description	SECS/GEM Configurator setting
Equipment-initiated Download Formatted PPID	Stores the PPID for the formatted process program downloaded from the host.	Process Program
Equipment-initiated Download MDLN	Stores the MDLN for the formatted process program downloaded from the host.	
Equipment-initiated Download SOFTREV	Stores the SOFTREV for the formatted process program downloaded from the host.	
Equipment-initiated Download Number of CCODEs	Stores the number of CCODEs for the formatted process program downloaded from the host.	
Equipment-initiated Download CCODE Table	Stores the CCODEs for the formatted process program downloaded from the host.	
Equipment-initiated Download PPARM Value	Stores the PPARM for the formatted process program downloaded from the host.	

**Related Error Codes**

Error code	Name	Description
16#3820	Too Many Characters	The value of <i>PPID</i> exceeded the size set on the SECS/GEM Configurator.
16#041D	Exceeded Simultaneous Instruction Executed Resources	The number of simultaneously executed GEM instructions exceeded the limit.
16#3822	Set to Disable	The instruction was executed when it was disabled on the SECS/GEM Configurator.
16#3810	GEM Service Status in Initializing	The instruction was executed when the GEM Service status was Initializing.
16#3811	GEM Service Status in EQStarting	The instruction was executed when the GEM Service status was EQStarting.
16#3812	GEM Service Status in EQInitializing	The instruction was executed when the GEM Service status was EQInitializing.
16#3814	GEM Service Status in Stop	The instruction was executed when the GEM Service status was Stop.
16#3815	GEM Service Status in Error	The instruction was executed when the GEM Service status was Error.
16#3816	GEM Service Status in ShuttingDown	The instruction was executed when the GEM Service status was ShuttingDown.
16#3817	GEM Service Status in Shutdown	The instruction was executed when the GEM Service status was Shutdown.
16#3819	Multi-execution of Instructions	Transaction processing is not completed for a previous execution of the same instruction.
16#381B	Insufficient Transaction Resource	When the instruction was executed, the limit to the number of transactions that can be buffered had been reached.

**Precautions for Correct Use**

- Before executing the instruction, confirm that all of the following conditions are met. If the instruction is executed when any of these conditions is not met, an error will occur and *Error* will change to TRUE.
  - a) *\_GEM\_ServiceStatus* must be *EQRun*.
  - b) *\_GEM\_BusyEquipFormattedPPDownload* must be TRUE.
- *Access \_GEM\_EquipFormattedPPDownloadRslt*, after *\_GEM\_BusyEquipFormattedPPDownload* changes from TRUE to FALSE.

## Application Procedure

Use the following procedure for this instruction.

- 1** Requesting the Formatted Process Program Download
 

Specify the PPID for which to request a download in the *PPID* input variable and execute the instruction. A request for a formatted process program download is sent to the host.
- 2** Detecting the Reply to the Download Request
 

Confirm that *\_GEM\_BusyEquipFormattedPPDownload* changes from TRUE to FALSE. The download result is stored in *\_GEM\_EquipFormattedPPDownloadRslt* as the download request reply.
- 3** Confirming the Download Result
 

If the download was successful, the formatted process program is stored in the following variables.

  - Equipment-initiated Download Formatted PPID
  - Equipment-initiated Download MDLN
  - Equipment-initiated Download SOFTREV
  - Equipment-initiated Download Number of CCODEs
  - Equipment-initiated Download CCODE Table
  - Equipment-initiated Download PPARM Value
- 4** Determining the Validity of the Formatted Process Program
 

If the download was successful, determine the validity of the formatted process program that was downloaded. Examples of the criteria to determine validity are given below.

  - Are the values in *Host-initiated Download MDLN* and *\_GEM\_EquipInfo.MDLN* the same?
  - Are the values in *Host-initiated Download SOFTREV* and *\_GEM\_EquipInfo.SOFTREV* the same?
  - Is the value of *Host-initiated Download PPARM* inside of the valid range?

If the validity determination result is to be sent to the host, you must execute the *GEM\_SendPPVerify* instruction in step 6 to store the required items in user-defined variables. Refer to the related user-defined variables for the *GEM\_SendPPVerify* on page A-151 for details on the user-defined variables.
- 5** Saving the Formatted Process Program
 

If the formatted process program is valid, store the formatted process program that was downloaded in the equipment. If required, confirm that the process program was saved.

If the formatted process program was saved and if the PPID in *Host-initiated Download Formatted PPID* is not in *PPID Management Table*, add it to *PPID Management Table*. If it is already in *PPID Management Table*, it does not need to be added.
- 6** Sending the Result of Confirming the Validity of the Formatted Process Program
 

Store the number of invalid PPARM values from the validity confirmation result in step 4 in the *ErrorNum* input variable and execute the *GEM\_SendPPVerify* instruction.

The formatted process program verification result is sent to the host.

The following diagram shows the user program processing and data flow for the application procedure. The diagram shows an example of a request to the host to download the formatted process program with a PPID of RUN. Numbers 1 to 6 in the diagram indicate the steps in the application procedure.

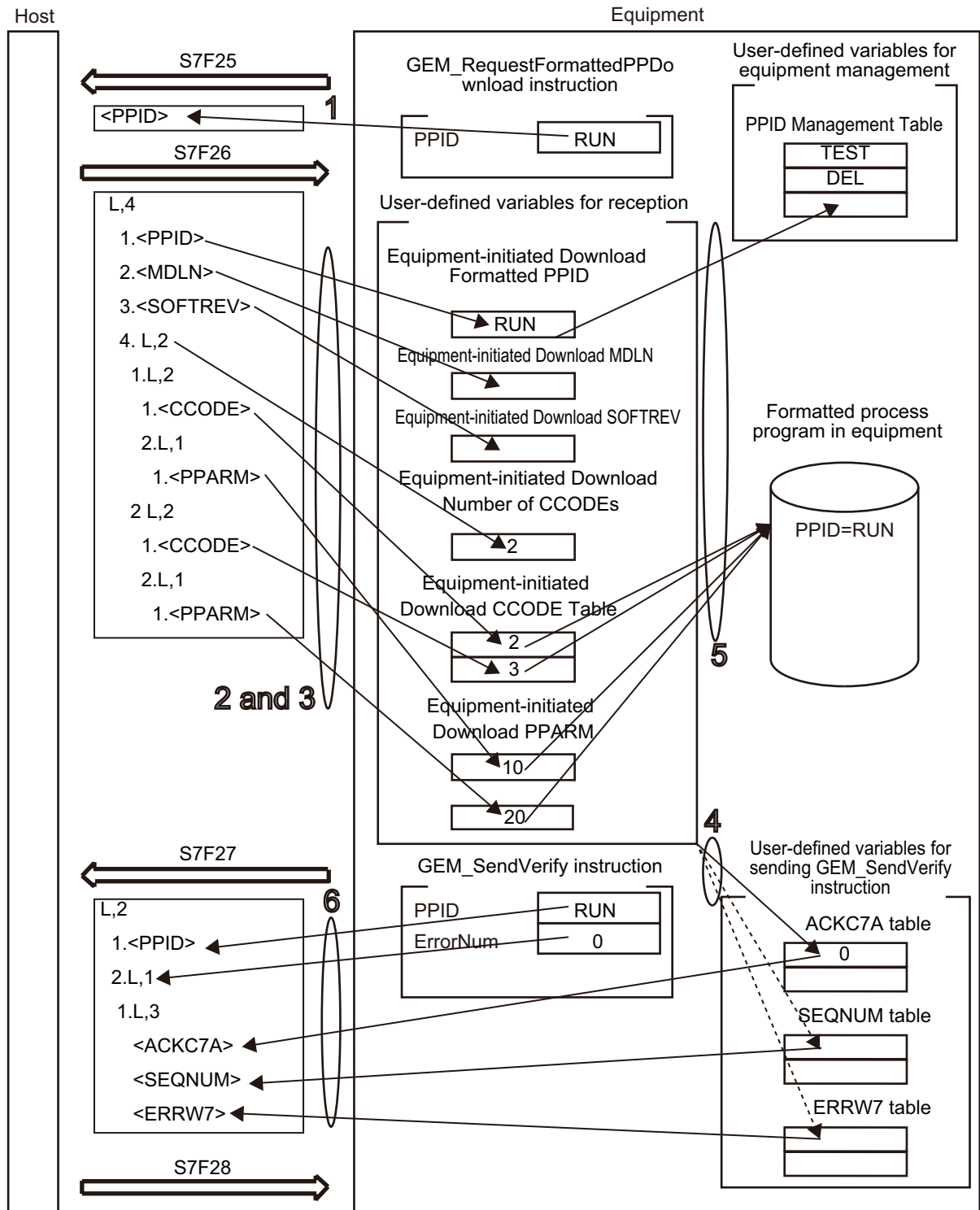

## Sample Programming

This sample requests downloading a formatted process program with a PPID of Sample1 to the host. This sample sends the verification result for the downloaded formatted process program to the host.

If the GEM Service status is EQRun and the *RequestFormattedPPDownload\_Start* internal variable changes from FALSE to TRUE, a download request is made.

The downloaded formatted process program that is downloaded from the host is Sample1.

Destination information is stored in the Sample1 formatted process program.

The structure of PPARM is as follows and is registered for CCODE = 1.

L,3 1.<I2 X> 2.<I2 Y> 3.<I2 Z>	The structure of PPARM is defined as shown on the left. X: X coordinate Y: Y coordinate Z: Z coordinate
---	--

For CCODE = 2, register the following.

L,2 1.<U2 LimitMin> 2.<U2 LimitMax>	The structure of PPARM is defined as shown on the left. LimitMin: Lower limit LimitMax: Upper limit
---	---

## SECS/GEM Configurator

First, the relevant variables are registered on the SECS/GEM Configurator.

Only the items that are related to the GEM\_RequestFormattedPPDownload instruction are given in the following table.

### ● Process Program – Operation Settings

Item	Set value
Number of saved process programs	5
Link variable for PPID management table	PPID_TABLE

### ● Process Program – Formatted (1)

The formatted process program for the equipment-initiated download is as follows:

CCODE	Description	Maximum number of PPARAMs	Format	Data size	Link variables	
1	Coordinates	3	I2	1	EQUIP__DOWN-LOAD_FPP_P-PARM1_TABLE	EQUIP_DOWN-LOAD_FPP_P-PARM1_NUMBER
2	Temperature	2	U2	1	EQUIP__DOWN-LOAD_FPP_PPARAM1_TABLE	EQUIP_DOWNLOAD_FPP_PPARAM1_NUMBER

● **Process Program – Formatted (2)**

Item	Set value
Link variable for equipment-initiated download - PPID	EQUIP_DOWNLOAD_FPP_PPID
Link variable for equipment-initiated download - MDLN	EQUIP_DOWNLOAD_FPP_MDLN
Link variable for equipment-initiated download - SOFTREV	EQUIP_DOWNLOAD_FPP_SOFTREV
Link variable for equipment-initiated download - CCODE count	EQUIP_DOWNLOAD_FPP_CCODE_NUMBER
Link variable for equipment-initiated download - CCODE table	EQUIP_DOWNLOAD_FPP_CCODE_TABLE
Link variable for verification result - ACKC7A table	FPP_VERIFY_ACKC7A_TBABLE
Link variable for verification result - SEQNUM table	FPP_VERIFY_SEQNUM_TABLE
Link variable for verification result - ERRW7 table	FPP_VERIFY_ERRW7_TABLE

Next, enter the programming on the Sysmac Studio.

**LD**

Internal Variables	Variable	Data type	Initial value	Comment
	RequestFormattedPP Download_Start	BOOL	FALSE	Flag to start download request
	RequestFormattedPP Download_instance	GEM_Request- FormattedP- PDownload		Instance of GEM_RequestFormat- tedPPDownload instruction
	SendPPVerify_instance	GEM_SendP- PVerify		Instance of GEM_SendPPVerify instruction
	RequestFormattedPP Download_WaitResp	BOOL	FALSE	Flag that indicates waiting for com- pletion of download request
	RequestFormattedPP Download_Complete	BOOL	FALSE	Flag that indicates completion of download request
	varDownloadFormatted PPID	STRING[41]	NULL	PPID for download request
	varVerifyErrorNum	UINT	0	Number of errors in verification results
	localPPARM	ARRAY[0..2] OF INT		PPARM value of formatted process program to save in equipment
	localPPARMNumber	INT	0	Number of PPARMs for formatted process program to save in equip- ment

External Variables	Variable	Comment
	_GEM_ServiceStatus	GEM Service status
	_GEM_BusyEquipFormattedPPDownload	Equipment-initiated Formatted Process Program Download Transaction Processing Flag
	_GEM_EquipFormattedPPDownloadRsit	Equipment-initiated Formatted Process Program Download Results
	EQUIP_DOWNLOAD_FPP_PPARAM1_TABLE	Link variable for PPARAM table for CCODE = 1
	EQUIP_DOWNLOAD_FPP_PPARAM1_NUMBER	Link variable for PPARAM count for CCODE = 1



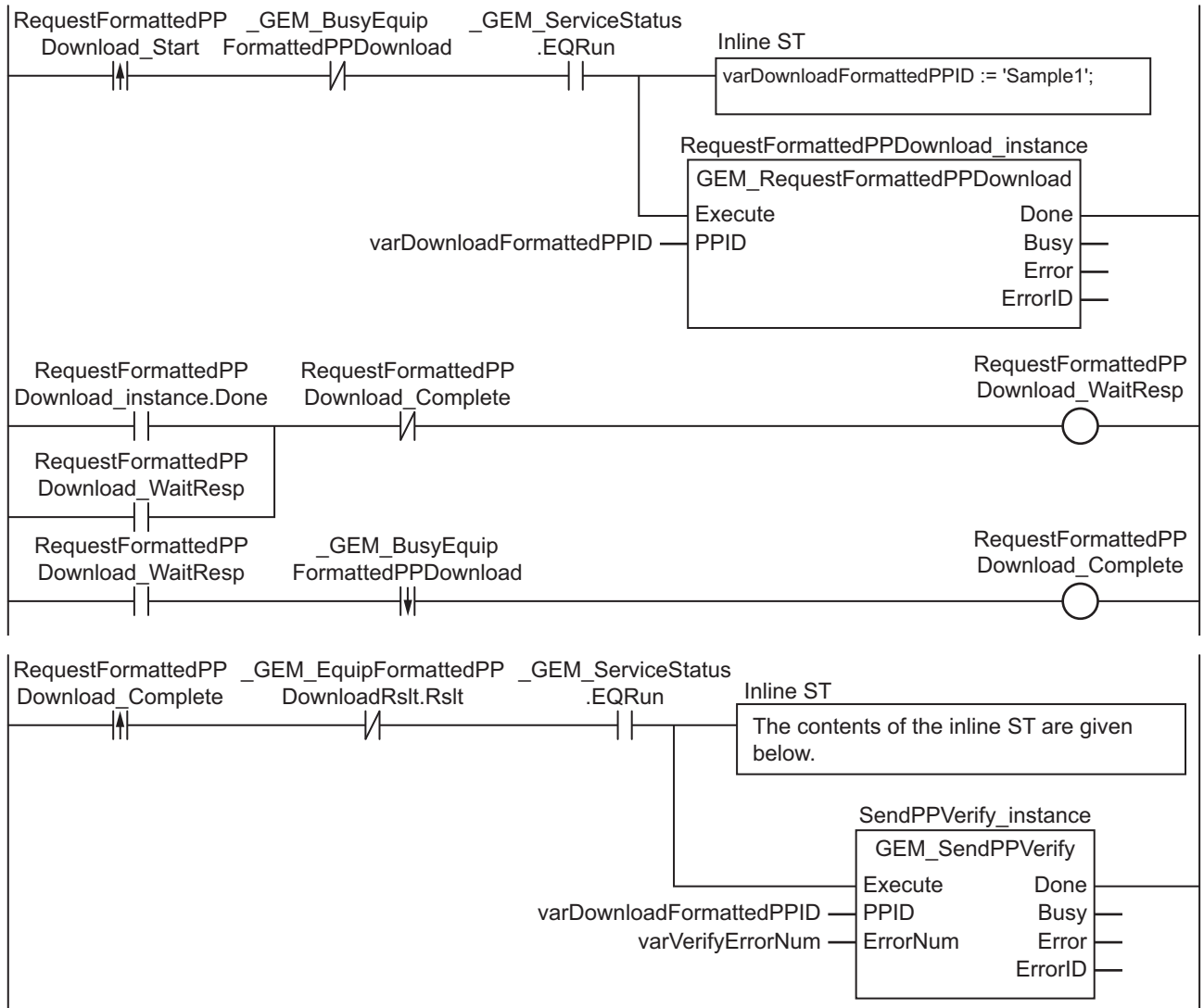

● **Contents of Inline ST**

```
// Verify formatted process program. (Step 4)
varVerifyErrorNum := 0;
// Save formatted process program. (Step 5)
localPPARM[0] := EQUIP_DOWNLOAD_FPP_PPARM1_TABLE[0];
localPPARM[1] := EQUIP_DOWNLOAD_FPP_PPARM1_TABLE[1];
localPPARM[2] := EQUIP_DOWNLOAD_FPP_PPARM1_TABLE[2];
localPPARMNumber := EQUIP_DOWNLOAD_FPP_PPARM1_NUMBER;
```

- Note 1. In step 4, above, add the programming to verify the formatted process program as required.  
 2. In step 5, above, add the programming to add the PPID to the PPID Management Table.

**ST**

Internal Variables	Variable	Data type	Initial value	Comment
	RequestFormattedPPDownload_Start	BOOL	FALSE	Flag to start download request
	RequestFormattedPPDownload_instance	GEM_RequestFormattedPPDownload		Instance of GEM_RequestFormattedPPDownload instruction
	SendPPVerify_instance	GEM_SendPPVerify		Instance of GEM_SendPPVerify instruction
	varDownloadFormattedPPID	STRING[41]	NULL	PPID for download request
	varVerifyErrorNum	UINT	0	Number of errors in verification results
	R_TRIG_instance	R_TRIG		Instance of R_TRIG instruction
	F_TRIG_instance	F_TRIG		Instance of F_TRIG instruction
	Trigger	BOOL	FALSE	Flag for FALSE to TRUE change in <i>RequestFormattedPPDownload_Start</i> Flag for TRUE to FALSE change in <i>_GEM_BusyEquipFormattedPPDownload</i>
	localPPARM	ARRAY[0..2] OF INT		PPARM value of formatted process program to save in equipment
	localPPARMNumber	INT	0	Number of PPARMs for formatted process program to save in equipment

External Variables	Variable	Comment
	_GEM_ServiceStatus	GEM Service status
	_GEM_BusyEquipFormattedPPDownload	Equipment-initiated Formatted Process Program Download Transaction Processing Flag
	_GEM_EquipFormattedPPDownloadRslt	Equipment-initiated Formatted Process Program Download Results
	EQUIP_DOWNLOAD_FPP_PPARM1_TABLE	Link variable for PPARM table for CCODE = 1
	EQUIP_DOWNLOAD_FPP_PPARM1_NUMBER	Link variable for PPARM count for CCODE = 1

```

CASE Stage Of
0: // Start
  R_TRIG_instance( RequestFormattedPPDownload_Start, Trigger );
  IF( (Trigger = TRUE)
    AND ( _GEM_ServiceStatus.EQRun = TRUE ) ) THEN
    varDownloadFormattedPPID := 'Sample1';
    RequestFormattedPPDownload_instance( Execute:=FALSE, PPID:=varDownloadFormattedPPID );
    SendPPVerify_instance( PPID:= varDownloadFormattedPPID, ErrorNum:=varVerifyErrorNum );
    Stage := 1;
  END_IF;

```

```

1: // Request formatted process program download. (Step 1)
  RequestFormattedPPDownload_instance( Execute:=TRUE, PPID:=varDownloadFormattedPPID
);
  IF( RequestFormattedPPDownload_instance.Done = TRUE ) THEN
    Stage := 2;
  ELSIF( RequestFormattedPPDownload_instance.Error = TRUE ) THEN
    Stage := 10;
  END_IF;
2: // Detect reply to download request. (Step 2)
  F_TRIG_instance( _GEM_BusyEquipFormattedPPDownload, Trigger);
  IF( Trigger =TRUE ) THEN
    // Confirm download results. (Step 3)
    IF( _GEM_EquipFormattedPPDownloadRsult.Rsult = TRUE ) THEN
      Stage := 3;
    ELSE
      Stage := 10;
    END_IF;
  END_IF;
3: // Verify the formatted process program. (Step 4)
  varVerifyErrorNum := 0;
  //Save formatted process program. (Step 5)
  localPPARM[0] := EQUIP_DOWNLOAD_FPP_PPARM1_TABLE[0];
  localPPARM[1] := EQUIP_DOWNLOAD_FPP_PPARM1_TABLE[1];
  localPPARM[2] := EQUIP_DOWNLOAD_FPP_PPARM1_TABLE[2];
  localPPARMNumber := EQUIP_DOWNLOAD_FPP_PPARM1_NUMBER;
  Stage := 4;
4: // Send result of verifying formatted process program. (Step 6)
  SendPPVerify_instance( PPID:= varDownloadFormattedPPID, ErrorNum:=varVerifyError-
Num );
  IF( SendPPVerify_instance.Done = TRUE ) THEN
    Stage := 10;
  ELSIF( SendPPVerify_instance.Error = TRUE ) THEN
    Stage := 10;
  END_IF;
10: // End
  Stage := 0;
END_CASE;

```

# GEM\_RequestPPDownload

The GEM\_RequestPPDownload instruction sends a process program download request to the host.

Instruction	Name	FB/ FUN	Graphic expression	ST expression
GEM_RequestPPDownload	Request Process Program Download	FB		GEM_RequestPPDownload_instance(  Execute, PPID, Done, Busy, Error, ErrorID);

## Variables

Name	Meaning	I/O	Description	Valid range	Unit	Default
PPID	Process program ID	Input	PPID for download request	121 bytes max. (including final NULL)*1	---	*2

\*1. The maximum number of characters is set on the SECS/GEM Configurator. The maximum number of bytes is the maximum number of characters including the final NULL character plus 1.

\*2. If you omit the input parameter, the default value is not applied. A building error will occur.

	Boolean	Bit strings				Integers							Real numbers		Times, durations, dates, and text strings					
	BOOL	BYTE	WORD	DWORD	LWORD	USINT	UINT	UDINT	ULINT	SINT	INT	DINT	LINT	REAL	LREAL	TIME	DATE	TOD	DT	STRING
PPID																				OK

## Function

The GEM\_RequestPPDownload instruction sends a process program download request to the host. The following are required for the download request.

- Process program ID

This is the PPID of the process program for the download request.

Refer to the application procedure for this instruction for the processing for the download request.

### Additional Information

- This instruction uses the Equipment-initiated Process Program Download scenario for the GEM Process Program Management capability.
- A SECS message is sent if this instruction is executed and execution ends normally. The SECS message exchange between the equipment and host is given below.

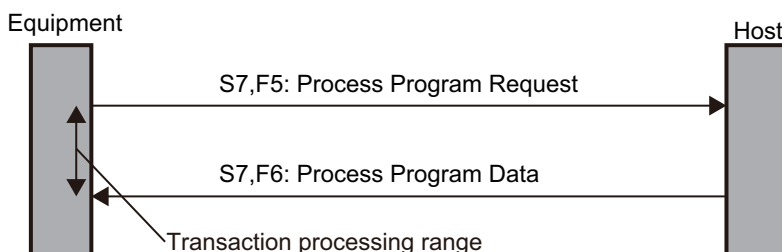

### Related System-defined Variables

Name	Meaning	Data type	Description
_GEM_Busy-EquipPPDownload	Equipment-initiated Process Program Download Transaction Processing Flag	BOOL	Gives the status of processing a transaction for an equipment-initiated process program download. *1 TRUE: Processing FALSE: Not processing
_GEM_EquipPPDownloadRslt	Equipment-initiated Process Program Download Result	_sGEM_RESULT	Gives the result of processing an equipment-initiated process program download. Refer to P. A-223 for details.
_GEM_ServiceStatus	GEM Service Status	_sGEM_SERVICE_STATUS	Gives the GEM Service status. Refer to P. A-212 for details.

\*1. This variable changes to TRUE when the instruction ends normally. It changes to FALSE when transaction processing for the equipment-initiated process program download is completed.

### Related User-defined Variables

#### ● Equipment Management Variable

Name	Description	SECS/GEM Configurator setting
PPID Management Table	Used to manage PPID information inside the equipment. If the table contains NULL, no PPID information is registered.	Process Program

#### ● Variable to Receive Download Request

Name	Description	SECS/GEM Configurator setting
Equipment-initiated Download PPID	Stores the process program PPID for the equipment-initiated download.	Process Program – Unformatted
Equipment-initiated Download LENGTH	Stores the LENGTH of the process program for the equipment-initiated download.	
Equipment-initiated Download PPBODY	Stores the PPBODY of the process program for the equipment-initiated download.	

## Related Error Codes

Error code	Name	Description
16#3820	Too Many Characters	The value of <i>PPID</i> exceeded the size set on the SECS/GEM Configurator.
16#041D	Exceeded Simultaneous Instruction Executed Resources	The number of simultaneously executed GEM instructions exceeded the limit.
16#3822	Set to Disable	The instruction was executed when it was disabled on the SECS/GEM Configurator.
16#3810	GEM Service Status in Initializing	The instruction was executed when the GEM Service status was Initializing.
16#3811	GEM Service Status in EQStarting	The instruction was executed when the GEM Service status was EQStarting.
16#3812	GEM Service Status in EQInitializing	The instruction was executed when the GEM Service status was EQInitializing.
16#3814	GEM Service Status in Stop	The instruction was executed when the GEM Service status was Stop.
16#3815	GEM Service Status in Error	The instruction was executed when the GEM Service status was Error.
16#3816	GEM Service Status in ShuttingDown	The instruction was executed when the GEM Service status was ShuttingDown.
16#3817	GEM Service Status in Shutdown	The instruction was executed when the GEM Service status was Shutdown.
16#3819	Multi-execution of Instructions	Transaction processing is not completed for a previous execution of the same instruction.
16#381B	Insufficient Transaction Resource	When the instruction was executed, the limit to the number of transactions that can be buffered had been reached.

## Precautions for Correct Use

- Before executing the instruction, confirm that all of the following conditions are met. If the instruction is executed when any of these conditions is not met, an error will occur and *Error* will change to TRUE.
  - a) *\_GEM\_ServiceStatus* must be *EQRun*.
  - b) *\_GEM\_BusyEquipPPDownload* must be FALSE.
- Access *\_GEM\_EquipPPDownloadRsIt* after *\_GEM\_BusyEquipPPDownload* changes from TRUE to FALSE.

## Application Procedure

Use the following procedure for this instruction.

- 1** Requesting the Process Program Download
 

Specify the process program ID for which to request a download in the *PPID* input variable and execute the instruction. A request is made to the host to download a process program.
- 2** Detecting the Reply to the Download Request
 

Confirm that *\_GEM\_BusyEquipPPDownload* changes from TRUE to FALSE.  
The process program download result is stored in *\_GEM\_EquipPPDownloadRsIt* as the download request reply.
- 3** Confirming the Download Request Result

If the process program download was successful, the process program is stored in the following variables. If the download failed, nothing is stored in the following variables.

- Equipment-initiated Download PPID
- Equipment-initiated Download LENGTH
- Equipment-initiated Download PPBODY

#### 4 Updating Process Program

If the process program download was successful, the downloaded process program is saved. If required, confirm that the process program was saved. If it was saved and the PPID in *Host-initiated Download Formatted PPID* is not in *PPID Management Table*, add it to *PPID Management Table*. If it is already in *PPID Management Table*, it does not need to be added.

The following diagram shows the user program processing and data flow for the application procedure. The diagram shows an example of a request to the host to download the process program with a PPID of *RUN*. Numbers 1 to 4 in the diagram indicate the steps in the application procedure.

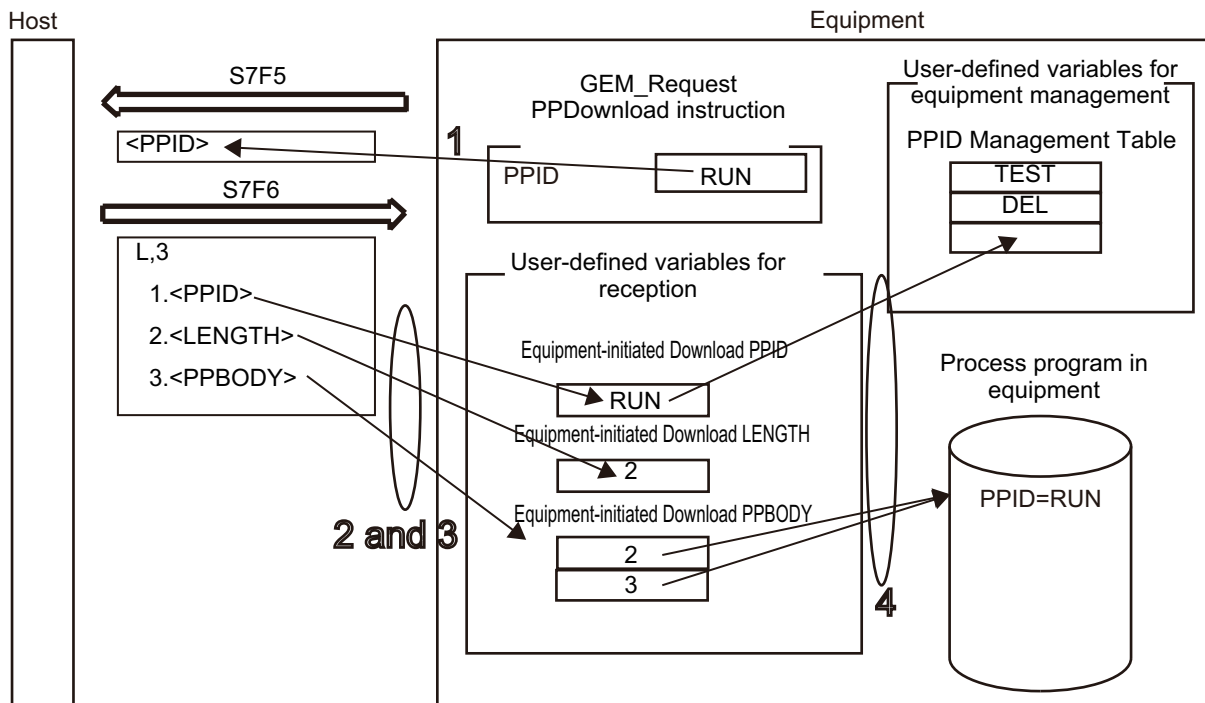



## Sample Programming

This sample requests downloading a process program to the host.

If the GEM Service status is EQRun and the *RequestPPDownload\_Start* internal variable changes from FALSE to TRUE, a download request is made.

## SECS/GEM Configurator

First, the relevant variables are registered on the SECS/GEM Configurator.

Only the items that are related to the GEM\_RequestPPDownload instruction are given in the following table.

### ● Process Program – Operation Settings

Item	Set value
Number of saved process programs	5
Link variable for PPID management table	PPID_TABLE

### ● Process Program – Unformatted

Item	Set value
PPBODY format	B
PPBODY data size	10
Link variable for equipment-initiated download - PPID	EQUIP_DOWNLOAD_PPID
Link variable for equipment-initiated download - LENGTH	EQUIP_DOWNLOAD_LENGTH
Link variable for equipment-initiated download - PPBODY	EQUIP_DOWNLOAD_PPBODY

Next, enter the programming on the Sysmac Studio.

## LD

Internal Variables	Variable	Data type	Initial value	Comment
	RequestPPDownload_Start	BOOL	FALSE	Flag to start download request
	RequestPPDownload_instance	GEM_RequestPPDownload		Instance of GEM_RequestPPDownload instruction
	RequestPPDownload_WaitResp	BOOL	FALSE	Flag that indicates waiting for completion of download request
	RequestPPDownload_Complete	BOOL	FALSE	Flag that indicates completion of download request
	varDownloadPPID	STRING[41]	NULL	PPID for download request
	localPPData	ARRAY[0..9] OF BYTE		Process program data to save in equipment
	localPPDataLength	INT	0	Data size of process program data to save in equipment

External Variables	Name	Comment
	<u>_GEM_ServiceStatus</u>	GEM Service status
	<u>_GEM_BusyEquipPPDownload</u>	Equipment-initiated Process Program Download Transaction Processing Flag
	<u>_GEM_EquipPPDownloadRslt</u>	Equipment-initiated Formatted Process Program Download Results
	PPID_TABLE	Link variable for PPID management table
	EQUIP_DOWNLOAD_PPID	Link variable for equipment-initiated download - PPID
	EQUIP_DOWNLOAD_LENGTH	Link variable for equipment-initiated download - LENGTH
	EQUIP_DOWNLOAD_PPBODY	Link variable for equipment-initiated download - PPBODY

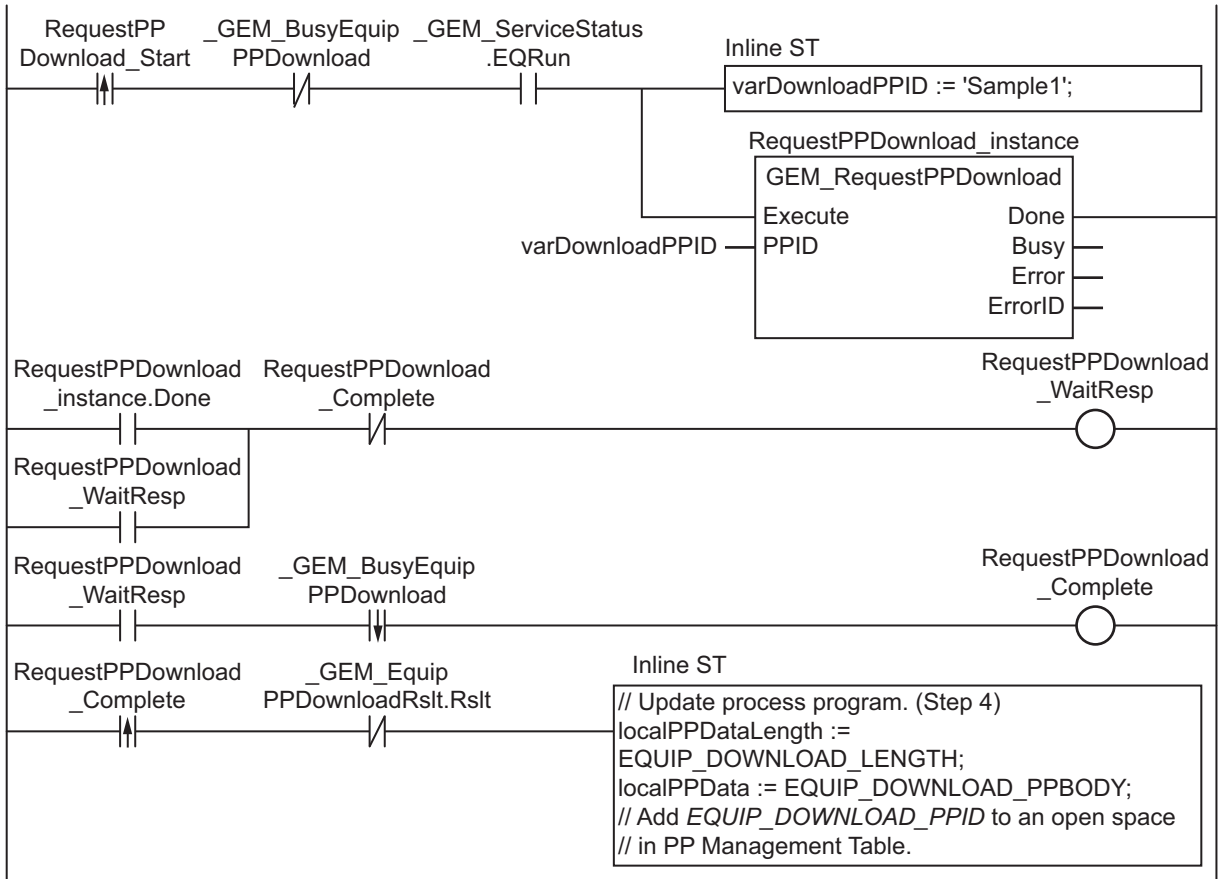

**ST**

Internal Variables	Variable	Data type	Initial value	Comment
	RequestPPDownload_Start	BOOL		Flag to start download request
	RequestPPDownload_instance	GEM_RequestPPDownload		Instance of GEM_RequestPPDownload instruction
	varDownloadPPID	STRING[41]		PPID for download request
	R_TRIG_instance	R_TRIG		Instance of R_TRIG instruction
	F_TRIG_instance	F_TRIG		Instance of F_TRIG instruction
	Trigger	BOOL	FALSE	Flag for FALSE to TRUE change in <i>RequestPPDownload_Start</i> Flag for TRUE to FALSE change in <i>_GEM_BusyEquipPPDownload</i>
	Stage	INT	0	Program execution status
	localPPData	ARRAY[0..9] OF BYTE		Process program data to save in equipment
	localPPDataLength	INT	0	Data size of process program data to save in equipment

External Variables	Variable	Comment
	_GEM_ServiceStatus	GEM Service status
	_GEM_BusyEquipPPDownload	Equipment-initiated Process Program Download Transaction Processing Flag
	_GEM_EquipPPDownloadRslt	Equipment-initiated Process Program Download Results
	PPID_TABLE	Link variable for PPID management table
	EQUIP_DOWNLOAD_PPID	Link variable for equipment-initiated download - PPID
	EQUIP_DOWNLOAD_LENGTH	Link variable for equipment-initiated download - LENGTH
	EQUIP_DOWNLOAD_PPBODY	Link variable for equipment-initiated download - PPBODY

```

CASE Stage Of
0: // Start
  R_TRIG_instance( RequestPPDownload_Start, Trigger );
  IF( Trigger = TRUE)
    AND ( _GEM_ServiceStatus.EQRun = TRUE ) ) THEN
    varDownloadPPID := 'Sample1';
    RequestPPDownload_instance( Execute:=FALSE, PPID:=varDownloadPPID );
    Stage := 1;
  END_IF;
1: // Request download to host.
  RequestPPDownload_instance( Execute:=TRUE, PPID:=varDownloadPPID );
  IF( RequestPPDownload_instance.Done = TRUE ) THEN
    Stage := 2;
  ELSIF( RequestPPDownload_instance.Error = TRUE ) THEN
    Stage := 10;
  END_IF;
2: // Detect reception of download.
  F_TRIG_instance( _GEM_BusyEquipPPDownload, Trigger);
  IF( Trigger =TRUE ) THEN
    IF( _GEM_EquipPPDownloadRslt.Rslt = TRUE ) THEN
      // Update process program. (Step 4)
      localPPDataLength := EQUIP_DOWNLOAD_LENGTH;
      localPPData := EQUIP_DOWNLOAD_PPBODY;
      // Add EQUIP_DOWNLOAD_PPID to an open space in PP Management Table.
      Stage := 10;
    ELSE

```

```
        Stage := 10;  
    END_IF;  
END_IF;  
10: // End  
    Stage := 0;  
END_CASE;
```

# GEM\_SendPPVerify

The GEM\_SendPPVerify instruction sends the formatted process program verification result to the host.

Instruction	Name	FB/ FUN	Graphic expression	ST expression
GEM_SendPPVerify	Send Process Program Verification Result	FB		GEM_SendPPVerify_instance( Execute, PPID, ErrorNum, Done, Busy, Error, ErrorID);

## Variables

Name	Meaning	I/O	Description	Valid range	Unit	Default
PPID	Process program ID	Input	Verified PPID	121 bytes max. (including final NULL)*1	---	*2
ErrorNum	Number of errors		Number of errors in verification results	Depends on data type.		0

\*1. The maximum number of characters is set on the SECS/GEM Configurator. The maximum number of bytes is the maximum number of characters including the final NULL character plus 1.

\*2. If you omit the input parameter, the default value is not applied. A building error will occur.

	Boolean	Bit strings				Integers							Real numbers		Times, durations, dates, and text strings					
	BOOL	BYTE	WORD	DWORD	LWORD	USINT	UINT	UDINT	ULINT	SINT	INT	DINT	LINT	REAL	LREAL	TIME	DATE	TOD	DT	STRING
PPID																				OK
ErrorNum						OK	OK			OK	OK									

## Function

The GEM\_SendPPVerify instruction sends to the host, the verification result for the formatted process program downloaded from the host.

The PPID of the verified formatted process program is specified with *PPID*. The number of parameter errors in the formatted process program is specified in *ErrorNum*.

## Additional Information

- A SECS message is sent if this instruction is executed and execution ends normally. The SECS message exchange between the equipment and host is given below.

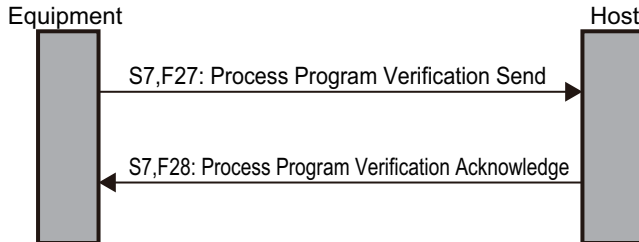

## Related System-defined Variables

Name	Meaning	Data type	Description
_GEM_ServiceStatus	GEM Service Status	_sGEM_SERVICE_STATUS	Gives the GEM Service status. Refer to P. A-212 for details.

## Related User-defined Variables

Name	Description	SECS/GEM Configurator setting
ACKC7A Table	Stores the acknowledge codes (ACKC7A) for the parameters that were verified. 16#00 = Acknowledged. 16#01 = MDLN does not match. 16#02 = SOFTREV does not match. 16#03 = Invalid CCODE. 16#04 = Invalid PPARM value 16#05 = Other error (indicated by ERRW7) 16#06 to 16#3F = Reserved.	Process Program
SEQNUM Table	Store the numbers that give the positions in CCODE.*1	
ERRW7 Table	Stores a text string that indicates the error.	

\*1. If *ACKC7A Table* contains 16#01 or 16#02, 0 is stored. If it contains 16#03, 16#04, or 16#05, 1 or higher is stored.

An example in which there is an error in a value in the PPARM for the formatted process program that was downloaded from the host is provided in the following diagram.

If there are more than 14 PPARM values, the text string OVER is sent as the verification result to indicate an error.

In the following diagram, an error occurs because the PPARM value for CCODE = 3 in CCODE Table [1] is 20. Therefore, the following data is stored in the user-defined variables.

- **ACKC7A Table**  
When returning a text string that indicates an error, the acknowledge code is for “other errors” and 16#05 is stored in *ACKC7A Table [0]*.
- **SEQNUM Table**  
The value that is one higher than the array element number in *CCODE Table* with the error is stored in *SEQNUM Table*. The error is in *CCODE Table [1]*, so 2 is stored in *SEQNUM Table [0]*.
- **ERRW7 Table**  
The text string OVER is stored in *ERRW7 Table [0]*.

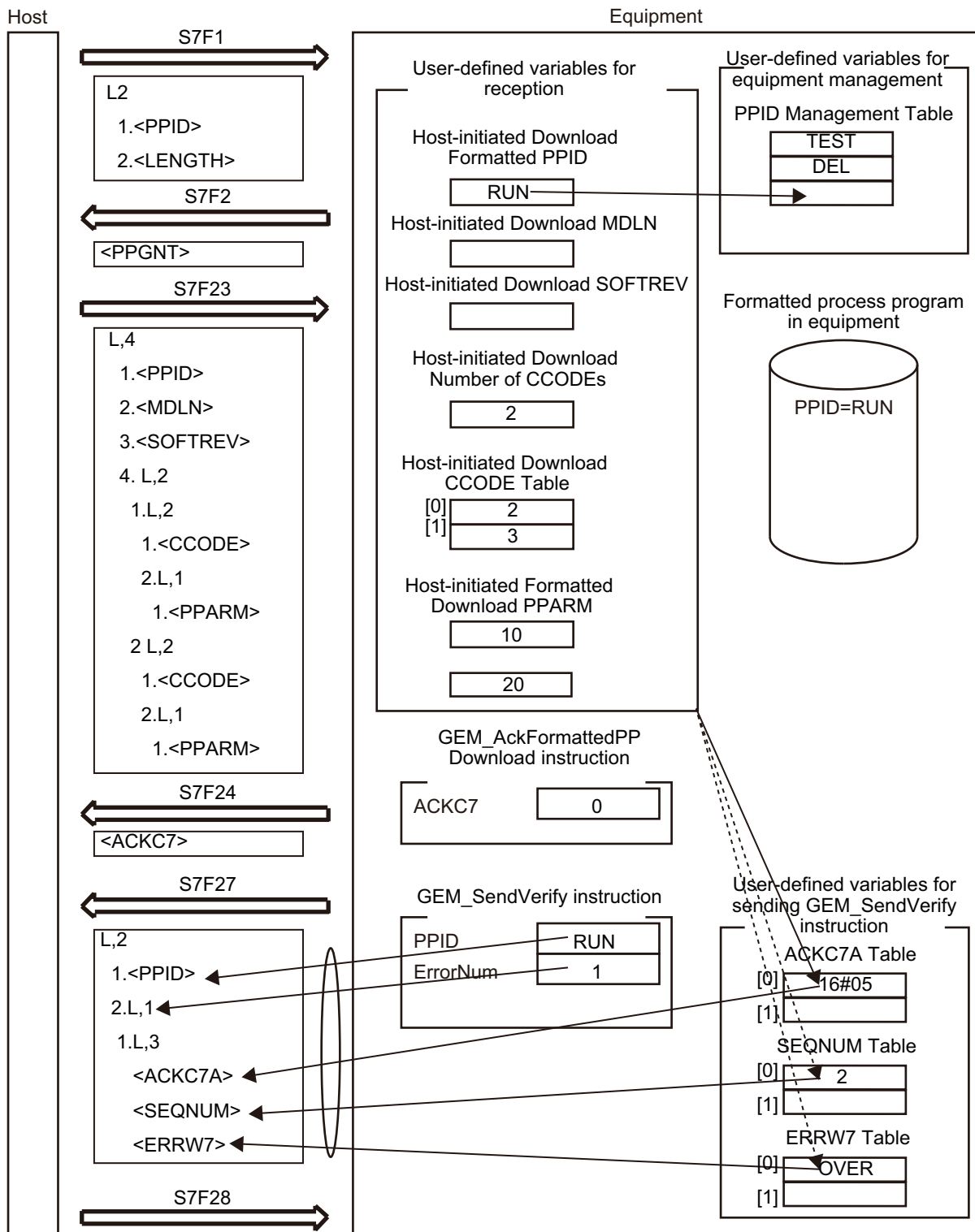

### Related Error Codes

Error code	Name	Description
16#3820	Too Many Characters	The data size of <i>PPID</i> exceeded the size set on the SECS/GEM Configurator.
16#041D	Exceeded Simultaneous Instruction Executed Resources	The number of simultaneously executed GEM instructions exceeded the limit.

Error code	Name	Description
16#3822	Set to Disable	The instruction was executed when it was disabled on the SECS/GEM Configurator.
16#3821	Invalid Size	The value specified in <i>ErrorNum</i> is larger than the number of array elements in the <i>ACKC7A Table</i> , <i>SEQNUM Table</i> , or <i>ERRW7 Table</i> user-defined variable.
16#3834	ACKC7A Out of Range	The value of <i>ACKC7A</i> is outside of the valid range.
16#3810	GEM Service Status in Initializing	The instruction was executed when the GEM Service status was Initializing.
16#3811	GEM Service Status in EQStarting	The instruction was executed when the GEM Service status was EQStarting.
16#3812	GEM Service Status in EQInitializing	The instruction was executed when the GEM Service status was EQInitializing.
16#3814	GEM Service Status in Stop	The instruction was executed when the GEM Service status was Stop.
16#3815	GEM Service Status in Error	The instruction was executed when the GEM Service status was Error.
16#3816	GEM Service Status in ShuttingDown	The instruction was executed when the GEM Service status was ShuttingDown.
16#3817	GEM Service Status in Shutdown	The instruction was executed when the GEM Service status was Shutdown.
16#3818	No Message Received	The instruction was executed when a formatted process program download data was not received.
16#381B	Insufficient Transaction Resource	When the instruction was executed, the limit to the number of transactions that can be buffered had been reached.

### Precautions for Correct Use

- Before executing the instruction, confirm that all of the following conditions are met. If the instruction is executed when any of these conditions is not met, an error will occur and *Error* will change to TRUE.
  - a) *\_GEM\_ServiceStatus* must be *EQRun*.
  - b) The values of *ACKC7A* specified in *ACKC7 Table* must be within the valid range.
  - c) The value specified for *ErrorNum* must be equal to or less than the number of array elements in *ACKC7A Table*, *SEQNUM Table*, and *ERRW7 Table*.
- An error does not occur when you execute the instruction even if you specify a different PPID in the PPID input variable compared with the PPID of the downloaded formatted process program.

### Sample Programming

Refer to the sample programming that is provided for the *GEM\_UploadFormattedPP* on page A-98.



# GEM\_SendTerminalMsg

The GEM\_SendTerminalMsg instruction sends an equipment terminal message to the host.

Instruction	Name	FB/ FUN	Graphic expression	ST expression
GEM_SendTerminalMsg	Send Equipment Terminal Message	FB		<pre>GEM_SendTerminalMsg_ instance(     Execute,     TID,     TerminalTEXT,     Done,     Busy,     Error,     ErrorID);</pre>

## Variables

Name	Meaning	I/O	Description	Valid range	Unit	Default
TID	Terminal number	Input	Equipment terminal number	16#00 to 16#01	---	16#00
TerminalTEXT	Send text string		Equipment terminal service data (text string) to send to host	241 bytes max. (including final NULL)*1		"

\*1. The maximum number of characters is set on the SECS/GEM Configurator. The maximum number of bytes is the maximum number of characters including the final NULL character plus 1.

	Boolean	Bit strings					Integers							Real numbers		Times, durations, dates, and text strings				
	BOOL	BYTE	WORD	DWORD	LWORD	USINT	UINT	UDINT	ULINT	SINT	INT	DINT	LINT	REAL	LREAL	TIME	DATE	TOD	DT	STRING
TID		OK																		
TerminalTEXT																				OK

## Function

The GEM\_SendTerminalMsg instruction sends an equipment terminal message to the host to display the message specified with send text string *TerminalTEXT* at the terminal specified with terminal number *TID*.

The meanings of the values of *TID* are given in the following table.

Value of <i>TID</i>	Meaning
16#00	Main terminal
16#01	Additional terminal

The result of sending the equipment terminal message to the host is stored in the *\_GEM\_EquipTerminalMsgRslt* system-defined variable.

## Additional Information

- This instruction uses the Operator Sends Information to Host scenario for the GEM Equipment Terminal Services capability.
- A SECS message is sent if this instruction is executed and execution ends normally. The SECS message exchange between the equipment and host is given below.

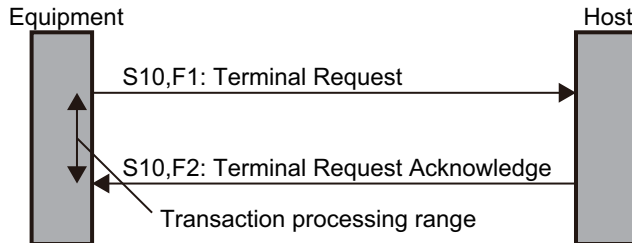

## Related System-defined Variables

Name	Meaning	Data type	Description
_GEM_BusyEquip TerminalMsg	Equipment-initiated Terminal Message Transaction Processing Flag	BOOL	Gives the processing status of an equipment-initiated terminal message transaction. *1 TRUE: Processing FALSE: Not processing
_GEM_EquipTerminal MsgRslt	Equipment-initiated Terminal Message Results	_sGEM_RSLT	Gives the results of an equipment-initiated terminal message. Refer to P. A-224 for details.
_GEM_ServiceStatus	GEM Service Status	_sGEM_SERVICE_STATUS	Gives the GEM Service status. Refer to P. A-212 for details.

\*1. This variable changes to TRUE when the instruction ends normally. It changes to FALSE when transaction processing is completed.

## Related Error Codes

Error code	Name	Description
16#3829	TID Out of Range	The value of <i>TID</i> is outside of the valid range.
16#3820	Too Many Characters	The number of characters stored in <i>Terminal/TEXT</i> exceeded the size set on the SECS/GEM Configurator.
16#041D	Exceeded Simultaneous Instruction Executed Resources	The number of simultaneously executed GEM instructions exceeded the limit.
16#3822	Set to Disable	The instruction was executed when it was disabled on the SECS/GEM Configurator.
16#3810	GEM Service Status in Initializing	The instruction was executed when the GEM Service status was Initializing.
16#3811	GEM Service Status in EQStarting	The instruction was executed when the GEM Service status was EQStarting.
16#3812	GEM Service Status in EQInitializing	The instruction was executed when the GEM Service status was EQInitializing.
16#3814	GEM Service Status in Stop	The instruction was executed when the GEM Service status was Stop.
16#3815	GEM Service Status in Error	The instruction was executed when the GEM Service status was Error.

Error code	Name	Description
16#3816	GEM Service Status in ShuttingDown	The instruction was executed when the GEM Service status was ShuttingDown.
16#3817	GEM Service Status in Shutdown	The instruction was executed when the GEM Service status was Shutdown.
16#3819	Multi-execution of Instructions	Transaction processing is not completed for a previous execution of the same instruction.
16#381B	Insufficient Transaction Resource	When the instruction was executed, the limit to the number of transactions that can be buffered had been reached.

### Precautions for Correct Use

- Before executing the instruction, confirm that all of the following conditions are met. If the instruction is executed when any of these conditions is not met, an error will occur and *Error* will change to TRUE.
  - a) *\_GEM\_ServiceStatus* must be *EQRun*.
  - b) The value specified in the *TID* input variable must be within the valid range.
  - c) The number of characters specified in the *TerminalTEXT* input variable must be equal or less than the number of characters that was set on the SECS/GEM Configurator.
- Access *\_GEM\_EquipTerminalMsgRslt* after *\_GEMBusyEquipTerminalMsg* changes from TRUE to FALSE.

### Application Procedure

Use the following procedure for this instruction.

- 1** Sending the Equipment Terminal Message  
 Do the following and then execute the instruction. The equipment terminal message is sent to the host.
  - Store the equipment terminal number in the *TID* input variable.
  - Store the message to display on the terminal in the *TerminalTEXT* input variable.
- 2** Confirming the Result of Sending the Equipment Terminal Message  
 Check the result of sending the equipment terminal message in *GEM\_EquipTerminalMsgRslt* after *\_GEM\_BusyEquipTerminalMsg* changes to FALSE.

### Sample Programming

This sample sends an equipment terminal message to the host.

The equipment terminal message is to display “ABC” on the equipment with terminal number 0.

If the GEM Service status is EQRun and the *SendTerminalMsg\_Start* internal variable changes from FALSE to TRUE, the equipment terminal message is sent.

# LD

Internal Variables	Variable	Data type	Initial value	Comment
	SendTerminalMsg_Start	BOOL	FALSE	Flag to start sending the equipment terminal message
	SendTerminalMsg_instance	GEM_SendTerminalMsg		Instance of GEM_SendTerminalMsg instruction
	SendTerminalMsg_WaitResp	BOOL	FALSE	Flag that indicates waiting for completion of equipment terminal message send
	SendTerminalMsg_Complete	BOOL	FALSE	Flag that indicates completion of equipment terminal message send
	varTID	BYTE	0	Terminal number
	varTerminalText	STRING[241]	NULL	Text to send to host

External Variables	Variable	Comment
	_GEM_ServiceStatus	GEM Service status
	_GEM_BusyEquipTerminalMsg	Equipment-initiated Terminal Message Transaction Processing Flag

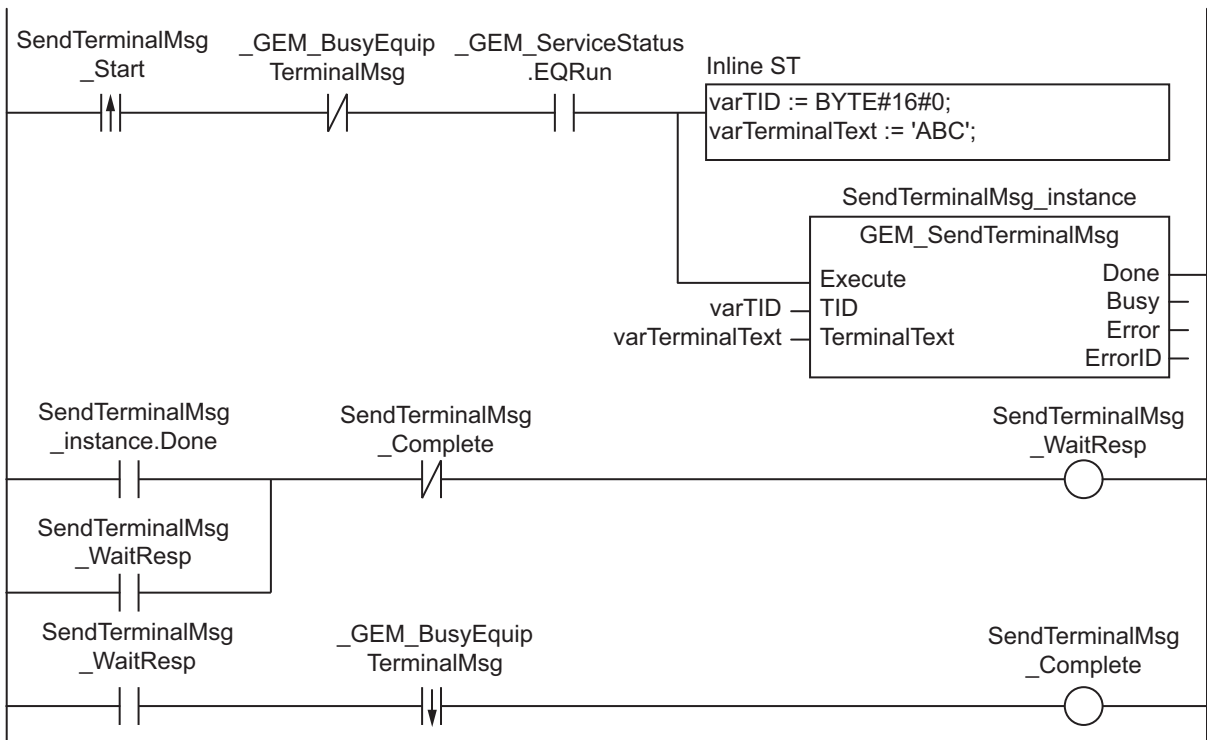

# ST

Internal Variables	Variable	Data type	Initial value	Comment
	SendTerminalMsg_Start	BOOL	FALSE	Flag to start sending the equipment terminal message
	SendTerminalMsg_instance	GEM_SendTerminalMsg		Instance of GEM_SendTerminalMsg instruction
	varTID	BYTE	0	Terminal number
	varTerminalText	STRING[241]	NULL	Text to send to host
	R_TRIG_instance	R_TRIG		Instance of R_TRIG instruction
	F_TRIG_instance	F_TRIG		Instance of F_TRIG instruction
	Trigger	BOOL	FALSE	Flag for FALSE to TRUE change in <i>SendTerminalMsg_Start</i> Flag for TRUE to FALSE change in <i>_GEM_BusyEquipTerminalMsg</i>
	Stage	INT	0	Program execution status

External Variables	Variable	Comment
	_GEM_ServiceStatus	GEM Service status
	_GEM_BusyEquipTerminalMsg	Equipment-initiated Terminal Message Transaction Processing Flag

```

CASE Stage Of
0:
  R_TRIG_instance( SendTerminalMsg_Start, Trigger );
  IF( (Trigger = TRUE) AND ( _GEM_ServiceStatus.EQRun = TRUE ) ) THEN
    // Initialization
    varTerminalText:='ABC';
    varTID := BYTE#0;
    SendTerminalMsg_instance( Execute:=FALSE );
    Stage := 1;
  END_IF;
1: // Start send.
  SendTerminalMsg_instance( Execute:=TRUE, TID :=varTID, TerminalTEXT:=varTerminalText );
  IF( SendTerminalMsg_instance.Done = TRUE ) THEN
    Stage := 2;
  ELSIF( SendTerminalMsg_instance.Error = TRUE ) THEN
    // Add error processing as required.
    Stage := 10;
  END_IF;
2: // Wait for completion of send.
  F_TRIG_instance( _GEM_BusyEquipTerminalMsg, Trigger );
  IF( Trigger = TRUE) THEN
    Stage := 10;
  END_IF;
10: // End
  Stage := 0;
END_CASE;

```

# GEM\_AckTerminalMsgSB

The GEM\_AckTerminalMsgSB instruction sends the terminal message display result for a single-block equipment terminal message received from the host.

Instruction	Name	FB/ FUN	Graphic expression	ST expression
GEM_AckTerminalMsgSB	Acknowledge Single-block Equipment Terminal Message	FB		GEM_AckTerminalMsgSB_instance( Execute, ACKC10, Done, Busy, Error, ErrorID);

## Variables

Name	Meaning	I/O	Description	Valid range	Unit	Default
ACKC10	Acknowledge code	Input	Display terminal acknowledge code. 16#00: Display acknowledged. 16#01: Message will not be displayed. 16#02: Cannot be used by terminal. 16#03 to 16#3F: Reserved.	16#00 to 16#3F	---	16#00

	Bool- ean	Bit strings					Integers							Real num- bers		Times, durations, dates, and text strings				
	BOOL	BYTE	WORD	DWORD	LWORD	USINT	UINT	UDINT	ULINT	SINT	INT	DINT	LINT	REAL	LREAL	TIME	DATE	TOD	DT	STRING
ACKC10		OK																		

## Function

The GEM\_AckTerminalMsgSB instruction sends the result of displaying a message on the specified terminal for a single-block equipment terminal message from the host. The following are required for the reply.

- Acknowledge code  
This is the result of determining whether equipment terminal message display is possible.

Refer to the application procedure for this instruction for the processing to return the message display result to the specified terminal.

### Additional Information

- This instruction uses the Host Sends Information to Equipment Display Device scenario for the GEM Equipment Terminal Services capability.
- A SECS message is sent if this instruction is executed and execution ends normally. The SECS message exchange between the equipment and host is given below.

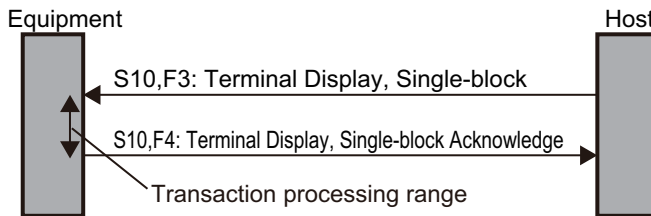

### Related System-defined Variables

Name	Meaning	Data type	Description
_GEM_BusyHostTerminalMsgSB	Host-initiated Single-block Terminal Message Transaction Processing Flag	BOOL	Gives the processing status of a host-initiated single-block terminal message transaction.*1 TRUE: Processing FALSE: Not processing
_GEM_HostTerminalMsgSB_TID	Host-initiated Single-block Terminal Message Receiving Terminal Number	BYTE	Gives the receiving terminal number for a host-initiated single-block terminal message. 0: Main terminal, 1: Additional terminal
_GEM_ServiceStatus	GEM Service Status	_sGEM_SERVICE_STATUS	Gives the GEM Service status. Refer to P. A-212 for details.

\*1. This variable changes to TRUE when Terminal Display, Single-block (S10,F3) is received from the host. It will change to FALSE when execution of the instruction is completed normally.

### Related User-defined Variables

Name	Description	SECS/GEM Configurator setting
Single-block Terminal Message Display Text	Stores the single-block terminal message display text received from the host.	Equipment Terminal Service

### Related Error Codes

Error code	Name	Description
16#3835	ACKC10 Out of Range	The value of ACKC10 is outside of the valid range.
16#041D	Exceeded Simultaneous Instruction Executed Resources	The number of simultaneously executed GEM instructions exceeded the limit.
16#3810	GEM Service Status in Initializing	The instruction was executed when the GEM Service status was Initializing.
16#3811	GEM Service Status in EQStarting	The instruction was executed when the GEM Service status was EQStarting.
16#3812	GEM Service Status in EQInitializing	The instruction was executed when the GEM Service status was EQInitializing.

Error code	Name	Description
16#3814	GEM Service Status in Stop	The instruction was executed when the GEM Service status was Stop.
16#3815	GEM Service Status in Error	The instruction was executed when the GEM Service status was Error.
16#3816	GEM Service Status in ShuttingDown	The instruction was executed when the GEM Service status was ShuttingDown.
16#3817	GEM Service Status in Shutdown	The instruction was executed when the GEM Service status was Shutdown.
16#3818	No Message Received	The instruction was executed without receiving a single-block equipment terminal message.

## Precautions for Correct Use

- Before executing the instruction, confirm that all of the following conditions are met. If the instruction is executed when any of these conditions is not met, an error will occur and *Error* will change to TRUE.
  - a) *\_GEM\_ServiceStatus* must be *EQRun*.
  - b) The value specified in the *ACKC10* input variable must be within the valid range.
  - c) *\_GEM\_BusyHostTerminalMsgSB* must be TRUE.
- In the following cases, the *\_GEM\_BusyHostTerminalMsgSB* system-defined variable does not change to TRUE even if a Terminal Display, Single-block (S10,F3) is received.
  - a) Terminal Display, Single-block (S10,F3) is disabled in the GEM message settings on the SECS/GEM Configurator.

## Application Procedure

Use the following procedure for this instruction.

- 1** Detecting the Equipment Terminal Message from Host  
 Confirm that *\_GEM\_BusyHostTerminalMsgSB* changes from FALSE to TRUE.  
 The message to the terminal is stored in the following variables.
  - Single-block Terminal Message Display Text
  - *\_GEM\_HostTerminalMsgSB\_TID*
- 2** Determining Whether Equipment Terminal Message Display Is Possible  
 Determine if it is possible to display an equipment terminal message on the terminal with the terminal number specified by *\_GEM\_HostTerminalMsgSB\_TID*. Examples of the criteria are given below.
  - Can a message be displayed on the terminal?  
 If the message cannot be displayed, the acknowledge code is 16#01.
  - Can the terminal be used?  
 If the terminal cannot be used, the acknowledge code is 16#02.
 If a message can be displayed and the terminal can be used, the acknowledge code is 16#00.
- 3** Sending the Display Result for the Equipment Terminal Message Display Request  
 Specify the acknowledge code for the above result in the *ACKC10* input variable and execute the instruction. The equipment terminal message display result is sent to the host as the reply.
- 4** Displaying the Equipment Terminal Message



If the message can be displayed at the specified terminal, perform processing to display the message in *Single-block Terminal Message Display Text* at the specified terminal.

## Sample Programming

This sample determines if displaying a message is possible for a single-block equipment terminal message from the host and sends the terminal message display result to the host.

### SECS/GEM Configurator

First, the relevant variables are registered on the SECS/GEM Configurator.

Only the items that are related to the GEM\_AckTerminalMsgSB instruction are given in the following table.

#### ● Equipment Terminal Service – Operation Settings

Item	Set value
Number of terminals	1
Link variable for displayed TEXT of single-block terminal messages - Displayed TEXT	TERMINAL_MSG_SB_TEXT

Next, enter the programming on the Sysmac Studio.

### LD

Internal Variables	Variable	Data type	Initial value	Comment
	AckTerminalMsgSB_ACKC10	BYTE	0	Acknowledge code
	AckTerminalMsgSB_instance	GEM_AckTerminalMsgSB		Instance of GEM_AckTerminalMsgSB instruction

External Variables	Variable	Comment
	_GEM_ServiceStatus	GEM Service status
	_GEM_BusyHostTerminalMsgSB	Host-initiated Single-block Terminal Message Transaction Processing Flag
	TERMINAL_MSG_SB_TEXT	Link variable for displayed TEXT of single-block terminal messages - Displayed TEXT

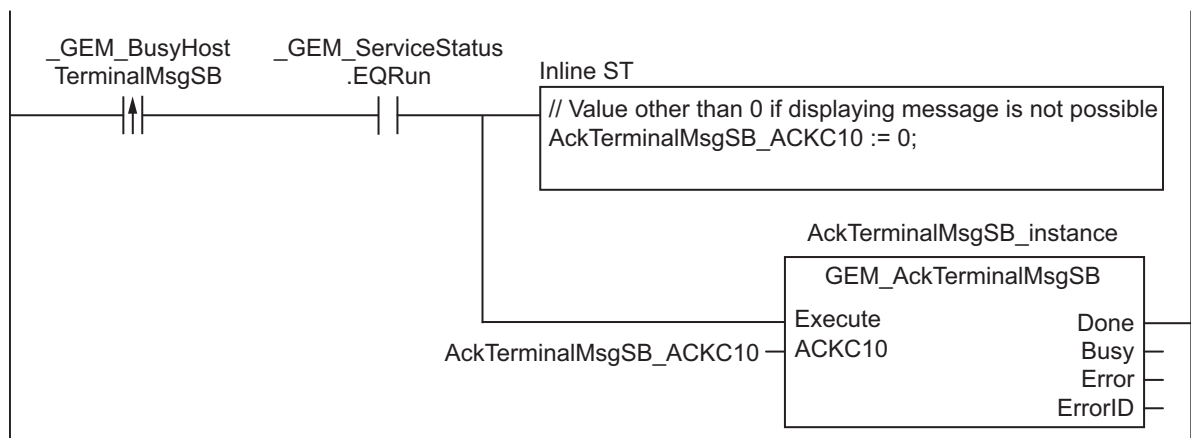

# ST

Internal Variables	Variable	Data type	Initial value	Comment
	AckTerminalMsgSB_ACKC10	BYTE	0	Acknowledge code
	AckTerminalMsgSB_instance	GEM_AckTerminalMsgSB		Instance of GEM_AckTerminalMsgSB instruction
	R_TRIG_instance	R_TRIG		Instance of R_TRIG instruction
	Trigger	BOOL	FALSE	Flag for FALSE to TRUE change in <i>_GEM_BusyHostTerminalMsgSB</i>
	Stage	INT	0	Program execution status

External Variables	Variable	Comment
	<i>_GEM_ServiceStatus</i>	GEM Service status
	<i>_GEM_BusyHostTerminalMsgSB</i>	Host-initiated Single-block Terminal Message Transaction Processing Flag

```

CASE Stage Of
0: // Notification of reception from host
  R_TRIG_instance( _GEM_BusyHostTerminalMsgSB, Trigger );
  IF( Trigger = TRUE ) THEN
    // Judgement
    AckTerminalMsgSB_ACKC10:=BYTE#0;
    // Initialization
    AckTerminalMsgSB_instance( Execute:=FALSE );
    Stage := 1;
  END_IF;
1:// Reply to host.
  AckTerminalMsgSB_instance( Execute:=TRUE, ACKC10:=AckTerminalMsgSB_ACKC10 );
  IF( AckTerminalMsgSB_instance.Done = TRUE ) THEN
    Stage := 10;
  ELSIF( AckTerminalMsgSB_instance.Error = TRUE ) THEN
    // Add error processing as required.
    Stage := 10;
  END_IF;
10: // End
  Stage := 0;
END_CASE;

```

# GEM\_AckTerminalMsgMB

The GEM\_AckTerminalMsgMB instruction sends the terminal message display result for a multi-block equipment terminal message received from the host.

Instruction	Name	FB/ FUN	Graphic expression	ST expression
GEM_AckTerminalMsgMB	Acknowledge Multi-block Equipment Terminal Message	FB		GEM_AckTerminalMsgMB_instance(  Execute, ACKC10, Done, Busy, Error, ErrorID);

## Variables

Name	Meaning	I/O	Description	Valid range	Unit	Default
ACKC10	Acknowledge Code	Input	Display terminal acknowledge code. 16#00: Display acknowledged. 16#01: Message will not be displayed. 16#02: Cannot be used by terminal. 16#03 to 16#3F: Reserved.	16#00 to 16#3F	---	16#00

	Boolean	Bit strings				Integers							Real numbers		Times, durations, dates, and text strings					
	BOOL	BYTE	WORD	DWORD	LWORD	USINT	UINT	UDINT	ULINT	SINT	INT	DINT	LINT	REAL	LREAL	TIME	DATE	TOD	DT	STRING
ACKC10		OK																		

## Function

The GEM\_AckTerminalMsgMB instruction sends the result of displaying a message on the specified terminal for a multi-block equipment terminal message from the host. The following are required for the reply.

- Acknowledge code  
This is the result of determining whether equipment terminal message display is possible.

Refer to the application procedure for this instruction for the processing to return the message display result to the specified terminal.

## Additional Information

- This instruction uses the Host Sends a Multi-block Display Message scenario for the GEM Equipment Terminal Services capability.
- A SECS message is sent if this instruction is executed and execution ends normally. The SECS message exchange between the equipment and host is given below.

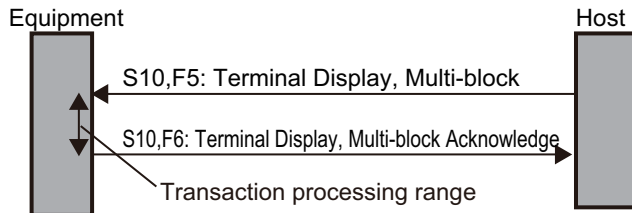

## Related System-defined Variables

Name	Meaning	Data type	Description
_GEM_BusyHostTerminalMsgMB	Host-initiated Multi-block Terminal Message Transaction Processing Flag	BOOL	Gives the processing status of a host-initiated multi-block terminal message transaction. <sup>*1</sup> TRUE: Processing FALSE: Not processing
_GEM_HostTerminalMsgMB_TID	Host-initiated Multi-block Terminal Message Receiving Terminal Number	BYTE	Gives the receiving terminal number for a host-initiated multi-block terminal message. 0: Main terminal, 1: Additional terminal
_GEM_ServiceStatus	GEM Service Status	_sGEM_SERVICE_STATUS	Gives the GEM Service status. Refer to P. A-212 for details.

\*1. This variable changes to TRUE when Terminal Display, Multi-block (S10,F5) is received from the host. It will change to FALSE when execution of the instruction is completed normally.

## Related User-defined Variables

Name	Description	SECS/GEM Configurator setting
Multi-block Terminal Message Display Number of Text Strings	Contains the number of message text strings to display on the terminal.	Equipment Terminal Service
Multi-block Terminal Message Display Text Table	Stores the multi-block terminal message display text received from the host.	

## Related Error Codes

Error code	Name	Description
16#3835	ACKC10 Out of Range	The value of ACKC10 is outside of the valid range.
16#041D	Exceeded Simultaneous Instruction Executed Resources	The number of simultaneously executed GEM instructions exceeded the limit.

Error code	Name	Description
16#3810	GEM Service Status in Initializing	The instruction was executed when the GEM Service status was Initializing.
16#3811	GEM Service Status in EQStarting	The instruction was executed when the GEM Service status was EQStarting.
16#3812	GEM Service Status in EQInitializing	The instruction was executed when the GEM Service status was EQInitializing.
16#3814	GEM Service Status in Stop	The instruction was executed when the GEM Service status was Stop.
16#3815	GEM Service Status in Error	The instruction was executed when the GEM Service status was Error.
16#3816	GEM Service Status in ShuttingDown	The instruction was executed when the GEM Service status was ShuttingDown.
16#3817	GEM Service Status in Shutdown	The instruction was executed when the GEM Service status was Shutdown.
16#3818	No Message Received	The instruction was executed without receiving a multi-block equipment terminal message.

### Precautions for Correct Use

- Before executing the instruction, confirm that all of the following conditions are met. If the instruction is executed when any of these conditions is not met, an error will occur and Error will change to TRUE.
  - a) *\_GEM\_ServiceStatus* must be *EQRun*.
  - b) The value specified in the *ACKC10* input variable must be within the valid range.
  - c) *\_GEM\_BusyHostTerminalMsgMB* must be TRUE.
- In the following cases, the *\_GEM\_BusyHostTerminalMsgMB* system-defined variable does not change to TRUE even if a Terminal Display, Multi-block (S10,F5) is received.
  - a) Terminal Display, Multi-block (S10,F5) is disabled in the GEM message settings on the SECS/GEM Configurator.

### Application Procedure

Use the following procedure for this instruction.

- 1** Detecting the Equipment Terminal Message from Host  
 Confirm that *\_GEM\_BusyHostTerminalMsgMB* changes from FALSE to TRUE.  
 The message to the terminal is stored in the following variables.
  - Multi-block Terminal Message Display Text Table
  - Multi-block Terminal Message Display Number of Text Strings
  - *\_GEM\_HostTerminalMsgSB\_TID*
- 2** Determining Whether Equipment Terminal Message Display Is Possible  
 Determine if it is possible to display an equipment terminal message on the terminal with the terminal number specified by *\_GEM\_HostTerminalMsgMB\_TID*. Examples of the criteria are given below.
  - Can a message be displayed on the terminal?  
 If the message cannot be displayed, the acknowledge code is 16#01.
  - Can the terminal be used?  
 If the terminal cannot be used, the acknowledge code is 16#02.

If a message can be displayed and the terminal can be used, the acknowledge code is 16#00.

**3** Returning the Equipment Terminal Message Display Result

Specify the acknowledge code from step 2 in the *ACKC10* input variable and execute the instruction. The equipment terminal message display result is sent to the host as the reply.

**4** Displaying the Equipment Terminal Message

If the message can be displayed on the specified terminal, perform processing to display the messages in *Multi-block Terminal Message Display Text Table* for the number of strings specified in *Multi-block Terminal Message Display Number of Text Strings* on the terminal with the specified terminal number.

## Sample Programming

This sample determines if displaying a message is possible for a multi-block equipment terminal message from the host and sends the terminal message display result to the host.

### SECS/GEM Configurator

First, the relevant variables are registered on the SECS/GEM Configurator.

Only the items that are related to the *GEM\_AckTerminalMsgMB* instruction are given in the following table.

● **Equipment Terminal Service – Operation Settings**

Item	Set value
Number of terminals	1
Number of messages displayed on terminals	10
Link variable for displayed TEXT of multi-block terminal messages – Displayed TEXT Count	TERMINAL_MSG_MB_NUMBER
Link variable for displayed TEXT of multi-block terminal messages – Displayed TEXT Table	TERMINAL_MSG_MB_TABLE

Next, enter the programming on the Sysmac Studio.

### LD

Internal Variables	Variable	Data type	Initial value	Comment
	AckTerminalMsgMB_ACKC10	BYTE	0	Acknowledge code
	AckTerminalMsgMB_instance	GEM_AckTerminalMsgMB		Instance of GEM_AckTerminalMsgMB instruction

External Variables	Variable	Comment
	_GEM_ServiceStatus	GEM Service status
	_GEM_BusyHostTerminalMsgMB	Host-initiated Multi-block Terminal Message Transaction Processing Flag
	TERMINAL_MSG_MB_NUMBER	Link variable for displayed TEXT of multi-block terminal messages – Displayed TEXT Count

External Variables	Variable	Comment
	TERMINAL_MSG_MB_TABLE	Link variable for displayed TEXT of multi-block terminal messages – Displayed TEXT Table

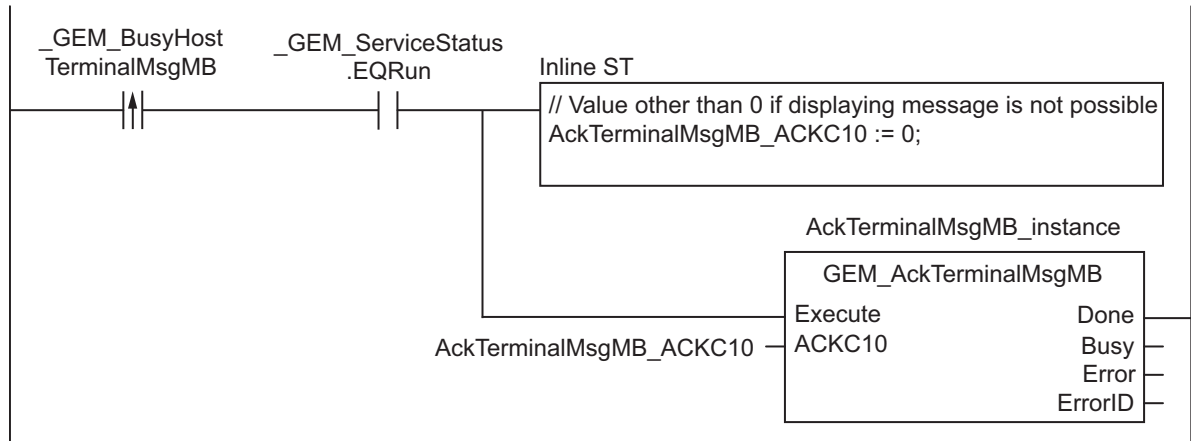

**ST**

Internal Variables	Variable	Data type	Initial value	Comment
	AckTerminalMsgMB_ACKC10	BYTE	0	Acknowledge code
	AckTerminalMsgMB_instance	GEM_AckTerminalMsgMB		Instance of GEM_AckTerminalMsgMB instruction
	R_TRIG_instance	R_TRIG		Instance of R_TRIG instruction
	Trigger	BOOL	FALSE	Flag for FALSE to TRUE change in <u>_GEM_BusyHostTerminalMsgMB</u>
	Stage	INT	0	Program execution status

External Variables	Variable	Comment
	_GEM_BusyHostTerminalMsgMB	Host-initiated Multi-block Terminal Message Transaction Processing Flag

```

CASE Stage Of
0: // Notification of reception from host
  R_TRIG_instance( _GEM_BusyHostTerminalMsgMB, Trigger );
  IF( Trigger = TRUE ) THEN
    // Judgement
    AckTerminalMsgMB_ACKC10:=BYTE#0;
    // Initialization
    AckTerminalMsgMB_instance( Execute:=FALSE );
    Stage := 1;
  END_IF;
1:// Reply to host.
  AckTerminalMsgMB_instance( Execute:=TRUE, ACKC10:=AckTerminalMsgMB_ACKC10 );
  IF( AckTerminalMsgMB_instance.Done = TRUE ) THEN
    Stage := 10;
  ELSIF( AckTerminalMsgMB_instance.Error = TRUE ) THEN
    // Add error processing as required.

```

```
        Stage := 10;  
    END_IF;  
10: // End  
    Stage := 0;  
END_CASE;
```



# GEM\_RequestChangeTime

The GEM\_RequestChangeTime instruction gets the time from the host and changes the controller time.

Instruction	Name	FB/ FUN	Graphic expression	ST expression
GEM_Request ChangeTime	Request Time Change	FB		<pre>GEM_RequestChangeTime_in- stance(     Execute,     Done,     Busy,     Error,     ErrorID);</pre>

## Variables

Only common variables are used.

## Function

The GEM\_RequestChangeTime instruction gets the time from the host and changes the controller time. The result of the time change is stored in the `_GEM_EquipChangeTimeRslt` system-defined variable.

## Additional Information

- This instruction uses the Equipment Requests Time scenario for the GEM Clock capability.
- A SECS message is sent if this instruction is executed and execution ends normally. The SECS message exchange between the equipment and host is given below.

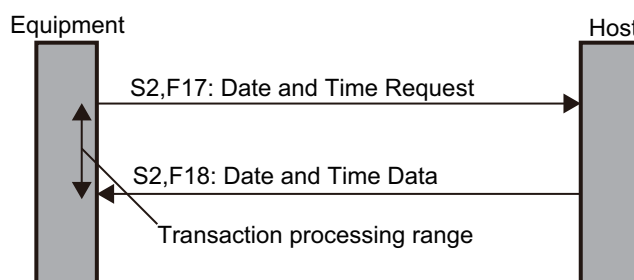

## Related System-defined Variables

Name	Meaning	Data type	Description
<code>_GEM_BusyEquipChan- geTime</code>	Equipment-initiated Time Change Request Transaction Processing Flag	BOOL	Gives the processing status of an equipment-initiated time change request transaction. *1 TRUE: Processing FALSE: Not processing

Name	Meaning	Data type	Description
_GEM_EquipChangeTimeRslt	Equipment-initiated Time Change Result	_sGEM_RS LT	Gives the results of an equipment-initiated time change.  Refer to P. A-227 for details.
_GEM_ServiceStatus	GEM Service Status	_sGEM_- SER- VICE_STAT US	Gives the GEM Service status.  Refer to P. A-212 for details.

\*1. This variable changes to TRUE if the instruction ends normally. This variable changes to FALSE when the equipment-initiated time change transaction is completed.

## Related Error Codes

Error code	Name	Description
16#041D	Exceeded Simultaneous Instruction Executed Resources	The number of simultaneously executed GEM instructions exceeded the limit.
16#3810	GEM Service Status in Initializing	The instruction was executed when the GEM Service status was Initializing.
16#3811	GEM Service Status in EQStarting	The instruction was executed when the GEM Service status was EQStarting.
16#3812	GEM Service Status in EQInitializing	The instruction was executed when the GEM Service status was EQInitializing.
16#3814	GEM Service Status in Stop	The instruction was executed when the GEM Service status was Stop.
16#3815	GEM Service Status in Error	The instruction was executed when the GEM Service status was Error.
16#3816	GEM Service Status in ShuttingDown	The instruction was executed when the GEM Service status was ShuttingDown.
16#3817	GEM Service Status in Shutdown	The instruction was executed when the GEM Service status was Shutdown.
16#3819	Multi-execution of Instructions	Transaction processing is not completed for a previous execution of the same instruction.
16#381B	Insufficient Transaction Resource	When the instruction was executed, the limit to the number of transactions that can be buffered had been reached.

## Precautions for Correct Use

- Before executing the instruction, confirm that all of the following conditions are met. If the instruction is executed when any of these conditions is not met, an error will occur and *Error* will change to TRUE.
  - a) *\_GEM\_ServiceStatus* must be *EQRun*.
  - b) *\_GEM\_BusyEquipChangeTime* must be FALSE.
- Access *\_GEM\_EquipChangeTimeRslt* after *\_GEM\_BusyEquipChangeTime* changes from TRUE to FALSE.

## Sample Programming

This sample gets the time from the host and changes the controller time.

If the GEM Service status is EQRun and the *RequestChangeTime\_Start* internal variable changes from FALSE to TRUE, the controller time is changed.

**LD**

Internal Variables	Variable	Data type	Initial value	Comment
	RequestChangeTime_Start	BOOL	FALSE	Flag to start time change
	RequestChangeTime_instance	GEM_RequestChangeTime		Instance of GEM_RequestChangeTime instruction
	RequestChangeTime_WaitResp	BOOL	FALSE	Flag that indicates waiting for completion of time change
	RequestChangeTime_Complete	BOOL	FALSE	Flag that indicates completion of time change

External Variables	Variable	Comment
	_GEM_ServiceStatus	GEM Service status
	_GEM_BusyEquipChangeTime	Equipment-initiated Time Change Request Transaction Processing Flag

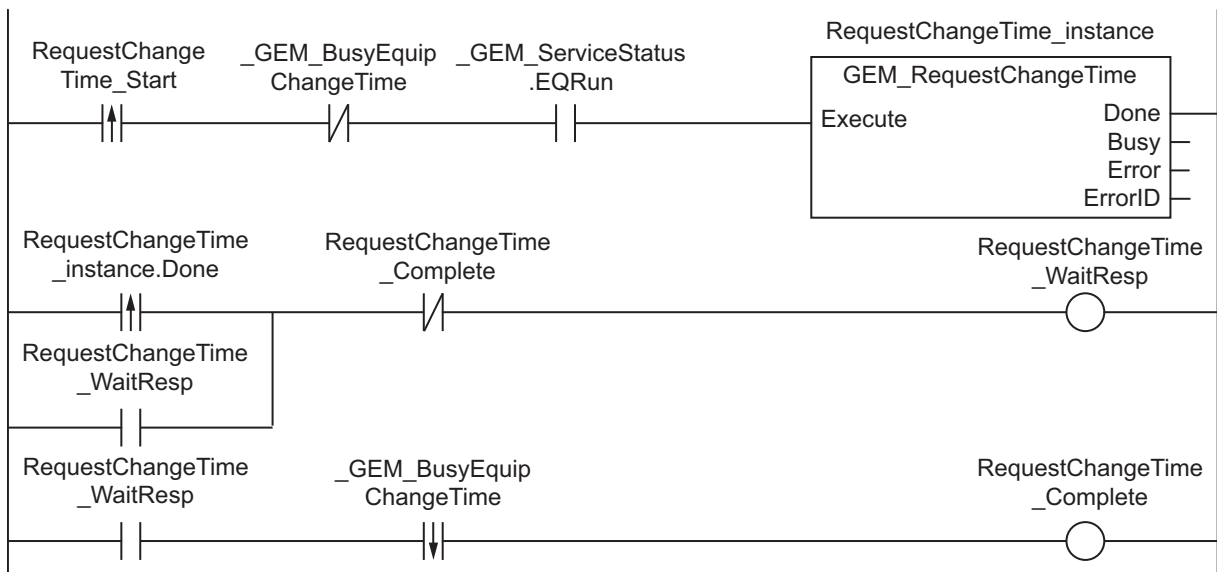

# ST

Internal Variables	Variable	Data type	Initial value	Comment
	RequestChangeTime_Start	BOOL	FALSE	Flag to start time change
	RequestChangeTime_ instance	GEM_RequestChangeTime		Instance of GEM_RequestChangeTime instruction
	R_TRIG_instance	R_TRIG		Instance of R_TRIG instruction
	F_TRIG_instance	F_TRIG		Instance of F_TRIG instruction
	Trigger	BOOL	FALSE	Flag for FALSE to TRUE change in <i>RequestChangeTime_Start</i> Flag for TRUE to FALSE change in <i>_GEM_BusyEquipChangeTime</i>
	Stage	INT	0	Program execution status

External Variables	Variable	Comment
	_GEM_ServiceStatus	GEM Service status
	_GEM_BusyEquipChangeTime	Equipment-initiated Time Change Request Transaction Processing Flag

```

CASE Stage Of
0: // Start
  R_TRIG_instance( RequestChangeTime_Start, Trigger );
  IF( (Trigger = TRUE) AND ( _GEM_ServiceStatus.EQRun = TRUE ) ) THEN
    // Initialization
    RequestChangeTime_instance( Execute:=FALSE );
    Stage := 1;
  END_IF;
1: // Request time change.
  RequestChangeTime_instance( Execute:=TRUE );
  IF( RequestChangeTime_instance.Done = TRUE ) THEN
    Stage := 2;
  ELSIF( RequestChangeTime_instance.Error = TRUE ) THEN
    // Add error processing as required.
    Stage := 10;
  END_IF;
2: // Wait for completion of change.
  F_TRIG_instance( _GEM_BusyEquipChangeTime, Trigger );
  IF( Trigger = TRUE) THEN
    Stage := 10;
  END_IF;
10: // End
  Stage := 0;
END_CASE;

```

# GEM\_SendEquipUserMsg

The GEM\_SendEquipUserMsg sends a user-defined message to the host.

Instruction	Name	FB/ FUN	Graphic expression	ST expression
GEM_SendEquipUserMsg	Send Equipment-initiated User-defined Message	FB		GEM_SendEquipUserMsg_instance(  Execute, MsgNo, Done, Busy, Error, ErrorID);

## Variables

Name	Meaning	I/O	Description	Valid range	Unit	Default
MsgNo	Message number	Input	User-defined message number	Depends on data type.	---	*1

\*1. If you omit an input parameter, the default value is not applied. A building error will occur.

	Boolean	Bit strings				Integers						Real numbers		Times, durations, dates, and text strings						
	BOOL	BYTE	WORD	DWORD	LWORD	USINT	UINT	UDINT	ULINT	SINT	INT	DINT	LINT	REAL	LREAL	TIME	DATE	TOD	DT	STRING
MsgNo						OK	OK			OK	OK									

## Function

The GEM\_SendEquipUserMsg instruction sends the user-defined message specified with message number *MsgNo* to the host.

The result of sending the user-defined message is stored in *\_GEM\_EquipUserMsgRslt*.

## Additional Information

- A SECS message is sent if this instruction is executed and execution ends normally. The SECS message exchange between the equipment and host is given below.

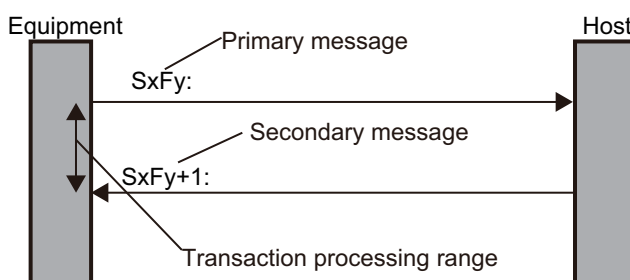

## Related System-defined Variables

Name	Meaning	Data type	Description
_GEM_BusyEquipUserMsg	Equipment-initiated User-defined Message Transaction Processing Flag	BOOL	Gives the processing status of an equipment-initiated user-defined message transaction.*1 *2 TRUE: Processing FALSE: Not processing
_GEM_EquipUserMsgNo	Equipment-initiated User-defined Message Number	UINT	Gives the number of a received equipment-initiated user-defined message.
_GEM_EquipUserMsgRslt	Equipment-initiated User-defined Message Results	_sGEM_RSLT	Gives the results of an equipment-initiated user-defined message. Refer to P. A-228 for details.
_GEM_ServiceStatus	GEM Service Status	_sGEM_SERVICE_STATUS	Gives the GEM Service status. Refer to P. A-212 for details.

\*1. This variable changes to TRUE when the instruction ends normally. It changes to FALSE when transaction processing is completed.

\*2. If you specify on the SECS/GEM Configurator that a reply for the primary message is not necessary and then execute the instruction with the *MsgNo* input variable set to 0, this variable changes to FALSE.

## Related Error Codes

Error code	Name	Description
16#041D	Exceeded Simultaneous Instruction Executed Resources	The number of simultaneously executed GEM instructions exceeded the limit.
16#3822	Set to Disable	A message number that was disabled on the SECS/GEM Configurator was specified in <i>MsgNo</i> .
16#3827	Undefined Message Number	A message number that was not defined in user-defined messages on the SECS/GEM Configurator was specified in <i>MsgNo</i> .
16#3838	Illegal SECS Message	A message number for which an even function number is registered was specified in <i>MsgNo</i> .
16#3810	GEM Service Status in Initializing	The instruction was executed when the GEM Service status was Initializing.
16#3811	GEM Service Status in EQStarting	The instruction was executed when the GEM Service status was EQStarting.
16#3812	GEM Service Status in EQInitializing	The instruction was executed when the GEM Service status was EQInitializing.
16#3814	GEM Service Status in Stop	The instruction was executed when the GEM Service status was Stop.
16#3815	GEM Service Status in Error	The instruction was executed when the GEM Service status was Error.
16#3816	GEM Service Status in ShuttingDown	The instruction was executed when the GEM Service status was ShuttingDown.
16#3817	GEM Service Status in Shutdown	The instruction was executed when the GEM Service status was Shutdown.
16#3819	Multi-execution of Instructions	Transaction processing is not completed for a previous execution of the same instruction.

Error code	Name	Description
16#381B	Insufficient Transaction Resource	When the instruction was executed, the limit to the number of transactions that can be buffered had been reached.

### Precautions for Correct Use

- Before executing the instruction, confirm that all of the following conditions are met. If the instruction is executed when any of these conditions is not met, an error will occur and *Error* will change to TRUE.
  - a) *\_GEM\_ServiceStatus* must be *EQRun*.
  - b) *\_GEM\_BusyEquipUserMsg* must be *FALSE*.
- Access *\_GEM\_EquipUserMsgRslt* after *\_GEM\_BusyEquipUserMsg* changes from *TRUE* to *FALSE*.

### Application Procedure

Use the following procedure for this instruction.

- 1** Storing the Data to Send  
Store the required information in user-defined variables for the message number to send.
- 2** Sending the User-defined Message  
Specify the message number to send in the *MsgNo* input variable and execute the instruction. The user-defined message is sent to the host.
- 3** Confirming the Result of Sending the User-defined Message  
Check the result of sending the user-defined message in *GEM\_EquipUserMsgRslt* after *\_GEM\_BusyEquipUserMsg* changes to *FALSE*.

### Sample Programming

This sample sends a user-defined message.

Loopback Diagnostic Request (S2,F25) is used in this example.

A loopback message is sent and the reply data is checked.

If the GEM Service status is *EQRun* and the *SendEquipUserMsg\_Start* internal variable changes from *FALSE* to *TRUE*, a user-defined message is sent.

## SECS/GEM Configurator

First, the following user-defined messages are created on the SECS/GEM Configurator.

Message number	S/F	Branch number	Enabled/disabled	Direction	Reply	Abbreviation	Message name	Message structure	Link variable
1	S2F25	1	Enabled	H ← E	Yes	LDR	Loopback Diagnostic Request	<B>	S2F25_00001_Var
2	S2F26	1	Enabled	H → E	---	LDD	Loopback Diagnostic Data	<B>	S2F26_00002_Var

Next, enter the programming on the Sysmac Studio.

**LD**

Internal Variables	Variable	Data type	Initial value	Comment
	SendEquipUserMsg_Start	BOOL	FALSE	Flag to start sending equipment-initiated user-defined message
	SendEquipUserMsg_instance	GEM_SendEquipUserMsg		Instance of GEM_SendEquipUserMsg instruction
	SendEquipUserMsg_WaitResp	BOOL	FALSE	Flag that indicates waiting for completion of sending equipment-initiated user-defined message
	SendEquipUserMsg_Complete	BOOL	FALSE	Flag that indicates completion of sending equipment-initiated user-defined message
	varMsgNo	UINT	0	Message number
	LoopbackRslt	BOOL	FALSE	Loopback check result
	LoopbackSendData	ARRAY[0..9] OF BYTE	[16#01, 16#23, 16#45, 16#67, 16#89, 16#01, 16#23, 16#45, 16#67, 16#89]	Loopback send data

External Variables	Variable	Comment
	_GEM_ServiceStatus	GEM Service status
	_GEM_BusyEquipUserMsg	Equipment-initiated User-defined Message Transaction Processing Flag
	_GEM_EquipUserMsgRslt	Send Equipment-initiated User-defined Message Result
	_GEM_EquipUserMsgNo	Equipment-initiated User-defined Message Number
	S2F25_00001_Var	Link variable for message to send for loopback diagnosis
	S2F26_00002_Var	Link variable for message to receive for loopback diagnosis



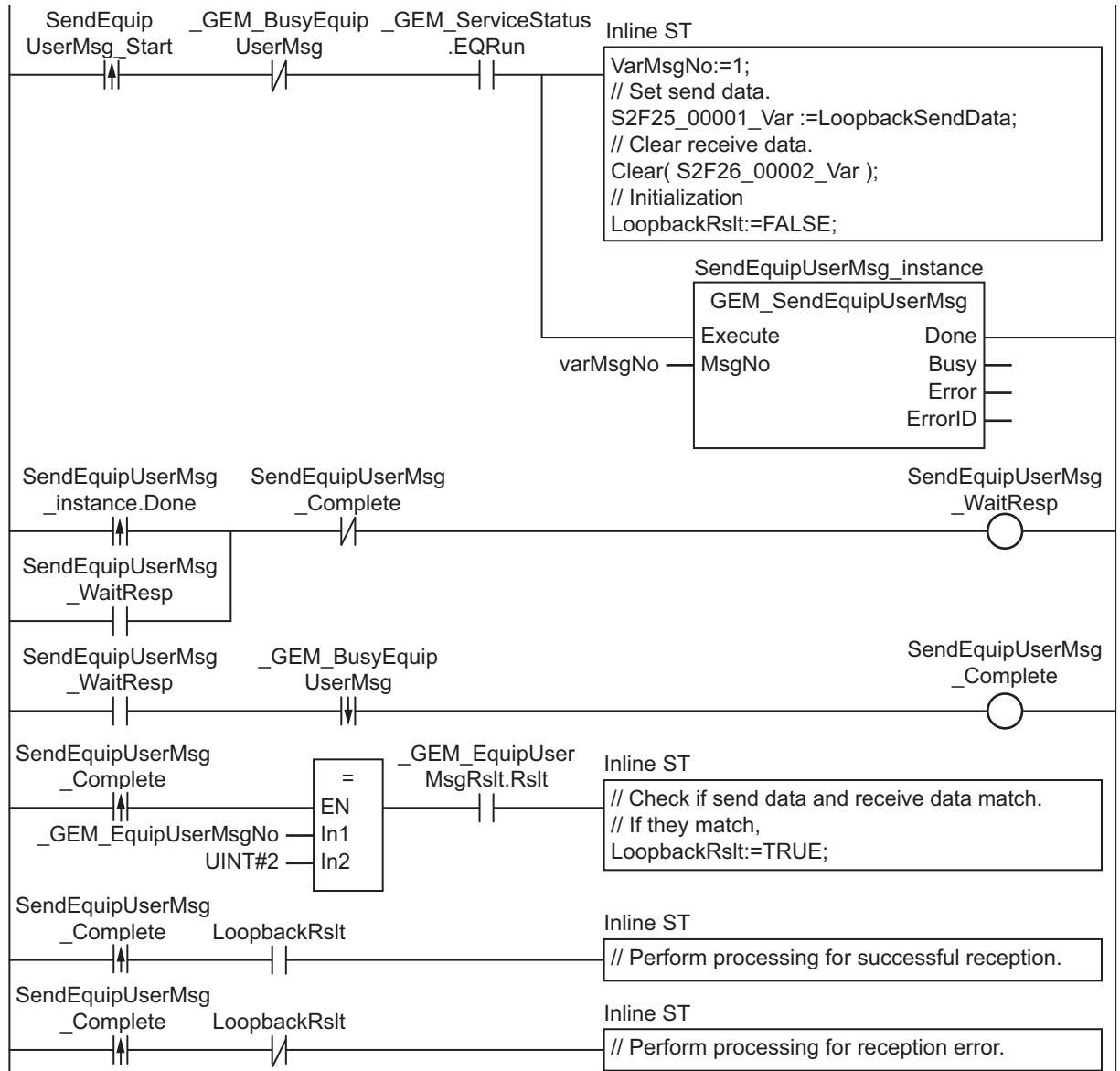

**ST**

Internal Variables	Variable	Data type	Initial value	Comment
	SendEquipUserMsg_Start	BOOL	FALSE	Flag to start sending the equipment-initiated user-defined message
	SendEquipUserMsg_instance	GEM_SendEquipUserMsg		Instance of GEM_SendEquipUserMsg instruction
	R_TRIG_instance	R_TRIG		Instance of R_TRIG instruction
	F_TRIG_instance	F_TRIG		Instance of F_TRIG instruction
	Trigger	BOOL	FALSE	Flag for FALSE to TRUE change in <i>SendEquipUserMsg_Start</i> Flag for TRUE to FALSE change in <i>_GEM_BusyEquipUserMsg</i>
	Stage	INT	0	Program execution status
	varMsgNo	UINT	0	Message number
	LoopbackRslt	BOOL	FALSE	Loopback check result
	LoopbackSendData	ARRAY[0..9] OF BYTE	[16#01, 16#23, 16#45, 16#67, 16#89, 16#01, 16#23, 16#45, 16#67, 16#89]	Loopback send data

External Variables	Variable	Comment
	_GEM_ServiceStatus	GEM Service status
	_GEM_BusyEquipUserMsg	Equipment-initiated User-defined Message Transaction Processing Flag
	_GEM_EquipUserMsgRslt	Send Equipment-initiated User-defined Message Result
	_GEM_EquipUserMsgNo	Equipment-initiated User-defined Message Number
	S2F25_00001_Var	Link variable for message to send for loopback diagnosis
	S2F26_00002_Var	Link variable for message to receive for loopback diagnosis

```

CASE Stage Of
0:
  R_TRIG_instance( SendEquipUserMsg_Start, Trigger );
  IF( (Trigger = TRUE)
    AND ( _GEM_ServiceStatus.EQRun = TRUE ) ) THEN
    VarMsgNo:=1;
    // Set send data.
    S2F25_00001_Var :=LoopbackSendData;
    // Clear receive data.
    Clear( S2F26_00002_Var );
    // Initialization
    LoopbackRslt:=FALSE;
    SendEquipUserMsg_instance( Execute:=FALSE, MsgNo:=VarMsgNo );
    Stage := 1;
  END_IF;
1: // Start send.
  SendEquipUserMsg_instance( Execute:=TRUE, MsgNo:=VarMsgNo );
  IF( SendEquipUserMsg_instance.Done = TRUE ) THEN

```

```

    Stage := 2;
ELSIF( SendEquipUserMsg_instance.Error = TRUE ) THEN
    // Add error processing as required.
    Stage := 10;
END_IF;
2: // Wait for completion of send.
F_TRIG_instance( _GEM_BusyEquipUserMsg, Trigger );
IF( Trigger = TRUE) THEN
    IF( _GEM_EquipUserMsgRslt.Rslt = TRUE AND _GEM_EquipUserMsgNo = 2 ) THEN
        // Check if send data and receive data match.
        // If they match,
        Stage := 3;
        // If they do not match,
        Stage := 4;
    ELSE
        Stage := 4;
    END_IF;
END_IF;
3: // Perform processing for successful loopback process.
    Stage := 10;
4: // Perform processing for failed loopback process.
    Stage := 10;
10: // End
    Stage := 0;
END_CASE;

```

# GEM\_RespHostUserMsg

The GEM\_RespHostUserMsg instruction returns the user-defined message with the specified message number as the reply for a user-defined message received from the host.

Instruction	Name	FB/ FUN	Graphic expression	ST expression
GEM_RespHostUserMsg	Respond to Host-initiated User-defined Message	FB		GEM_RespHostUserMsg_instance(  Execute, MsgNo, Done, Busy, Error, ErrorID);

## Variables

Name	Meaning	I/O	Description	Valid range	Unit	Default
MsgNo	Message number	Input	User-defined message number	Depends on data type.	---	*1

\*1. If you omit an input parameter, the default value is not applied. A building error will occur.

	Boolean	Bit strings				Integers							Real numbers		Times, durations, dates, and text strings					
	BOOL	BYTE	WORD	DWORD	LWORD	USINT	UINT	UDINT	ULINT	SINT	INT	DINT	LINT	REAL	LREAL	TIME	DATE	TOD	DT	STRING
MsgNo						OK	OK			OK	OK									

## Function

The GEM\_RespHostUserMsg instruction sends the user-defined secondary message with the message number specified in *MsgNo* as the reply for a user-defined primary message received from the host.

## Additional Information

- A SECS message is sent if this instruction is executed and execution ends normally. The SECS message exchange between the equipment and host is given below.

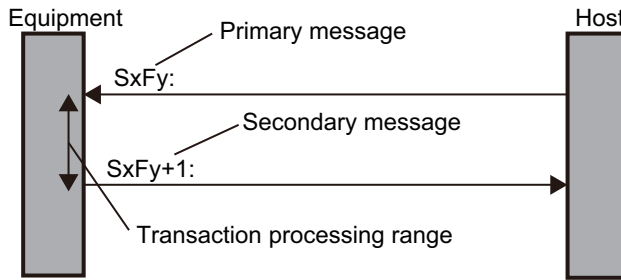

## Related System-defined Variables

Name	Meaning	Data type	Description
_GEM_BusyHostUserMsg	Host-initiated User-defined Message Transaction Processing Flag	BOOL	Gives the processing status of a host-initiated user-defined message transaction. *1 *2 TRUE: Processing FALSE: Not processing
_GEM_HostUserMsgNo	Host-initiated User-defined Message Number	UINT	Gives the number of the received host-initiated user-defined message.
_GEM_ServiceStatus	GEM Service Status	_sGEM_SERVICE_STATUS	Gives the GEM Service status. Refer to P. A-212 for details.

\*1. This variable changes to TRUE when a user-defined primary message (Sx,Fy) is received from the host. It will change to FALSE when execution of the instruction is completed normally.

\*2. If the W bit of the primary message is set to OFF on the SECS/GEM Configurator, this variable changes to FALSE after sending the primary message is completed.

## Related Error Codes

Error code	Name	Description
16#041D	Exceeded Simultaneous Instruction Executed Resources	The number of simultaneously executed GEM instructions exceeded the limit.
16#3822	Set to Disable	A message number that was disabled on the SECS/GEM Configurator was specified in <i>MsgNo</i> .
16#3827	Undefined Message Number	A value that was not defined in user-defined messages on the SECS/GEM Configurator was specified in <i>MsgNo</i> .
16#3838	Illegal SECS Message	The received SECS message (Sx,Fy) was set to a message that was not (Sx,Fy+1).
16#3810	GEM Service Status in Initializing	The instruction was executed when the GEM Service status was Initializing.
16#3811	GEM Service Status in EQStarting	The instruction was executed when the GEM Service status was EQStarting.
16#3812	GEM Service Status in EQInitializing	The instruction was executed when the GEM Service status was EQInitializing.
16#3814	GEM Service Status in Stop	The instruction was executed when the GEM Service status was Stop.
16#3815	GEM Service Status in Error	The instruction was executed when the GEM Service status was Error.
16#3816	GEM Service Status in ShuttingDown	The instruction was executed when the GEM Service status was ShuttingDown.
16#3817	GEM Service Status in Shutdown	The instruction was executed when the GEM Service status was Shutdown.

Error code	Name	Description
16#3818	No Message Received	The instruction was executed without receiving a user-defined message from the host.

## Precautions for Correct Use

- Before executing the instruction, confirm that all of the following conditions are met. If the instruction is executed when any of these conditions is not met, an error will occur and *Error* will change to TRUE.
  - a) *\_GEM\_ServiceStatus* must be *EQRun*.
  - b) *\_GEM\_BusyHostUserMsg* must be FALSE.
- In the following cases, the *\_GEM\_BusyHostUserMsg* does not change to TRUE even if a user-defined primary message (Sx,Fy) is received.
  - a) The SECS message (S,F) registered on the SECS/GEM Configurator does not match its items.

## Application Procedure

Use the following procedure for this instruction.

- 1** Detecting the User-defined Message from Host  
 Confirm that *\_GEM\_BusyHostUserMsg* changes from FALSE to TRUE.
- 2** Confirming the Received Data for the User-defined Message  
 Check the received message number that was stored in *\_GEM\_HostUserMsgNo*. Check the user-defined variables for the message number and perform required processing.
- 3** Returning the User-defined Message  
 Specify the message number for which to send a reply in the *MsgNo* input variable and execute the instruction. The user-defined message is sent to the host as the reply.

## Sample Programming

This sample sends the user-defined message with message number 4 as the reply for the user-defined message with message number 3 from the host.

## SECS/GEM Configurator

First, the following user-defined messages are created on the SECS/GEM Configurator.

Message number	S/F	Branch number	Enabled/disabled	Direction	Reply	Abbreviation	Message name	Message structure	Link variable
3		1	Enabled	H → E	Yes	TEST1	Sample Request	<B>	
4		1	Enabled	H ← E	---	TEST2	Sample Data	<B>	

Next, enter the programming on the Sysmac Studio.

## LD

Internal Variables	Variable	Data type	Initial value	Comment
	varMsgNo	UINT	0	Message number
	RespHostUserMsg_instance	GEM_RespHostUserMsg		Instance of GEM_RespHostUserMsg instruction

External Variables	Variable	Comment
	_GEM_ServiceStatus	GEM Service status
	_GEM_BusyHostUserMsg	Host-initiated User-defined Message Transaction Processing Flag
	_GEM_HostUserMsgNo	Host-initiated User-defined Message Number

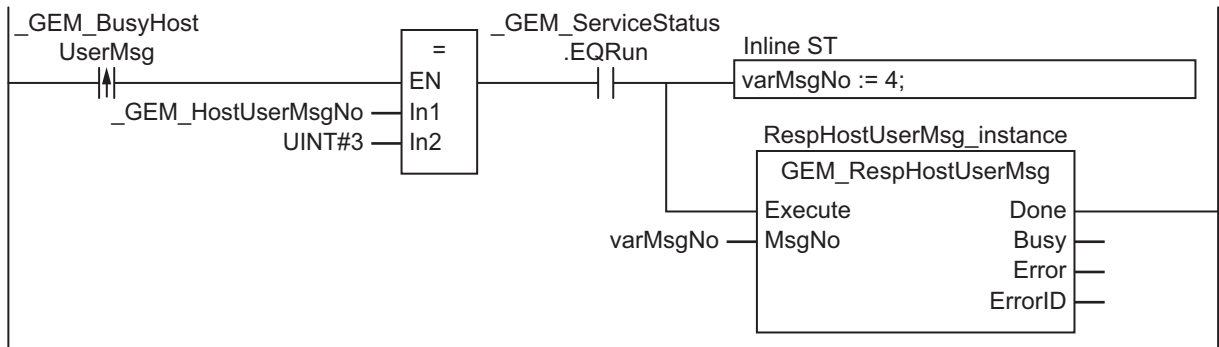

## ST

Internal Variables	Variable	Data type	Initial value	Comment
	RespHostUserMsg_instance	GEM_RespHostUserMsg		Instance of GEM_RespHostUserMsg instruction
	R_TRIG_instance	R_TRIG		Instance of R_TRIG instruction
	Trigger	BOOL	FALSE	Flag for TRUE to FALSE change in _GEM_BusyHostUserMsg
	Stage	INT	0	Program execution status
	varMsgNo	UINT	0	Message number

External Variables	Variable	Comment
	_GEM_ServiceStatus	GEM Service status
	_GEM_BusyHostUserMsg	Host-initiated User-defined Message Transaction Processing Flag
	_GEM_HostUserMsgNo	Host-initiated User-defined Message Number

```

CASE Stage Of
0: // Notification of reception from host
  R_TRIG_instance(_GEM_BusyHostUserMsg, Trigger );
  IF( Trigger = TRUE )THEN
    // Judgement
    IF(_GEM_HostUserMsgNo = 3 ) THEN
      VarMsgNo:= UINT#4;
    END_IF;
  
```

```
        // Initialization
        RespHostUserMsg_instance ( Execute:=FALSE, MsgNo := VarMsgNo );
        Stage:=1;
    END_IF;
1:// Reply to host.
    RespHostUserMsg_instance( Execute:=TRUE, MsgNo := VarMsgNo );
    IF(RespHostUserMsg_instance.Done = TRUE ) THEN
        Stage := 10;
    ELSIF(RespHostUserMsg_instance.Error = TRUE ) THEN
        // Add error processing as required.
        Stage := 10;
    END_IF;
10: // End
    Stage := 0;
END_CASE;
```



## A-1-7 Events That Occur for GEM Instruction Execution

This section provides a table of errors (events) that occur for GEM instructions and detailed information on those errors (events).

### Event Code List

This section provides a table of errors (events) that occur for GEM instructions.

Errors are given as event codes that use the error code as the lower four digits. For descriptions of the error codes, refer to the descriptions of the corresponding event codes. For example, if the error code of the instruction is 16#0400, refer to the description of the event with event code 54010400 hex. The number 16#5401 in the upper four digits is the error that occurs for instruction execution.

Event levels are given in the table as follows:

- Maj: Major fault level
- Prt: Partial fault level
- Min: Minor fault level
- Obs: Observation
- Info: Information

Refer to the *NJ/NX-series Troubleshooting Manual* (Cat. No. W503) for error (event) concepts and for all of the event codes that may occur for an NJ-series Controller.

Event code	Event name	Meaning	Assumed cause	Level					Refer-ence
				Maj	Prt	Min	Obs	Info	
54010400 hex	Input Value Out of Range	An input parameter for an instruction exceeded the valid range for an input variable. Or, division by an integer of 0 occurred in division or remainder calculations.	<ul style="list-style-type: none"> <li>An input parameter for an instruction exceeded the valid range for an input variable. Or, division by an integer of 0 occurred in division or remainder calculations.</li> </ul>				✓		*1
54010419 hex	Incorrect Data Type	A data type that cannot be used for an instruction is specified for an input or in-out variable.	<ul style="list-style-type: none"> <li>A data type that cannot be used for an instruction is specified for an input or in-out variable.</li> </ul>				✓		*1
5401041D hex	Exceeded Simultaneous Instruction Executed Resources	The maximum resources that you can use for the relevant instruction group at the same time was exceeded.	<ul style="list-style-type: none"> <li>More than the maximum number of relevant instructions were executed at the same time.</li> </ul>				✓		*1

Event code	Event name	Meaning	Assumed cause	Level					Reference
				Maj	Prt	Min	Obs	Info	
54013810 hex	GEM Service Status in Initializing	An instruction was executed when the GEM Service status was Initializing.	<ul style="list-style-type: none"> <li>The relevant instruction was executed when the GEM Service status was Initializing.</li> </ul>				✓		P. A-193
54013811 hex	GEM Service Status in EQStarting	An instruction was executed when the GEM Service status was EQStarting.	<ul style="list-style-type: none"> <li>The relevant instruction was executed when the GEM Service status was EQStarting.</li> </ul>				✓		P. A-193
54013812 hex	GEM Service Status in EQInitializing	An instruction was executed when the GEM Service status was EQInitializing.	<ul style="list-style-type: none"> <li>The relevant instruction was executed when the GEM Service status was EQInitializing.</li> </ul>				✓		P. A-194
54013813 hex	GEM Service Status in EQRun	An instruction was executed when the GEM Service status was EQRun.	<ul style="list-style-type: none"> <li>The relevant instruction was executed when the GEM Service status was EQRun.</li> </ul>				✓		P. A-194
54013814 hex	GEM Service Status in Stop	An instruction was executed when the GEM Service status was Stop.	<ul style="list-style-type: none"> <li>The relevant instruction was executed when the GEM Service status was Stop.</li> </ul>				✓		P. A-195
54013815 hex	GEM Service Status in Error	An instruction was executed when the GEM Service status was Error.	<ul style="list-style-type: none"> <li>The relevant instruction was executed when the GEM Service status was Error.</li> </ul>				✓		P. A-195
54013816 hex	GEM Service Status in ShuttingDown	An instruction was executed when the GEM Service status was ShuttingDown.	<ul style="list-style-type: none"> <li>The relevant instruction was executed when the GEM Service status was ShuttingDown.</li> </ul>				✓		P. A-196
54013817 hex	GEM Service Status in Shutdown	An instruction was executed when the GEM Service status was Shutdown.	<ul style="list-style-type: none"> <li>The relevant instruction was executed when the GEM Service status was Shutdown.</li> </ul>				✓		P. A-196
54013818 hex	No Message Received	An instruction was executed without receiving a SECS message from the host.	<ul style="list-style-type: none"> <li>The relevant instruction was executed without receiving the relevant SECS message from the host.</li> </ul>				✓		P. A-197
54013819 hex	Multi-execution of Instructions	Processing of a transaction for a different instance of the same instruction that was executed before this instruction is not completed.	<ul style="list-style-type: none"> <li>This instruction was executed before completing processing for a transaction for a different instance of the same instruction.</li> </ul>				✓		P. A-198

Event code	Event name	Meaning	Assumed cause	Level					Reference
				Maj	Prt	Min	Obs	Info	
5401381A hex	State Transition in Progress	A state transition for a different instance of the same instruction that was executed before this instruction is not completed.	<ul style="list-style-type: none"> <li>This instruction was executed for a different instance of the GEM_ChangeCommState instruction in EnabledNotComm state.</li> <li>This instruction was executed for a different instance of the GEM_ChangeControlState instruction in AttemptOnline state.</li> </ul>				✓		P. A-199
5401381B hex	Insufficient Transaction Resource	The instruction was executed while the number of transactions that can be buffered exceeds the upper limit.	<ul style="list-style-type: none"> <li>The instruction was executed while the number of transactions that can be buffered exceeds the upper limit.</li> </ul>				✓		P. A-200
54013820 hex	Too Many Characters	More characters were specified than the number that was set and the instruction was executed.	<ul style="list-style-type: none"> <li>More characters were specified than the number of characters set with the SECS/GEM Configurator.</li> </ul>				✓		P. A-200
54013821 hex	Invalid Size	An incorrect array or an array with an incorrect number of elements was specified and the instruction was executed.	<ul style="list-style-type: none"> <li>A value was specified that is larger than the maximum table size set with the SECS/GEM Configurator.</li> </ul>				✓		P. A-201
54013822 hex	Set to Disable	The instruction that was set to disable was executed.	<ul style="list-style-type: none"> <li>The instruction executed for a GEM capability was disabled on the SECS/GEM Configurator.</li> </ul>				✓		P. A-201
54013824 hex	Undefined CEID	An undefined CEID was specified and the instruction was executed.	<ul style="list-style-type: none"> <li>A CEID that was not defined in the SECS/GEM Configurator was specified.</li> </ul>				✓		P. A-202
54013825 hex	Undefined ALID	An undefined ALID was specified and the instruction was executed.	<ul style="list-style-type: none"> <li>An ALID that was not defined in the SECS/GEM Configurator was specified.</li> </ul>				✓		P. A-202
54013826 hex	Undefined CCODE	An undefined CCODE was specified and the instruction was executed.	<ul style="list-style-type: none"> <li>A CCODE that was not defined in the SECS/GEM Configurator was specified.</li> </ul>				✓		P. A-203
54013827 hex	Undefined Message Number	An undefined message number was specified and the instruction was executed.	<ul style="list-style-type: none"> <li>A message number that was not defined in the SECS/GEM Configurator was specified.</li> </ul>				✓		P. A-203

Event code	Event name	Meaning	Assumed cause	Level					Reference
				Maj	Prt	Min	Obs	Info	
54013828 hex	HSMS Communications Setting Out of Range	An HSMS communications setting that is out of range was specified and the instruction was executed.	• An HSMS communications setting that is out of range was specified.				✓		P. A-204
54013829 hex	TID Out of Range	A TID that is out of range was specified and the instruction was executed.	• A TID that is out of range was specified.				✓		P. A-204
5401382C hex	Undefined ECID	An undefined ECID was specified and the instruction was executed.	• An ECID that was not defined in the SECS/GEM Configurator was specified.				✓		P. A-205
5401382D hex	Type Mismatch	A value with an incorrect data type was specified and the instruction was executed.	• A different equipment constant data type than the one registered with the SECS/GEM Configurator was specified.				✓		P. A-205
5401382E hex	ECV Out of Range	An out-of-range value was specified for an equipment constant and the instruction was executed.	• A value was specified that is outside the upper and lower limits of the value of the equipment constant that was set on the SECS/GEM Configurator.				✓		P. A-206
5401382F hex	Illegal CPNAME	A CPNAME that is different from the received CPNAME was specified and the instruction was executed.	• A CPNAME was specified that is different from the received CPNAME.				✓		P. A-206
54013830 hex	HACK Out of Range	An HACK that is out of range was specified and the instruction was executed.	• An HACK that is out of range was specified.				✓		P. A-207
54013831 hex	CPACK Out of Range	A CPACK that is out of range was specified and the instruction was executed.	• A CPACK that is out of range was specified.				✓		P. A-207
54013832 hex	CEPACK Out of Range	A CEPACK that is out of range was specified and the instruction was executed.	• A CEPACK that is out of range was specified.				✓		P. A-208
54013833 hex	ACKC7 Out of Range	An ACKC7 that is out of range was specified and the instruction was executed.	• An ACKC7 that is out of range was specified.				✓		P. A-208

Event code	Event name	Meaning	Assumed cause	Level					Refer-ence
				Maj	Prt	Min	Obs	Info	
54013834 hex	ACKC7A Out of Range	An ACKC7A that is out of range was specified and the instruction was executed.	<ul style="list-style-type: none"> <li>An ACKC7A that is out of range was specified.</li> </ul>				✓		P. A-209
54013835 hex	ACKC10 Out of Range	An ACKC10 that is out of range was specified and the instruction was executed.	<ul style="list-style-type: none"> <li>An ACKC10 that is out of range was specified.</li> </ul>				✓		P. A-209
54013836 hex	EAC Out of Range	An EAC that is out of range was specified and the instruction was executed.	<ul style="list-style-type: none"> <li>An EAC that is out of range was specified.</li> </ul>				✓		P. A-210
54013838 hex	Illegal SECS Message	A message number for which an illegal SECS message is set was specified and the instruction was executed.	<ul style="list-style-type: none"> <li>A message number for which a SECS message that does not agree with the instruction specifications was specified.</li> </ul>				✓		P. A-210

\*1. Refer to the *NJ/NX-series Instructions Reference Manual* (Cat. No. W502).

## Event Code Details

This section provides detailed information on errors (events) that occur for GEM instructions. The lower four digits of the event code give the error code for the instruction. For descriptions of the error codes, refer to the descriptions of the corresponding event codes. For example, if the error code of the instruction is 16#0400, refer to the description of the event with event code 54010400 hex.

The items that are used to describe individual errors (events) are described in the following copy of an error table.

<b>Event name</b>	Gives the name of the error.			<b>Event code</b>	Gives the code of the error.	
<b>Meaning</b>	Gives a short description of the error.					
<b>Source</b>	Gives the source of the error.		<b>Source details</b>	Gives details on the source of the error.	<b>Detection timing</b>	Tells when the error is detected.
	<b>Level</b>	Tells the level of influence on control.*1				
<b>Error attributes</b>	<b>User program</b>	Tells what will happen to execution of the user program.*4	<b>Operation</b>	Provides special information on the operation that results from the error.		
<b>Effects</b>	<b>Variable</b>			<b>Data type</b>		<b>Name</b>
	Lists the variable names, data types, and meanings for system-defined variables that provide direct error notification, that are directly affected by the error, or that contain settings that cause the error.					
<b>Cause and correction</b>	<b>Assumed cause</b>		<b>Correction</b>		<b>Prevention</b>	
	Lists the possible causes, corrections, and preventive measures for the error.					
<b>Attached information</b>	This is the attached information that is displayed by the Sysmac Studio or an HMI.*5					
<b>Precautions/Remarks</b>	Provides precautions, restrictions, and supplemental information.					

\*1. One of the following:

- Major fault: Major fault level
- Partial fault: Partial fault level
- Minor fault: Minor fault level
- Observation
- Information

\*2. One of the following:

- Automatic recovery: Normal status is restored automatically when the cause of the error is removed.
- Error reset: Normal status is restored when the error is reset after the cause of the error is removed.
- Cycle the power supply: Normal status is restored when the power supply to the Controller is turned OFF and then back ON after the cause of the error is removed.
- Controller reset: Normal status is restored when the Controller is reset after the cause of the error is removed.
- Depends on cause: The recovery method depends on the cause of the error.

\*3. One of the following:

- System: System event log
- Access: Access event log

\*4. One of the following:

- Continues: Execution of the user program will continue.
- Stops: Execution of the user program stops.
- Starts: Execution of the user program starts.

\*5. Refer to the appendices of the *NJ/NX-series Troubleshooting Manual* (Cat. No. W503) for the applicable range of the HMI Troubleshooter.

<b>Event name</b>	GEM Service Status in Initializing		<b>Event code</b>	54013810 hex	
<b>Meaning</b>	An instruction was executed when the GEM Service status was Initializing.				
<b>Source</b>	PLC Function Module		<b>Source details</b>	Instruction	<b>Detection timing</b> At instruction execution
<b>Error attributes</b>	<b>Level</b>	Observation	<b>Recovery</b>	---	<b>Log category</b> System
<b>Effects</b>	<b>User program</b>	Continues.	<b>Operation</b>	The relevant instruction will end according to specifications.	
<b>System-defined variables</b>	<b>Variable</b>		<b>Data type</b>		<b>Name</b>
	_GEM_ServiceStatus		_sGEM_SERVICE_STATUS		GEM Service Status
<b>Cause and correction</b>	<b>Assumed cause</b>		<b>Correction</b>		<b>Prevention</b>
	The relevant instruction was executed when the GEM Service status was Initializing.		Execute the relevant instruction in a GEM Service status in which the instruction can operate.		Confirm the GEM Service status in the <i>_GEM_ServiceStatus</i> system variable before you execute the instruction.
<b>Attached information</b>	<p>Attached Information 1: Error Location</p> <p>Attached Information 2: Error Location Details (Rung Number). For a program section, the rung number from the start of the section is given. For ST, the line number is given.</p> <p>Attached Information 3: Names of the Instruction and Instruction Instance Where the Error Occurred. If there is more than one possible instruction, information is given on all of them. Nothing is given if the instruction cannot be identified.</p> <p>Attached Information 4: Expansion Error Code (<i>ErrorIDEx</i>)</p>				
<b>Precautions/Remarks</b>	None				

<b>Event name</b>	GEM Service Status in EQStarting		<b>Event code</b>	54013811 hex	
<b>Meaning</b>	An instruction was executed when the GEM Service status was EQStarting.				
<b>Source</b>	PLC Function Module		<b>Source details</b>	Instruction	<b>Detection timing</b> At instruction execution
<b>Error attributes</b>	<b>Level</b>	Observation	<b>Recovery</b>	---	<b>Log category</b> System
<b>Effects</b>	<b>User program</b>	Continues.	<b>Operation</b>	The relevant instruction will end according to specifications.	
<b>System-defined variables</b>	<b>Variable</b>		<b>Data type</b>		<b>Name</b>
	_GEM_ServiceStatus		_sGEM_SERVICE_STATUS		GEM Service Status
<b>Cause and correction</b>	<b>Assumed cause</b>		<b>Correction</b>		<b>Prevention</b>
	The relevant instruction was executed when the GEM Service status was EQStarting.		Execute the relevant instruction in a GEM Service status in which the instruction can operate.		Confirm the GEM Service status in the <i>_GEM_ServiceStatus</i> system variable before you execute the instruction.
<b>Attached information</b>	<p>Attached Information 1: Error Location</p> <p>Attached Information 2: Error Location Details (Rung Number). For a program section, the rung number from the start of the section is given. For ST, the line number is given.</p> <p>Attached Information 3: Names of the Instruction and Instruction Instance Where the Error Occurred. If there is more than one possible instruction, information is given on all of them. Nothing is given if the instruction cannot be identified.</p> <p>Attached Information 4: Expansion Error Code (<i>ErrorIDEx</i>)</p>				
<b>Precautions/Remarks</b>	None				

<b>Event name</b>	GEM Service Status in EQInitializing		<b>Event code</b>	54013812 hex	
<b>Meaning</b>	An instruction was executed when the GEM Service status was EQInitializing.				
<b>Source</b>	PLC Function Module		<b>Source details</b>	Instruction	<b>Detection timing</b> At instruction execution
<b>Error attributes</b>	<b>Level</b>	Observation	<b>Recovery</b>	---	<b>Log category</b> System
<b>Effects</b>	<b>User program</b>	Continues.	<b>Operation</b>	The relevant instruction will end according to specifications.	
<b>System-defined variables</b>	<b>Variable</b>	<b>Data type</b>		<b>Name</b>	
	_GEM_ServiceStatus	_sGEM_SERVICE_STATUS		GEM Service Status	
<b>Cause and correction</b>	<b>Assumed cause</b>		<b>Correction</b>		<b>Prevention</b>
	The relevant instruction was executed when the GEM Service status was EQInitializing.		Execute the relevant instruction in a GEM Service status in which the instruction can operate.		Confirm the GEM Service status in the <i>_GEM_ServiceStatus</i> system variable before you execute the instruction.
<b>Attached information</b>	<p>Attached Information 1: Error Location</p> <p>Attached Information 2: Error Location Details (Rung Number). For a program section, the rung number from the start of the section is given. For ST, the line number is given.</p> <p>Attached Information 3: Names of the Instruction and Instruction Instance Where the Error Occurred. If there is more than one possible instruction, information is given on all of them. Nothing is given if the instruction cannot be identified.</p> <p>Attached Information 4: Expansion Error Code (<i>ErrorIDEx</i>)</p>				
<b>Precautions/Remarks</b>	None				

<b>Event name</b>	GEM Service Status in EQRun		<b>Event code</b>	54013813 hex	
<b>Meaning</b>	An instruction was executed when the GEM Service status was EQRun.				
<b>Source</b>	PLC Function Module		<b>Source details</b>	Instruction	<b>Detection timing</b> At instruction execution
<b>Error attributes</b>	<b>Level</b>	Observation	<b>Recovery</b>	---	<b>Log category</b> System
<b>Effects</b>	<b>User program</b>	Continues.	<b>Operation</b>	The relevant instruction will end according to specifications.	
<b>System-defined variables</b>	<b>Variable</b>	<b>Data type</b>		<b>Name</b>	
	_GEM_ServiceStatus	_sGEM_SERVICE_STATUS		GEM Service Status	
<b>Cause and correction</b>	<b>Assumed cause</b>		<b>Correction</b>		<b>Prevention</b>
	The relevant instruction was executed when the GEM Service status was EQRun.		Execute the relevant instruction in a GEM Service status in which the instruction can operate.		Confirm the GEM Service status in the <i>_GEM_ServiceStatus</i> system variable before you execute the instruction.
<b>Attached information</b>	<p>Attached Information 1: Error Location</p> <p>Attached Information 2: Error Location Details (Rung Number). For a program section, the rung number from the start of the section is given. For ST, the line number is given.</p> <p>Attached Information 3: Names of the Instruction and Instruction Instance Where the Error Occurred. If there is more than one possible instruction, information is given on all of them. Nothing is given if the instruction cannot be identified.</p> <p>Attached Information 4: Expansion Error Code (<i>ErrorIDEx</i>)</p>				
<b>Precautions/Remarks</b>	None				



<b>Event name</b>	GEM Service Status in Stop		<b>Event code</b>	54013814 hex	
<b>Meaning</b>	An instruction was executed when the GEM Service status was Stop.				
<b>Source</b>	PLC Function Module		<b>Source details</b>	Instruction	<b>Detection timing</b> At instruction execution
<b>Error attributes</b>	<b>Level</b>	Observation	<b>Recovery</b>	---	<b>Log category</b> System
<b>Effects</b>	<b>User program</b>	Continues.	<b>Operation</b>	The relevant instruction will end according to specifications.	
<b>System-defined variables</b>	<b>Variable</b>	<b>Data type</b>		<b>Name</b>	
	_GEM_ServiceStatus	_sGEM_SERVICE_STATUS		GEM Service Status	
<b>Cause and correction</b>	<b>Assumed cause</b>		<b>Correction</b>		<b>Prevention</b>
	The relevant instruction was executed when the GEM Service status was Stop.		Execute the relevant instruction in a GEM Service status in which the instruction can operate.		Confirm the GEM Service status in the <i>_GEM_ServiceStatus</i> system variable before you execute the instruction.
<b>Attached information</b>	<p>Attached Information 1: Error Location</p> <p>Attached Information 2: Error Location Details (Rung Number). For a program section, the rung number from the start of the section is given. For ST, the line number is given.</p> <p>Attached Information 3: Names of the Instruction and Instruction Instance Where the Error Occurred. If there is more than one possible instruction, information is given on all of them. Nothing is given if the instruction cannot be identified.</p> <p>Attached Information 4: Expansion Error Code (<i>ErrorIDEx</i>)</p>				
<b>Precautions/Remarks</b>	None				

<b>Event name</b>	GEM Service Status in Error		<b>Event code</b>	54013815 hex	
<b>Meaning</b>	An instruction was executed when the GEM Service status was Error.				
<b>Source</b>	PLC Function Module		<b>Source details</b>	Instruction	<b>Detection timing</b> At instruction execution
<b>Error attributes</b>	<b>Level</b>	Observation	<b>Recovery</b>	---	<b>Log category</b> System
<b>Effects</b>	<b>User program</b>	Continues.	<b>Operation</b>	The relevant instruction will end according to specifications.	
<b>System-defined variables</b>	<b>Variable</b>	<b>Data type</b>		<b>Name</b>	
	_GEM_ServiceStatus	_sGEM_SERVICE_STATUS		GEM Service Status	
<b>Cause and correction</b>	<b>Assumed cause</b>		<b>Correction</b>		<b>Prevention</b>
	The relevant instruction was executed when the GEM Service status was Error.		Execute the relevant instruction in a GEM Service status in which the instruction can operate.		Confirm the GEM Service status in the <i>_GEM_ServiceStatus</i> system variable before you execute the instruction.
<b>Attached information</b>	<p>Attached Information 1: Error Location</p> <p>Attached Information 2: Error Location Details (Rung Number). For a program section, the rung number from the start of the section is given. For ST, the line number is given.</p> <p>Attached Information 3: Names of the Instruction and Instruction Instance Where the Error Occurred. If there is more than one possible instruction, information is given on all of them. Nothing is given if the instruction cannot be identified.</p> <p>Attached Information 4: Expansion Error Code (<i>ErrorIDEx</i>)</p>				
<b>Precautions/Remarks</b>	None				

<b>Event name</b>	GEM Service Status in ShuttingDown		<b>Event code</b>	54013816 hex	
<b>Meaning</b>	An instruction was executed when the GEM Service status was ShuttingDown.				
<b>Source</b>	PLC Function Module		<b>Source details</b>	Instruction	<b>Detection timing</b> At instruction execution
<b>Error attributes</b>	<b>Level</b>	Observation	<b>Recovery</b>	---	<b>Log category</b> System
<b>Effects</b>	<b>User program</b>	Continues.	<b>Operation</b>	The relevant instruction will end according to specifications.	
<b>Sys-tem-defined variables</b>	<b>Variable</b>	<b>Data type</b>		<b>Name</b>	
	_GEM_ServiceStatus	_sGEM_SERVICE_STATUS		GEM Service Status	
<b>Cause and correction</b>	<b>Assumed cause</b>		<b>Correction</b>		<b>Prevention</b>
	The relevant instruction was executed when the GEM Service status was ShuttingDown.		Execute the relevant instruction in a GEM Service status in which the instruction can operate.		Confirm the GEM Service status in the <i>_GEM_ServiceStatus</i> system variable before you execute the instruction.
<b>Attached information</b>	<p>Attached Information 1: Error Location</p> <p>Attached Information 2: Error Location Details (Rung Number). For a program section, the rung number from the start of the section is given. For ST, the line number is given.</p> <p>Attached Information 3: Names of the Instruction and Instruction Instance Where the Error Occurred. If there is more than one possible instruction, information is given on all of them. Nothing is given if the instruction cannot be identified.</p> <p>Attached Information 4: Expansion Error Code (<i>ErrorIDEx</i>)</p>				
<b>Precautions/Remarks</b>	None				

<b>Event name</b>	GEM Service Status in Shutdown		<b>Event code</b>	54013817 hex	
<b>Meaning</b>	An instruction was executed when the GEM Service status was Shutdown.				
<b>Source</b>	PLC Function Module		<b>Source details</b>	Instruction	<b>Detection timing</b> At instruction execution
<b>Error attributes</b>	<b>Level</b>	Observation	<b>Recovery</b>	---	<b>Log category</b> System
<b>Effects</b>	<b>User program</b>	Continues.	<b>Operation</b>	The relevant instruction will end according to specifications.	
<b>Sys-tem-defined variables</b>	<b>Variable</b>	<b>Data type</b>		<b>Name</b>	
	_GEM_ServiceStatus	_sGEM_SERVICE_STATUS		GEM Service Status	
<b>Cause and correction</b>	<b>Assumed cause</b>		<b>Correction</b>		<b>Prevention</b>
	The relevant instruction was executed when the GEM Service status was Shutdown.		Execute the relevant instruction in a GEM Service status in which the instruction can operate.		Confirm the GEM Service status in the <i>_GEM_ServiceStatus</i> system variable before you execute the instruction.
<b>Attached information</b>	<p>Attached Information 1: Error Location</p> <p>Attached Information 2: Error Location Details (Rung Number). For a program section, the rung number from the start of the section is given. For ST, the line number is given.</p> <p>Attached Information 3: Names of the Instruction and Instruction Instance Where the Error Occurred. If there is more than one possible instruction, information is given on all of them. Nothing is given if the instruction cannot be identified.</p> <p>Attached Information 4: Expansion Error Code (<i>ErrorIDEx</i>)</p>				
<b>Precautions/Remarks</b>	None				

<b>Event name</b>	No Message Received		<b>Event code</b>	54013818 hex	
<b>Meaning</b>	An instruction was executed without receiving a SECS message from the host.				
<b>Source</b>	PLC Function Module		<b>Source details</b>	Instruction	<b>Detection timing</b> At instruction execution
<b>Error attributes</b>	<b>Level</b>	Observation	<b>Recovery</b>	---	<b>Log category</b> System
<b>Effects</b>	<b>User program</b>	Continues.	<b>Operation</b>	The relevant instruction will end according to specifications.	
<b>System-defined variables</b>	<b>Variable</b>		<b>Data type</b>		<b>Name</b>
	_GEM_BusyHostChangeECV		BOOL		Host-initiated Equipment Constant Change Transaction Processing Flag
	_GEM_BusyHostCmd		BOOL		Host Command Transaction Processing Flag
	_GEM_BusyEnhancedRmtCmd		BOOL		Enhanced Remote Command Transaction Processing Flag
	_GEM_BusyHostFormattedPPUupload		BOOL		Host-initiated Formatted Process Program Upload Transaction Processing Flag
	_GEM_BusyHostPPUupload		BOOL		Host-initiated Process Program Upload Transaction Processing Flag
	_GEM_BusyHostFormattedPPDownload		BOOL		Host-initiated Formatted Process Program Download Transaction Processing Flag
	_GEM_BusyHostPPDownload		BOOL		Host-initiated Process Program Download Transaction Processing Flag
	_GEM_BusyHostTerminalMsgSB		BOOL		Host-initiated Single-block Terminal Message Transaction Processing Flag
	_GEM_BusyHostTerminalMsgMB		BOOL		Host-initiated Multi-block Terminal Message Transaction Processing Flag
_GEM_BusyHostUserMsg		BOOL		Host-initiated User-defined Message Transaction Processing Flag	
<b>Cause and correction</b>	<b>Assumed cause</b>		<b>Correction</b>		<b>Prevention</b>
	The relevant instruction was executed without receiving the relevant SECS message from the host.		Receive the relevant SECS message for the relevant instruction before you execute the instruction.		Check the system-defined variable that indicates processing of a transaction related to the relevant instruction is TRUE before you execute the instruction.
<b>Attached information</b>	<p>Attached Information 1: Error Location</p> <p>Attached Information 2: Error Location Details (Rung Number). For a program section, the rung number from the start of the section is given. For ST, the line number is given.</p> <p>Attached Information 3: Names of the Instruction and Instruction Instance Where the Error Occurred. If there is more than one possible instruction, information is given on all of them. Nothing is given if the instruction cannot be identified.</p> <p>Attached Information 4: Expansion Error Code (<i>ErrorIDEx</i>)</p>				
<b>Precautions/Remarks</b>	None				

<b>Event name</b>	Multi-execution of Instructions		<b>Event code</b>	54013819 hex	
<b>Meaning</b>	Processing of a transaction for a different instance of the same instruction that was executed before this instruction, is not completed.				
<b>Source</b>	PLC Function Module		<b>Source details</b>	Instruction	<b>Detection timing</b> At instruction execution
<b>Error attributes</b>	<b>Level</b>	Observation	<b>Recovery</b>	---	<b>Log category</b> System
<b>Effects</b>	<b>User program</b>	Continues.	<b>Operation</b>	The relevant instruction will end according to specifications.	
<b>System-defined variables</b>	<b>Variable</b>		<b>Data type</b>		<b>Name</b>
	_GEM_BusyEquipFormattedP-PUupload		BOOL		Equipment-initiated Formatted Process Program Upload Transaction Processing Flag
	_GEM_BusyEquipPPUupload		BOOL		Equipment-initiated Process Program Upload Transaction Processing Flag
	_GEM_BusyEquipFormattedP-PDownload		BOOL		Equipment-initiated Formatted Process Program Download Transaction Processing Flag
	_GEM_BusyEquipPPDownload		BOOL		Equipment-initiated Process Program Download Transaction Processing Flag
	_GEM_BusyEquipTerminalMsg		BOOL		Equipment-initiated Terminal Message Transaction Processing Flag
	_GEM_BusyEquipChangeTime		BOOL		Equipment-initiated Time Change Transaction Processing Flag
<b>Cause and correction</b>	<b>Assumed cause</b>		<b>Correction</b>		<b>Prevention</b>
	This instruction was executed before completing processing for a transaction for a different instance of the same instruction.		Correct the program to confirm completion of the previous transaction processing before you execute the next instruction instance.		Execute only one of this instruction in the project. Also, manage transaction processing status and write the user program to perform exclusive control of instruction execution.
<b>Attached information</b>	<p>Attached Information 1: Error Location</p> <p>Attached Information 2: Error Location Details (Rung Number). For a program section, the rung number from the start of the section is given. For ST, the line number is given.</p> <p>Attached Information 3: Names of the Instruction and Instruction Instance Where the Error Occurred. If there is more than one possible instruction, information is given on all of them. Nothing is given if the instruction cannot be identified.</p> <p>Attached Information 4: Expansion Error Code (<i>ErrorIDEx</i>)</p>				
<b>Precautions/Remarks</b>	None				

<b>Event name</b>	State Transition in Progress		<b>Event code</b>	5401381A hex	
<b>Meaning</b>	A state transition for a different instance of the same instruction that was executed before this instruction is not completed.				
<b>Source</b>	PLC Function Module		<b>Source details</b>	Instruction	<b>Detection timing</b> At instruction execution
<b>Error attributes</b>	<b>Level</b>	Observation	<b>Recovery</b>	---	<b>Log category</b> System
<b>Effects</b>	<b>User program</b>	Continues.	<b>Operation</b>	The relevant instruction will end according to specifications.	
<b>Sys-tem-defined variables</b>	<b>Variable</b>		<b>Data type</b>		<b>Name</b>
	_GEM_CommunicationsState		_sGEM_COMM_STATE		Communications State
		_GEM_ControlState		_sGEM_CONTROL_STATE Control State	
<b>Cause and correction</b>	<b>Assumed cause</b>		<b>Correction</b>		<b>Prevention</b>
	This instruction was executed for a different instance of the GEM_ChangeCommState instruction in EnabledNotComm state.		Confirm that the communications state is not EnabledNotComm before you execute the instruction. Or, if the communications state is EnabledNotComm, confirm that a reply timeout has occurred before you execute the instruction.		Check the <i>_GEM_CommunicationsState</i> system-defined variable before you execute the instruction.
		This instruction was executed for a different instance of the GEM_ChangeControlState instruction in AttemptOnline state.		Confirm that the control state is not AttemptOnline before you execute the instruction. Or, if the control state is AttemptOnline, confirm that a reply timeout has occurred before you execute the instruction.	
<b>Attached information</b>	<p>Attached Information 1: Error Location</p> <p>Attached Information 2: Error Location Details (Rung Number). For a program section, the rung number from the start of the section is given. For ST, the line number is given.</p> <p>Attached Information 3: Names of the Instruction and Instruction Instance Where the Error Occurred. If there is more than one possible instruction, information is given on all of them. Nothing is given if the instruction cannot be identified.</p> <p>Attached Information 4: Expansion Error Code (<i>ErrorIDEx</i>)</p>				
<b>Precautions/Remarks</b>	None				

<b>Event name</b>	Insufficient Transaction Resource		<b>Event code</b>	5401 381B hex	
<b>Meaning</b>	The instruction was executed while the number of transactions that can be buffered exceeds the upper limit.				
<b>Source</b>	PLC Function Module		<b>Source details</b>	Instruction	<b>Detection timing</b> At instruction execution
<b>Error attributes</b>	<b>Level</b>	Observation	<b>Recovery</b>	---	<b>Log category</b> System
<b>Effects</b>	<b>User program</b>	Continues.	<b>Operation</b>	The relevant instruction will end according to specifications.	
<b>Sys-tem-defined variables</b>	<b>Variable</b>		<b>Data type</b>		<b>Name</b>
	_GEM_EquipMsgBuf		USINT		Buffer Size of Equipment Initiated Message
<b>Cause and correction</b>	<b>Assumed cause</b>		<b>Correction</b>		<b>Prevention</b>
	The instruction was executed while the number of transactions that can be buffered exceeds the upper limit.		Execute the instruction again.		Before you execute the instruction, confirm the value of <i>_GEM_EquipMsgBuf</i> system-defined variable is not over the upper limit.
<b>Attached information</b>	<p>Attached Information 1: Error Location</p> <p>Attached Information 2: Error Location Details (Rung Number), For a program section, the rung number from the start of the section is given, For ST, the line number is given.</p> <p>Attached Information 3: Names of the Instruction and Instruction Instance Where the Error Occurred. If there is more than one possible instruction, information is given on all of them. Nothing is given if the instruction cannot be identified.</p> <p>Attached Information 4: Expansion Error Code (<i>ErrorIDEx</i>)</p>				
<b>Precautions/Remarks</b>	None				

<b>Event name</b>	Too Many Characters		<b>Event code</b>	5401 3820 hex	
<b>Meaning</b>	More characters were specified than the number that was set and the instruction was executed.				
<b>Source</b>	PLC Function Module		<b>Source details</b>	Instruction	<b>Detection timing</b> At instruction execution
<b>Error attributes</b>	<b>Level</b>	Observation	<b>Recovery</b>	---	<b>Log category</b> System
<b>Effects</b>	<b>User program</b>	Continues.	<b>Operation</b>	The relevant instruction will end according to specifications.	
<b>Sys-tem-defined variables</b>	<b>Variable</b>		<b>Data type</b>		<b>Name</b>
	None		---		---
<b>Cause and correction</b>	<b>Assumed cause</b>		<b>Correction</b>		<b>Prevention</b>
	More characters were specified than the number of characters set with the SECS/GEM Configurator.		Check the information set with the SECS/GEM Configurator and correct the user program.		None
<b>Attached information</b>	<p>Attached Information 1: Error Location</p> <p>Attached Information 2: Error Location Details (Rung Number). For a program section, the rung number from the start of the section is given. For ST, the line number is given.</p> <p>Attached Information 3: Names of the Instruction and Instruction Instance Where the Error Occurred. If there is more than one possible instruction, information is given on all of them. Nothing is given if the instruction cannot be identified.</p> <p>Attached Information 4: Expansion Error Code (<i>ErrorIDEx</i>)</p>				
<b>Precautions/Remarks</b>	None				

<b>Event name</b>	Invalid Size		<b>Event code</b>	54013821 hex		
<b>Meaning</b>	An incorrect array or an array with an incorrect number of elements was specified and the instruction was executed.					
<b>Source</b>	PLC Function Module		<b>Source details</b>	Instruction	<b>Detection timing</b>	At instruction execution
<b>Error attributes</b>	<b>Level</b>	Observation	<b>Recovery</b>	---	<b>Log category</b>	System
<b>Effects</b>	<b>User program</b>	Continues.	<b>Operation</b>	The relevant instruction will end according to specifications.		
<b>System-defined variables</b>	<b>Variable</b>	<b>Data type</b>		<b>Name</b>		
	None	---		---		
<b>Cause and correction</b>	<b>Assumed cause</b>		<b>Correction</b>		<b>Prevention</b>	
	A value was specified that is larger than the maximum table size set with the SECS/GEM Configurator.		Check the information set with the SECS/GEM Configurator and correct the user program.		None	
<b>Attached information</b>	<p>Attached Information 1: Error Location</p> <p>Attached Information 2: Error Location Details (Rung Number). For a program section, the rung number from the start of the section is given. For ST, the line number is given.</p> <p>Attached Information 3: Names of the Instruction and Instruction Instance Where the Error Occurred. If there is more than one possible instruction, information is given on all of them. Nothing is given if the instruction cannot be identified.</p> <p>Attached Information 4: Expansion Error Code (<i>ErrorIDEx</i>)</p>					
<b>Precautions/Remarks</b>	None					

<b>Event name</b>	Set to Disable		<b>Event code</b>	54013822 hex		
<b>Meaning</b>	The instruction that was set to disable was executed.					
<b>Source</b>	PLC Function Module		<b>Source details</b>	Instruction	<b>Detection timing</b>	At instruction execution
<b>Error attributes</b>	<b>Level</b>	Observation	<b>Recovery</b>	---	<b>Log category</b>	System
<b>Effects</b>	<b>User program</b>	Continues.	<b>Operation</b>	The relevant instruction will end according to specifications.		
<b>System-defined variables</b>	<b>Variable</b>	<b>Data type</b>		<b>Name</b>		
	None	---		---		
<b>Cause and correction</b>	<b>Assumed cause</b>		<b>Correction</b>		<b>Prevention</b>	
	The instruction executed for a GEM capability was disabled on the SECS/GEM Configurator.		Check the information set with the SECS/GEM Configurator and correct the user program.		None	
<b>Attached information</b>	<p>Attached Information 1: Error Location</p> <p>Attached Information 2: Error Location Details (Rung Number), For a program section, the rung number from the start of the section is given, For ST, the line number is given.</p> <p>Attached Information 3: Names of the Instruction and Instruction Instance Where the Error Occurred. If there is more than one possible instruction, information is given on all of them. Nothing is given if the instruction cannot be identified.</p> <p>Attached Information 4: Expansion Error Code (<i>ErrorIDEx</i>)</p>					
<b>Precautions/Remarks</b>	None					

<b>Event name</b>	Undefined CEID		<b>Event code</b>	54013824 hex		
<b>Meaning</b>	An undefined CEID was specified and the instruction was executed.					
<b>Source</b>	PLC Function Module		<b>Source details</b>	Instruction	<b>Detection timing</b>	At instruction execution
<b>Error attributes</b>	<b>Level</b>	Observation	<b>Recovery</b>	---	<b>Log category</b>	System
<b>Effects</b>	<b>User program</b>	Continues.	<b>Operation</b>	The relevant instruction will end according to specifications.		
<b>System-defined variables</b>	<b>Variable</b>		<b>Data type</b>		<b>Name</b>	
	None		---		---	
<b>Cause and correction</b>	<b>Assumed cause</b>		<b>Correction</b>		<b>Prevention</b>	
	A CEID that was not defined in the SECS/GEM Configurator was specified.		Check the information set with the SECS/GEM Configurator and correct the user program.		None	
<b>Attached information</b>	<p>Attached Information 1: Error Location</p> <p>Attached Information 2: Error Location Details (Rung Number). For a program section, the rung number from the start of the section is given. For ST, the line number is given.</p> <p>Attached Information 3: Names of the Instruction and Instruction Instance Where the Error Occurred. If there is more than one possible instruction, information is given on all of them. Nothing is given if the instruction cannot be identified.</p> <p>Attached Information 4: Expansion Error Code (<i>ErrorIDEx</i>)</p>					
<b>Precautions/Remarks</b>	None					

<b>Event name</b>	Undefined ALID		<b>Event code</b>	54013825 hex		
<b>Meaning</b>	An undefined ALID was specified and the instruction was executed.					
<b>Source</b>	PLC Function Module		<b>Source details</b>	Instruction	<b>Detection timing</b>	At instruction execution
<b>Error attributes</b>	<b>Level</b>	Observation	<b>Recovery</b>	---	<b>Log category</b>	System
<b>Effects</b>	<b>User program</b>	Continues.	<b>Operation</b>	The relevant instruction will end according to specifications.		
<b>System-defined variables</b>	<b>Variable</b>		<b>Data type</b>		<b>Name</b>	
	None		---		---	
<b>Cause and correction</b>	<b>Assumed cause</b>		<b>Correction</b>		<b>Prevention</b>	
	An ALID that was not defined in the SECS/GEM Configurator was specified.		Check the information set with the SECS/GEM Configurator and correct the user program.		None	
<b>Attached information</b>	<p>Attached Information 1: Error Location</p> <p>Attached Information 2: Error Location Details (Rung Number). For a program section, the rung number from the start of the section is given. For ST, the line number is given.</p> <p>Attached Information 3: Names of the Instruction and Instruction Instance Where the Error Occurred. If there is more than one possible instruction, information is given on all of them. Nothing is given if the instruction cannot be identified.</p> <p>Attached Information 4: Expansion Error Code (<i>ErrorIDEx</i>)</p>					
<b>Precautions/Remarks</b>	None					



<b>Event name</b>	Undefined CCODE		<b>Event code</b>	54013826 hex	
<b>Meaning</b>	An undefined CCODE was specified and the instruction was executed.				
<b>Source</b>	PLC Function Module		<b>Source details</b>	Instruction	<b>Detection timing</b> At instruction execution
<b>Error attributes</b>	<b>Level</b>	Observation	<b>Recovery</b>	---	<b>Log category</b> System
<b>Effects</b>	<b>User program</b>	Continues.	<b>Operation</b>	The relevant instruction will end according to specifications.	
<b>System-defined variables</b>	<b>Variable</b>	<b>Data type</b>		<b>Name</b>	
	None	---		---	
<b>Cause and correction</b>	<b>Assumed cause</b>		<b>Correction</b>		<b>Prevention</b>
	A CCODE that was not defined in the SECS/GEM Configurator was specified.		Check the information set with the SECS/GEM Configurator and correct the user program.		None
<b>Attached information</b>	<p>Attached Information 1: Error Location</p> <p>Attached Information 2: Error Location Details (Rung Number). For a program section, the rung number from the start of the section is given. For ST, the line number is given.</p> <p>Attached Information 3: Names of the Instruction and Instruction Instance Where the Error Occurred. If there is more than one possible instruction, information is given on all of them. Nothing is given if the instruction cannot be identified.</p> <p>Attached Information 4: Expansion Error Code (<i>ErrorIDEx</i>)</p>				
<b>Precautions/Remarks</b>	None				

<b>Event name</b>	Undefined Message Number		<b>Event code</b>	54013827 hex	
<b>Meaning</b>	An undefined message number was specified and the instruction was executed.				
<b>Source</b>	PLC Function Module		<b>Source details</b>	Instruction	<b>Detection timing</b> At instruction execution
<b>Error attributes</b>	<b>Level</b>	Observation	<b>Recovery</b>	---	<b>Log category</b> System
<b>Effects</b>	<b>User program</b>	Continues.	<b>Operation</b>	The relevant instruction will end according to specifications.	
<b>System-defined variables</b>	<b>Variable</b>	<b>Data type</b>		<b>Name</b>	
	None	---		---	
<b>Cause and correction</b>	<b>Assumed cause</b>		<b>Correction</b>		<b>Prevention</b>
	A message number that was not defined in the SECS/GEM Configurator was specified.		Check the information set with the SECS/GEM Configurator and correct the user program.		None
<b>Attached information</b>	<p>Attached Information 1: Error Location</p> <p>Attached Information 2: Error Location Details (Rung Number). For a program section, the rung number from the start of the section is given. For ST, the line number is given.</p> <p>Attached Information 3: Names of the Instruction and Instruction Instance Where the Error Occurred. If there is more than one possible instruction, information is given on all of them. Nothing is given if the instruction cannot be identified.</p> <p>Attached Information 4: Expansion Error Code (<i>ErrorIDEx</i>)</p>				
<b>Precautions/Remarks</b>	None				

<b>Event name</b>	HSMS Communications Setting Out of Range		<b>Event code</b>	5401 3828 hex	
<b>Meaning</b>	An HSMS communications setting that is out of range was specified and the instruction was executed.				
<b>Source</b>	PLC Function Module		<b>Source details</b>	Instruction	<b>Detection timing</b> At instruction execution
<b>Error attributes</b>	<b>Level</b>	Observation	<b>Recovery</b>	---	<b>Log category</b> System
<b>Effects</b>	<b>User program</b>	Continues.	<b>Operation</b>	The relevant instruction will end according to specifications.	
<b>System-defined variables</b>	<b>Variable</b>		<b>Data type</b>		<b>Name</b>
	None		---		---
<b>Cause and correction</b>	<b>Assumed cause</b>		<b>Correction</b>		<b>Prevention</b>
	An HSMS communications setting that is out of range was specified.		Check the valid range defined for the GEM Services and correct the user program.		None
<b>Attached information</b>	<p>Attached Information 1: Error Location</p> <p>Attached Information 2: Error Location Details (Rung Number). For a program section, the rung number from the start of the section is given. For ST, the line number is given.</p> <p>Attached Information 3: Names of the Instruction and Instruction Instance Where the Error Occurred. If there is more than one possible instruction, information is given on all of them. Nothing is given if the instruction cannot be identified.</p> <p>Attached Information 4: Expansion Error Code (<i>ErrorIDEx</i>)</p>				
<b>Precautions/Remarks</b>	None				

<b>Event name</b>	TID Out of Range		<b>Event code</b>	5401 3829 hex	
<b>Meaning</b>	A TID that is out of range was specified and the instruction was executed.				
<b>Source</b>	PLC Function Module		<b>Source details</b>	Instruction	<b>Detection timing</b> At instruction execution
<b>Error attributes</b>	<b>Level</b>	Observation	<b>Recovery</b>	---	<b>Log category</b> System
<b>Effects</b>	<b>User program</b>	Continues.	<b>Operation</b>	The relevant instruction will end according to specifications.	
<b>System-defined variables</b>	<b>Variable</b>		<b>Data type</b>		<b>Name</b>
	None		---		---
<b>Cause and correction</b>	<b>Assumed cause</b>		<b>Correction</b>		<b>Prevention</b>
	A TID that is out of range was specified.		Check the valid range defined for the GEM Services and correct the user program.		None
<b>Attached information</b>	<p>Attached Information 1: Error Location</p> <p>Attached Information 2: Error Location Details (Rung Number). For a program section, the rung number from the start of the section is given. For ST, the line number is given.</p> <p>Attached Information 3: Names of the Instruction and Instruction Instance Where the Error Occurred. If there is more than one possible instruction, information is given on all of them. Nothing is given if the instruction cannot be identified.</p> <p>Attached Information 4: Expansion Error Code (<i>ErrorIDEx</i>)</p>				
<b>Precautions/Remarks</b>	None				

<b>Event name</b>	Undefined ECID		<b>Event code</b>	5401382C hex	
<b>Meaning</b>	An undefined ECID was specified and the instruction was executed.				
<b>Source</b>	PLC Function Module		<b>Source details</b>	Instruction	<b>Detection timing</b> At instruction execution
<b>Error attributes</b>	<b>Level</b>	Observation	<b>Recovery</b>	---	<b>Log category</b> System
<b>Effects</b>	<b>User program</b>	Continues.	<b>Operation</b>	The relevant instruction will end according to specifications.	
<b>System-defined variables</b>	<b>Variable</b>	<b>Data type</b>		<b>Name</b>	
	None	---		---	
<b>Cause and correction</b>	<b>Assumed cause</b>		<b>Correction</b>		<b>Prevention</b>
	An ECID that was not defined in the SECS/GEM Configurator was specified.		Check the information set with the SECS/GEM Configurator and correct the user program.		None
<b>Attached information</b>	<p>Attached Information 1: Error Location</p> <p>Attached Information 2: Error Location Details (Rung Number). For a program section, the rung number from the start of the section is given. For ST, the line number is given.</p> <p>Attached Information 3: Names of the Instruction and Instruction Instance Where the Error Occurred. If there is more than one possible instruction, information is given on all of them. Nothing is given if the instruction cannot be identified.</p> <p>Attached Information 4: Expansion Error Code (<i>ErrorIDEx</i>)</p>				
<b>Precautions/Remarks</b>	None				

<b>Event name</b>	Type Mismatch		<b>Event code</b>	5401382D hex	
<b>Meaning</b>	A value with an incorrect data type was specified and the instruction was executed.				
<b>Source</b>	PLC Function Module		<b>Source details</b>	Instruction	<b>Detection timing</b> At instruction execution
<b>Error attributes</b>	<b>Level</b>	Observation	<b>Recovery</b>	---	<b>Log category</b> System
<b>Effects</b>	<b>User program</b>	Continues.	<b>Operation</b>	The relevant instruction will end according to specifications.	
<b>System-defined variables</b>	<b>Variable</b>	<b>Data type</b>		<b>Name</b>	
	None	---		---	
<b>Cause and correction</b>	<b>Assumed cause</b>		<b>Correction</b>		<b>Prevention</b>
	A different equipment constant data type than the one registered with the SECS/GEM Configurator was specified.		Check the information set with the SECS/GEM Configurator and correct the user program.		None
<b>Attached information</b>	<p>Attached Information 1: Error Location</p> <p>Attached Information 2: Error Location Details (Rung Number). For a program section, the rung number from the start of the section is given. For ST, the line number is given.</p> <p>Attached Information 3: Names of the Instruction and Instruction Instance Where the Error Occurred. If there is more than one possible instruction, information is given on all of them. Nothing is given if the instruction cannot be identified.</p> <p>Attached Information 4: Expansion Error Code (<i>ErrorIDEx</i>)</p>				
<b>Precautions/Remarks</b>	None				

<b>Event name</b>	Value of Equipment Constant Out of Range		<b>Event code</b>	5401382E hex	
<b>Meaning</b>	An out-of-range value was specified for an equipment constant and the instruction was executed.				
<b>Source</b>	PLC Function Module		<b>Source details</b>	Instruction	<b>Detection timing</b> At instruction execution
<b>Error attributes</b>	<b>Level</b>	Observation	<b>Recovery</b>	---	<b>Log category</b> System
<b>Effects</b>	<b>User program</b>	Continues.	<b>Operation</b>	The relevant instruction will end according to specifications.	
<b>System-defined variables</b>	<b>Variable</b>	<b>Data type</b>		<b>Name</b>	
	None	---		---	
<b>Cause and correction</b>	<b>Assumed cause</b>		<b>Correction</b>		<b>Prevention</b>
	A value was specified that is outside the upper and lower limits of the value of the equipment constant that was set on the SECS/GEM Configurator.		Check the information set with the SECS/GEM Configurator and correct the user program.		None
<b>Attached information</b>	Attached Information 1: Error Location Attached Information 2: Error Location Details (Rung Number). For a program section, the rung number from the start of the section is given. For ST, the line number is given. Attached Information 3: Names of the Instruction and Instruction Instance Where the Error Occurred. If there is more than one possible instruction, information is given on all of them. Nothing is given if the instruction cannot be identified. Attached Information 4: Expansion Error Code ( <i>ErrorIDEx</i> )				
<b>Precautions/Remarks</b>	None				

<b>Event name</b>	Illegal CPNAME		<b>Event code</b>	5401382F hex	
<b>Meaning</b>	A CPNAME that is different from the received CPNAME was specified and the instruction was executed.				
<b>Source</b>	PLC Function Module		<b>Source details</b>	Instruction	<b>Detection timing</b> At instruction execution
<b>Error attributes</b>	<b>Level</b>	Observation	<b>Recovery</b>	---	<b>Log category</b> System
<b>Effects</b>	<b>User program</b>	Continues.	<b>Operation</b>	The relevant instruction will end according to specifications.	
<b>System-defined variables</b>	<b>Variable</b>	<b>Data type</b>		<b>Name</b>	
	None	---		---	
<b>Cause and correction</b>	<b>Assumed cause</b>		<b>Correction</b>		<b>Prevention</b>
	A CPNAME was specified that is different from the received CPNAME.		Correct the user program so that the received CPNAME is stored correctly.		None
<b>Attached information</b>	Attached Information 1: Error Location Attached Information 2: Error Location Details (Rung Number). For a program section, the rung number from the start of the section is given. For ST, the line number is given. Attached Information 3: Names of the Instruction and Instruction Instance Where the Error Occurred. If there is more than one possible instruction, information is given on all of them. Nothing is given if the instruction cannot be identified. Attached Information 4: Expansion Error Code ( <i>ErrorIDEx</i> )				
<b>Precautions/Remarks</b>	None				

<b>Event name</b>	HCKACK Out of Range		<b>Event code</b>	54013830 hex	
<b>Meaning</b>	An HCKACK that is out of range was specified and the instruction was executed.				
<b>Source</b>	PLC Function Module		<b>Source details</b>	Instruction	<b>Detection timing</b> At instruction execution
<b>Error attributes</b>	<b>Level</b>	Observation	<b>Recovery</b>	---	<b>Log category</b> System
<b>Effects</b>	<b>User program</b>	Continues.	<b>Operation</b>	The relevant instruction will end according to specifications.	
<b>System-defined variables</b>	<b>Variable</b>	<b>Data type</b>		<b>Name</b>	
	None	---		---	
<b>Cause and correction</b>	<b>Assumed cause</b>		<b>Correction</b>		<b>Prevention</b>
	A HCKACK that is out of range was specified.		Check the valid range defined in SEMI E5 and correct the user program.		None
<b>Attached information</b>	<p>Attached Information 1: Error Location</p> <p>Attached Information 2: Error Location Details (Rung Number). For a program section, the rung number from the start of the section is given. For ST, the line number is given.</p> <p>Attached Information 3: Names of the Instruction and Instruction Instance Where the Error Occurred. If there is more than one possible instruction, information is given on all of them. Nothing is given if the instruction cannot be identified.</p> <p>Attached Information 4: Expansion Error Code (<i>ErrorIDEx</i>)</p>				
<b>Precautions/Remarks</b>	None				

<b>Event name</b>	CPACK Out of Range		<b>Event code</b>	54013831 hex	
<b>Meaning</b>	An CPACK that is out of range was specified and the instruction was executed.				
<b>Source</b>	PLC Function Module		<b>Source details</b>	Instruction	<b>Detection timing</b> At instruction execution
<b>Error attributes</b>	<b>Level</b>	Observation	<b>Recovery</b>	---	<b>Log category</b> System
<b>Effects</b>	<b>User program</b>	Continues.	<b>Operation</b>	The relevant instruction will end according to specifications.	
<b>System-defined variables</b>	<b>Variable</b>	<b>Data type</b>		<b>Name</b>	
	None	---		---	
<b>Cause and correction</b>	<b>Assumed cause</b>		<b>Correction</b>		<b>Prevention</b>
	A CPACK that is out of range was specified.		Check the valid range defined in SEMI E5 and correct the user program.		None
<b>Attached information</b>	<p>Attached Information 1: Error Location</p> <p>Attached Information 2: Error Location Details (Rung Number). For a program section, the rung number from the start of the section is given. For ST, the line number is given.</p> <p>Attached Information 3: Names of the Instruction and Instruction Instance Where the Error Occurred. If there is more than one possible instruction, information is given on all of them. Nothing is given if the instruction cannot be identified.</p> <p>Attached Information 4: Expansion Error Code (<i>ErrorIDEx</i>)</p>				
<b>Precautions/Remarks</b>	None				

<b>Event name</b>	CEPACK Out of Range		<b>Event code</b>	5401 3832 hex	
<b>Meaning</b>	An CEPACK that is out of range was specified and the instruction was executed.				
<b>Source</b>	PLC Function Module		<b>Source details</b>	Instruction	<b>Detection timing</b> At instruction execution
<b>Error attributes</b>	<b>Level</b>	Observation	<b>Recovery</b>	---	<b>Log category</b> System
<b>Effects</b>	<b>User program</b>	Continues.	<b>Operation</b>	The relevant instruction will end according to specifications.	
<b>System-defined variables</b>	<b>Variable</b>	<b>Data type</b>		<b>Name</b>	
	None	---		---	
<b>Cause and correction</b>	<b>Assumed cause</b>		<b>Correction</b>		<b>Prevention</b>
	A CEPACK that is out of range was specified.		Check the valid range defined in SEMI E5 and correct the user program.		None
<b>Attached information</b>	<p>Attached Information 1: Error Location</p> <p>Attached Information 2: Error Location Details (Rung Number). For a program section, the rung number from the start of the section is given. For ST, the line number is given.</p> <p>Attached Information 3: Names of the Instruction and Instruction Instance Where the Error Occurred. If there is more than one possible instruction, information is given on all of them. Nothing is given if the instruction cannot be identified.</p> <p>Attached Information 4: Expansion Error Code (<i>ErrorIDEx</i>)</p>				
<b>Precautions/Remarks</b>	None				

<b>Event name</b>	ACKC7 Out of Range		<b>Event code</b>	5401 3833 hex	
<b>Meaning</b>	An ACKC7 that is out of range was specified and the instruction was executed.				
<b>Source</b>	PLC Function Module		<b>Source details</b>	Instruction	<b>Detection timing</b> At instruction execution
<b>Error attributes</b>	<b>Level</b>	Observation	<b>Recovery</b>	---	<b>Log category</b> System
<b>Effects</b>	<b>User program</b>	Continues.	<b>Operation</b>	The relevant instruction will end according to specifications.	
<b>System-defined variables</b>	<b>Variable</b>	<b>Data type</b>		<b>Name</b>	
	None	---		---	
<b>Cause and correction</b>	<b>Assumed cause</b>		<b>Correction</b>		<b>Prevention</b>
	An ACKC7 that is out of range was specified.		Check the valid range defined in SEMI E5 and correct the user program.		None
<b>Attached information</b>	<p>Attached Information 1: Error Location</p> <p>Attached Information 2: Error Location Details (Rung Number). For a program section, the rung number from the start of the section is given. For ST, the line number is given.</p> <p>Attached Information 3: Names of the Instruction and Instruction Instance Where the Error Occurred. If there is more than one possible instruction, information is given on all of them. Nothing is given if the instruction cannot be identified.</p> <p>Attached Information 4: Expansion Error Code (<i>ErrorIDEx</i>)</p>				
<b>Precautions/Remarks</b>	None				

<b>Event name</b>	ACKC7A Out of Range		<b>Event code</b>	54013834 hex	
<b>Meaning</b>	An ACKC7A that is out of range was specified and the instruction was executed.				
<b>Source</b>	PLC Function Module		<b>Source details</b>	Instruction	<b>Detection timing</b> At instruction execution
<b>Error attributes</b>	<b>Level</b>	Observation	<b>Recovery</b>	---	<b>Log category</b> System
<b>Effects</b>	<b>User program</b>	Continues.	<b>Operation</b>	The relevant instruction will end according to specifications.	
<b>System-defined variables</b>	<b>Variable</b>	<b>Data type</b>		<b>Name</b>	
	None	---		---	
<b>Cause and correction</b>	<b>Assumed cause</b>		<b>Correction</b>		<b>Prevention</b>
	An ACKC7A that is out of range was specified.		Check the valid range defined in SEMI E5 and correct the user program.		None
<b>Attached information</b>	<p>Attached Information 1: Error Location</p> <p>Attached Information 2: Error Location Details (Rung Number). For a program section, the rung number from the start of the section is given. For ST, the line number is given.</p> <p>Attached Information 3: Names of the Instruction and Instruction Instance Where the Error Occurred. If there is more than one possible instruction, information is given on all of them. Nothing is given if the instruction cannot be identified.</p> <p>Attached Information 4: Expansion Error Code (<i>ErrorIDEx</i>)</p>				
<b>Precautions/Remarks</b>	None				

<b>Event name</b>	ACKC10 Out of Range		<b>Event code</b>	54013835 hex	
<b>Meaning</b>	An ACKC10 that is out of range was specified and the instruction was executed.				
<b>Source</b>	PLC Function Module		<b>Source details</b>	Instruction	<b>Detection timing</b> At instruction execution
<b>Error attributes</b>	<b>Level</b>	Observation	<b>Recovery</b>	---	<b>Log category</b> System
<b>Effects</b>	<b>User program</b>	Continues.	<b>Operation</b>	The relevant instruction will end according to specifications.	
<b>System-defined variables</b>	<b>Variable</b>	<b>Data type</b>		<b>Name</b>	
	None	---		---	
<b>Cause and correction</b>	<b>Assumed cause</b>		<b>Correction</b>		<b>Prevention</b>
	An ACKC10 that is out of range was specified.		Check the valid range defined in SEMI E5 and correct the user program.		None
<b>Attached information</b>	<p>Attached Information 1: Error Location</p> <p>Attached Information 2: Error Location Details (Rung Number). For a program section, the rung number from the start of the section is given. For ST, the line number is given.</p> <p>Attached Information 3: Names of the Instruction and Instruction Instance Where the Error Occurred. If there is more than one possible instruction, information is given on all of them. Nothing is given if the instruction cannot be identified.</p> <p>Attached Information 4: Expansion Error Code (<i>ErrorIDEx</i>)</p>				
<b>Precautions/Remarks</b>	None				

<b>Event name</b>	EAC Out of Range		<b>Event code</b>	5401 3836 hex	
<b>Meaning</b>	An EAC that is out of range was specified and the instruction was executed.				
<b>Source</b>	PLC Function Module		<b>Source details</b>	Instruction	<b>Detection timing</b> At instruction execution
<b>Error attributes</b>	<b>Level</b>	Observation	<b>Recovery</b>	---	<b>Log category</b> System
<b>Effects</b>	<b>User program</b>	Continues.	<b>Operation</b>	The relevant instruction will end according to specifications.	
<b>System-defined variables</b>	<b>Variable</b>		<b>Data type</b>		<b>Name</b>
	None		---		---
<b>Cause and correction</b>	<b>Assumed cause</b>		<b>Correction</b>		<b>Prevention</b>
	An EAC that is out of range was specified.		Check the valid range defined in SEMI E5 and correct the user program.		None
<b>Attached information</b>	<p>Attached Information 1: Error Location</p> <p>Attached Information 2: Error Location Details (Rung Number). For a program section, the rung number from the start of the section is given. For ST, the line number is given.</p> <p>Attached Information 3: Names of the Instruction and Instruction Instance Where the Error Occurred. If there is more than one possible instruction, information is given on all of them. Nothing is given if the instruction cannot be identified.</p> <p>Attached Information 4: Expansion Error Code (<i>ErrorIDEx</i>)</p>				
<b>Precautions/Remarks</b>	None				

<b>Event name</b>	Illegal SECS Message		<b>Event code</b>	5401 3838 hex	
<b>Meaning</b>	A message number for which an illegal SECS message is set was specified and the instruction was executed.				
<b>Source</b>	PLC Function Module		<b>Source details</b>	Instruction	<b>Detection timing</b> At instruction execution
<b>Error attributes</b>	<b>Level</b>	Observation	<b>Recovery</b>	---	<b>Log category</b> System
<b>Effects</b>	<b>User program</b>	Continues.	<b>Operation</b>	The relevant instruction will end according to specifications.	
<b>System-defined variables</b>	<b>Variable</b>		<b>Data type</b>		<b>Name</b>
	None		---		---
<b>Cause and correction</b>	<b>Assumed cause</b>		<b>Correction</b>		<b>Prevention</b>
	A message number for which a SECS message that does not agree with the instruction specifications was specified.		Check the information set with the SECS/GEM Configurator and correct the user program.		None
<b>Attached information</b>	<p>Attached Information 1: Error Location</p> <p>Attached Information 2: Error Location Details (Rung Number). For a program section, the rung number from the start of the section is given. For ST, the line number is given.</p> <p>Attached Information 3: Names of the Instruction and Instruction Instance Where the Error Occurred. If there is more than one possible instruction, information is given on all of them. Nothing is given if the instruction cannot be identified.</p> <p>Attached Information 4: Expansion Error Code (<i>ErrorIDEx</i>)</p>				
<b>Precautions/Remarks</b>	None				



# A-2 System-defined Variables

System-defined variables are assigned specific functions by the system.

They are registered in the global variable table, or the local variable table for each POU, in advance.

The variable names cannot be changed.

You read and write the variables with the user program, with communications from external devices, with the Sysmac Studio, or with an NS/NA-series HMI.

Examples of how to interpret the tables of system-defined variables are given below.

## ● Example for Structure Variables

(a)	(c)	(d)	(e)	(f)	(g)	(h)	(i)	(j)
<b>(b)</b>								
_GEM_EquipInfo	Equipment Information	Gives information on the equipment.	_sGEM_EQUIP_INFO					
MDLN	Equipment Model Type	Gives the model of the equipment.	STRING[21]	Depends on data type.	G	RW	Retained.	Published.
SOFTREV	Software Revision Code	Gives the software revision code.	STRING[21]	Depends on data type.				

## ● Example for Variables That Are Not Structures

(a)	(c)	(d)	(e)	(f)	(g)	(h)	(i)	(j)
_GEM_Default Communications State	Default Communications State	Specifies the communications state to enter when the equipment starts. 0: DISABLE Not 0: ENABLE	USINT	Depends on data type.	G	RW	Retained.	Published.

- (a) Gives the name of the system-defined variable. The name starts with the category name.
- (b) Gives the member names for structure variables only.
- (c) Gives the meaning of the variable.
- (d) Describes the function of the variable.
- (e) Gives the data type of the variable.
- (f) Gives the range of values of the variable.
- (g) G: Global variable, L: Local variable.
- (h) Gives the R/W attribute of the variable. R: Read only, RW: Read/write
- (i) Gives the Retain attribute of the variable. Either "Retained" or "Not retained" is given.
- (j) Gives the Network Publish attribute of the variable. Either "Published" or "Not published" is given.

### A-2-1 GEM Service Version

(a)	(c)	(d)	(e)	(f)	(g)	(h)	(i)	(j)
_GEM_Version	GEM Service Version	Gives the version of the GEM service. Element 0 is the integer part of the version. Element 1 is the fractional part of the version. Example: For GEM service version 1.00, element 0 is 1 and element 1 is 0. Example: For GEM service version 1.10, element 0 is 1 and element 1 is 10.	ARRAY[0..1] OF USINT	0 to 99	G	R	Not retained.	Published.

### A-2-2 Equipment Information

(a)	(c)	(d)	(e)	(f)	(g)	(h)	(i)	(j)									
<table border="1"> <tr> <td>(b)</td> <td></td> <td></td> <td></td> <td></td> <td></td> <td></td> <td></td> <td></td> </tr> </table>	(b)									Equipment Information	Gives information on the equipment.	_sGEM_EQUIP_INFO					
(b)																	
MDLN	Equipment Model Type	Gives the model of the equipment.	STRING[21]	Depends on data type.	G	RW	Retained.	Published.									
SOFTREV	Software Revision Code	Gives the software revision code.	STRING[21]	Depends on data type.													

### A-2-3 GEM Service Status

(a)	(c)	(d)	(e)	(f)	(g)	(h)	(i)	(j)									
<table border="1"> <tr> <td>(b)</td> <td></td> <td></td> <td></td> <td></td> <td></td> <td></td> <td></td> <td></td> </tr> </table>	(b)									GEM Service Status	Gives the GEM Service status.	_sGEM_SERVICE_STATUS					
(b)																	

(a)	(c)	(d)	(e)	(f)	(g)	(h)	(i)	(j)
(b)								
Idle	Idle	TRUE while GEM Services are inactive. *1	BOOL	TRUE or FALSE	G	R	Not retained.	Published.
Initializing	Initializing	TRUE while GEM Service initialization is in progress.	BOOL	TRUE or FALSE				
Run	Run	TRUE while GEM Services are active.	BOOL	TRUE or FALSE				
EQStarting	EQStarting	TRUE while waiting for equipment initialization processing.	BOOL	TRUE or FALSE				
EQInitializing	EQInitializing	TRUE while equipment initialization processing is in progress.	BOOL	TRUE or FALSE				
EQRun	EQRun	TRUE when you can use all GEM Services, including communications with the host.	BOOL	TRUE or FALSE				
Stop	Stop	TRUE while GEM Service activity is stopped.	BOOL	TRUE or FALSE				
Error	Error	TRUE while GEM Services are inactive because of an error.	BOOL	TRUE or FALSE				
ShuttingDown	ShuttingDown	TRUE while shutdown processing is in progress.	BOOL	TRUE or FALSE				
Shutdown	Shutdown	TRUE after shutdown processing is completed.	BOOL	TRUE or FALSE				

\*1. This is a standby state while waiting for the Controller's operating mode to change from PROGRAM to RUN.

## A-2-4 SECS Communications

(a)	(c)	(d)	(e)	(f)	(g)	(h)	(i)	(j)
_GEM_CommLogCnt	SECS Communications Log Count	Gives the number of entries in the log.	UINT	Depends on data type.	G	R	Not retained.	Published.

(a)	(c)	(d)	(e)	(f)	(g)	(h)	(i)	(j)
(b)								
_GEM_CommLog	SECS Communications Log	Gives information on SECS communications log.	ARRAY[0..99] OF _sGEM_COMMLOG					

(a)	(b)	(c)	(d)	(e)	(f)	(g)	(h)	(i)	(j)
LogNo	Log Number	Log Number	Gives the order of the record in the log.	UDINT	Depends on data type.	G	R	Not retained.	Published.
LogDate	Logged Date	Logged Date	Gives the date the record was placed in the log.	DATE_AND_TIME	Depends on data type.				
SndRcv	Send/Receive	Send/Receive	Tells whether the message was sent or received. 1: Sent 2: Received	USINT	1 to 2				
StreamCode	Stream Number	Stream Number	Gives the stream number of the message.	USINT	0 to 127				
FunctionCode	Function Number	Function Number	Gives the function number of the message.	USINT	0 to 255				
MsgPtn	Message Branch Number	Message Branch Number	Gives the branch number of the message.	USINT	0 to 255				
OutType	Message Output Type	Message Output Type	Tells how the message was sent. 0: Normal 1: Spooled	USINT	0 to 1				
Rslt	Communications Result	Communications Result	Gives the result of message communications. 0: Normal 3: T3 timeout 6: T6 timeout 7: T7 timeout 8: T8 timeout 10: Not connected.	USINT	0 to 10				

(a)	(c)	(d)	(e)	(f)	(g)	(h)	(i)	(j)	
_GEM_EquipMsgBuf	Equipment-initiated Message Bufferings	Equipment-initiated Message Bufferings	Gives the number of buffering transactions in the GEM Service message queue for equipment-initiated messages.	USINT	Depends on data type.	G	R	Not retained.	Published.
_GEM_HostMsgBuf	Host-initiated Message Bufferings	Host-initiated Message Bufferings	Gives the number of buffering transactions in the GEM Service message queue for host-initiated messages.	USINT	Depends on data type.	G	R	Not retained.	Published.

### A-2-5 Interlocks

(a)	(c)	(d)	(e)	(f)	(g)	(h)	(i)	(j)
_GEM_Interlock _ControlState	Control State Interlock	Specifies whether to prohibit Request ON-LINE from the host. TRUE: Prohibited. FALSE: Granted.	BOOL	TRUE or FALSE	G	RW	Not retained.	Not published.
_GEM_Interlock _Time	Time Change Interlock	Specifies whether to prohibit time changes from the host. TRUE: Prohibited. FALSE: Granted.	BOOL	TRUE or FALSE				
_GEM_Interlock _HostCmd	Host Command Interlock	Specifies whether to prohibit reception of host commands from the host. TRUE: Prohibited. FALSE: Granted.	BOOL	TRUE or FALSE				
_GEM_Interlock _EnhancedRmtCmd	Enhanced Remote Command Interlock	Specifies whether to prohibit reception of enhanced remote commands from the host. TRUE: Prohibited. FALSE: Granted.	BOOL	TRUE or FALSE				
_GEM_Interlock _PP	Process Program Interlock	Specifies whether to prohibit process program deletion requests and upload/download requests from the host. TRUE: Prohibited. FALSE: Granted.	BOOL	TRUE or FALSE				
_GEM_Interlock _ECV	Equipment Constant Interlock	Specifies whether to prohibit equipment constant changes from the host. TRUE: Prohibited. FALSE: Granted.	BOOL	TRUE or FALSE				

### A-2-6 HSMS Communications

(a)	(c)	(d)	(e)	(f)	(g)	(h)	(i)	(j)
<b>(b)</b>								
_GEM_HSMSState	HSMS Communications State	Gives the HSMS Communications state. (The HSMS Communications states are defined in E37.)	_sGEM_HSMS_STATE		G	R	Not retained.	Published.
Not Connected	NOT CONNECTED	TRUE when TCP/IP is not connected.	BOOL	TRUE or FALSE				
NotSelected	NOT SELECTED	TRUE when attempting to connect TCP/IP.	BOOL	TRUE or FALSE				
Selected	SELECTED	TRUE when an TCP/IP connection is established.	BOOL	TRUE or FALSE				

(a)	(b)	(c)	(d)	(e)	(f)	(g)	(h)	(i)	(j)
_GEM_	HSMS_Error	HSMS Communica- tions Errors	Gives errors detected by the HSMS.	_sGEM_HSMS_ ERROR					
	T5	Connection Separation Timeout Detection Count	Gives the number of times a connection separation timeout has occurred.*1	UINT	Depends on data type.	G	R	Not retained.	Pub- lished.
	T6	Control Timeout Detection Count	Gives the number of times a control trans- action timeout has occurred.*1	UINT	Depends on data type.				
	T7	Connection Idle Timeout Detection Count	Gives the number of times a NOT SELECTED timeout has occurred.*1	UINT	Depends on data type.				
	T8	Network Interchar- acter Timeout Detection Count	Gives the number of times a network inter- character timeout has occurred.*1	UINT	Depends on data type.				

\*1. After the upper limit is reached, counting continues from 1.

(a)	(b)	(c)	(d)	(e)	(f)	(g)	(h)	(i)	(j)
_GEM_	HSMS_Param	HSMS Communica- tions Parameters	Gives the active HSMS communica- tions settings.	_sGEM_HSMS_ PARAM					

(a)	(b)	(c)	(d)	(e)	(f)	(g)	(h)	(i)	(j)
ConnectMode		TCP/IP Connection Mode	Gives the TCP/IP connection mode.	_eGEM_CONNECTION	_GEM_CONNECTION_PASSIVE or _GEM_CONNECTION_ACTIVE	G	R	Not retained.	Published.
PassiveIPSel		IP Address Connection Restriction Flag	Tells whether the IP address for connection is restricted when the TCP/IP connection is PASSIVE. FALSE: No restriction. TRUE: Connection is possible only with the IP address set in <i>IpAdr</i> .	BOOL	TRUE or FALSE				
IpAdr		IP Address	Gives the IP address of the host.	STRING[256]	000.000.000.000 - 255.255.255.255				
PortNo		Port Number	Gives the standby port number for GEM Services when the TCP/IP connection is PASSIVE.	UINT	1 to 65,535				
DeviceID		Device ID	Gives the ID that identifies the HSMS message.	UINT	0 to 32767				
T3		Reply Timeout Time	Gives the maximum time in seconds to wait for a reply during HSMS message communications.	USINT	1 to 120				
T5		Connection Separation Timeout Time	Gives the interval in seconds to resend Select Requests when a selection response is not received to a sent Select Request.	USINT	1 to 240				
T6		Control Timeout Time	Gives the maximum time in seconds to wait for a reply during HSMS message communications.	USINT	1 to 240				
T7		Connection Idle Timeout Time	Gives the maximum time in seconds to wait for a Select Request when the TCP/IP connection is PASSIVE.	USINT	1 to 240				
T8		Network Intercharacter Timeout Time	Gives the time in seconds to monitor for multi-packet sent HSMS messages.	USINT	1 to 120				
ConversationTimeout		Conversation Timeout Time	Gives the maximum time in seconds to wait for a reply after sending a message.	USINT	1 to 240				

## A-2-7 Communications State Model

(a)	(b)	(c)	(d)	(e)	(f)	(g)	(h)	(i)	(j)
_GEM_ Communications State		Communications State	Gives the status of communications with the host. (Based on Communications State Model defined in E30.)	_sGEM_COMM_STATE					
	Disabled	DISABLED	TRUE when communications with the host are inactive.	BOOL	TRUE or FALSE	G	R	Not retained.	Published.
	Enabled NotComm	NOT COMMUNICATING	TRUE while communications with the host are established.	BOOL	TRUE or FALSE				
Enabled Comm	COMMUNICATING	TRUE when communications with the host are active.	BOOL	TRUE or FALSE					

(a)	(c)	(d)	(e)	(f)	(g)	(h)	(i)	(j)
_GEM_Default Communications State	Default Communications State	Specifies the communications state to enter when the equipment starts. 0: DISABLE Not 0: ENABLE	USINT	Depends on data type.	G	RW	Retained.	Published.

(a)	(c)	(d)	(e)	(f)	(g)	(h)	(i)	(j)
_GEM_Establish Communications Timeout	Establish Communications Timeout	Gives the timeout time for establishing communications.	UINT	1 to 256	G	R	Retained.	Published.

## A-2-8 Equipment Processing State

(a)	(c)	(d)	(e)	(f)	(g)	(h)	(i)	(j)
_GEM_PreviousProcessState	Previous Processing State	Specifies the previous process state of the equipment.	USINT	Depends on data type.	G	RW	Not retained.	Published
_GEM_ProcessState	Processing State	Specifies the current process state of the equipment.	USINT	Depends on data type.				

## A-2-9 Control State Model

(a)	(b)	(c)	(d)	(e)	(f)	(g)	(h)	(i)	(j)
_GEM_ControlState		Control State	Gives the control state of the equipment.	_sGEM_CONTROL_STATE					



(a)	(b)	(c)	(d)	(e)	(f)	(g)	(h)	(i)	(j)
	EquipOffline	EQUIPMENT OFF-LINE	TRUE when equipment is OFF-LINE.	BOOL	TRUE or FALSE	G	R	Not retained.	Published.
	HostOffline	HOST OFF-LINE	TRUE when operator requested ON-LINE but the host denied ON-LINE.	BOOL	TRUE or FALSE				
	AttemptOnline	ATTEMPT ON-LINE	TRUE when operator requests ON-LINE from the host.	BOOL	TRUE or FALSE				
	OnlineLocal	ON-LINE/LOCAL	TRUE during ON-LINE/LOCAL.	BOOL	TRUE or FALSE				
	OnlineRemote	ON-LINE/REMOTE	TRUE during ON-LINE/REMOTE.	BOOL	TRUE or FALSE				

(a)	(b)	(c)	(d)	(e)	(f)	(g)	(h)	(i)	(j)
	_GEM_Control StateParam	Control State Parameters	Specifies the default values for the control state.	_sGEM_CONTROL_STATE_PARAM					
	Default Control	Default Control State	Specifies the default state when the system starts. 0: EQUIPMENT OFF-LINE 1: ATTEMPT ON-LINE 2: HOST OFF-LINE 3: ON-LINE	USINT	0 to 3	G	RW	Retained.	Published.
	DefaultOnline-SubState	Default ON-LINE Substate	Specifies the default substate after transition to ON-LINE. 0: REMOTE 1: LOCAL	USINT	0 to 1				
	ChangeOnline-Failed	ON-LINE Failure State	Specifies the default state after failed ON-LINE attempt. 0: EQUIPMENT OFF-LINE 1: HOST OFF-LINE	USINT	0 to 1				

(a)	(c)	(d)	(e)	(f)	(g)	(h)	(i)	(j)	
	_GEM_Operator Command	Operator Command	Specifies operator activity while REMOTE state is active.	USINT	Depends on data type.	G	RW	Not retained.	Not published.

**A-2-10 Remote Control**

(a)	(c)	(d)	(e)	(f)	(g)	(h)	(i)	(j)	
	_GEM_Busy HostCmd	Host Command Transaction Processing Flag	Gives the status of processing a transaction for a host command. TRUE: Processing FALSE: Not processing.	BOOL	TRUE or FALSE	G	R	Not retained.	Not published.

(a)	(c)	(d)	(e)	(f)	(g)	(h)	(i)	(j)
_GEM_BusyEnhancedRmtCmd	Enhanced Remote Command Transaction Processing Flag	Gives the status of processing a transaction for an enhanced remote command. TRUE: Processing FALSE: Not processing.	BOOL	TRUE or FALSE	G	R	Not retained.	Not published.

### A-2-11 Equipment Constants

(a)	(c)	(d)	(e)	(f)	(g)	(h)	(i)	(j)
_GEM_BusyHostChangeECV	Host-initiated Equipment Constant Change Transaction Processing Flag	Gives the status of processing a transaction for a host-initiated equipment constant change. TRUE: Processing FALSE: Not processing.	BOOL	TRUE or FALSE	G	R	Not retained.	Not published.

### A-2-12 Process Program Management

(a)	(c)	(d)	(e)	(f)	(g)	(h)	(i)	(j)
_GEM_BusyHostPPDelete	Host-initiated Process Program Deletion Transaction Processing Flag	Gives the status of processing a transaction for a host-initiated process program deletion. TRUE: Processing FALSE: Not processing.	BOOL	TRUE or FALSE	G	R	Not retained.	Not published.

(a)	(c)	(d)	(e)	(f)	(g)	(h)	(i)	(j)
_GEM_BusyHostFormattedPPUpload	Host-initiated Formatted Process Program Upload Transaction Processing Flag	Gives the status of processing a transaction for a host-initiated formatted process program upload. TRUE: Processing FALSE: Not processing.	BOOL	TRUE or FALSE	G	R	Not retained.	Not published.

(a)	(c)	(d)	(e)	(f)	(g)	(h)	(i)	(j)
_GEM_BusyHostPPUpload	Host-initiated Process Program Upload Transaction Processing Flag	Gives the status of processing a transaction for a host-initiated process program upload. TRUE: Processing FALSE: Not processing.	BOOL	TRUE or FALSE	G	R	Not retained.	Not published.

(a)	(c)	(d)	(e)	(f)	(g)	(h)	(i)	(j)
_GEM_BusyEquipFormattedPPUpload	Equipment-initiated Formatted Process Program Upload Transaction Processing Flag	Gives the status of processing a transaction for an equipment-initiated formatted process program upload. TRUE: Processing FALSE: Not processing.	BOOL	TRUE or FALSE	G	R	Not retained.	Not published.

(a)	(c)	(d)	(e)	(f)	(g)	(h)	(i)	(j)
(b)								
_GEM_EquipFormattedPPUUploadRslt	Equipment-initiated Formatted Process Program Upload Results	Gives the results of processing an equipment-initiated formatted process program upload.	_sGEM_RSLT					
Rslt	Result Flag	TRUE: Normal end FALSE: Error end	BOOL	TRUE or FALSE				
RsltCode	Result Code	Gives a code that tells the result of the upload. 16#0000: Normal 16#0100: Transmission error*1 16#0200: Reception error*1 16#0301 to 16#033F: Same as for PPGNT. 16#0401 to 16#043F: Same as for ACKC7.	WORD	Depends on data type.	G	R	Not retained.	Not published.

\*1. Refer to 5-1-3 Transaction Processing on page 5-6.

(a)	(c)	(d)	(e)	(f)	(g)	(h)	(i)	(j)
_GEM_Busy-EquipPPUUpload	Equipment-initiated Process Program Upload Transaction Processing Flag	Gives the status of processing a transaction for an equipment-initiated process program upload. TRUE: Processing FALSE: Not processing.	BOOL	TRUE or FALSE	G	R	Not retained.	Not published.

(a)	(c)	(d)	(e)	(f)	(g)	(h)	(i)	(j)
(b)								
_GEM_EquipPPUUploadRslt	Equipment-Initiated Process Program Upload Results	Gives the results of processing an equipment-initiated process program upload.	_sGEM_RSLT					
Rslt	Result Flag	TRUE: Normal end FALSE: Error end	BOOL	TRUE or FALSE				
RsltCode	Result Code	Gives a code that tells the result of the upload. 16#0000: Normal 16#0100: Transmission error*1 16#0200: Reception error*1 16#0301 to 16#033F: Same as for PPGNT. 16#0401 to 16#043F: Same as for ACKC7.	WORD	Depends on data type.	G	R	Not retained.	Not published.

\*1. Refer to 5-1-3 Transaction Processing on page 5-6.

(a)	(c)	(d)	(e)	(f)	(g)	(h)	(i)	(j)
_GEM_BusyHost FormattedPP Download	Host-initiated Formatted Process Program Download Transaction Processing Flag	Gives the status of processing a transaction for a host-initiated formatted process program download. TRUE: Processing FALSE: Not processing.	BOOL	TRUE or FALSE	G	R	Not retained.	Not published.
_GEM_BusyHost PPDownload	Host-initiated Process Program Download Transaction Processing Flag	Gives the status of processing a transaction for a host-initiated process program download. TRUE: Processing FALSE: Not processing.	BOOL	TRUE or FALSE	G	R	Not retained.	Not published.

(a)	(c)	(d)	(e)	(f)	(g)	(h)	(i)	(j)
_GEM_BusyEquip-FormattedPPDownload	Equipment-initiated Formatted Process Program Download Transaction Processing Flag	Gives the status of processing a transaction for an equipment-initiated formatted process program download. TRUE: Processing FALSE: Not processing.	BOOL	TRUE or FALSE	G	R	Not retained.	Not published.

(a)	(c)	(d)	(e)	(f)	(g)	(h)	(i)	(j)
_GEM_Equip FormattedPPDownloadRsIt	Equipment-initiated Formatted Process Program Download Results	Gives the results of processing an equipment-initiated formatted process program download.	_sGEM_RSLT					
Rslt	Result Flag	TRUE: Normal end FALSE: Error end	BOOL	TRUE or FALSE				
RsltCode	Result Code	Gives a code that tells the result of the download. 16#0000: Normal 16#0100: Transmission error*1 16#0200: Reception error*1*2*3 16#0300: Rejected by host*4 16#0400: PP data error*5	WORD	0 to 63	G	R	Not retained.	Not published.

\*1. Refer to 5-1-3 Transaction Processing on page 5-6.

\*2. If the maximum SECS message size is exceeded by the received secondary message, the secondary message may have exceeded the *Permissible message LENGTH*.

\*3. If the message structure of the received secondary message is incorrect, the CCODE count may be larger than the set number of registered CCODEs, or the PPARM count may be larger than the maximum PPARM count set for the CCODE.

\*4. This occurs for Formatted Process Program Data (S7,F26) when the list length is 0.

\*5. This occurs if a PPID is incorrect, a CCODE is not registered, or the same CCODE is used twice.

(a)	(c)	(d)	(e)	(f)	(g)	(h)	(i)	(j)
_GEM_Busy-EquipPPDownload	Equipment-initiated Process Program Download Transaction Processing Flag	Gives the status of processing a transaction for an equipment-initiated process program download. TRUE: Processing FALSE: Not processing.	BOOL	TRUE or FALSE	G	R	Not retained.	Not published.

(a)	(c)	(d)	(e)	(f)	(g)	(h)	(i)	(j)
_GEM_EquipPPDownloadRslt	Equipment-Initiated Process Program Download Results	Gives the results of processing an equipment-initiated process program download.	_sGEM_RSLT					
	Rslt	Result Flag	TRUE: Normal end FALSE: Error end	BOOL	TRUE or FALSE			
RsltCode	Result Code	Gives a code that tells the result of the download. 16#0000: Normal 16#0100: Transmission error*1 16#0200: Reception error*1*2*3 16#0300: Rejected by host*4 16#0400: PP data error*5	WORD	Depends on data type.	G	R	Not retained.	Not published.

- \*1. Refer to 5-1-3 *Transaction Processing* on page 5-6.
- \*2. If the maximum SECS message size is exceeded by the received secondary message, the secondary message may have exceeded the *Permissible message LENGTH*.
- \*3. If the message structure of the received message is incorrect, the size of PPBODY may be larger than the PPBODY data size that is set in the item definition.
- \*4. This occurs for Process Program Data (S7,F6) when the list length is 0.
- \*5. This occurs when a PPID is incorrect.

(a)	(c)	(d)	(e)	(f)	(g)	(h)	(i)	(j)
_GEM_PPChangeInfo	Process Program Change Information	Specifies information on operator changes to process programs (i.e., creating, editing, and deleting).	_sGEM_PP_CHANGE					
	PPChangeName	Process Program ID	Specifies the process program that was created, edited, or deleted by the operator.	STRING[121]	Depends on data type.			
	PPChangeStatus	Status	Specifies the action performed for the process program. 1: Created. 2: Edited. 3: Deleted. 4 to 63: Reserved	USINT	1 to 63	G	RW	Not retained. Not published.

(a)	(c)	(d)	(e)	(f)	(g)	(h)	(i)	(j)
_GEM_PPFormat	Supported Process Program Formats	Specifies the process program formats supported by the equipment. 1: Process programs 2: Formatted process programs 3: Process programs and formatted process programs 4 to 15: Specification is not possible because large process programs are not supported. 16 and higher: Reserved	USINT	Depends on data type.	G	RW	Not retained.	Not published.
_GEM_PPExecName	Current Process Program	Specifies the currently selected process program.	STRING[121]	Depends on data type.	G	RW	Not retained.	Not published.

### A-2-13 Equipment Terminal Services

(a)	(c)	(d)	(e)	(f)	G	(h)	(i)	(j)
_GEM_BusyEquip-TerminalMsg	Equipment-initiated Terminal Message Transaction Processing Flag	Gives the processing status of an equipment-initiated terminal message transaction. TRUE: Processing FALSE: Not processing.	BOOL	TRUE or FALSE	G	R	Not retained.	Not published.

(a)	(c)	(d)	(e)	(f)	(g)	(h)	(i)	(j)
_GEM_EquipTerminalMsgRslt	Equipment-initiated Terminal Message Results	Gives the results of an equipment-initiated terminal message.	_sGEM_RSLT					
Rslt	Result Flag	TRUE: Normal end FALSE: Error end	BOOL	TRUE or FALSE				
RsltCode	Result Code	Gives a code that tells the result of the terminal message. 16#0000: Normal 16#0100: Transmission error*1 16#0200: Reception error*1 16#0301 to 16#033F: Same as for ACKC10.	WORD	Depends on data type.	G	R	Not retained.	Not published.

\*1. Refer to 5-1-3 Transaction Processing on page 5-6.

(a)	(c)	(d)	(e)	(f)	(g)	(h)	(i)	(j)
_GEM_BusyHostTerminalMsgSB	Host-initiated Single-block Terminal Message Transaction Processing Flag	Gives the processing status of a host-initiated single-block terminal message transaction. TRUE: Processing FALSE: Not processing.	BOOL	TRUE or FALSE	G	R	Not retained.	Not published.
_GEM_HostTerminalMsgSB_TID	Host-initiated Single-block Terminal Message Receiving Terminal Number	Gives the receiving terminal number for a host-initiated single-block terminal message.	BYTE	Depends on data type.				

(a)	(c)	(d)	(e)	(f)	(g)	(h)	(i)	(j)
_GEM_BusyHostTerminalMsgMB	Host-initiated Multi-block Terminal Message Transaction Processing Flag	Gives the processing status of a host-initiated multi-block terminal message transaction. TRUE: Processing FALSE: Not processing.	BOOL	TRUE or FALSE	G	R	Not retained.	Not published.
_GEM_HostTerminalMsgMB_TID	Host-initiated Multi-block Terminal Message Receiving Terminal Number	Gives the receiving terminal number for a host-initiated multi-block terminal message.	BYTE	Depends on data type.				

## A-2-14 Error Messages

(a)	(b)	(c)	(d)	(e)	(f)	(g)	(h)	(i)	(j)
_GEM_S9Error		S9 Errors	Gives SECS message alarm information received from the host.	_sGEM_S9ERROR					
	S9F1	Unrecognized Device ID Detection Count	Gives the number of times unrecognized devices IDs were received from the host.*1	UINT	Depends on data type.				
	S9F3	Unrecognized Stream Detection Count	Gives the number of times unrecognized stream types were received from the host.*1	UINT	Depends on data type.				
	S9F5	Unrecognized Function Detection Count	Gives the number of times unrecognized functions were received from the host.*1	UINT	Depends on data type.	G	R	Not retained.	Published.
	S9F7	Illegal Data Detection Count	Gives the number of times illegal data formats were received from the host.*1	UINT	Depends on data type.				
	S9F9	Transaction Timer Timeout Detection Count	Gives the number of times an expected reply message was not received from the host.*1	UINT	Depends on data type.				
	S9F11	Data Too Long Detection Count	Gives the number of times the equipment received data from the host that was too large to process.*1	UINT	Depends on data type.				
	S9F13	Conversation Timeout Detection Count	Gives the number of times that data was not received in time.*1	UINT	Depends on data type.	G	R	Not retained.	Published.
	S9F13_MEXP	Conversation Timeout Message	Indicates the SECS message that resulted in a conversation timeout.	STRING[7]	Depends on data type.				

\*1. After the upper limit is reached, counting continues from 1.



## A-2-15 Clock

(a)	(c)	(d)	(e)	(f)	(g)	(h)	(i)	(j)
_GEM_BusyEquip-ChangeTime	Equipment-initiated Time Change Request Transaction Processing Flag	Gives the processing status of an equipment-initiated time change transaction. TRUE: Processing FALSE: Not processing.	BOOL	TRUE or FALSE	G	R	Not retained.	Not published.

(a)	(c)	(d)	(e)	(f)	(g)	(h)	(i)	(j)
_GEM_Equip-ChangeTimeRslt	Equipment-initiated Time Change Results	Gives the results of an equipment-initiated time change.	_sGEM_RSLT					
	Rslt	Result Flag	TRUE: Normal end FALSE: Error end	BOOL	TRUE or FALSE			
RsltCode	Result Code	Gives a code that tells the result of the time change. 16#0000: Normal 16#0100: Transmission error*1 16#0200: Reception error*1 16#0300: TIME data error	WORD	Depends on data type.	G	R	Not retained.	Not published.

\*1. Refer to 5-1-3 Transaction Processing on page 5-6.

(a)	(c)	(d)	(e)	(f)	(g)	(h)	(i)	(j)
_GEM-TimeFormat	Time Format	Gives the format of time data. 0: 12-byte format Not 0: 16-byte format	USINT	Depends on data type.	G	R	Retained.	Not published.

## A-2-16 Spooling

(a)	(c)	(d)	(e)	(f)	(g)	(h)	(i)	(j)
_GEM-SpoolingState	Spooling State	Gives the spooling state. 0: FUNCTION OFF 1: SPOOL INACTIVE 2: SPOOL ACTIVE 3: SPOOL ACTIVE/SPOOL FULL	USINT	0 to 3	G	R	Not retained.	Published.

(a)	(c)	(d)	(e)	(f)	(g)	(h)	(i)	(j)
_GEM-SpoolParam	Spool Parameters	Gives the parameters for spooling.	_sGEM_SPOOL_PARAM					

(a)	(b)	(c)	(d)	(e)	(f)	(g)	(h)	(i)	(j)
Enable Spooling		Spooling Enabled Flag	Tells whether spooling is enabled. TRUE: Enabled. FALSE: Disabled.	BOOL	TRUE or FALSE	G	R	Retained.	Published.
OverWrite Spool		Overwrite Spool	Tells whether the spool is overwritten when it is full. TRUE: Overwrite. FALSE: Do not overwrite.	BOOL	TRUE or FALSE				
MaxSpoolTransmit		Max Spool Transmit	Gives the maximum number of SECS messages that can be sent from the spool.	UDINT	0 to 1000				

(a)	(b)	(c)	(d)	(e)	(f)	(g)	(h)	(i)	(j)
_GEM_Spool Condition		Spool Information	Gives information for managing the spool.	_sGEM_SPOOL_CONDITION		G	R	Not retained.	Published.
SpoolCountActual		Spool Count Actual	Gives the number of SECS messages stored on the spool.	UINT	0 to 1000				
SpoolCountTotal		Spool Count Total	Gives the total number of SECS messages that were stored on the spool.	UDINT	Depends on data type.				
SpoolFullTime		Spool Full Time	Gives the date and time at which the spool was last full.	DATE_AND_TIME	Depends on data type.				
SpoolStartTime		Spool Start Time	Gives the date and time that the spool was last started.	DATE_AND_TIME	Depends on data type.				

### A-2-17 User-defined Messages

(a)	(c)	(d)	(e)	(f)	(g)	(h)	(i)	(j)
_GEM_BusyHost UserMsg	Host-initiated User-defined Message Transaction Processing Flag	Gives the processing status of a host-initiated user-defined message transaction. TRUE: Processing FALSE: Not processing.	BOOL	TRUE or FALSE	G	R	Not retained.	Not published.
_GEM_Host UserMsgNo	Host-initiated User-defined Message Number	Gives the number of the received host-initiated user-defined message.	UINT	Depends on data type.				

(a)	(c)	(d)	(e)	(f)	(g)	(h)	(i)	(j)
_GEM_BusyEquipUserMsg	Equipment-initiated User-defined Message Transaction Processing Flag	Gives the processing status of an equipment-initiated user-defined message transaction. TRUE: Processing FALSE: Not processing.	BOOL	TRUE or FALSE	G	R	Not retained.	Not published.
_GEM_EquipUserMsgNo	Equipment-initiated User-defined Message Number	Gives the number of a received equipment-initiated user-defined message.	UINT	Depends on data type.	G	R	Not retained.	Not published.

(a)	(c)	(d)	(e)	(f)	(g)	(h)	(i)	(j)
_GEM_EquipUserMsgRslt	Send Equipment-initiated User-defined Message Result	Gives the results of sending an equipment-initiated user-defined message.	_sGEM_RSLT					
	Rslt	Result Flag	TRUE: Normal end FALSE: Error end	BOOL	TRUE or FALSE			
	RsltCode	Result Code	Gives a code that tells the result of the user-defined message. 16#0000: Normal 16#0100: Transmission error*1 16#0200: Reception error*1	WORD	Depends on data type.	G	R	Not retained. Not published.

\*1. Refer to 5-1-3 Transaction Processing on page 5-6.

## A-3 Correspondence between Formats and Data Types

---

The meanings of the formats used in the items and variable data and the corresponding data types used in an NJ-series CPU Unit are given in the following table.

Format	Meaning	Corresponding data type
B	Binary	BYTE
U1	1-byte unsigned integer	USINT
U2	2-byte unsigned integer	UINT
U4	4-byte unsigned integer	UDINT
I1	1-byte signed integer	SINT
I2	2-byte signed integer	INT
I4	4-byte signed integer	DINT
F4	4-byte floating point number	REAL
F8	8-byte floating point number	LREAL
A	ASCII	STRING
BOOLEAN	Logic value	BOOL

# A-4 Designing Tasks to Use the GEM Services

When you design tasks to use the GEM Services, you must consider the GEM Service startup time and the communications performance for GEM instructions.

Refer to the *NJ/NX-series CPU Unit Software User's Manual* (Cat. No. W501) for the task operation specifications and system service operation specifications of the NJ-series Controllers.

## A-4-1 GEM Service Startup Time

The time required for the GEM Service status to change to Run after the power supply to the SECS/GEM CPU Unit is turned ON is called the startup time. It depends on the task execution time ratio. The task execution time ratio is the ratio between the set task period and the task execution time. You can check the set task period and the task execution time with the Task Execution Time Monitor on the Sysmac Studio. Refer to *A-4-3 Checking the Task Execution Time Ratio* on page A-234 for details on checking the task execution time ratio.

The following table gives guidelines for the GEM Service startup time. The GEM Service startup time increases with the task execution time ratio. If the GEM Service startup time reaches 60 s or longer, an error occurs in the GEM Services.

Task execution time ratio [%]	Average startup time of GEM Services [s]
20	18.1
50	20.6
80	38.6

The above values are the results of actual measurements. The measurement conditions are given in the following table.

Item	Measurement condition
Task configuration	Primary periodic task only
Task period [ms]	1
Unit configuration	No CJ-series Units
Network configuration	<ul style="list-style-type: none"> <li>• No EtherCAT connection</li> <li>• No HMI connection</li> <li>• No connections to other Controllers</li> <li>• Connection to Sysmac Studio through Ethernet</li> </ul>

The time required for the operating mode to change to RUN mode after the power supply is turned ON to the SECS/GEM CPU Unit is the same as for NJ-series Standard CPU Units.



### Precautions for Correct Use

As a guideline, design the tasks so that the task execution time ratio is 80% or lower. Always use the actual system to confirm the GEM Service startup time under all possible conditions.

Startup processing for the GEM Services is performed by the system services. Therefore, if other processing is performed by the system services, the GEM Service startup time may exceed the design value.

## A-4-2 Communications Performance of GEM Instructions

The communications performance of the GEM instructions depends on the task execution time ratio and the size of the SECS message send data.

You can consecutively execute GEM instructions even before the SECS messages have been sent. If you consecutively execute GEM instructions before the SECS message are sent, the SECS messages to send are buffered in the send buffer of the GEM Services. If the volume of the SECS messages exceeds the send buffer capacity, GEM instructions will end in errors. Therefore, use the following reference values to design the tasks and user program.

### Task Execution Time Ratio and GEM Instruction Communications Performance

The communications performance of the GEM instruction decreases as the task execution time ratio increases. The following table provides reference values for the SECS message send interval when the Report Event (GEM\_ReportEvent) instruction is executed consecutively.

Task execution time ratio [%]	SECS message average send interval for consecutive GEM_ReportEvent instruction execution [ms]
20	73
30	83
40	100
50	128
60	160
70	243
80	424

The above values are the results of actual measurements. The measurement conditions are given in the following table.

Item	Measurement condition
Task configuration	Primary periodic task only
Task period [ms]	1
Unit configuration	No CJ-series Units
Network configuration	<ul style="list-style-type: none"> <li>• No EtherCAT connection</li> <li>• No HMI connection</li> <li>• No connections to other Controllers</li> <li>• Connection to Sysmac Studio through Ethernet</li> </ul>
Sent SECS messages	Event Report Send (S6,F11)
Sent data size [bytes]	17

## Size of SECS Message Send Data and Communications Performance of GEM Instructions

The communications performance of the GEM instruction decreases as the size of the SECS message send data increases. The following table provides reference values for the SECS message send interval when the Event Report (GEM\_ReportEvent) instruction is executed consecutively.

Sent data size [bytes]	SECS message average send interval for consecutive GEM_ReportEvent instruction execution [ms]
17	73
30K	154

The above values are the results of actual measurements. The measurement conditions are given in the following table.

Item	Measurement condition
Task configuration	Primary periodic task only
Task period [ms]	1
Task execution time ratio [%]	20
Unit configuration	No CJ-series Units
Network configuration	<ul style="list-style-type: none"> <li>• No EtherCAT connection</li> <li>• No HMI connection</li> <li>• No connections to other Controllers</li> <li>• Connection to Sysmac Studio through Ethernet</li> </ul>
Sent SECS messages	Event Report Send (S6,F11)



### Precautions for Correct Use

Always use the actual system to confirm the GEM instruction communications performance under all possible conditions. GEM instruction processing is performed by the system services. Therefore, if other processing is performed by the system services, the GEM instruction communications performance may be lower than the design value.

### A-4-3 Checking the Task Execution Time Ratio

You can check the task execution time ratio in the Task Execution Time Monitor of the Sysmac Studio. Refer to the *Sysmac Studio Version 1 Operation Manual* (Cat. No. W504) for operating procedures for the Task Execution Time Monitor.

The task execution time ratio is calculated with the following formula.

$$\text{Task execution time ratio [\%]} = \text{Average value of task execution time [s]} \div \text{Set task period [s]} \times 100$$

For example, if the Task Execution Time Monitor displays the following values, the task execution time ratio is approx. 28.9%.

$$\text{Task execution time ratio [\%]} = 288.9 \mu\text{s} / 1,000 \mu\text{s} \times 100 = 28.9\%$$

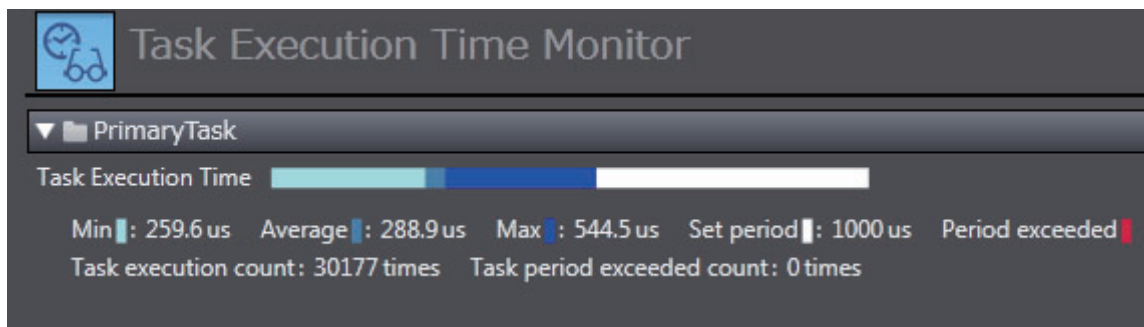



# A-5 Basic Specifications, Performance Specifications, and Functional Specifications

Refer to the following manual or sections for the basic specifications, performance specifications, and function specifications of the SECS/GEM CPU Unit.

Specifications		Reference
Basic specifications		<i>NJ/NX-series CPU Unit Software User's Manual (Cat. No. W501)</i>
Performance specifications		
Functional specifications	Functions shared with NJ-series CPU Units	
	SECS/GEM standard functions supported by the SECS/GEM CPU Unit	<i>1-2 Standard Compliance of the SECS/GEM CPU Unit on page 1-4</i>
	GEM Services	<i>2-1 System Configuration on page 2-2</i>

# A-6 Version Information

There are six types of versions of the hardware and software related to the SECS/GEM CPU Unit:

- Unit version
- GEM Service version
- SECS/GEM Configurator version
- Log Viewer version
- Version of a project that is created by the SECS/GEM Configurator
- Sysmac Studio version

This appendix describes how to check these versions, how they are related to each other, and what to note on the versions.

## A-6-1 Checking Versions

The checking methods of versions are given in the following table.

Type	How to check
Unit version	<ul style="list-style-type: none"> <li>• ID information indication on the SECS/GEM CPU Unit</li> <li>• Production Information on the Sysmac Studio</li> </ul> Refer to <i>Versions</i> on page 21 for details.
GEM Service version	<ul style="list-style-type: none"> <li>• ID information indication on the SECS/GEM CPU Unit</li> <li>• Production Information on the Sysmac Studio</li> <li>• System-defined variable: <i>_GEM_Version</i></li> </ul> Refer to <i>Versions</i> on page 21 and <i>A-2-1 GEM Service Version</i> on page A-212 for details.
SECS/GEM Configurator version	<ul style="list-style-type: none"> <li>• About Software under the Help Menu on the SECS/GEM Configurator</li> <li>• Title bar of the SECS/GEM Configurator</li> </ul> Refer to <i>About Software</i> on page 8-35 for details.
Log Viewer version	<ul style="list-style-type: none"> <li>• Help on the Log Viewer</li> </ul> Refer to <i>6-3-12 Help</i> on page 6-22 for details.
Project version	<ul style="list-style-type: none"> <li>• Open under the File Menu on the SECS/GEM Configurator</li> <li>• GEM Service Operation under the Controller Menu on the SECS/GEM Configurator</li> </ul> Refer to <i>Open</i> on page 8-17 and <i>GEM Service Operation</i> on page 8-25 for details.
Sysmac Studio version	<ul style="list-style-type: none"> <li>• About Sysmac Studio under File Menu on of the Sysmac Studio</li> </ul> Refer to the <i>Sysmac Studio Version 1 Operation Manual</i> (Cat. No. W504) for details.

## A-6-2 Relationship between Unit Version and GEM Service Version

The relationship between the unit version of the SECS/GEM CPU Unit and the GEM Service version is given in the following table.

Unit version	GEM Service version
Ver.1.09	Ver.1.00
Ver.1.10	
Ver.1.11 or later	Ver.1.01



**Precautions for Correct Use**

If you use the backup functions between different CPU Units, the backup data may not be compatible depending on the unit version of the CPU Unit and GEM Service version of the backup source and the unit version of the CPU Unit and GEM Service version of the restore destination. Refer to 7-2-5 *Compatibility between Versions of CPU Units* on page 7-6 for details on the compatibility of backup data between different CPU Unit versions.

**A-6-3 Relationship between Unit Version and Sysmac Studio Version**

Each unit version of the SECS/GEM CPU Unit has a corresponding Sysmac Studio version. You cannot use any combinations other than the corresponding combinations.

Ask your OMRON representative about the Sysmac Studio versions that you can use with each unit version of the SECS/GEM CPU Units.

**A-6-4 Combinations of Versions That Require Attention and How to Deal with Them**

You need to pay attention to the following combinations of versions. You cannot use them if the combinations of versions are not correspondence.

- GEM Service version and SECS/GEM Configurator version
- SECS/GEM Configurator version and project version

**GEM Service Version and SECS/GEM Configurator Version**

For the possible combinations of the GEM Service version and SECS/GEM Configurator version, availability is shown in the following table.

GEM Service version	SECS/GEM Configurator version	
	Ver.1.01	Ver.1.00
Ver.1.01	Can be used.	Cannot be used.
Ver.1.00	Cannot be used.	Can be used.

If the combination of the GEM Service version and SECS/GEM Configurator version cannot be used, an error message is displayed when you transfer the GEM setting data between the SECS/GEM CPU Unit and the SECS/GEM Configurator.

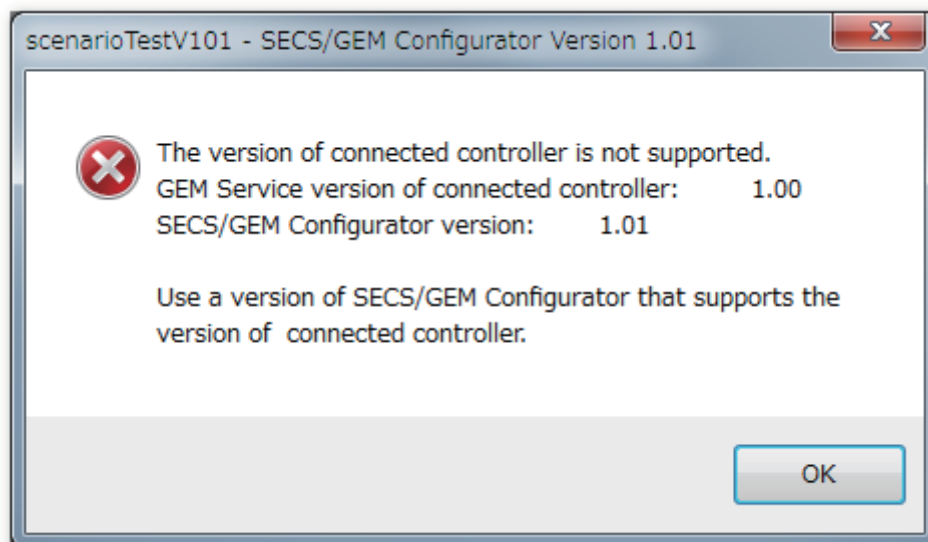

In this case, replace either of the SECS/GEM CPU Unit and the SECS/GEM Configurator so that the combination of their versions can be used.

## Between SECS/GEM Configurator Version and Project Version

The version of a project will be the same as the version of the SECS/GEM Configurator where the project is created. Therefore, a difference in versions of the SECS/GEM Configurator and a project indicates that the version of the SECS/GEM Configurator where its project was created is different from the version of the currently used SECS/GEM Configurator.

For the possible combinations of the SECS/GEM Configurator version and project version, availability is shown in the following table.

SECS/GEM Configurator version	Project version	
	Ver.1.01	Ver.1.00
Ver.1.01	Can be used.	Cannot be used.
Ver.1.00	Cannot be used.	Can be used.

If the combination of the SECS/GEM Configurator version and project version cannot be used, an error message is displayed on the computer when you open the project on the SECS/GEM Configurator. The error message that displayed and its corrective action depend on which version is earlier between the project to open and the SECS/GEM Configurator.

- **When the Version of a Project to Open Is Earlier Than the Version of the SECS/GEM Configurator**

When the version of a project to open is earlier than the version of the SECS/GEM Configurator, an error message is displayed as shown below.

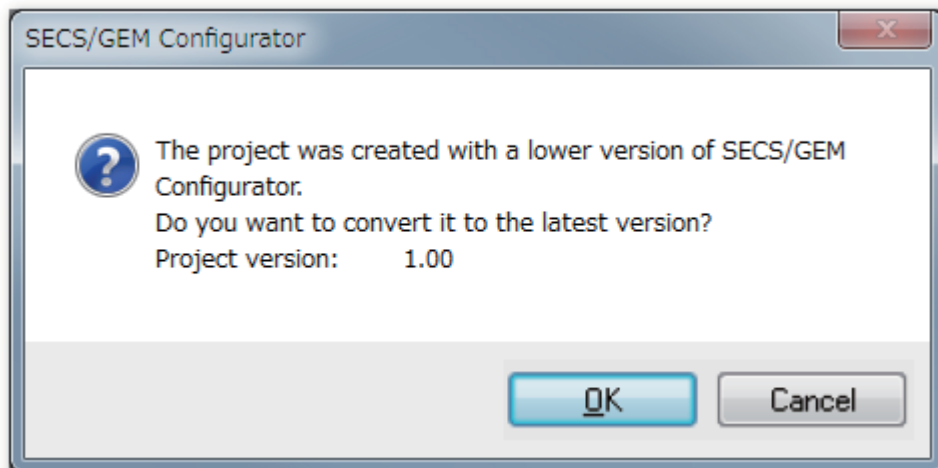

If you click **OK** Button, the version of the project is updated to correspond to the version of the SECS/GEM Configurator.

If you click the **Cancel** Button, the processing to open the project is interrupted.

- **When the Version of the SECS/GEM Configurator Is Earlier Than the Version of a Project to Open**

When the version of the SECS/GEM Configurator is earlier than the version of a project to open, an error message is displayed as shown below.

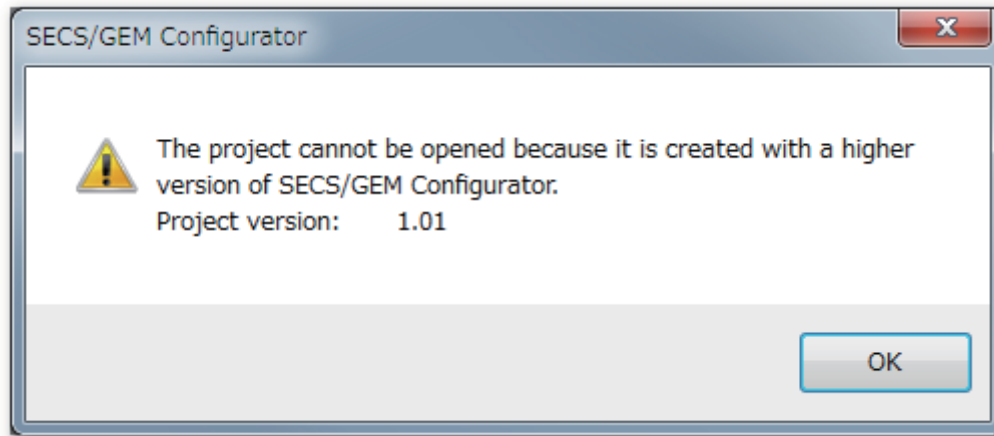

In this case, replace the SECS/GEM Configurator so that the combination of their versions can be used.





# Index



# Index

---

## A

---

Acknowledge Enhanced Remote Command ..... A-60  
 Acknowledge Equipment Constant Change ..... A-71  
 Acknowledge Formatted Process Program Download A-115  
 Acknowledge Host Command ..... A-50  
 Acknowledge Multi-block Equipment Terminal  
 Message ..... A-165  
 Acknowledge Process Program Deletion ..... A-76  
 Acknowledge Single-block Equipment Terminal  
 Message ..... A-160  
 Acknowledge Process Program Download ..... A-125  
 alarm management ..... 5-53  
 assumed cause ..... 9-3

## B

---

backup functions ..... 7-5  
 built-in EtherCAT port ..... 2-3  
 built-in EtherNet/IP port ..... 2-3

## C

---

Change Communications State ..... A-25  
 Change Control State ..... A-32  
 Change Equipment Constant ..... A-65  
 clock ..... 5-91  
 Communications State ..... A-218  
 communications state model ..... 5-27  
 Control GEM Service Status ..... A-10  
 Control State ..... A-218  
 Control State Interlock ..... A-215  
 control state model ..... 5-31  
 Control State Parameters ..... A-219  
 controller variable ..... 23  
 Controller Variable command ..... 8-27  
 Current Process Program ..... A-224

## D

---

Default Communications State ..... A-218  
 detail view of SECS message log ..... 6-14  
 documentation ..... 5-44  
 dynamic event report configuration ..... 5-45

## E

---

Enhanced Remote Command Interlock ..... A-215  
 Enhanced Remote Command Transaction Processing  
 Flag ..... A-220  
 enhanced remote commands ..... 5-60  
 EQInitializing ..... 4-4  
 EQRun ..... 4-4  
 EQStarting ..... 4-4

equipment ..... 2-2  
 Equipment Constant Interlock ..... A-215  
 equipment constants ..... 5-62  
 Equipment Information ..... A-212  
 equipment processing states ..... 5-37  
 equipment terminal service ..... 5-88  
 Equipment-initiated Formatted Process Program Download  
 Results ..... A-222  
 Equipment-initiated Formatted Process Program Download  
 Transaction Processing Flag ..... A-222  
 Equipment-initiated Formatted Process Program Upload Re-  
 sults ..... A-221  
 Equipment-initiated Formatted Process Program Upload  
 Transaction Processing Flag ..... A-220  
 Equipment-initiated Message Bufferings ..... A-214  
 Equipment-Initiated Process Program Download  
 Results ..... A-223  
 Equipment-initiated Process Program Download Transaction  
 Processing Flag ..... A-223  
 Equipment-Initiated Process Program Upload Results A-221  
 Equipment-initiated Process Program Upload Transaction  
 Processing Flag ..... A-221  
 Equipment-initiated Terminal Message Results ..... A-224  
 Equipment-initiated Terminal Message Transaction Process-  
 ing Flag ..... A-224  
 Equipment-initiated Time Change Request Transaction Pro-  
 cessing Flag ..... A-227  
 Equipment-initiated Time Change Results ..... A-227  
 Equipment-initiated User-defined Message Number . A-229  
 Equipment-initiated User-defined Message Transaction Pro-  
 cessing Flag ..... A-229  
 Error ..... 4-4  
 error descriptions ..... 9-5  
 error messages ..... 5-43  
 event code ..... 9-3  
 event name ..... 9-3  
 event notification ..... 5-40  
 execution log ..... 6-2

## F

---

filters ..... 6-18

## G

---

GEM ..... 23  
 GEM capability ..... 23, 5-26  
 GEM instruction ..... 23  
 GEM Service logs ..... 23  
 GEM Service Status ..... A-212  
 GEM Service version ..... 19  
 GEM Services ..... 23  
 \_GEM\_ServiceStatus (GEM Service Status) ..... A-212  
 GEM setting data ..... 23  
 GEM Setting Tool ..... 23



- GEM Setting Tools .....2-3
- GEM standard messages .....5-102
- GEM Version ..... A-212
- GEM\_AckChangeECV (Acknowledge Equipment Constant Change) ..... A-71
- GEM\_AckEnhancedRmtCmd (Acknowledge Enhanced Remote Command) ..... A-60
- GEM\_AckFormattedPPDownload (Acknowledge Formatted Process Program Download) ..... A-115
- GEM\_AckHostCmd (Acknowledge Host Command) ... A-50
- GEM\_AckPPDelete (Acknowledge Process Program Deletion) ..... A-76
- GEM\_AckPPDownload (Acknowledge Process Program Download) ..... A-125
- GEM\_AckTerminalMsgMB (Acknowledge Multi-block Equipment Terminal Message) ..... A-165
- GEM\_AckTerminalMsgSB (Acknowledge Single-block Equipment Terminal Message) ..... A-160
- \_GEM\_BusyEnhancedRmtCmd (Enhanced Remote Command Transaction Processing Flag) ..... A-220
- \_GEM\_BusyEquipChangeTime (Equipment-initiated Time Change Request Transaction Processing Flag) ..... A-227
- \_GEM\_BusyEquipFormattedPPDownload (Equipment-initiated Formatted Process Program Download Transaction Processing Flag) ..... A-222
- \_GEM\_BusyEquipFormattedPPUpload (Equipment-initiated Formatted Process Program Upload Transaction Processing Flag) ..... A-220
- \_GEM\_BusyEquipPPDownload (Equipment-initiated Process Program Download Transaction Processing Flag) ..... A-223
- \_GEM\_BusyEquipPPUpload (Equipment-initiated Process Program Upload Transaction Processing Flag) ..... A-221
- \_GEM\_BusyEquipTerminalMsg (Equipment-initiated Terminal Message Transaction Processing Flag) ..... A-224
- \_GEM\_BusyEquipUserMsg (Equipment-initiated User-defined Message Transaction Processing Flag) ..... A-229
- \_GEM\_BusyHostChangeECV (Host-initiated Equipment Constant Change Transaction Processing Flag) ..... A-220
- \_GEM\_BusyHostCmd (Host Command Transaction Processing Flag) ..... A-219
- \_GEM\_BusyHostFormattedPPDownload (Host-initiated Formatted Process Program Download Transaction Processing Flag) ..... A-222
- \_GEM\_BusyHostFormattedPPUpload (Host-initiated Formatted Process Program Upload Transaction Processing Flag) ..... A-220
- \_GEM\_BusyHostPPDelete (Host-initiated Process Program Deletion Transaction Processing Flag) ..... A-220
- \_GEM\_BusyHostPPDownload (Host-initiated Process Program Download Transaction Processing Flag) ..... A-222
- \_GEM\_BusyHostPPUpload (Host-initiated Process Program Upload Transaction Processing Flag) ..... A-220
- \_GEM\_BusyHostTerminalMsgMB (Host-initiated Multi-block Terminal Message Transaction Processing Flag) ... A-225
- \_GEM\_BusyHostTerminalMsgSB (Host-initiated Single-block Terminal Message Transaction Processing Flag) ... A-225
- \_GEM\_BusyHostUserMsg (Host-initiated User-defined Message Transaction Processing Flag) ..... A-228
- GEM\_ChangeCommState (Change Communications State) ..... A-25
- GEM\_ChangeControlState (Change Control State) .... A-32
- GEM\_ChangeECV (Change Equipment Constant) .... A-65
- \_GEM\_CommLog (SECS Communications Log) ..... A-213
- \_GEM\_CommLogCnt (SECS Communications Log Count) ..... A-213
- \_GEM\_CommunicationsState (Communications State) ..... A-218
- GEM\_ControlService (Control GEM Service Status) ... A-10
- \_GEM\_ControlState (Control State) ..... A-218
- \_GEM\_ControlStateParam (Control State Parameters) ..... A-219
- \_GEM\_DefaultCommunicationsState (Default Communications State) ..... A-218
- \_GEM\_EquipChangeTimeRsIt (Equipment-initiated Time Change Results) ..... A-227
- \_GEM\_EquipFormattedPPDownloadRsIt (Equipment-initiated Formatted Process Program Download Results) A-222
- \_GEM\_EquipFormattedPPUploadRsIt (Equipment-initiated Formatted Process Program Upload Results) ..... A-221
- \_GEM\_EquipInfo (Equipment Information) ..... A-212
- \_GEM\_EquipMsgBuf (Equipment-initiated Message Bufferings) ..... A-214
- \_GEM\_EquipPPDownloadRsIt (Equipment-Initiated Process Program Download Results) ..... A-223
- \_GEM\_EquipPPUploadRsIt (Equipment-Initiated Process Program Upload Results) ..... A-221
- \_GEM\_EquipTerminalMsgRsIt (Equipment-initiated Terminal Message Results) ..... A-224
- \_GEM\_EquipUserMsgNo (Equipment-initiated User-defined Message Number) ..... A-229
- \_GEM\_EquipUserMsgRsIt (Send Equipment- ..... A-229
- \_GEM\_EstablishCommunicationsTimeout (Establish Communications Timeout) ..... A-218
- GEM\_GetCommLog (Get SECS Communications Log) A-17
- \_GEM\_HostMsgBuf (Host-initiated Message Bufferings) ..... A-214
- \_GEM\_HostTerminalMsgMB\_TID (Host-initiated Multi-block Terminal Message Receiving Terminal Number) .... A-225
- \_GEM\_HostTerminalMsgSB\_TID (Host-initiated Single-block Terminal Message Receiving Terminal Number) .... A-225
- \_GEM\_HostUserMsgNo (Host-initiated User-defined Message Number) ..... A-228
- \_GEM\_HSMSError (HSMS Communications Errors) A-216
- \_GEM\_HSMSParm (HSMS Communications Parameters) ..... A-216
- \_GEM\_HSMSSState (HSMS Communications State) . A-215
- GEM\_InitEvent (Initialize Events) ..... A-38
- \_GEM\_Interlock\_ControlState (Control State Interlock) ..... A-215
- \_GEM\_Interlock\_ECV (Equipment Constant Interlock) A-215
- \_GEM\_Interlock\_EnhancedRmtCmd (Enhanced Remote Command Interlock) ..... A-215
- \_GEM\_Interlock\_HostCmd (Host Command Interlock) A-215
- \_GEM\_Interlock\_PP (Process Program Interlock) .... A-215
- \_GEM\_Interlock\_Time (Time Change Interlock) ..... A-215
- \_GEM\_OperatorCommand (Operator Command) .... A-219
- \_GEM\_PPChangeInfo (Process Program Change Informa-

tion) ..... A-223  
 \_GEM\_PPExecName (Current Process Program) ..... A-224  
 \_GEM\_PPFormat (Supported Process Program Formats) ..... A-224  
 \_GEM\_PreviousProcessState (Previous Processing State) ..... A-218  
 \_GEM\_ProcessState (Processing State) ..... A-218  
 GEM\_ReportAlarm (Report Alarm) ..... A-45  
 GEM\_ReportEvent (Report Event) ..... A-41  
 GEM\_RequestChangeTime (Request Time Change) A-171  
 GEM\_RequestFormattedPPDownload (Request Formatted Process Program Download) ..... A-132  
 GEM\_RequestPPDownload (Request Process Program Download) ..... A-142  
 GEM\_RespFormattedPPUpload (Respond to Formatted Process Program Upload) ..... A-82  
 GEM\_RespHostUserMsg (Respond to Host-initiated User-defined Message) ..... A-182  
 GEM\_RespPPUpload (Respond to Process Program Upload) ..... A-91  
 \_GEM\_S9Error (S9 Errors) ..... A-226  
 GEM\_SendEquipUserMsg (Send Equipment-initiated User-defined Message) ..... A-175  
 GEM\_SendPPVerify (Send Process Program Verification Result) ..... A-151  
 GEM\_SendTerminalMsg (Send Equipment Terminal Message) ..... A-155  
 GEM\_SetHSMSParam (Set HSMS Communications Parameters) ..... A-20  
 GEM\_Shutdown (Shutdown GEM Service) ..... A-14  
 \_GEM\_SpoolCondition (Spool Information) ..... A-228  
 \_GEM\_SpoolingState (Spooling State) ..... A-227  
 \_GEM\_SpoolParam (Spool Parameters) ..... A-227  
 \_GEM\_TimeFormat (Time Format) ..... A-227  
 GEM\_UploadFormattedPP (Upload Formatted Process Program) ..... A-98  
 GEM\_UploadPP (Upload Process Program) ..... A-107  
 \_GEM\_Version (GEM Version) ..... A-212  
 Get SECS Communications Log ..... A-17

**H**

host ..... 23, 2-2  
 Host Command Interlock ..... A-215  
 Host Command Transaction Processing Flag ..... A-219  
 host commands ..... 5-56  
 host connection function ..... 23  
 Host-initiated Equipment Constant Change Transaction Processing Flag ..... A-220  
 Host-initiated Formatted Process Program Download Transaction Processing Flag ..... A-222  
 Host-initiated Formatted Process Program Upload Transaction Processing Flag ..... A-220  
 Host-initiated Message Bufferings ..... A-214  
 Host-initiated Multi-block Terminal Message Receiving Terminal Number ..... A-225  
 Host-initiated Multi-block Terminal Message Transaction Processing Flag ..... A-225  
 Host-initiated Process Program Deletion Transaction Pro-

cessing Flag ..... A-220  
 Host-initiated Process Program Download Transaction Processing Flag ..... A-222  
 Host-initiated Process Program Upload Transaction Processing Flag ..... A-220  
 Host-initiated Single-block Terminal Message Receiving Terminal Number ..... A-225  
 Host-initiated Single-block Terminal Message Transaction Processing Flag ..... A-225  
 Host-initiated User-defined Message Number ..... A-228  
 Host-initiated User-defined Message Transaction Processing Flag ..... A-228  
 HSMS ..... 23  
 HSMS communications ..... 5-14  
 HSMS Communications Errors ..... A-216  
 HSMS communications log ..... 6-2  
 HSMS Communications Parameters ..... A-216  
 HSMS Communications State ..... A-215

**I**

Idle ..... 4-4  
 Initialize Events ..... A-38  
 Initializing ..... 4-4  
 interlocks ..... 5-5  
 item definitions ..... 5-17

**L**

limit monitoring ..... 5-93  
 link variable ..... 23  
 link variables ..... 2-14  
 list view of SECS message log ..... 6-12  
 Log Viewer ..... 23, 6-6

**M**

message settings ..... 5-102

**O**

Operator Command ..... A-219  
 outputting logs to files ..... 6-19

**P**

Previous Processing State ..... A-218  
 primary message ..... 23  
 Process Program Change Information ..... A-223  
 Process Program Interlock ..... A-215  
 process program management ..... 5-66  
 Processing State ..... A-218

**R**

Report Alarm ..... A-45  
 Report Event ..... A-41  
 Request Formatted Process Program Download ..... A-132  
 Request Process Program Download ..... A-142

Request Time Change .....	A-171
Respond to Formatted Process Program Upload .....	A-82
Respond to Host-initiated User-defined Message .....	A-182
Respond to Process Program Upload .....	A-91
Run .....	4-4

## S

S9 Errors .....	A-226
SD Memory Cards .....	2-3, 7-2
secondary message .....	23
SECS .....	23
SECS Communications Log .....	A-213
SECS Communications Log Count .....	A-213
SECS message log .....	6-2
SECS/GEM .....	23
SECS/GEM Configurator .....	23
SECS/GEM CPU Unit .....	2-2
SECS/GEM operation programming .....	3-3
SECS-II .....	23
SEMI .....	24
Send Equipment- initiated User-defined Message	
Result .....	A-229
Send Equipment Terminal Message .....	A-155
Send Equipment-initiated User-defined Message .....	A-175
Send Process Program Verification Result .....	A-151
Set HSMS Communications Parameters .....	A-20
Shutdown .....	4-4
shutdown .....	4-3
Shutdown GEM Service .....	A-14
ShuttingDown .....	4-4
Spool Information .....	A-228
Spool Parameters .....	A-227
spooling .....	5-96
Spooling State .....	A-227
status data collection .....	5-51
Stop .....	4-4
stream and function .....	24
summary view of SECS message log .....	6-13
Supported Process Program Formats .....	A-224
Sysmac Studio .....	2-4
system configuration .....	2-2

## T

Time Change Interlock .....	A-215
Time Format .....	A-227
trace data collection .....	5-49

## U

unit version .....	19
Upload Formatted Process Program .....	A-98
Upload Process Program .....	A-107
UPS .....	2-4
user-defined messages .....	5-104

## V

variable data collection .....	5-48
variable data definitions .....	5-21
version .....	19





**OMRON Corporation Industrial Automation Company**  
Kyoto, JAPAN

Contact: [www.ia.omron.com](http://www.ia.omron.com)

**Regional Headquarters**

**OMRON EUROPE B.V.**

Wegalaan 67-69, 2132 JD Hoofddorp  
The Netherlands  
Tel: (31)2356-81-300/Fax: (31)2356-81-388

**OMRON ASIA PACIFIC PTE. LTD.**

438B Alexandra Road, #08-01/02 Alexandra  
Technopark, Singapore 119968  
Tel: (65) 6835-3011/Fax: (65) 6835-2711

**OMRON ELECTRONICS LLC**

2895 Greenspoint Parkway, Suite 200  
Hoffman Estates, IL 60169 U.S.A.  
Tel: (1) 847-843-7900/Fax: (1) 847-843-7787

**OMRON (CHINA) CO., LTD.**

Room 2211, Bank of China Tower,  
200 Yin Cheng Zhong Road,  
PuDong New Area, Shanghai, 200120, China  
Tel: (86) 21-5037-2222/Fax: (86) 21-5037-2200

**Authorized Distributor:**

© OMRON Corporation 2014-2022 All Rights Reserved.  
In the interest of product improvement,  
specifications are subject to change without notice.

**Cat. No. W528-E1-05**

0622